

**VERMONT MUNICIPAL EMPLOYEES
INVESTMENT PERFORMANCE ANALYSIS
SEPTEMBER 30, 2005**

VERMONT MUNICIPAL EMPLOYEES
TOTAL FUND ASSET GROWTH SUMMARY (\$000)
PERIODS ENDING 9/05

MUNICIPAL SYSTEM COMPOSITE

	<u>LAST QUARTER</u>	<u>YEAR TO DATE</u>	<u>LAST 12 MONTHS</u>	<u>SINCE INCEPTION 3/01</u>
BEGINNING MARKET VALUE	245,739	239,747	221,740	163,148
NET EXTERNAL GROWTH	1,241	4,788	6,965	30,754
RETURN ON INVESTMENT	9,895	12,340	28,170	62,973
INCOME RECEIVED	3,057	4,379	9,857	21,457
GAIN/LOSS	6,838	7,961	18,313	41,516
ENDING MARKET VALUES	256,875	256,875	256,875	256,875

VERMONT MUNICIPAL EMPLOYEES
TOTAL FUND ASSET GROWTH SUMMARY (\$000)
PERIODS ENDING 9/05

DOMESTIC EQUITY COMPOSITE

	<u>LAST QUARTER</u>	<u>YEAR TO DATE</u>	<u>LAST 12 MONTHS</u>	<u>SINCE INCEPTION 3/01</u>
BEGINNING MARKET VALUE	107,582	107,767	96,296	65,832
NET EXTERNAL GROWTH	- 51	- 143	1,812	18,387
RETURN ON INVESTMENT	5,792	5,699	15,215	29,104
INCOME RECEIVED	1,925	2,384	6,721	9,748
GAIN/LOSS	3,867	3,315	8,495	19,356
ENDING MARKET VALUES	113,323	113,323	113,323	113,323

VERMONT MUNICIPAL EMPLOYEES
TOTAL FUND ASSET GROWTH SUMMARY (\$000)
PERIODS ENDING 9/05

DELAWARE

	<u>LAST QUARTER</u>	<u>YEAR TO DATE</u>	<u>LAST 12 MONTHS</u>	<u>SINCE INCEPTION 6/00</u>
BEGINNING MARKET VALUE	41,980	41,975	38,601	24,252
NET EXTERNAL GROWTH	0	0	0	5,077
RETURN ON INVESTMENT	1,112	1,116	4,490	13,762
INCOME RECEIVED	234	694	900	3,326
GAIN/LOSS	877	422	3,589	10,436
ENDING MARKET VALUES	43,091	43,091	43,091	43,091

VERMONT MUNICIPAL EMPLOYEES
TOTAL FUND ASSET GROWTH SUMMARY (\$000)
PERIODS ENDING 9/05

ALLIANCE LARGE CAP GROWTH FUND

	<u>LAST QUARTER</u>	<u>YEAR TO DATE</u>	<u>LAST 12 MONTHS</u>	<u>SINCE INCEPTION 6/00</u>
BEGINNING MARKET VALUE	39,505	39,569	34,225	35,650
NET EXTERNAL GROWTH	0	0	2,000	12,500
RETURN ON INVESTMENT	3,406	3,341	6,685	-5,239
INCOME RECEIVED	0	0	0	17
GAIN/LOSS	3,406	3,341	6,685	-5,256
ENDING MARKET VALUES	42,910	42,910	42,910	42,910

VERMONT MUNICIPAL EMPLOYEES
TOTAL FUND ASSET GROWTH SUMMARY (\$000)
PERIODS ENDING 9/05

LAZARD SMALL CAP FUND

	<u>LAST QUARTER</u>	<u>YEAR TO DATE</u>	<u>LAST 12 MONTHS</u>	<u>SINCE INCEPTION 6/00</u>
BEGINNING MARKET VALUE	26,098	26,223	23,469	13,335
NET EXTERNAL GROWTH	- 51	- 143	- 188	810
RETURN ON INVESTMENT	1,275	1,241	4,040	13,176
INCOME RECEIVED	1,690	1,690	5,820	6,405
GAIN/LOSS	- 416	- 449	- 1,780	6,771
ENDING MARKET VALUES	27,322	27,322	27,322	27,322

VERMONT MUNICIPAL EMPLOYEES
TOTAL FUND ASSET GROWTH SUMMARY (\$000)
PERIODS ENDING 9/05

BRINSON - UBS

	<u>LAST QUARTER</u>	<u>YEAR TO DATE</u>	<u>LAST 12 MONTHS</u>	<u>SINCE INCEPTION 6/00</u>
BEGINNING MARKET VALUE	39,348	41,888	36,639	26,395
NET EXTERNAL GROWTH	0	- 2,000	- 2,000	6,453
RETURN ON INVESTMENT	3,531	2,991	8,240	10,032
INCOME RECEIVED	0	- 4	- 4	2
GAIN/LOSS	3,531	2,995	8,244	10,030
ENDING MARKET VALUES	42,880	42,880	42,880	42,880

VERMONT MUNICIPAL EMPLOYEES
TOTAL FUND ASSET GROWTH SUMMARY (\$000)
PERIODS ENDING 9/05

MET LIFE / SSR TOWER FUND

	<u>LAST QUARTER</u>	<u>YEAR TO DATE</u>	<u>LAST 12 MONTHS</u>	<u>SINCE INCEPTION 6/00</u>
BEGINNING MARKET VALUE	17,668	14,404	14,106	11,355
NET EXTERNAL GROWTH	- 50	1,859	1,817	1,440
RETURN ON INVESTMENT	942	2,296	2,636	5,764
INCOME RECEIVED	0	0	0	1,399
GAIN/LOSS	942	2,296	2,636	4,365
ENDING MARKET VALUES	18,559	18,559	18,559	18,559

VERMONT MUNICIPAL EMPLOYEES
TOTAL FUND ASSET GROWTH SUMMARY (\$000)
PERIODS ENDING 9/05

SEIX CORE

	<u>LAST QUARTER</u>	<u>YEAR TO DATE</u>	<u>LAST 12 MONTHS</u>	<u>SINCE INCEPTION 6/00</u>
BEGINNING MARKET VALUE	67, 472	62, 842	61, 797	53, 366
NET EXTERNAL GROWTH	1, 000	4, 000	4, 500	- 4, 461
RETURN ON INVESTMENT	- 480	1, 149	1, 695	19, 086
INCOME RECEIVED	913	1, 873	2, 196	8, 210
GAIN/LOSS	- 1, 394	- 724	- 502	10, 876
ENDING MARKET VALUES	67, 991	67, 991	67, 991	67, 991

VERMONT MUNICIPAL EMPLOYEES
TOTAL FUND ASSET GROWTH SUMMARY (\$000)
PERIODS ENDING 9/05

SEIX HIGH YIELD

	<u>LAST QUARTER</u>	<u>YEAR TO DATE</u>	<u>LAST 12 MONTHS</u>	<u>SINCE INCEPTION 6/03</u>
BEGINNING MARKET VALUE	12,598	11,461	11,145	9,055
NET EXTERNAL GROWTH	- 17	950	934	1,864
RETURN ON INVESTMENT	100	270	601	1,761
INCOME RECEIVED	197	570	876	1,629
GAIN/LOSS	- 98	- 300	- 275	133
ENDING MARKET VALUES	12,681	12,681	12,681	12,681

VERMONT MUNICIPAL EMPLOYEES
TOTAL FUND ASSET GROWTH SUMMARY (\$000)
PERIODS ENDING 9/05

ALTERNATIVE INVESTMENTS

	<u>LAST QUARTER</u>	<u>YEAR TO DATE</u>	<u>LAST 12 MONTHS</u>	<u>SINCE INCEPTION 6/00</u>
BEGINNING MARKET VALUE	632	740	831	1,036
NET EXTERNAL GROWTH	0	0	80	80
RETURN ON INVESTMENT	1	- 106	- 277	- 482
INCOME RECEIVED	1	3	3	67
GAIN/LOSS	0	- 109	- 280	- 550
ENDING MARKET VALUES	634	634	634	634

VERMONT MUNICIPAL EMPLOYEES
TOTAL FUND ASSET GROWTH SUMMARY (\$000)
PERIODS ENDING 9/05

VERMONT INVESTMENTS

	<u>LAST QUARTER</u>	<u>YEAR TO DATE</u>	<u>LAST 12 MONTHS</u>	<u>SINCE INCEPTION 3/01</u>
BEGINNING MARKET VALUE	438	645	926	526
NET EXTERNAL GROWTH	360	122	- 178	- 39
RETURN ON INVESTMENT	10	41	60	321
INCOME RECEIVED	20	- 448	64	401
GAIN/LOSS	- 10	489	- 5	- 80
ENDING MARKET VALUES	808	808	808	808

VERMONT MUNICIPAL EMPLOYEES

PORTFOLIO ASSET GROWTH SUMMARY (\$000)

QUARTER ENDING 9/05

PORTFOLIO	BEGINNING VALUE	NET CONTR	INCOME RECEIVED	GAIN (LOSS)	END VALUE
MUNI COMPOSITE	245,739	1,241	3,057	6,838	256,875
EQTY COMPOSITE	107,582	-51	1,925	3,867	113,323
DELAWARE	41,980	0	234	877	43,091
ALLIANCE	39,505	0	0	3,406	42,910
LAZARD	26,098	-51	1,690	-416	27,322
UBS	39,348	0	0	3,531	42,880
SSR TOWER FUND	17,668	-50	0	942	18,559
SEIX CORE	67,472	1,000	913	-1,394	67,991
SEIX HIGH YIELD	12,598	-17	197	-98	12,681
ALT. ASSETS	632	0	1	0	634
VERMONT INVEST	438	360	20	-10	808

YEAR TO DATE

PORTFOLIO	BEGINNING VALUE	NET CONTR	INCOME RECEIVED	GAIN (LOSS)	END VALUE
MUNI COMPOSITE	239,747	4,788	4,379	7,961	256,875
EQTY COMPOSITE	107,767	-143	2,384	3,315	113,323
DELAWARE	41,975	0	694	422	43,091
ALLIANCE	39,569	0	0	3,341	42,910
LAZARD	26,223	-143	1,690	-449	27,322
UBS	41,888	-2,000	-4	2,995	42,880
SSR TOWER FUND	14,404	1,859	0	2,296	18,559
SEIX CORE	62,842	4,000	1,873	-724	67,991
SEIX HIGH YIELD	11,461	950	570	-300	12,681
ALT. ASSETS	740	0	3	-109	634
VERMONT INVEST	645	122	-448	489	808

VERMONT MUNICIPAL EMPLOYEES

PORTFOLIO ASSET GROWTH SUMMARY (\$000)

YEAR ENDING 9/05

PORTFOLIO	BEGINNING VALUE	NET CONTR	INCOME RECEIVED	GAIN (LOSS)	END VALUE
MUNI COMPOSITE	221,740	6,965	9,857	18,313	256,875
EQTY COMPOSITE	96,296	1,812	6,721	8,495	113,323
DELAWARE	38,601	0	900	3,589	43,091
ALLIANCE	34,225	2,000	0	6,685	42,910
LAZARD	23,469	-188	5,820	-1,780	27,322
UBS	36,639	-2,000	-4	8,244	42,880
SSR TOWER FUND	14,106	1,817	0	2,636	18,559
SEIX CORE	61,797	4,500	2,196	-502	67,991
SEIX HIGH YIELD	11,145	934	876	-275	12,681
ALT. ASSETS	831	80	3	-280	634
VERMONT INVEST	926	-178	64	-5	808

VERMONT MUNICIPAL EMPLOYEES

ASSET ALLOCATION SUMMARY

AS OF 9/05

	MARKET VALUE (\$000)	COMMON STOCK	INT'L COMMON STOCK	BONDS	INT'L BONDS	CONV	CASH EQUIV	MORT	REAL ESTATE	SV ASSETS	PRVT INVEST	HEDGE FUNDS
** TOTAL FUND **												
MUNI COMPOSITE	256,875	44.1	16.7	31.5			0.3		7.2		0.2	
MEDIAN		46.5	11.7	27.5	0.0		1.7		0.0		0.0	0.0
** EQUITY MANAGERS **												
EQTY COMPOSITE	113,323	100.0					0.0					
DELAWARE	43,091	99.9					0.1					
ALLIANCE	42,910	100.0										
LAZARD	27,322	100.0										
MEDIAN		99.6										
** BOND MANAGERS **												
SEIX CORE	67,991			100.0								
SEIX HIGH YIELD	12,681			100.0								
MEDIAN				100.0								

VERMONT MUNICIPAL EMPLOYEES

ASSET ALLOCATION SUMMARY

AS OF 9/05

	MARKET VALUE (\$000)	COMMON STOCK	INT'L COMMON STOCK	BONDS	INT'L BONDS	CONV	CASH EQUIV	MORT	REAL ESTATE	SV ASSETS	PRVT INVEST	HEDGE FUNDS
** CASH EQUIV MANAGERS **												
VERMONT INVEST	808			36.1			63.9					
MEDIAN												
** INT'L DEVELOPED MKT EQUITY MANAGERS **												
UBS	42,880		100.0				0.0					
MEDIAN												
** REAL ESTATE MANAGERS **												
SSR TOWER FUND	18,559								100.0			
MEDIAN												
** PRIVATE EQUITY MANAGERS **												
ALT. ASSETS	634						25.5				74.5	
MEDIAN												

VERMONT MUNICIPAL EMPLOYEES
ASSET ALLOCATION ANALYSIS
AS OF SEPTEMBER 30, 2005

DELAWARE

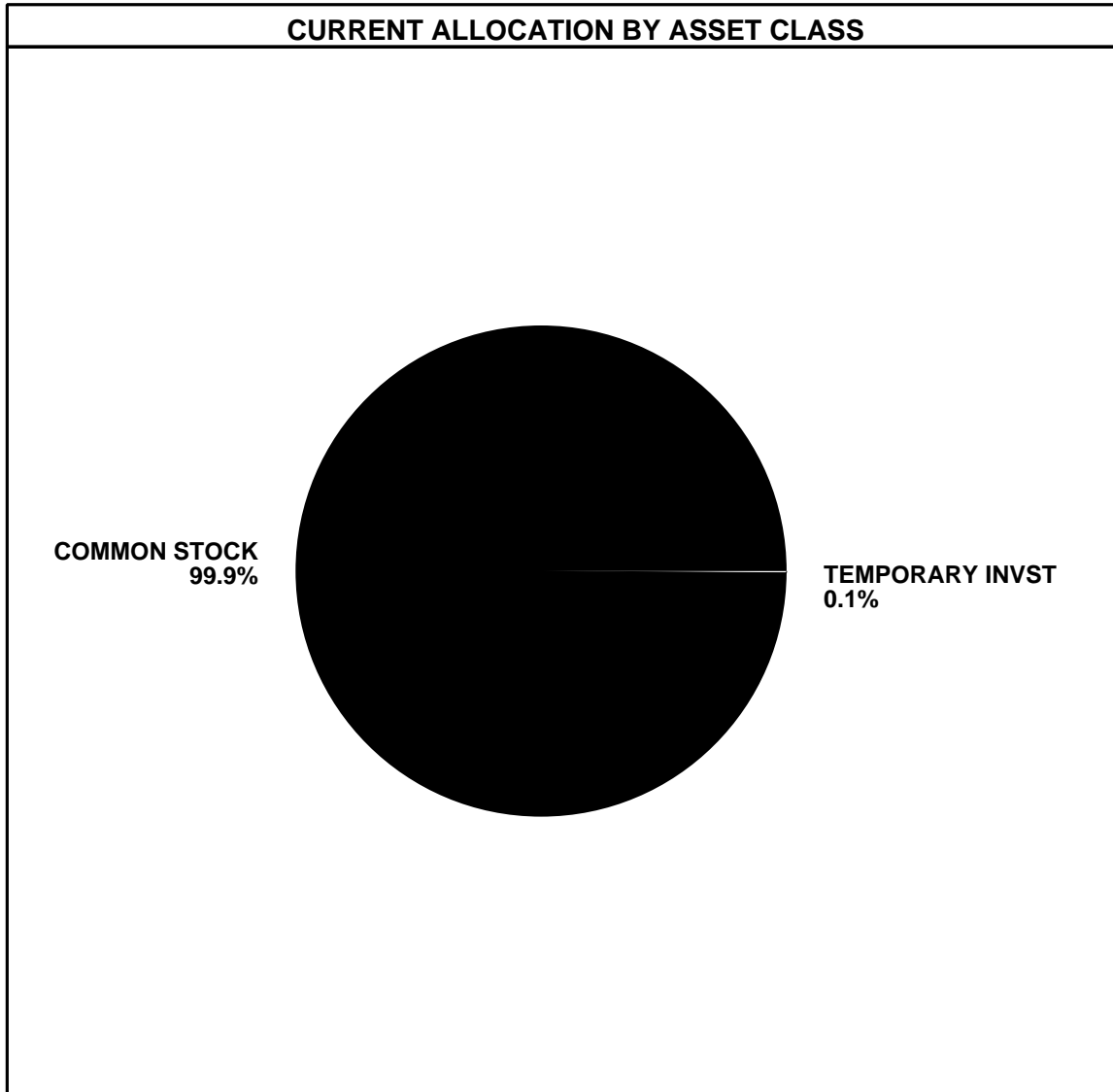

<u>ASSET CLASS</u>	<u>CURRENT DOLLARS</u>	<u>CURRENT %</u>
COMMON STOCK	43,049,486	99.9
TEMPORARY INVST	<u>41,691</u>	<u>0.1</u>
TOTAL	43,091,177	100.0

VERMONT MUNICIPAL EMPLOYEES
ASSET ALLOCATION ANALYSIS
AS OF SEPTEMBER 30, 2005

ALLIANCE LARGE CAP GROWTH FUND

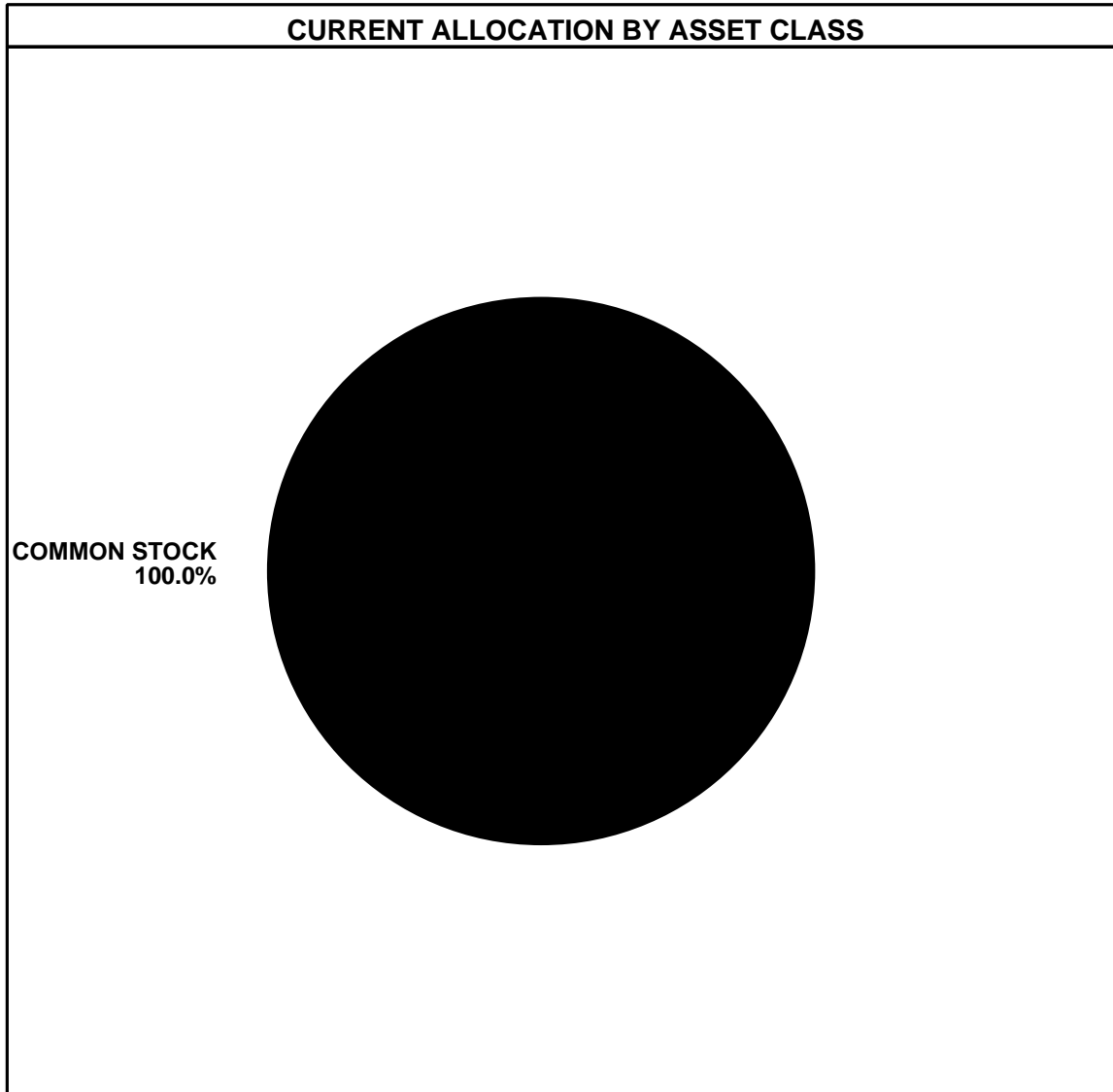

<u>ASSET CLASS</u>	<u>CURRENT DOLLARS</u>	<u>CURRENT %</u>
COMMON STOCK	<u>42,910,388</u>	<u>100.0</u>
TOTAL	42,910,388	100.0

VERMONT MUNICIPAL EMPLOYEES
ASSET ALLOCATION ANALYSIS
AS OF SEPTEMBER 30, 2005

LAZARD SMALL CAP FUND

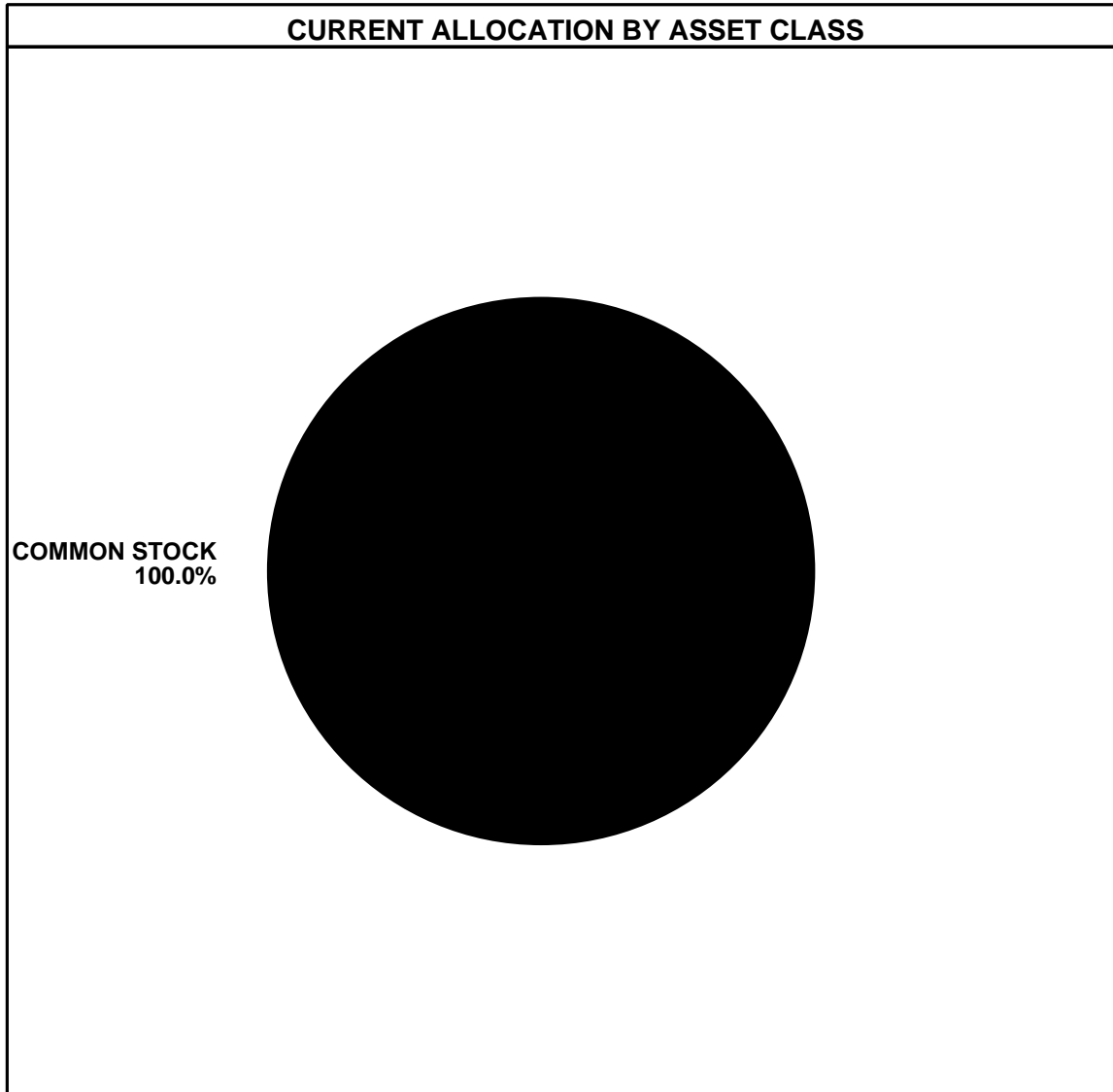

<u>ASSET CLASS</u>	<u>CURRENT DOLLARS</u>	<u>CURRENT %</u>
COMMON STOCK	<u>27,321,546</u>	<u>100.0</u>
TOTAL	27,321,546	100.0

VERMONT MUNICIPAL EMPLOYEES
ASSET ALLOCATION ANALYSIS
AS OF SEPTEMBER 30, 2005

BRINSON - UBS

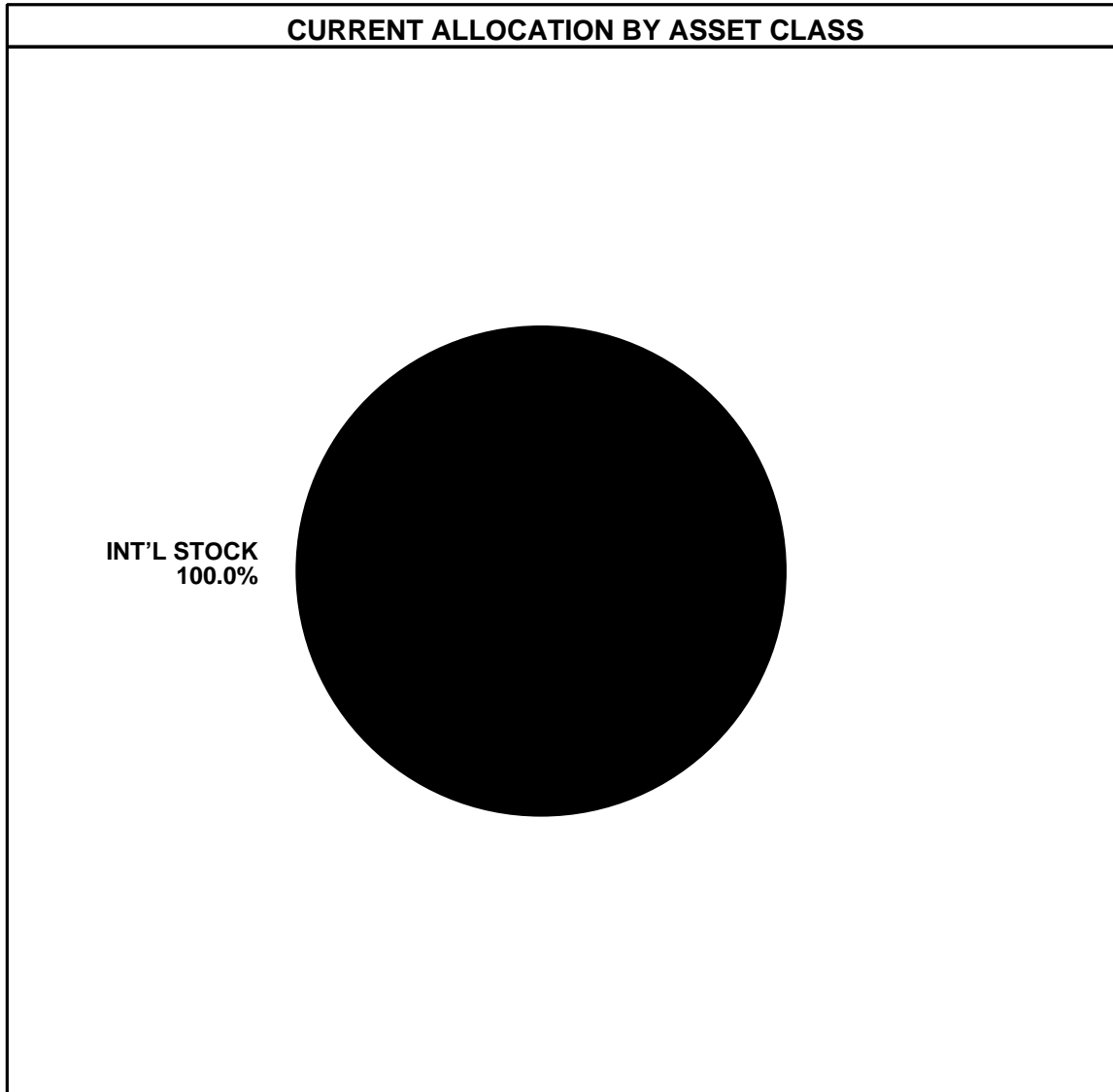

<u>ASSET CLASS</u>	<u>CURRENT DOLLARS</u>	<u>CURRENT %</u>
INT'L STOCK	42,871,400	100.0
TEMPORARY INVST	<u>8,141</u>	<u>0.0</u>
TOTAL	42,879,541	100.0

VERMONT MUNICIPAL EMPLOYEES
ASSET ALLOCATION ANALYSIS
AS OF SEPTEMBER 30, 2005

SEIX CORE

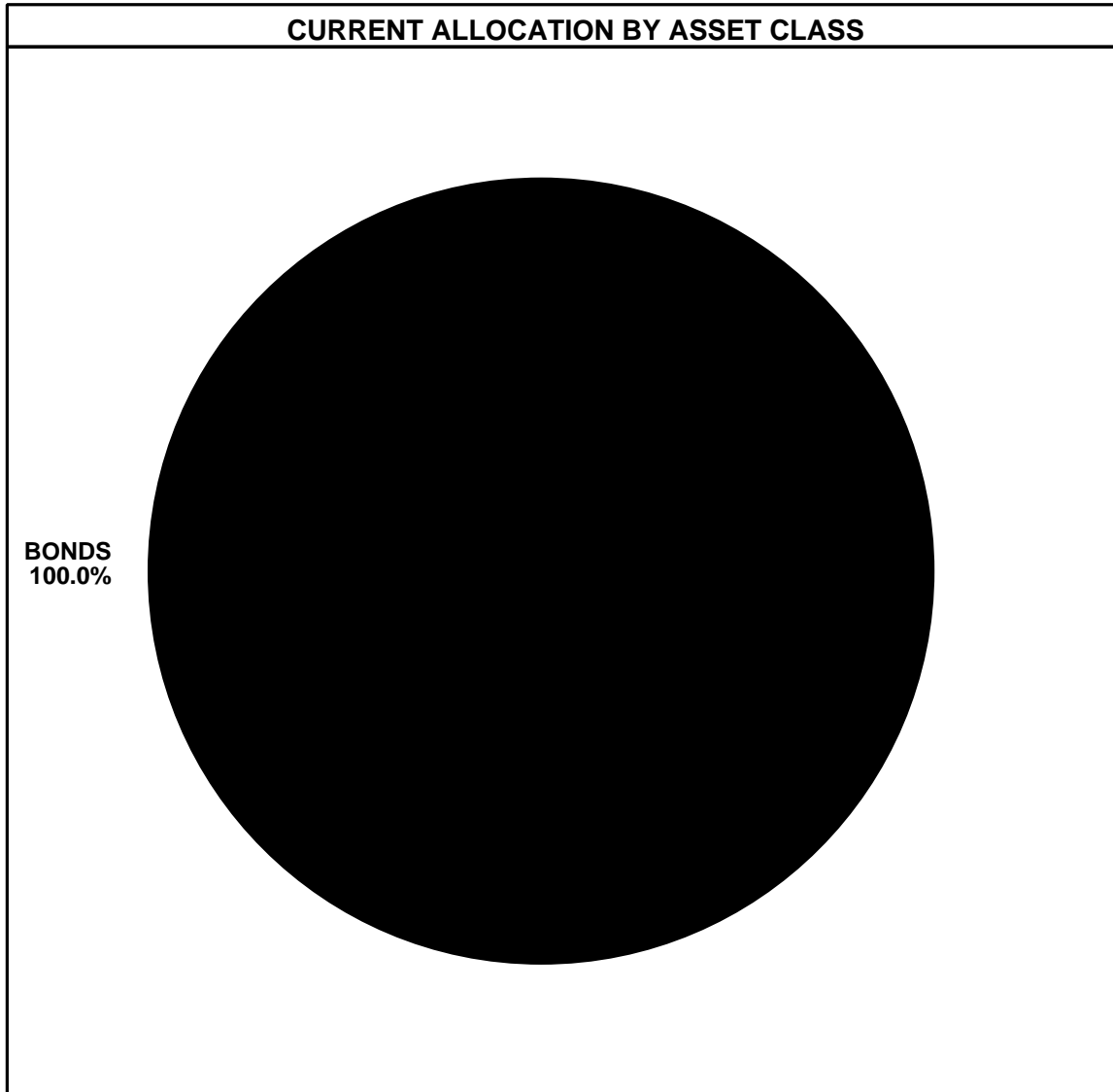

<u>ASSET CLASS</u>	<u>CURRENT DOLLARS</u>	<u>CURRENT %</u>
BONDS	<u>67,991,211</u>	<u>100.0</u>
TOTAL	67,991,211	100.0

VERMONT MUNICIPAL EMPLOYEES
ASSET ALLOCATION ANALYSIS
AS OF SEPTEMBER 30, 2005

SEIX HIGH YIELD

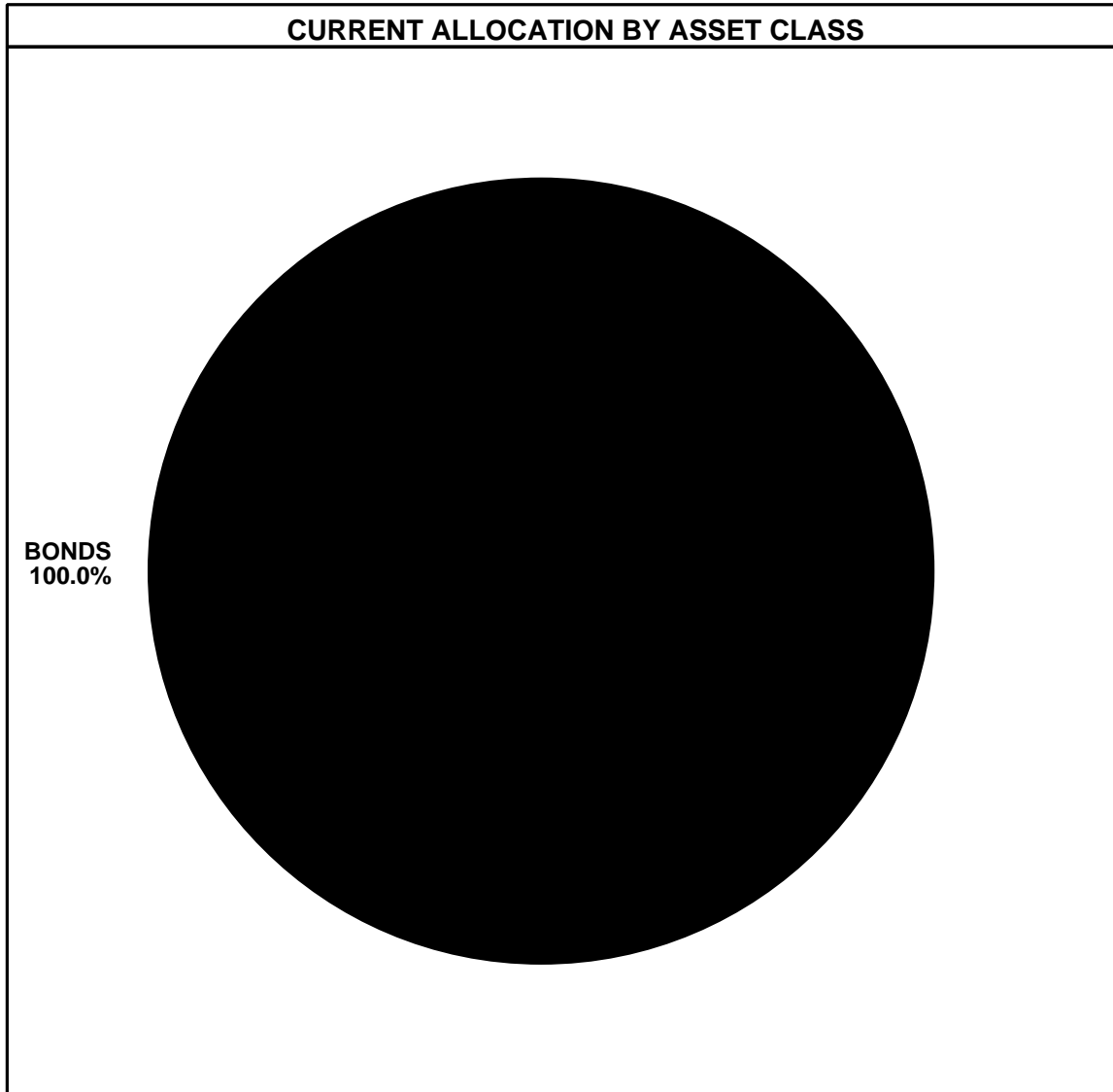

<u>ASSET CLASS</u>	<u>CURRENT DOLLARS</u>	<u>CURRENT %</u>
BONDS	<u>12,680,552</u>	<u>100.0</u>
TOTAL	12,680,552	100.0

VERMONT MUNICIPAL EMPLOYEES
ASSET ALLOCATION ANALYSIS
AS OF SEPTEMBER 30, 2005

MUNICIPAL SYSTEM COMPOSITE

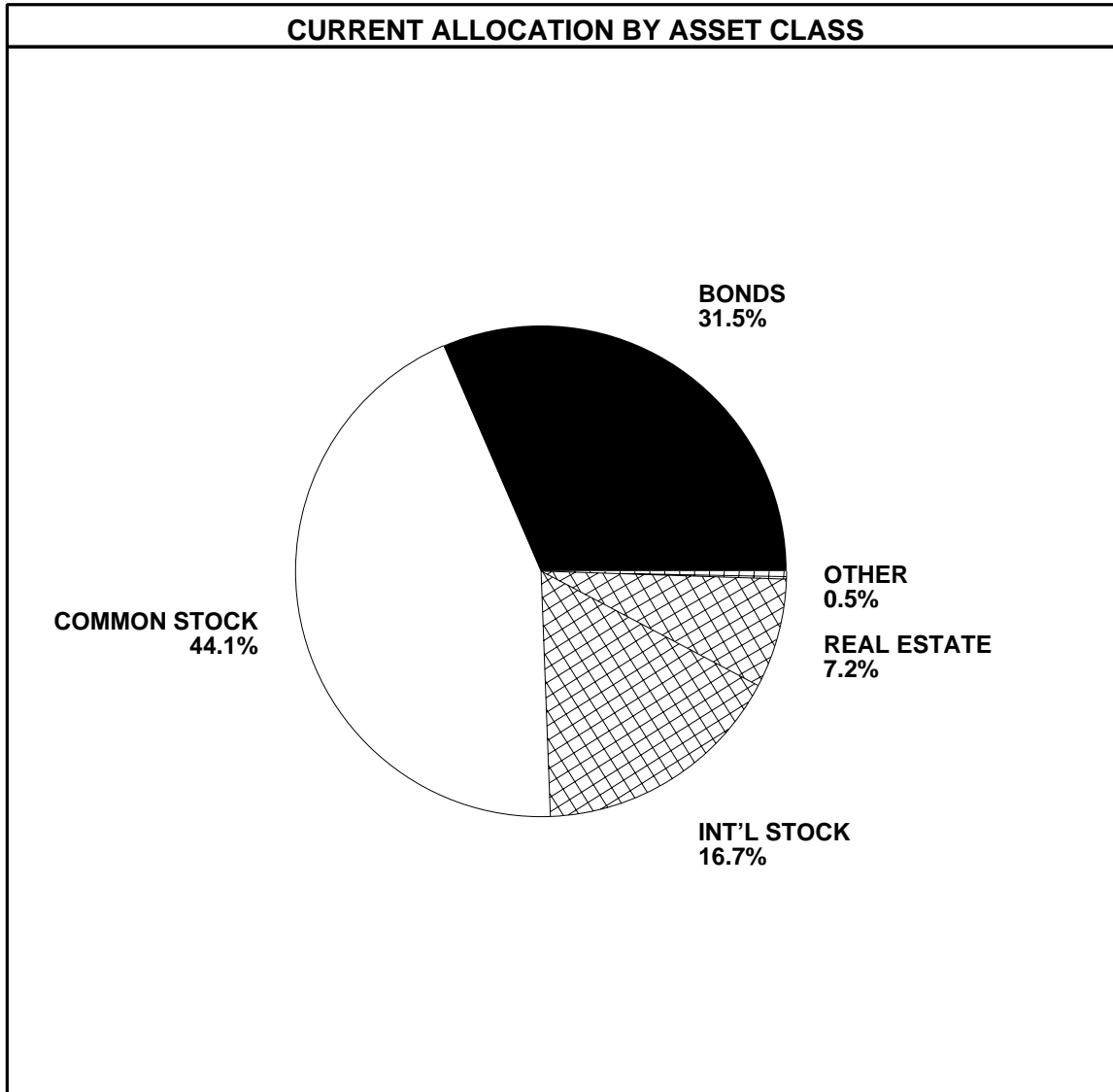

<u>ASSET CLASS</u>	<u>CURRENT DOLLARS</u>	<u>CURRENT %</u>
COMMON STOCK	113,281,420	44.1
INT'L STOCK	42,871,400	16.7
TEMPORARY INVST	727,575	0.3
BONDS	80,963,796	31.5
REAL ESTATE	18,558,732	7.2
PRIVATE INVEST	472,146	0.2
TOTAL	256,875,069	100.0

VERMONT MUNICIPAL EMPLOYEES

ASSET ALLOCATION ANALYSIS

AS OF SEPTEMBER 30, 2005

DOMESTIC EQUITY COMPOSITE

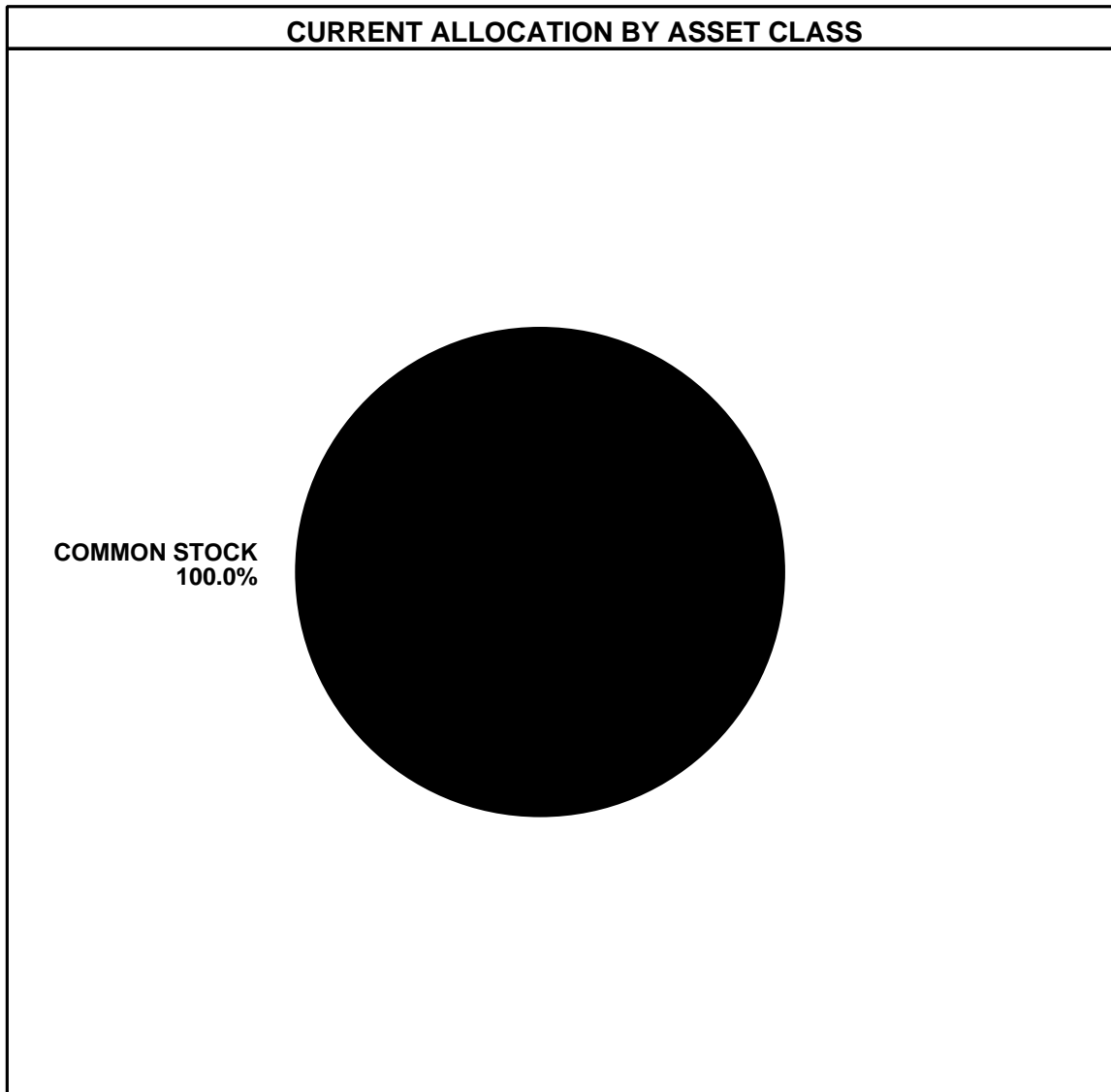

<u>ASSET CLASS</u>	<u>CURRENT DOLLARS</u>	<u>CURRENT %</u>
COMMON STOCK	113,281,420	100.0
TEMPORARY INVST	<u>41,691</u>	<u>0.0</u>
TOTAL	113,323,111	100.0

VERMONT MUNICIPAL EMPLOYEES
ALLOCATION BY MANAGER TYPE ANALYSIS
AS OF SEPTEMBER 30, 2005

MUNICIPAL SYSTEM COMPOSITE

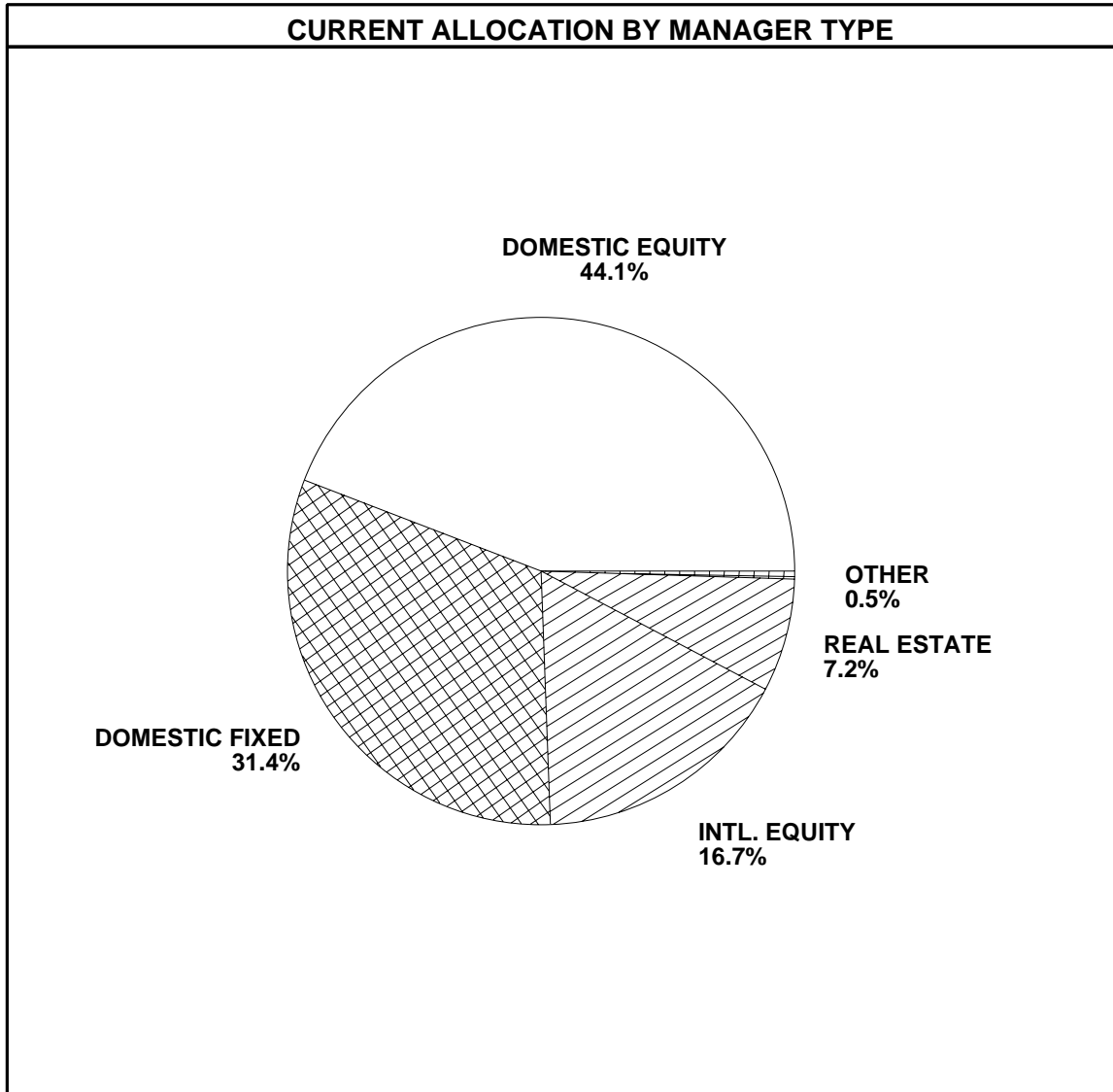

<u>MANAGER TYPE</u>	<u>CURRENT DOLLARS</u>	<u>CURRENT %</u>
CASH	808,143	0.3
DOMESTIC EQUITY	113,323,111	44.1
INTL. EQUITY	42,879,541	16.7
DOMESTIC FIXED	80,671,763	31.4
REAL ESTATE	18,558,732	7.2
PRIVATE EQUITY	<u>633,779</u>	<u>0.2</u>
TOTAL	256,875,069	100.0

**VERMONT MUNICIPAL EMPLOYEES
MANAGER ALLOCATION ANALYSIS
AS OF SEPTEMBER 30, 2005**

MUNICIPAL SYSTEM COMPOSITE

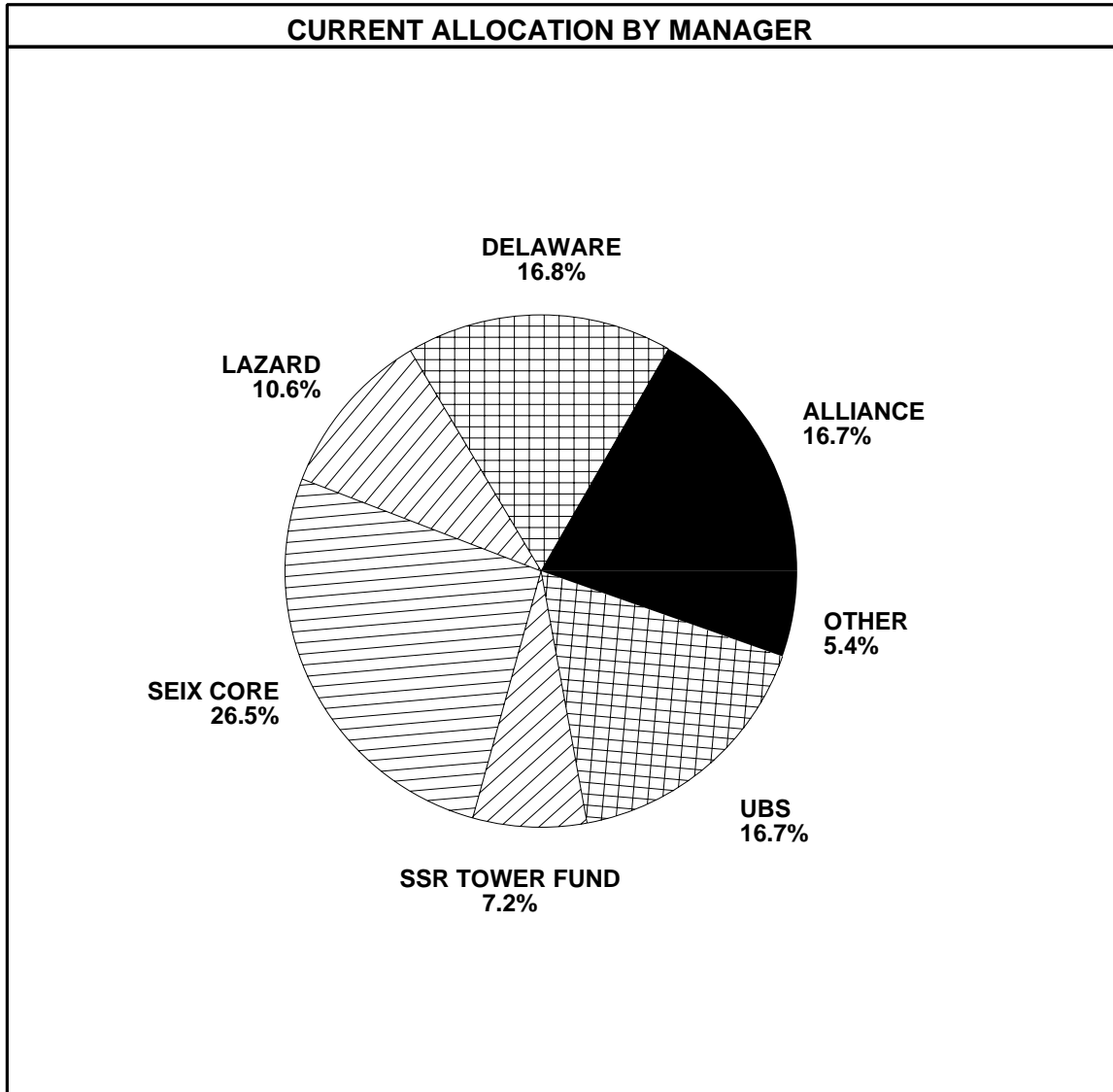

<u>MANAGER</u>	<u>CURRENT DOLLARS</u>	<u>CURRENT %</u>
ALLIANCE	0	0.0
ALLIANCE	42,910,388	16.7
ALT. ASSETS	633,779	0.2
DELAWARE	43,091,177	16.8
LAZARD	27,321,546	10.6
LOOMIS	0	0.0
SEIX CORE	67,991,211	26.5
SEIX HIGH YIELD	12,680,552	4.9
SSR TOWER FUND	18,558,732	7.2
UBS	42,879,541	16.7
VERMONT INVEST	<u>808,143</u>	<u>0.3</u>
TOTAL	256,875,069	100.0

**VERMONT MUNICIPAL EMPLOYEES
MANAGER ALLOCATION ANALYSIS
AS OF SEPTEMBER 30, 2005**

DOMESTIC EQUITY COMPOSITE

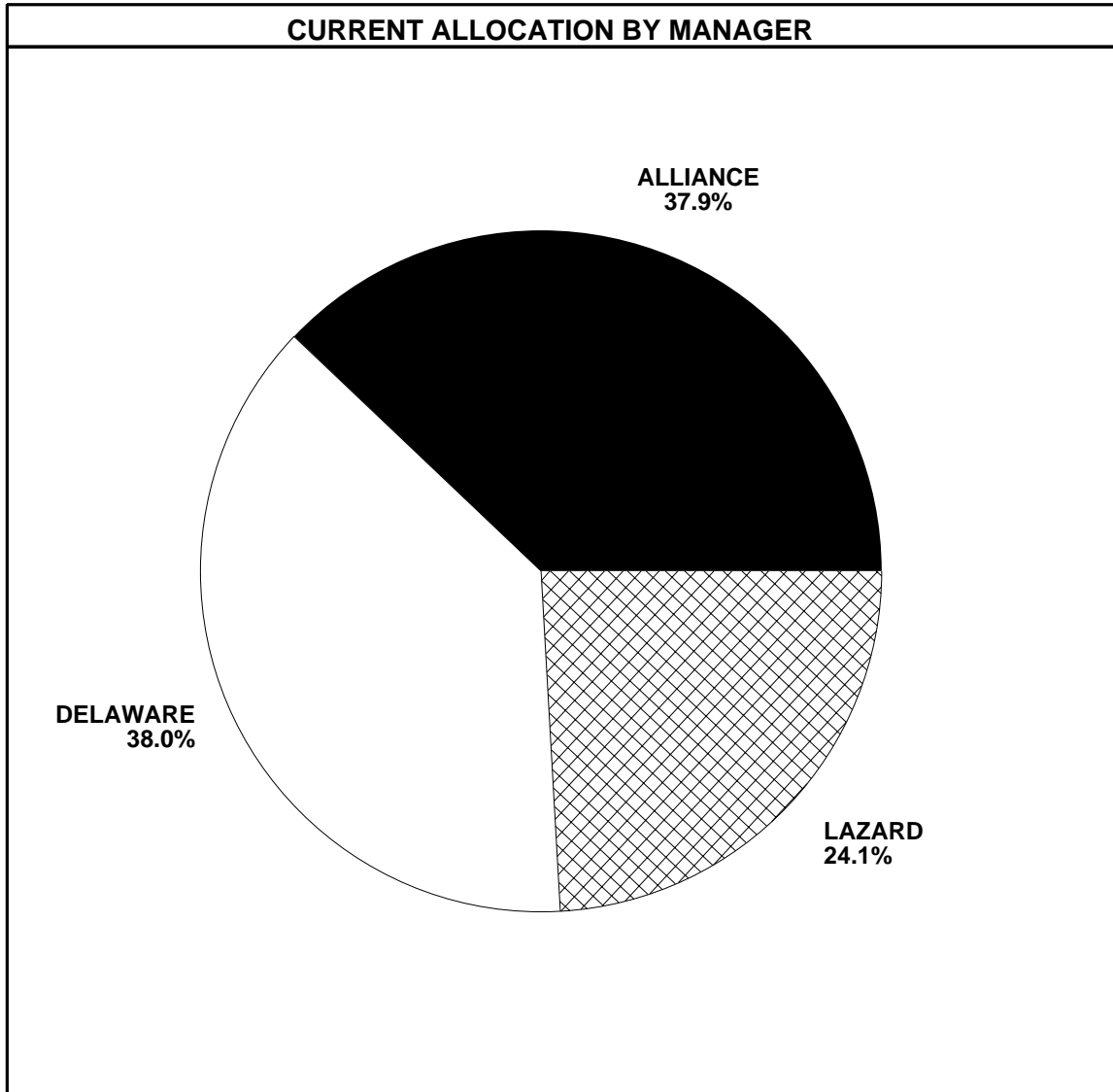

MANAGER	CURRENT DOLLARS	CURRENT %
ALLIANCE	42,910,388	37.9
DELAWARE	43,091,177	38.0
LAZARD	27,321,546	24.1
TOTAL	113,323,111	100.0

VERMONT MUNICIPAL EMPLOYEES

TOTAL FUNDS - EQUITY COMMITMENT

ASSET ALLOCATION HISTORY

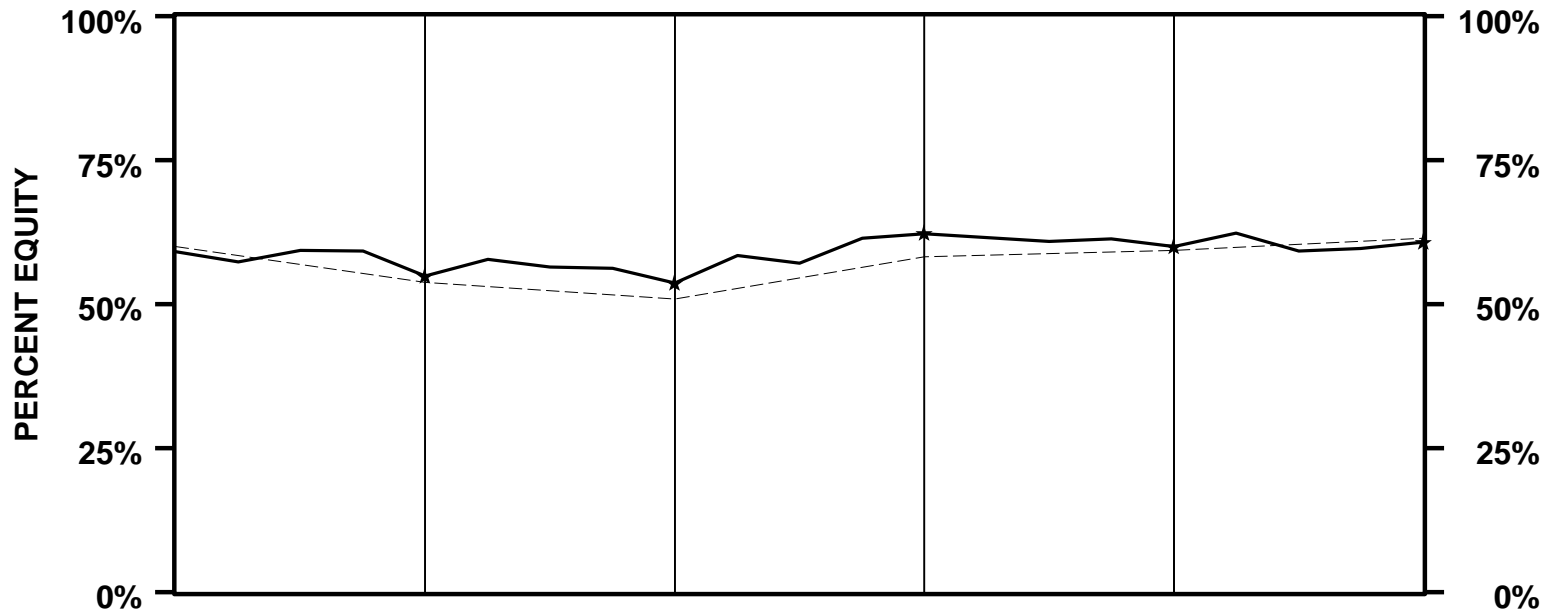

	9/00	9/01	9/02	9/03	9/04	9/05
HIGH	85.7	80.8	79.4	81.0	79.8	81.1
1ST QTL	67.6	61.6	59.4	65.7	66.2	68.1
■ MEDIAN	60.0	53.8	50.9	58.2	59.4	61.5
3RD QTL	47.6	40.9	37.3	47.1	49.4	50.4
LOW	0.0	0.0	0.0	0.0	0.0	0.0
★ MUNI COMPOSITE	59.1	54.9	53.7	62.3	60.0	60.8
	53	46	41	34	47	53

* Includes International Segment

VERMONT MUNICIPAL EMPLOYEES

TOTAL FUNDS - BOND COMMITMENT

ASSET ALLOCATION HISTORY

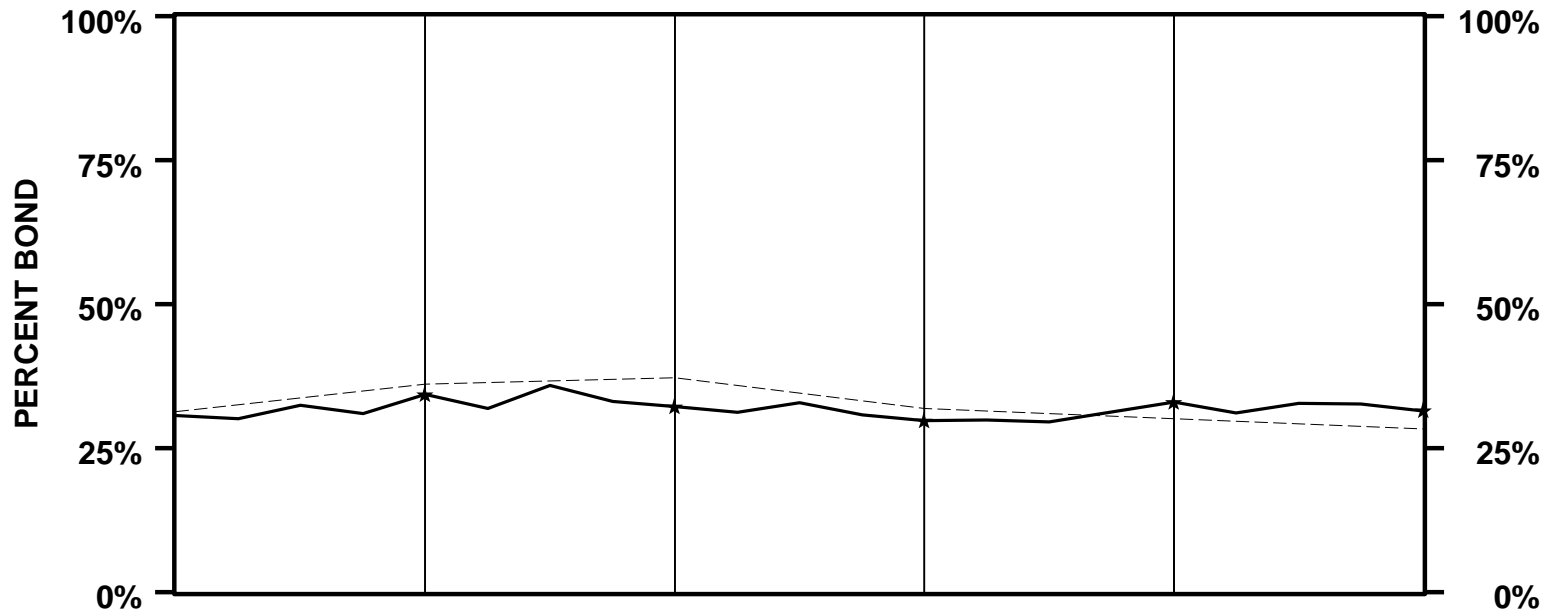

	9/00		9/01		9/02		9/03		9/04		9/05	
HIGH	77.8		75.4		77.2		74.8		74.2		73.9	
1ST QTL	39.8		44.1		46.3		40.8		38.8		36.6	
— MEDIAN	31.3		36.1		37.2		31.9		30.1		28.3	
3RD QTL	20.8		24.5		24.9		23.3		21.0		19.2	
LOW	0.0		0.0		0.0		0.0		0.0		0.0	
★ MUNI COMPOSITE	30.7	51	34.3	54	32.2	63	29.8	56	33.0	40	31.5	39

* Includes International Segment

VERMONT MUNICIPAL EMPLOYEES

EQUITY FUNDS - EQUITY COMMITMENT

ASSET ALLOCATION HISTORY

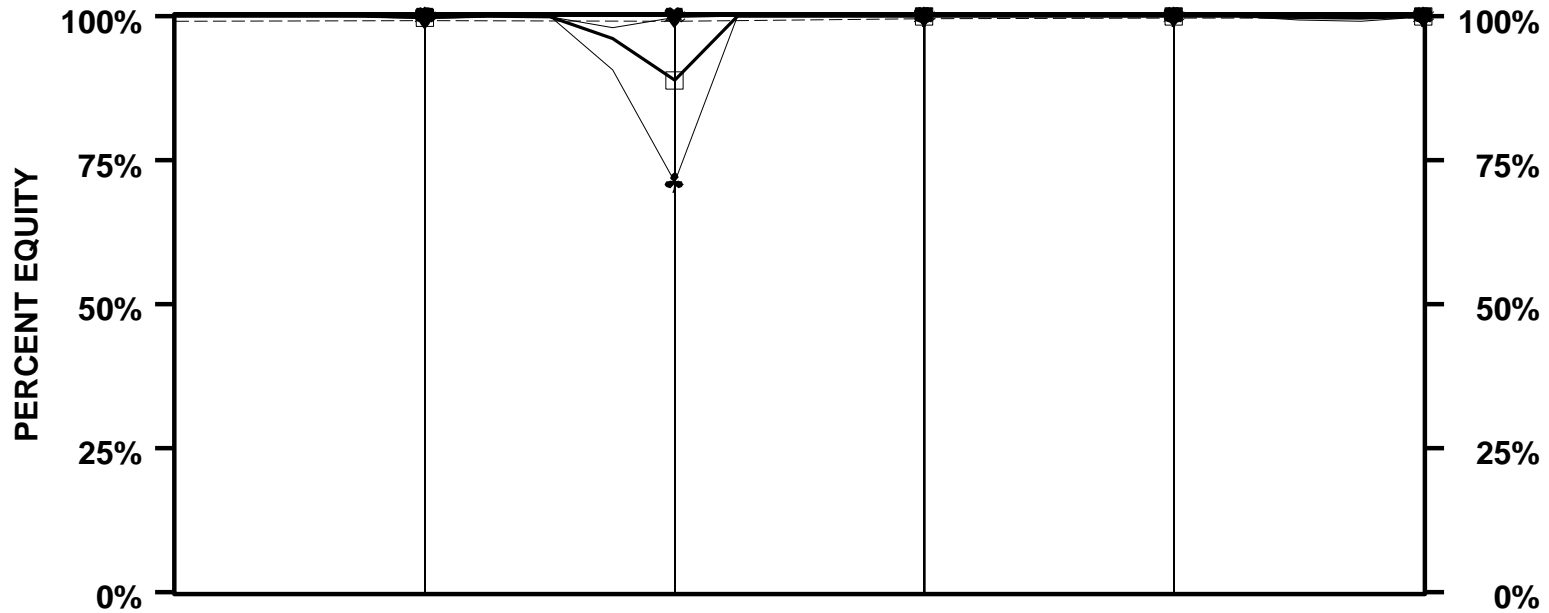

	9/00	9/01	9/02	9/03	9/04	9/05
HIGH	100.0	100.0	100.0	100.0	100.0	100.0
1ST QTL	100.0	100.0	100.0	100.0	100.0	100.0
■ MEDIAN	99.2	99.3	99.2	99.6	99.7	99.7
3RD QTL	95.7	95.5	95.5	96.6	96.9	96.8
LOW	0.0	29.3	0.1	50.9	51.4	51.1
□ EQTY COMPOSITE	100.0	99.8	88.9	100.0	100.0	100.0
♥ DELAWARE	100.0	99.6	99.8	100.0	100.0	99.9
♣ ALLIANCE	100.0	100.0	71.2	100.0	100.0	100.0
⌘ LAZARD	100.0	100.0	100.0	100.0	100.0	100.0
♥ UBS	100.0	100.0	100.0	100.0	100.0	100.0

* Includes International Segment

VERMONT MUNICIPAL EMPLOYEES

BOND FUNDS - BOND COMMITMENT

ASSET ALLOCATION HISTORY

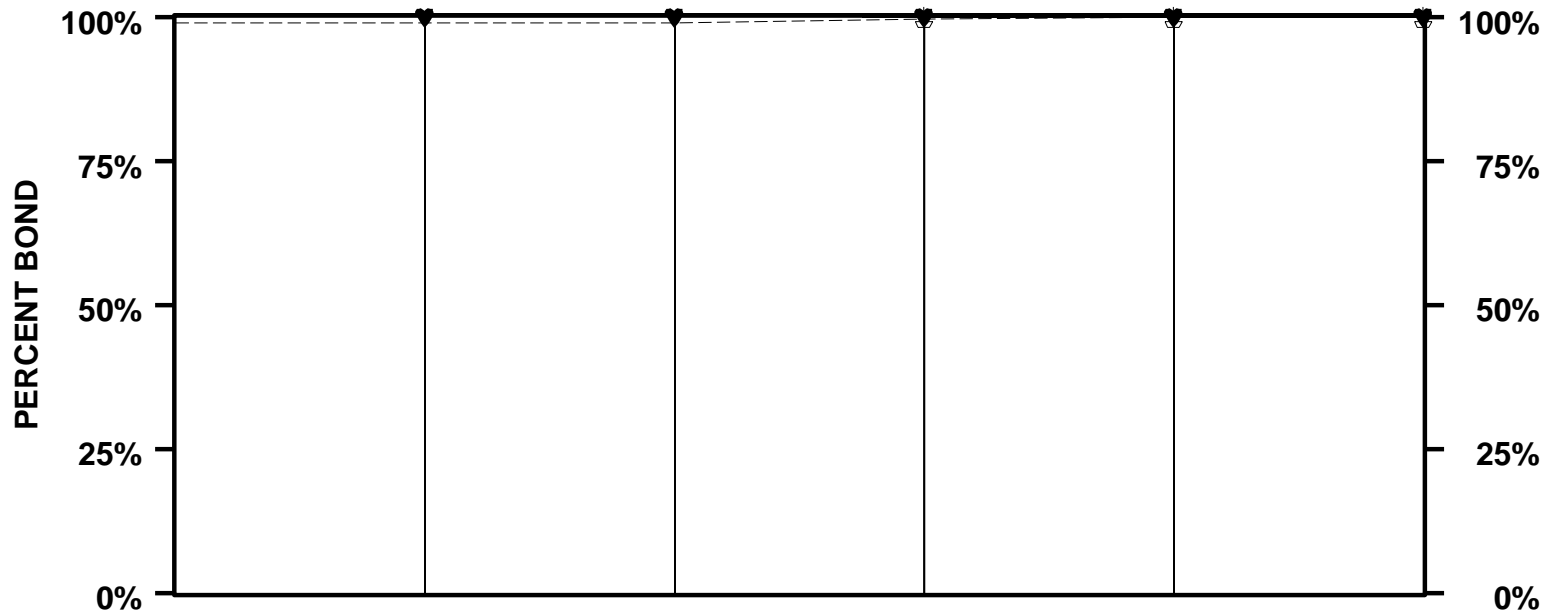

	9/00	9/01	9/02	9/03	9/04	9/05
HIGH	100.0	100.0	100.0	100.0	100.0	100.0
1ST QTL	100.0	100.0	100.0	100.0	100.0	100.0
■ MEDIAN	99.0	99.0	99.0	99.7	100.0	100.0
3RD QTL	94.3	92.8	91.9	94.2	95.4	96.6
LOW	0.0	0.0	0.0	0.0	0.0	0.0
♥ SEIX CORE	100.0	1	100.0	1	100.0	1
⚡ SEIX HIGH YIELD				100.0	1	100.0

* Includes International Segment

VERMONT MUNICIPAL EMPLOYEES

PERFORMANCE SUMMARY

PERIODS ENDING 9/05

	<u>LAST QTR</u>		<u>LAST 2 QTRS</u>		<u>LAST 3 QTRS</u>		<u>LAST YEAR</u>		<u>LAST 3 YEARS</u>		<u>LAST 5 YEARS</u>	
** TOTAL FUND **												
MUNI COMPOSITE	4.0	40	6.5	34	5.0	44	12.5	55	13.4	60	5.3	33
ALLOC INDEX	3.6	51	6.0	48	4.7	51	13.1	45	14.6	39	3.7	66
POLICY INDEX	3.7	49	6.0	46	4.9	47	12.8	48	14.8	36	4.2	56
MEDIAN	3.7		5.9		4.8		12.8		14.1		4.4	
** EQUITY MANAGERS **												
EQTY COMPOSITE	5.4	34	8.9	32	5.4	46	15.6	57	17.0	70	2.7	51
DELAWARE	2.6	85	4.0	88	2.7	79	11.6	86	17.0	70	6.1	39
ALLIANCE	8.6	6	15.6	2	8.4	19	18.5	39	14.0	90	-5.7	92
LAZARD	4.9	42	7.0	50	5.0	50	17.5	46	21.5	38	12.2	19
S&P 500	3.6	70	5.0	77	2.8	77	12.3	80	16.7	78	-1.5	77
R 1000(R) GR	4.0	57	6.6	54	2.2	84	11.6	86	14.7	88	-8.6	97
R 1000(R) VALUE	3.9	60	5.6	67	5.7	42	16.7	50	20.5	46	5.8	41
R 2000(R)	4.7	46	9.2	30	3.4	66	18.0	43	24.1	20	6.4	38
MEDIAN	4.4		7.1		5.0		16.8		20.1		3.1	

VERMONT MUNICIPAL EMPLOYEES

PERFORMANCE SUMMARY

PERIODS ENDING 9/05

	<u>LAST QTR</u>		<u>LAST 2 QTRS</u>		<u>LAST 3 QTRS</u>		<u>LAST YEAR</u>		<u>LAST 3 YEARS</u>		<u>LAST 5 YEARS</u>	
** BOND MANAGERS **												
SEIX CORE	- 0.7	89	2.0	77	1.7	72	2.6	73	4.7	49	6.3	70
SEIX HIGH YIELD	0.8	14	3.6	8	2.1	51	5.1	15				
LB AGGREGATE	- 0.7	85	2.3	58	1.8	65	2.8	67	4.0	66	6.6	62
ML HIGH YLD II	0.9	10	3.6	10	2.1	50	6.7	6	15.7	1	7.2	39
MEDIAN	- 0.3		2.4		2.1		3.3		4.7		6.9	
** CASH EQUIV MANAGERS **												
VERMONT INVEST	1.0	13	1.5	65	3.3	7	4.4	8	2.3	16	3.5	13
90 DAY T-BILLS	0.8	46	1.6	45	2.1	45	2.6	38	1.7	46	2.5	54
MEDIAN	0.8		1.5		2.1		2.6		1.7		2.5	
** INT'L DEVELOPED MKT EQUITY MANAGERS **												
UBS	9.0	77	7.9	77	7.5	79	22.9	78	23.5	68	6.4	49
MS EAFE NET	10.4	56	9.3	61	9.1	66	25.8	59	24.6	61	3.2	78
CITI PMI EPAC	11.0	47	10.3	46	10.2	53	27.3	42	25.1	52	3.5	74
MEDIAN	10.8		9.9		10.6		26.4		25.3		6.2	

VERMONT MUNICIPAL EMPLOYEES

PERFORMANCE SUMMARY

PERIODS ENDING 9/05

	<u>LAST QTR</u>		<u>LAST 2 QTRS</u>		<u>LAST 3 QTRS</u>		<u>LAST YEAR</u>		<u>LAST 3 YEARS</u>		<u>LAST 5 YEARS</u>	
** REAL ESTATE MANAGERS **												
SSR TOWER FUND	5.3	17	9.8	41	14.6	31	17.4	52	9.6	67	7.9	66
NCREIF PROPERTY	4.4	31	10.0	39	13.9	34	19.2	45	13.0	46	11.0	41
MEDIAN	3.4		8.7		11.6		18.5		12.6		10.3	
** PRIVATE EQUITY MANAGERS **												
ALT. ASSETS	0.2	45	-14.4	93	-14.4	92	-30.4	95	-13.3	88	-11.0	77
MEDIAN	0.0		1.1		4.7		7.9		5.0		-1.1	

VERMONT MUNICIPAL EMPLOYEES

PERFORMANCE SUMMARY NET OF FEES

PERIODS ENDING 9/05

	LAST QTR	LAST 2 QTRS	LAST 3 QTRS	LAST YEAR	LAST 3 YEARS	LAST 5 YEARS
** TOTAL FUND **						
MUNI COMPOSITE	4.0	6.4	4.9	12.3	13.2	
ALLOC INDEX	3.6	6.0	4.7	13.1	14.6	3.7
POLICY INDEX	3.7	6.0	4.9	12.8	14.8	4.2
** EQUITY MANAGERS **						
EQTY COMPOSITE	5.3	8.8	5.2	15.3	16.7	
DELAWARE	2.6	4.0	2.7	11.6	17.0	
ALLIANCE	8.6	15.6	8.4	18.5	14.0	
LAZARD	4.7	6.6	4.4	16.7	20.6	
S&P 500	3.6	5.0	2.8	12.3	16.7	- 1.5
R 1000(R) GR	4.0	6.6	2.2	11.6	14.7	- 8.6
R 1000(R) VALUE	3.9	5.6	5.7	16.7	20.5	5.8
R 2000(R)	4.7	9.2	3.4	18.0	24.1	6.4
** BOND MANAGERS **						
SEIX CORE	- 0.7	2.0	1.7	2.6	4.7	
SEIX HIGH YIELD	0.7	3.4	1.6	4.5		
LB AGGREGATE	- 0.7	2.3	1.8	2.8	4.0	6.6
ML HIGH YLD II	0.9	3.6	2.1	6.7	15.7	7.2
** CASH EQUIV MANAGERS **						
VERMONT INVEST	1.0	1.5	3.3	4.4	2.3	

VERMONT MUNICIPAL EMPLOYEES

PERFORMANCE SUMMARY NET OF FEES

PERIODS ENDING 9/05

	<u>LAST QTR</u>	<u>LAST 2 QTRS</u>	<u>LAST 3 QTRS</u>	<u>LAST YEAR</u>	<u>LAST 3 YEARS</u>	<u>LAST 5 YEARS</u>
** CASH EQUIV MANAGERS **						
<i>90 DAY T-BILLS</i>	0.8	1.6	2.1	2.6	1.7	2.5
** INT'L DEVELOPED MKT EQUITY MANAGERS **						
UBS	9.0	7.9	7.5	22.9	23.5	
<i>MS EAFE NET</i>	10.4	9.3	9.1	25.8	24.6	3.2
<i>CITI PMI EPAC</i>	11.0	10.3	10.2	27.3	25.1	3.5
** REAL ESTATE MANAGERS **						
SSR TOWER FUND	5.0	9.1	13.6	16.1	8.5	
<i>NCREIF PROPERTY</i>	4.4	10.0	13.9	19.2	13.0	11.0
** PRIVATE EQUITY MANAGERS **						
ALT. ASSETS	0.2	- 14.4	- 14.4	- 30.4	- 13.3	

VERMONT MUNICIPAL EMPLOYEES

TOTAL FUNDS - TOTAL RATES OF RETURN

PERIODS ENDING 9/05

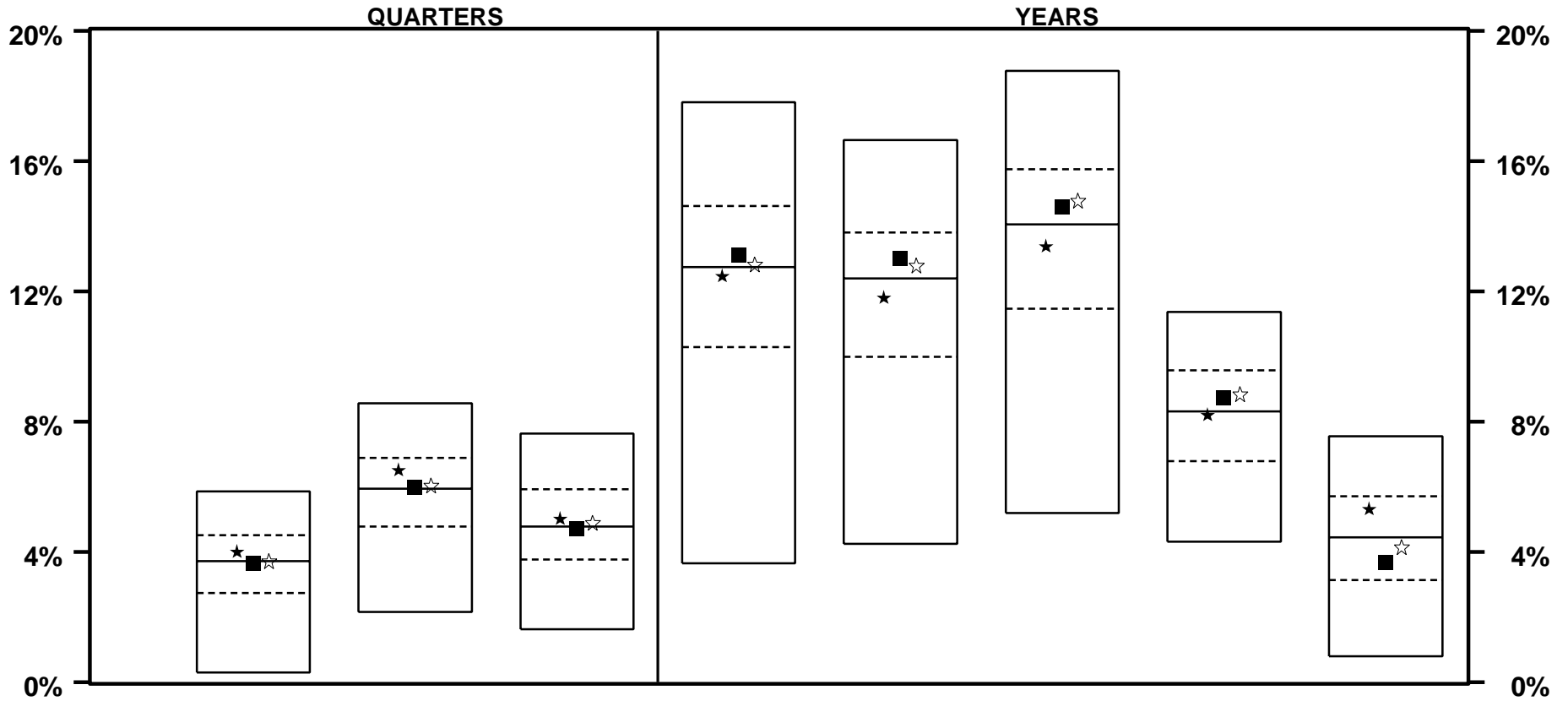

	LAST QTR		LAST 2 QTRS		LAST 3 QTRS		LAST YEAR		LAST 2 YEARS		LAST 3 YEARS		LAST 4 YEARS		LAST 5 YEARS	
★ MUNI COMPOSITE	4.0	40	6.5	34	5.0	44	12.5	55	11.8	58	13.4	60	8.2	52	5.3	33
■ ALLOC INDEX	3.6	51	6.0	48	4.7	51	13.1	45	13.0	37	14.6	39	8.7	42	3.7	66
☆ POLICY INDEX	3.7	49	6.0	46	4.9	47	12.8	48	12.8	42	14.8	36	8.9	39	4.2	56
MEDIAN	3.7		5.9		4.8		12.8		12.4		14.1		8.3		4.4	

VERMONT MUNICIPAL EMPLOYEES

TOTAL FUNDS - TOTAL RATES OF RETURN

PERIODS ENDING 9/05

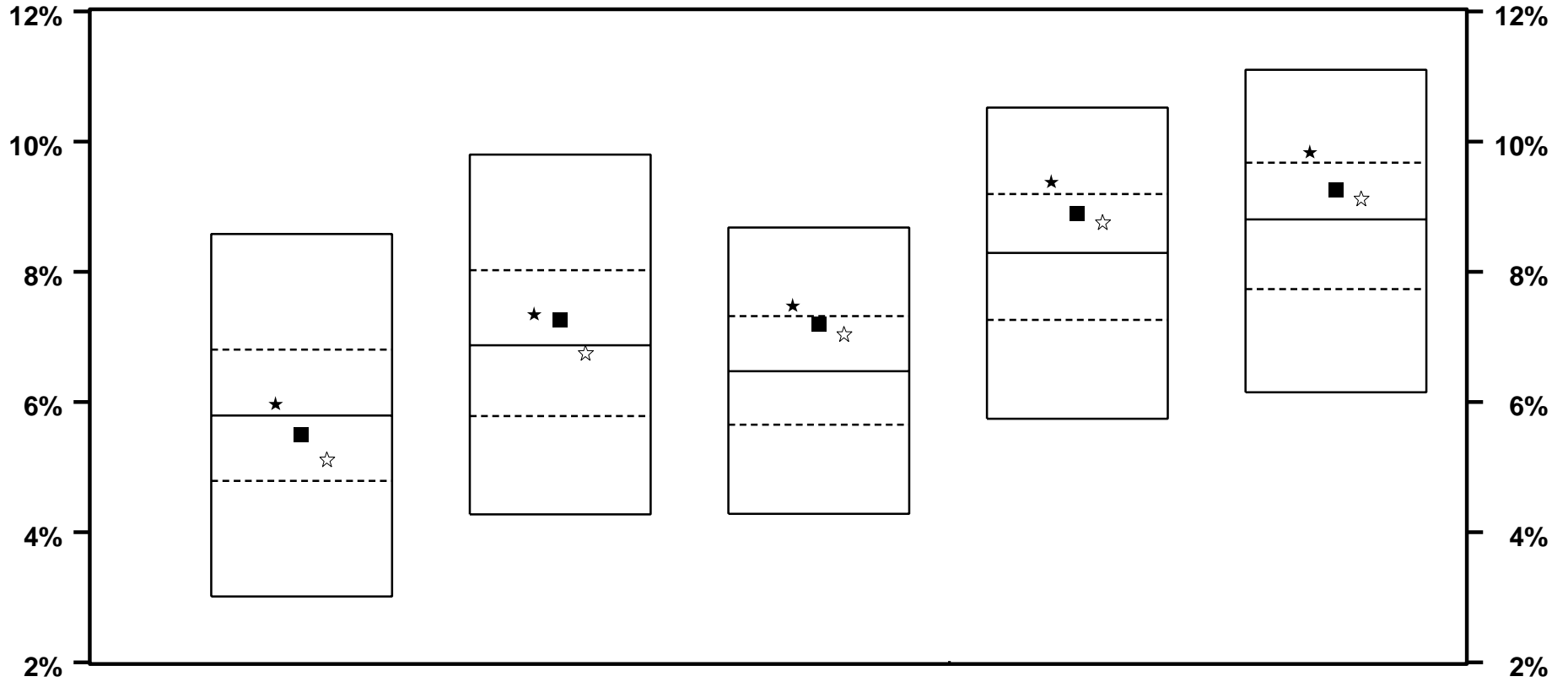

	LAST 6 YEARS		LAST 7 YEARS		LAST 8 YEARS		LAST 9 YEARS		LAST 10 YEARS	
★ MUNI COMPOSITE	6.0	45	7.4	39	7.5	20	9.4	20	9.8	20
■ ALLOC INDEX	5.5	58	7.3	41	7.2	27	8.9	33	9.3	36
☆ POLICY INDEX	5.1	67	6.8	53	7.1	30	8.8	36	9.1	38
MEDIAN	5.8		6.9		6.5		8.3		8.8	

VERMONT MUNICIPAL EMPLOYEES

TOTAL FUNDS - TOTAL RATES OF RETURN

YEARS ENDING

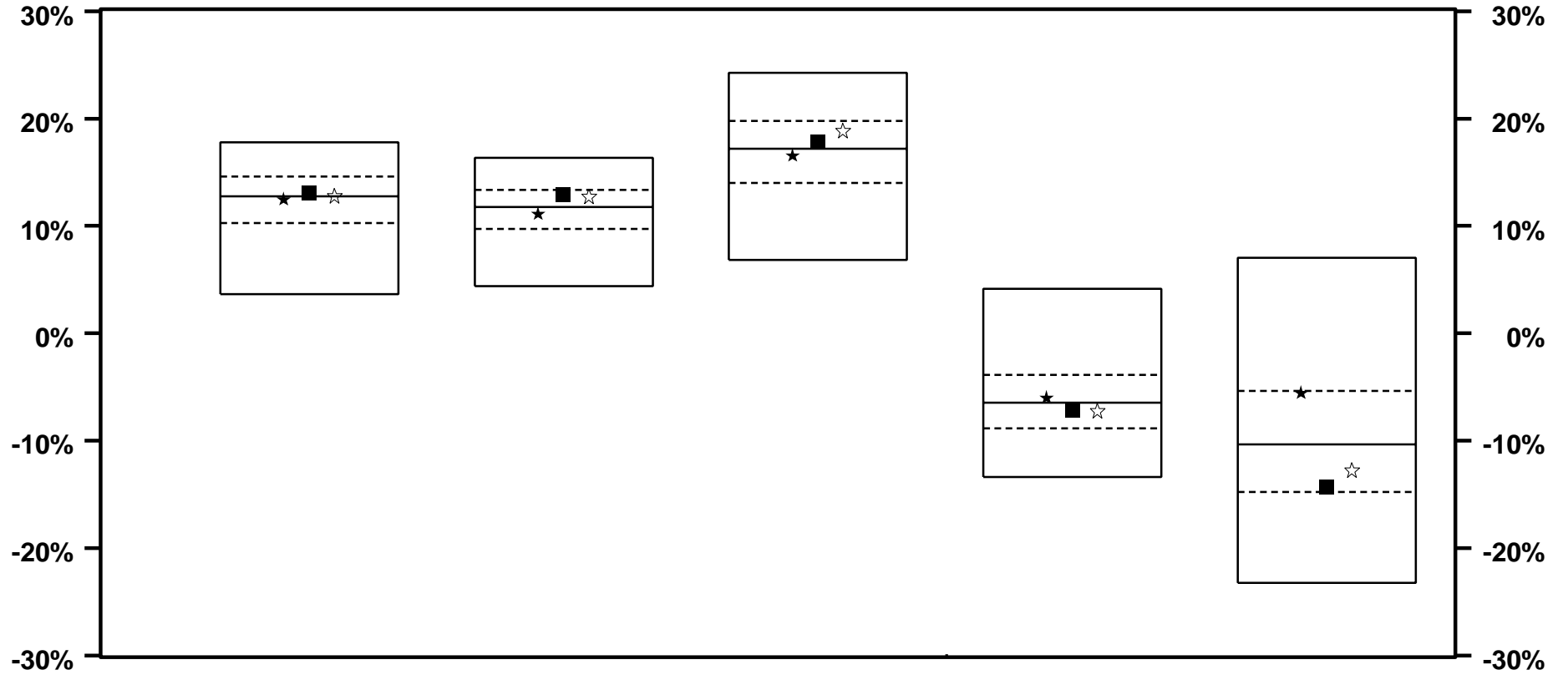

	9 / 05		9 / 04		9 / 03		9 / 02		9 / 01	
★ MUNI COMPOSITE	12.5	55	11.1	59	16.6	56	-5.9	44	-5.5	25
■ ALLOC INDEX	13.1	45	12.9	30	17.8	43	-7.1	57	-14.3	72
☆ POLICY INDEX	12.8	48	12.8	33	18.9	32	-7.2	58	-12.7	63
MEDIAN	12.8		11.8		17.2		-6.5		-10.3	

VERMONT MUNICIPAL EMPLOYEES

TOTAL FUNDS - TOTAL RATES OF RETURN

YEARS ENDING

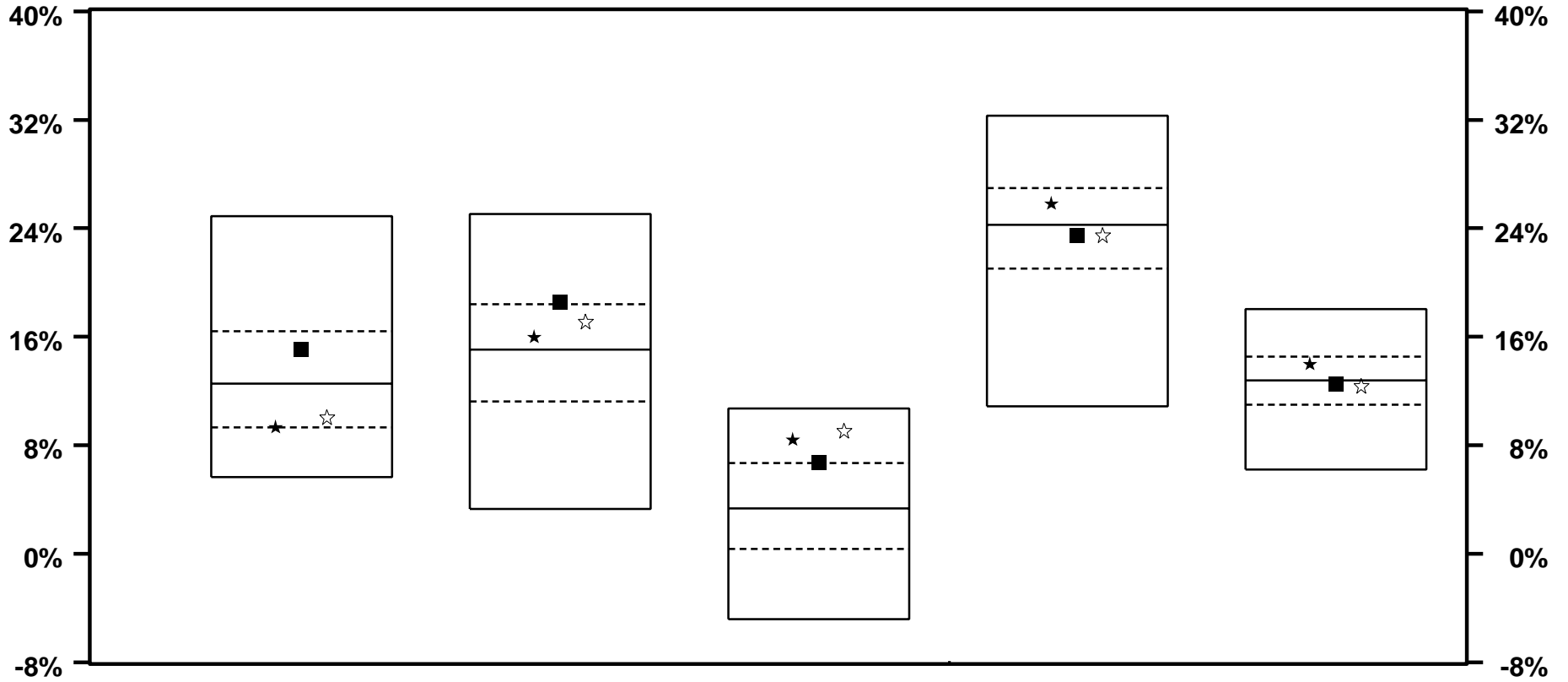

	9 / 00		9 / 99		9 / 98		9 / 97		9 / 96	
★ MUNI COMPOSITE	9.3	74	16.0	42	8.4	14	25.8	34	14.0	30
■ ALLOC INDEX	15.1	31	18.5	23	6.7	24	23.5	57	12.5	54
☆ POLICY INDEX	10.1	69	17.1	33	9.1	10	23.5	56	12.4	55
MEDIAN	12.6		15.1		3.4		24.3		12.8	

VERMONT MUNICIPAL EMPLOYEES

TOTAL FUNDS - TOTAL VS EQUITY ONLY RETURNS

MARKET CYCLE PERFORMANCE COMPARISONS

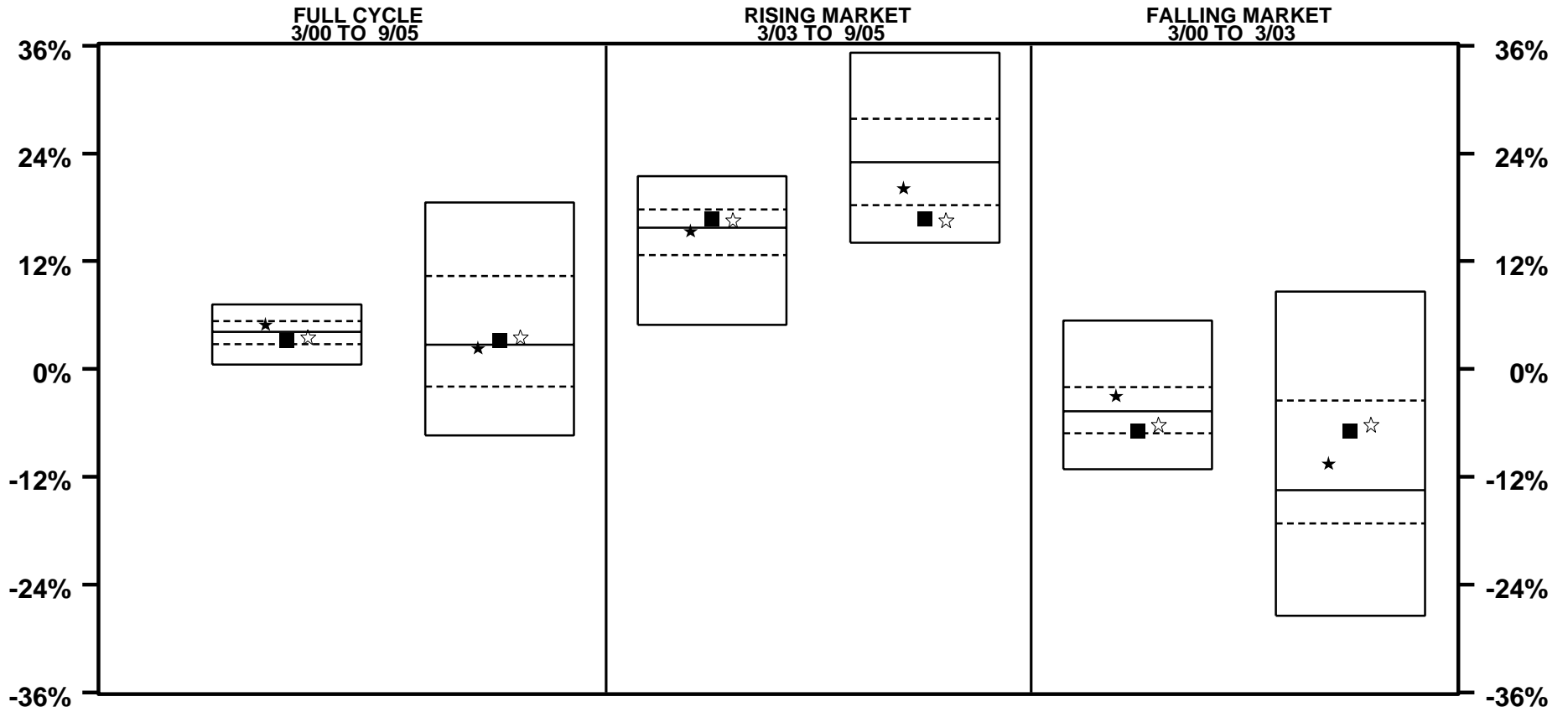

	TOTAL FUND		EQUITY ONLY		TOTAL FUND		EQUITY ONLY		TOTAL FUND		EQUITY ONLY	
★ MUNI COMPOSITE	5.0	31	2.3	51	15.4	56	20.2	66	-3.0	32	-10.5	42
■ ALLOC INDEX	3.2	68	3.2	48	16.7	35	16.7	88	-6.9	73	-6.9	32
☆ POLICY INDEX	3.6	59	3.6	46	16.6	37	16.6	89	-6.1	64	-6.1	30
MEDIAN	4.1		2.7		15.7		23.0		-4.7		-13.5	

VERMONT MUNICIPAL EMPLOYEES

TOTAL FUNDS - TOTAL VS BOND ONLY RETURNS

MARKET CYCLE PERFORMANCE COMPARISONS

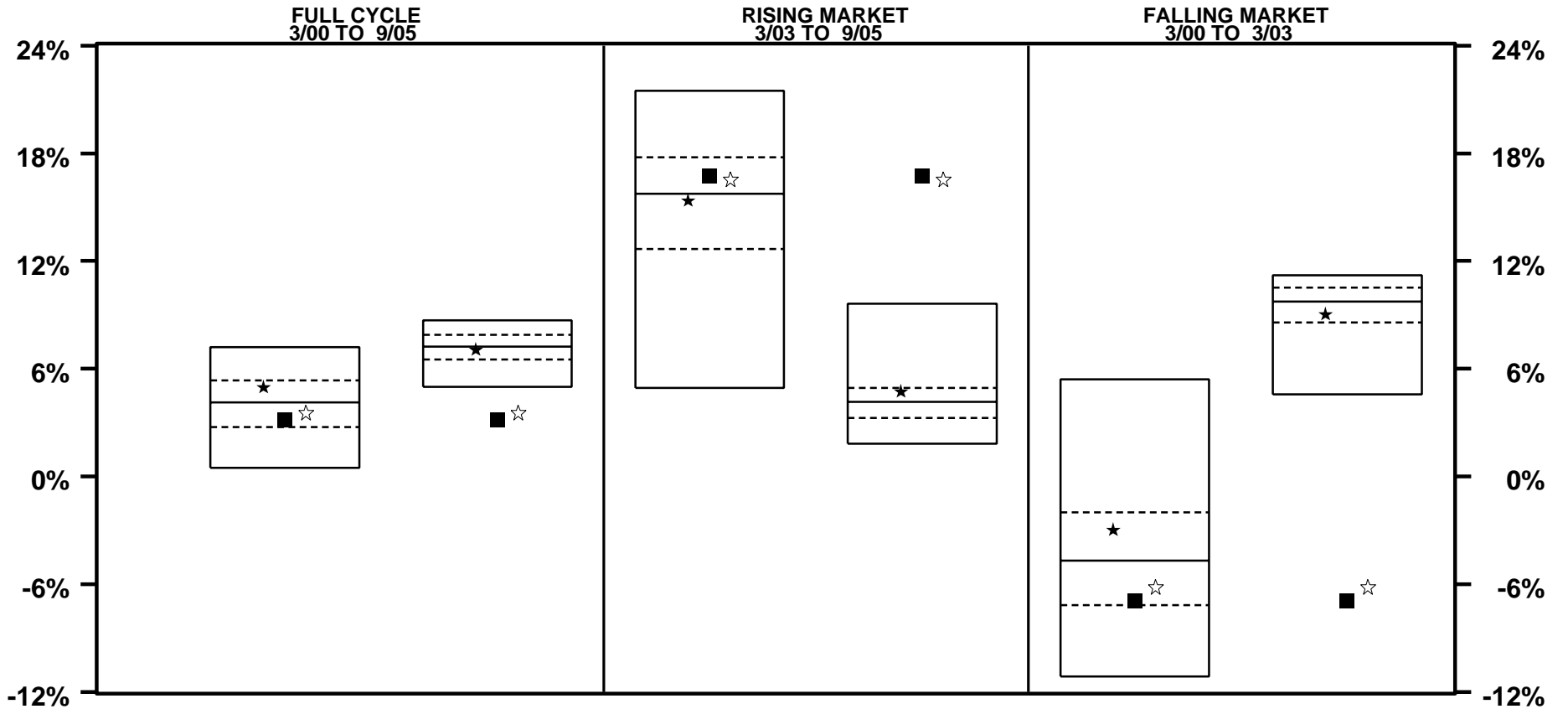

	TOTAL FUND		BONDS ONLY		TOTAL FUND		BONDS ONLY		TOTAL FUND		BONDS ONLY	
★ MUNI COMPOSITE	5.0	31	7.1	56	15.4	56	4.7	35	-3.0	32	9.0	67
■ ALLOC INDEX	3.2	68	3.2	99	16.7	35	16.7	1	-6.9	73	-6.9	99
☆ POLICY INDEX	3.6	59	3.6	99	16.6	37	16.6	1	-6.1	64	-6.1	99
MEDIAN	4.1		7.2		15.7		4.2		-4.7		9.8	

VERMONT MUNICIPAL EMPLOYEES

TOTAL FUNDS - TOTAL RATES OF RETURN

EFFECTS OF EQUITY ALLOCATION ON RATE OF RETURN

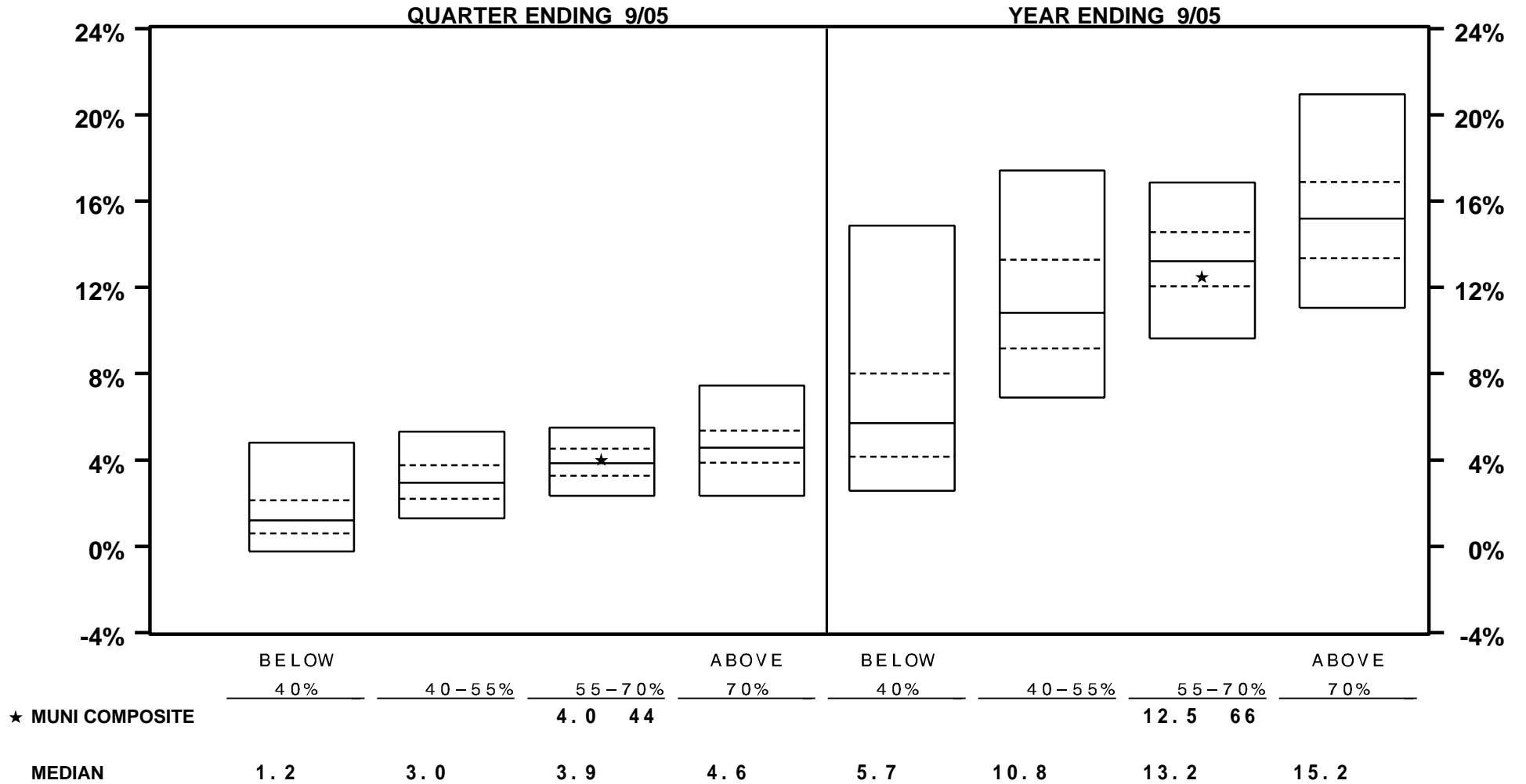

VERMONT MUNICIPAL EMPLOYEES

TOTAL FUNDS - TOTAL RATES OF RETURN

EFFECTS OF EQUITY ALLOCATION ON RATE OF RETURN

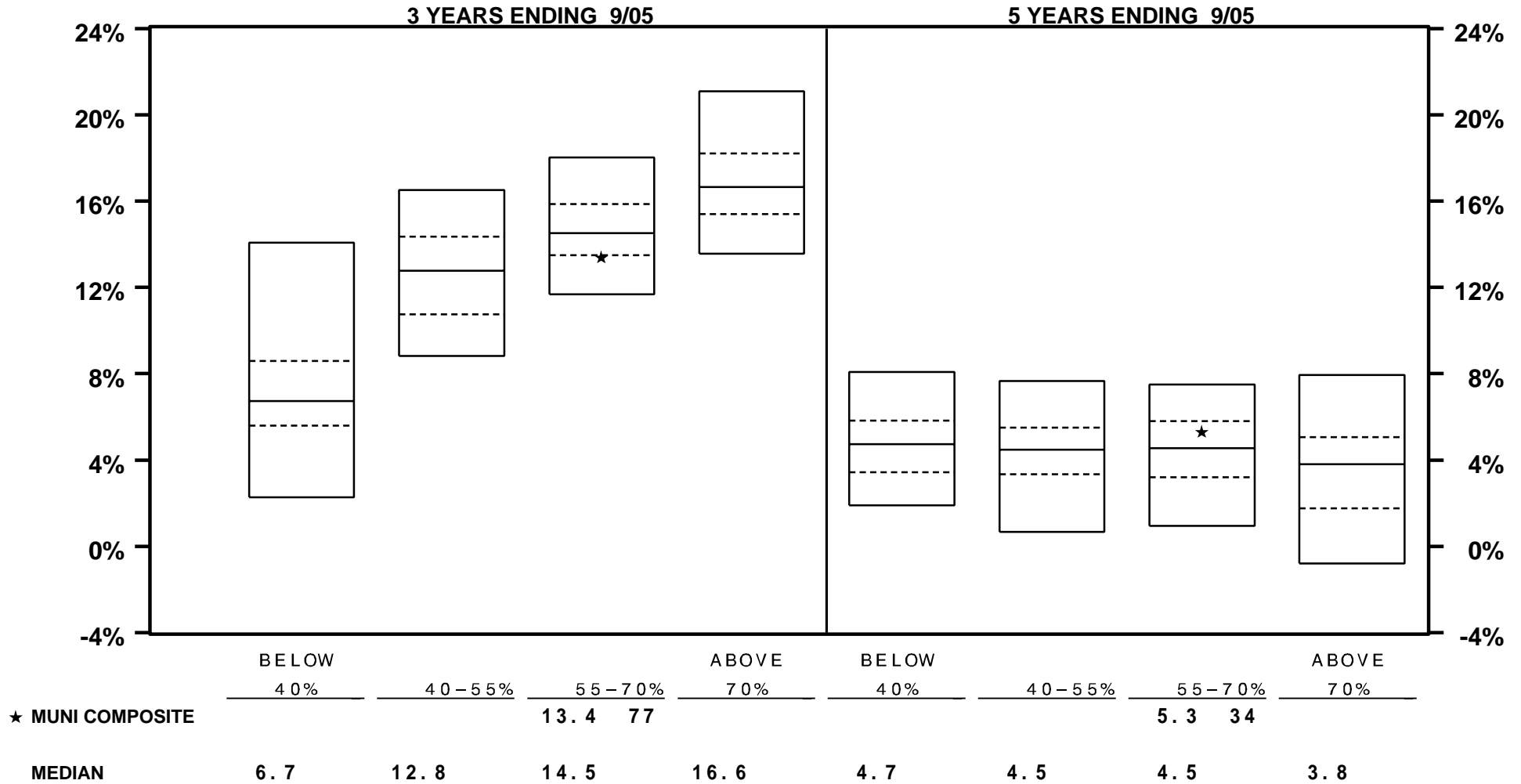

VERMONT MUNICIPAL EMPLOYEES

TOTAL FUNDS - TOTAL FUND INCOME RATES OF RETURN FOR PERIOD ENDING 9/05

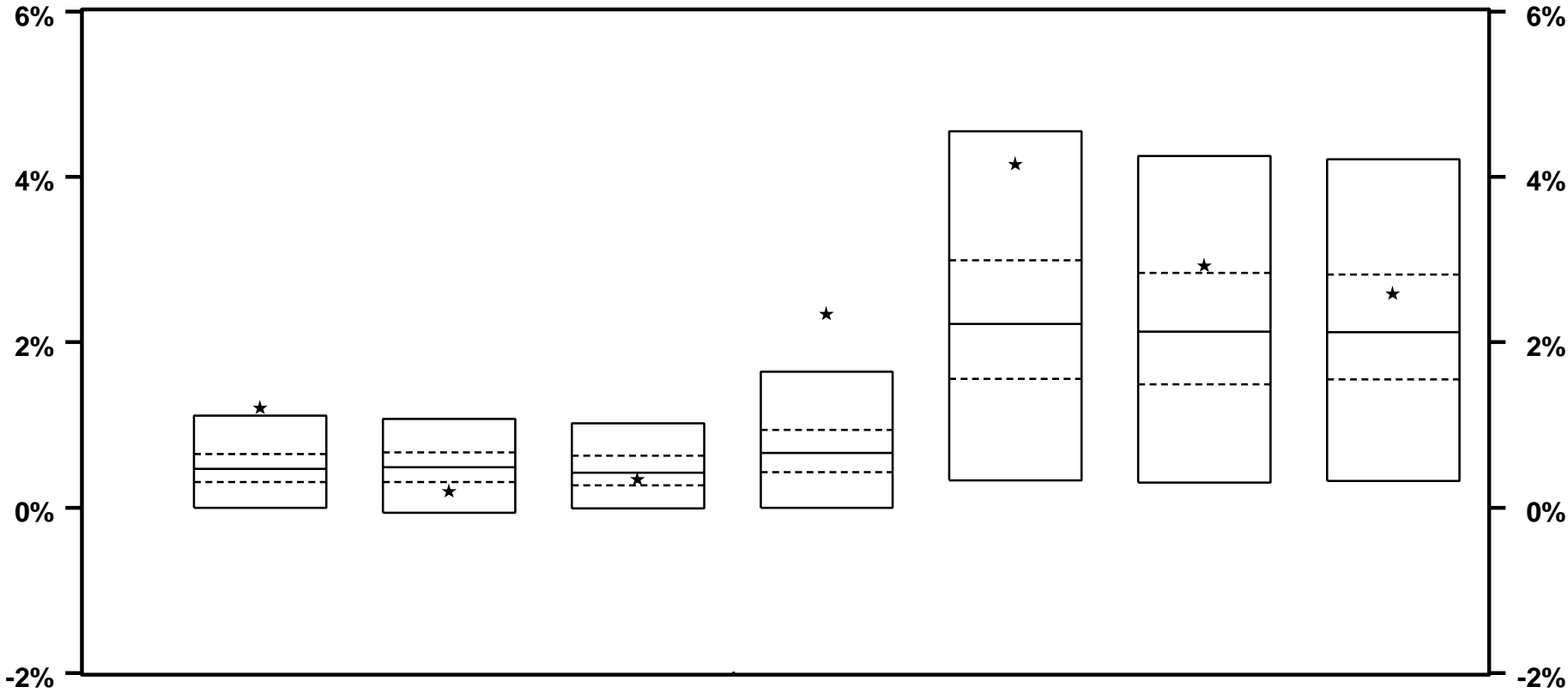

	<u>THIS QUARTER</u>	<u>LAST QUARTER</u>	<u>2 QTRS AGO</u>	<u>3 QTRS AGO</u>	<u>LAST YEAR</u>	<u>LAST 2 YEARS</u>	<u>LAST 3 YEARS</u>
★ MUNI COMPOSITE	1.2 3	0.2 83	0.3 61	2.3 1	4.2 7	2.9 22	2.6 31
MEDIAN	0.5	0.5	0.4	0.7	2.2	2.1	2.1

VERMONT MUNICIPAL EMPLOYEES

TOTAL FUNDS - TOTAL RETURN VS RISK

3 YEARS ENDING 9/05

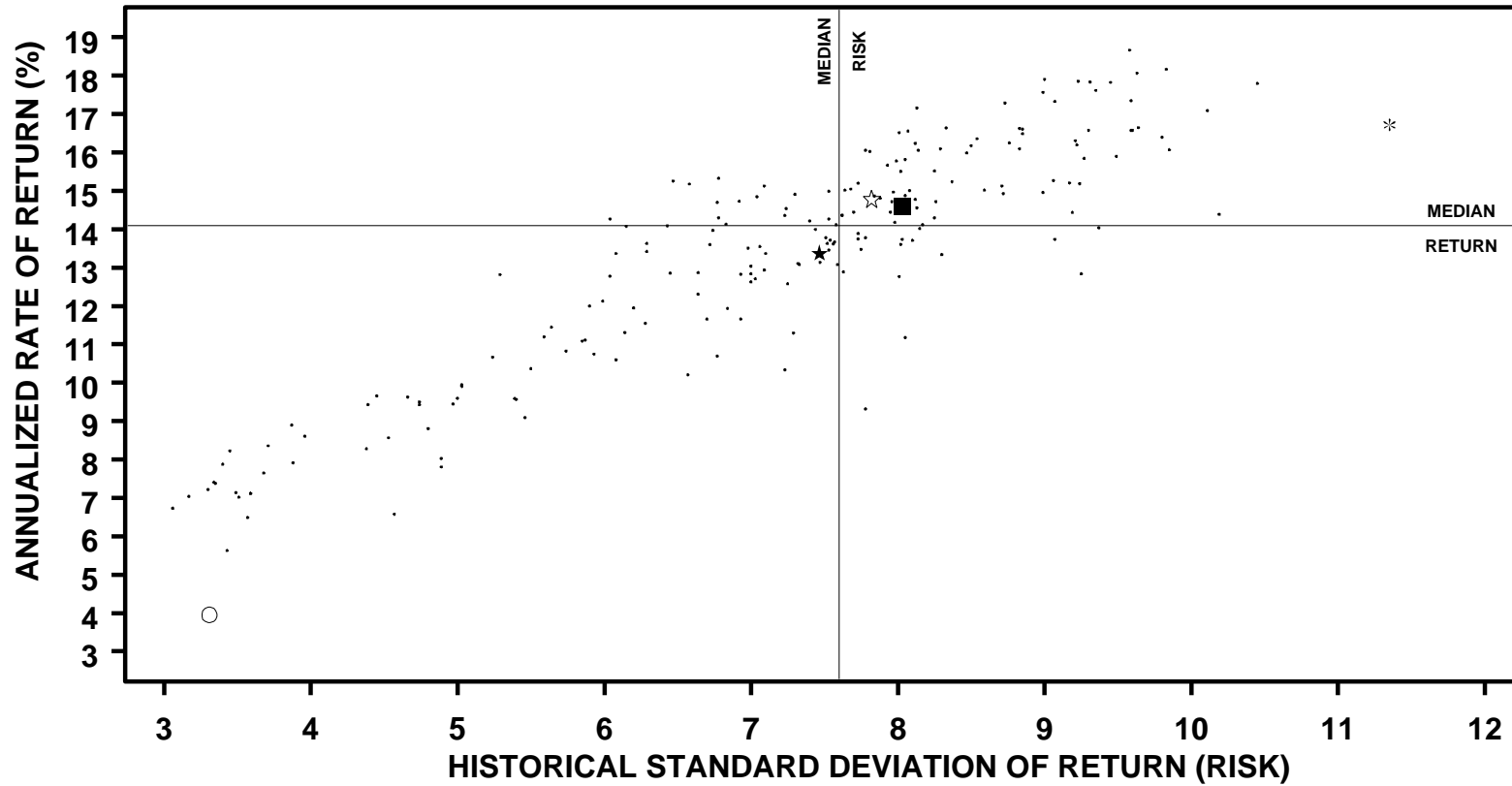

	ANNUALIZED RETURN		STANDARD DEVIATION		SHARPE RATIO	
	VALUE	RANK	VALUE	RANK	VALUE	RANK
★ MUNI COMPOSITE	13.4	60	7.5	54	1.5	60
■ ALLOC INDEX	14.6	39	8.0	35	1.6	51
☆ POLICY INDEX	14.8	36	7.8	42	1.6	36
* S&P 500	16.7	13	11.4	3	1.3	89
○ LB AGGREGATE	4.0	97	3.3	92	0.7	97
MEDIAN	14.1		7.6		1.6	

VERMONT MUNICIPAL EMPLOYEES

TOTAL FUNDS - TOTAL RETURN VS RISK

5 YEARS ENDING 9/05

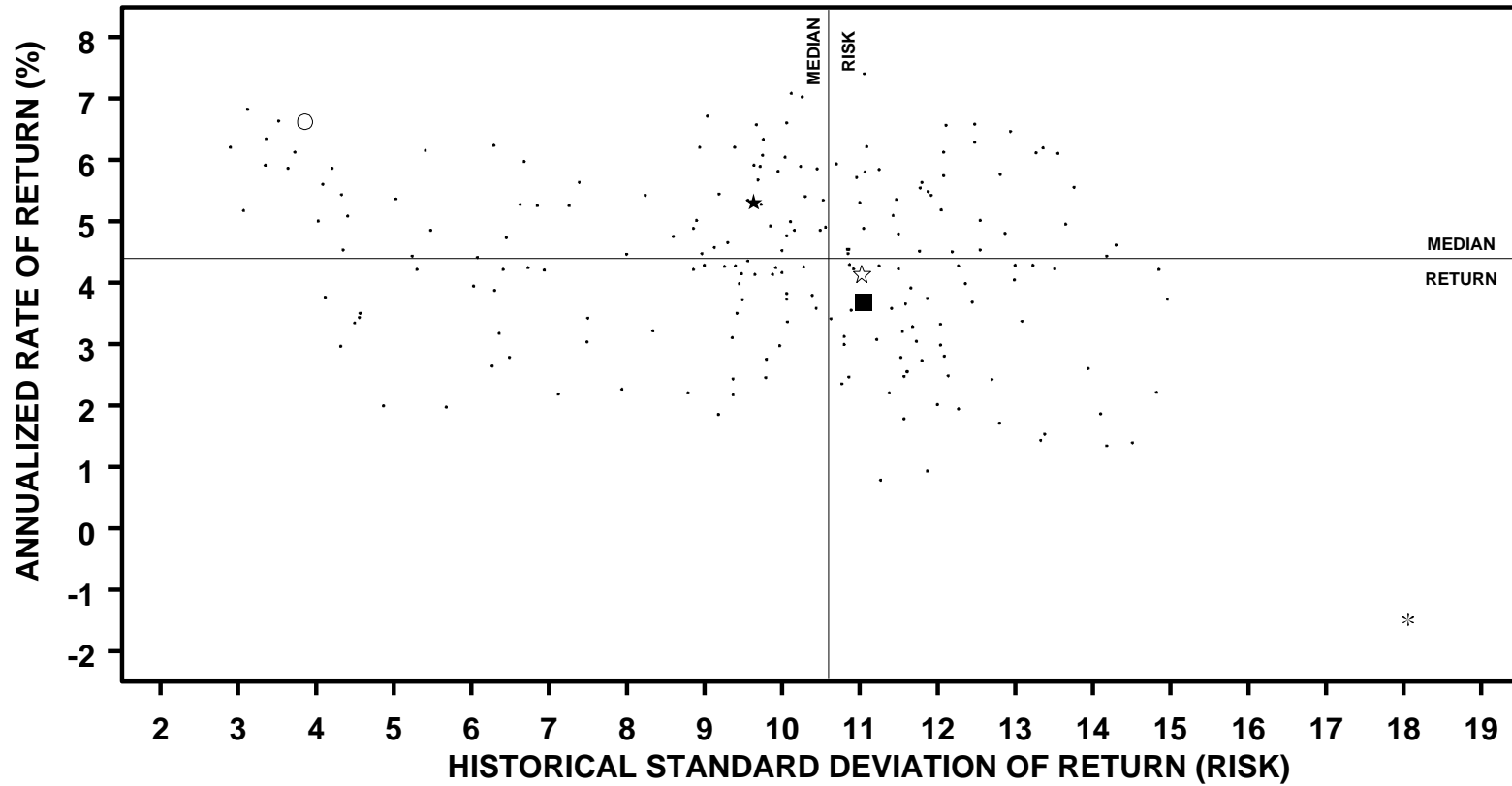

	ANNUALIZED RETURN		STANDARD DEVIATION		SHARPE RATIO	
	VALUE	RANK	VALUE	RANK	VALUE	RANK
★ MUNI COMPOSITE	5.3	33	9.6	66	0.3	31
■ ALLOC INDEX	3.7	66	11.1	42	0.2	66
☆ POLICY INDEX	4.2	56	11.0	42	0.2	57
* S&P 500	-1.5	99	18.1	1	-0.1	
○ LB AGGREGATE	6.6	9	3.9	92	1.1	1
MEDIAN	4.4		10.6		0.2	

VERMONT MUNICIPAL EMPLOYEES

EQUITY FUNDS - TOTAL RATES OF RETURN

PERIODS ENDING 9/05

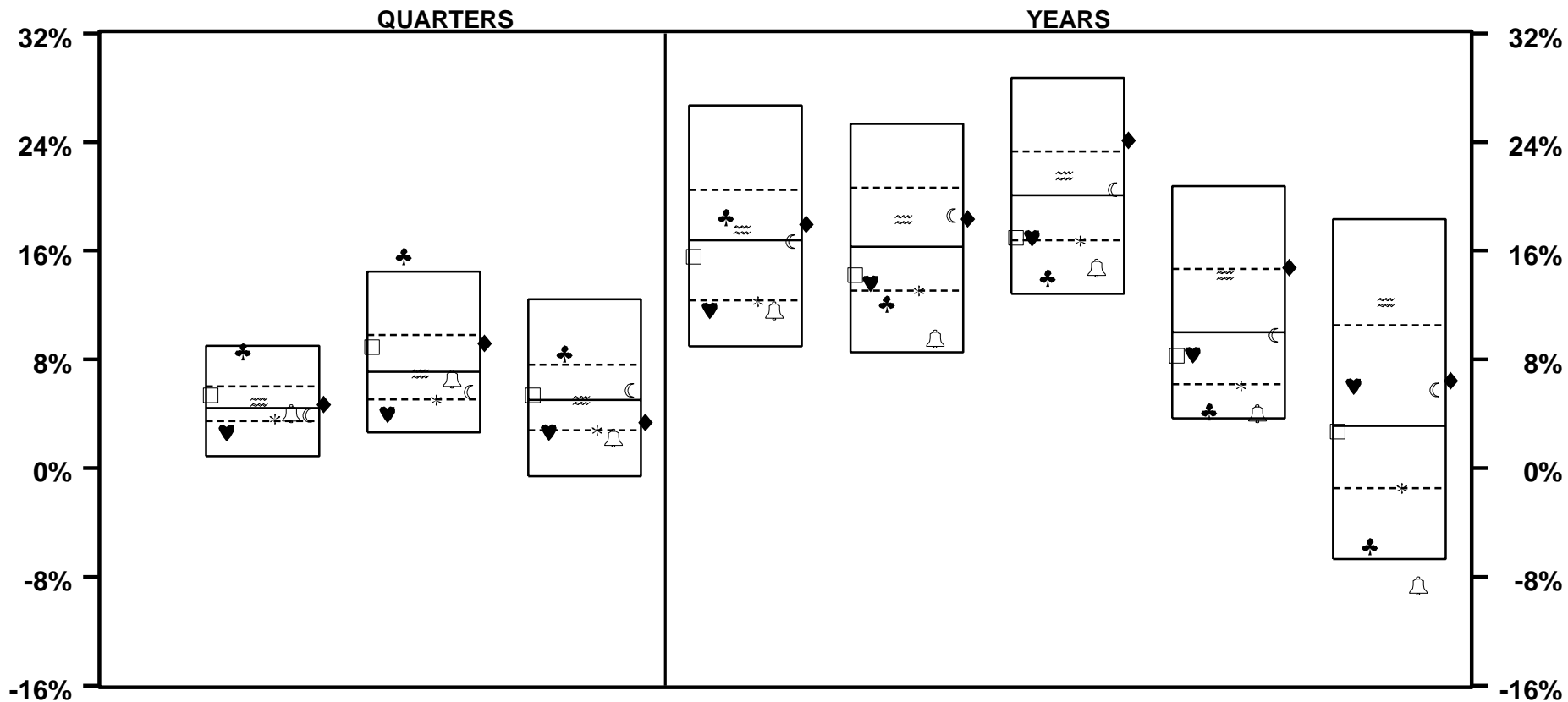

	LAST QTR		LAST 2 QTRS		LAST 3 QTRS		LAST YEAR		LAST 2 YEARS		LAST 3 YEARS		LAST 4 YEARS		LAST 5 YEARS	
□ EQTY COMPOSITE	5.4	34	8.9	32	5.4	46	15.6	57	14.2	63	17.0	70	8.3	58	2.7	51
♥ DELAWARE	2.6	85	4.0	88	2.7	79	11.6	86	13.6	67	17.0	70	8.4	58	6.1	39
♣ ALLIANCE	8.6	6	15.6	2	8.4	19	18.5	39	12.1	84	14.0	90	4.2	91	-5.7	92
≍ LAZARD	4.9	42	7.0	50	5.0	50	17.5	46	18.3	36	21.5	38	14.2	27	12.2	19
* S&P 500	3.6	70	5.0	77	2.8	77	12.3	80	13.1	76	16.7	78	6.0	82	-1.5	77
🔔 R 1000(R) GR	4.0	57	6.6	54	2.2	84	11.6	86	9.5	93	14.7	88	4.0	92	-8.6	97
☾ R 1000(R) VALUE	3.9	60	5.6	67	5.7	42	16.7	50	18.6	35	20.5	46	9.8	51	5.8	41
◆ R 2000(R)	4.7	46	9.2	30	3.4	66	18.0	43	18.4	36	24.1	20	14.8	24	6.4	38
MEDIAN	4.4		7.1		5.0		16.8		16.3		20.1		10.0		3.1	

VERMONT MUNICIPAL EMPLOYEES

EQUITY FUNDS - TOTAL RATES OF RETURN

PERIODS ENDING 9/05

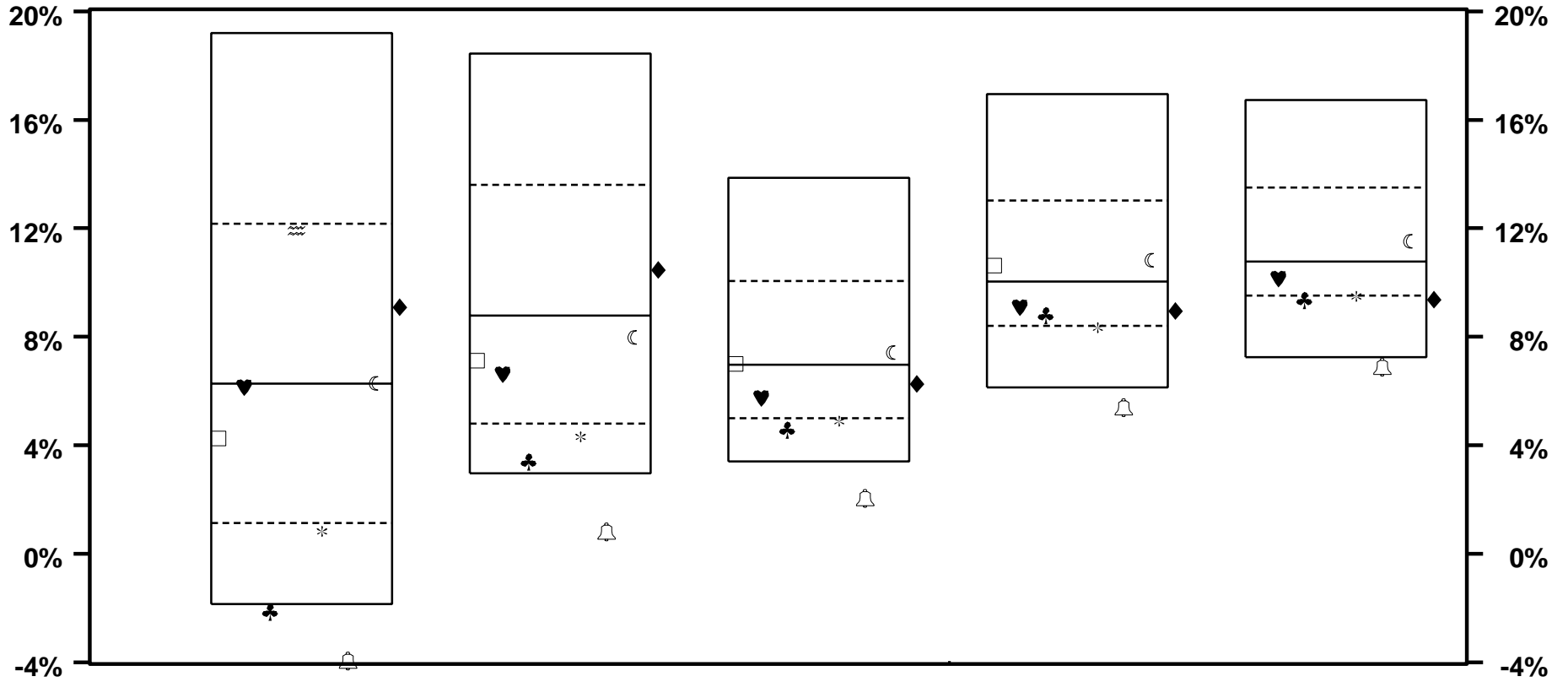

	LAST 6 YEARS		LAST 7 YEARS		LAST 8 YEARS		LAST 9 YEARS		LAST 10 YEARS	
□ EQTY COMPOSITE	4.3	60	7.1	60	7.0	49	10.6	42		
♥ DELAWARE	6.1	51	6.6	63	5.7	64	9.1	61	10.2	60
♣ ALLIANCE	-2.1	95	3.4	93	4.6	87	8.8	64	9.4	82
≍ LAZARD	11.9	25								
* S&P 500	0.8	84	4.3	85	4.9	81	8.3	78	9.5	77
🔔 R 1000(R) GR	-3.9	98	0.8	99	2.1	98	5.4	97	6.9	97
☾ R 1000(R) VALUE	6.3	50	8.0	54	7.4	44	10.8	40	11.5	41
◆ R 2000(R)	9.1	36	10.5	40	6.3	58	9.0	62	9.4	81
MEDIAN	6.3		8.8		7.0		10.0		10.8	

VERMONT MUNICIPAL EMPLOYEES

EQUITY FUNDS - TOTAL RATES OF RETURN

YEARS ENDING

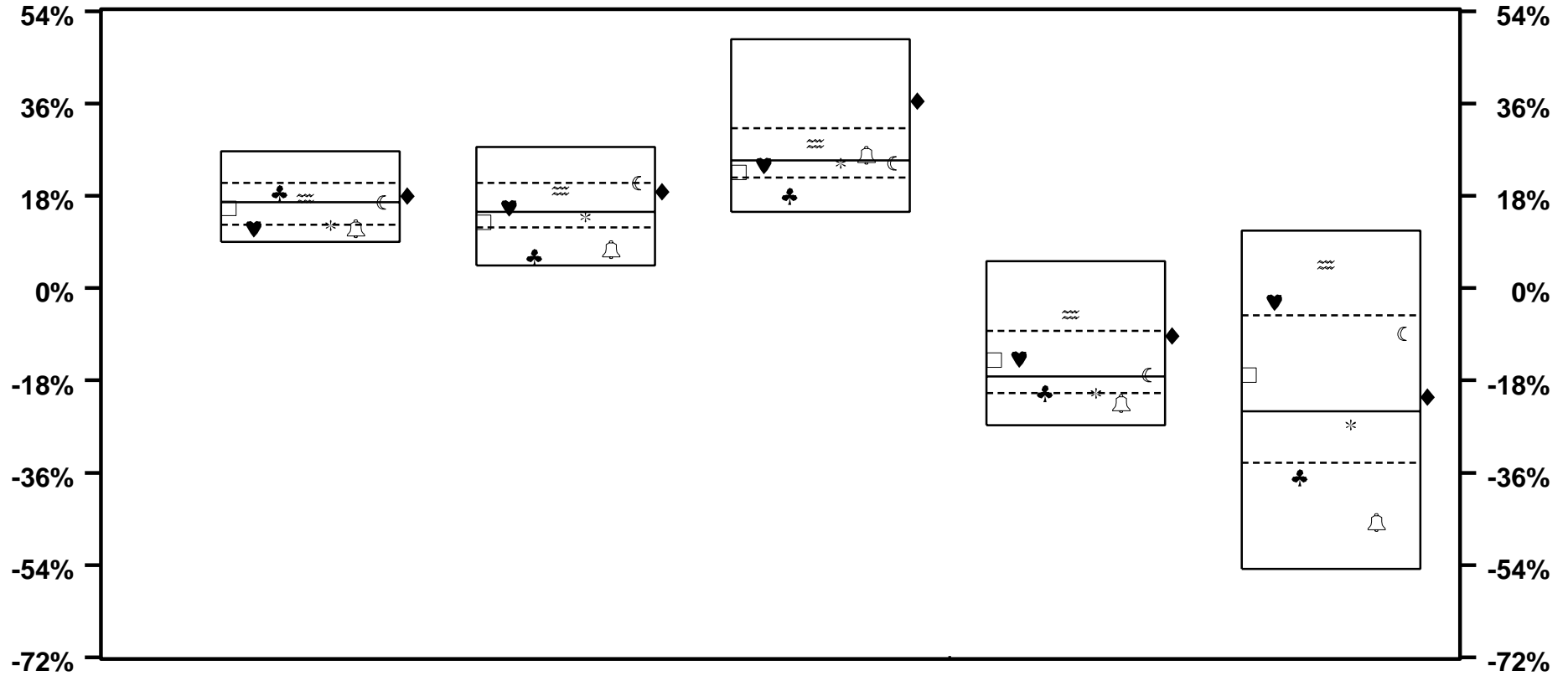

	9 / 05		9 / 04		9 / 03		9 / 02		9 / 01	
□ EQTY COMPOSITE	15.6	57	12.9	69	22.6	69	-14.0	39	-16.9	40
♥ DELAWARE	11.6	86	15.7	46	24.0	63	-13.8	38	-2.7	21
♣ ALLIANCE	18.5	39	6.1	92	18.0	89	-20.5	75	-36.9	78
≡ LAZARD	17.5	46	19.1	31	28.2	32	-5.2	18	4.6	12
* S&P 500	12.3	80	13.9	59	24.4	56	-20.5	74	-26.6	61
🔔 R 1000(R) GR	11.6	86	7.5	88	25.9	44	-22.5	86	-45.6	88
☾ R 1000(R) VALUE	16.7	50	20.5	25	24.4	58	-17.0	49	-8.9	28
◆ R 2000(R)	18.0	43	18.8	32	36.5	13	-9.3	27	-21.2	46
MEDIAN	16.8		14.8		24.9		-17.2		-24.0	

VERMONT MUNICIPAL EMPLOYEES

EQUITY FUNDS - TOTAL RATES OF RETURN

YEARS ENDING

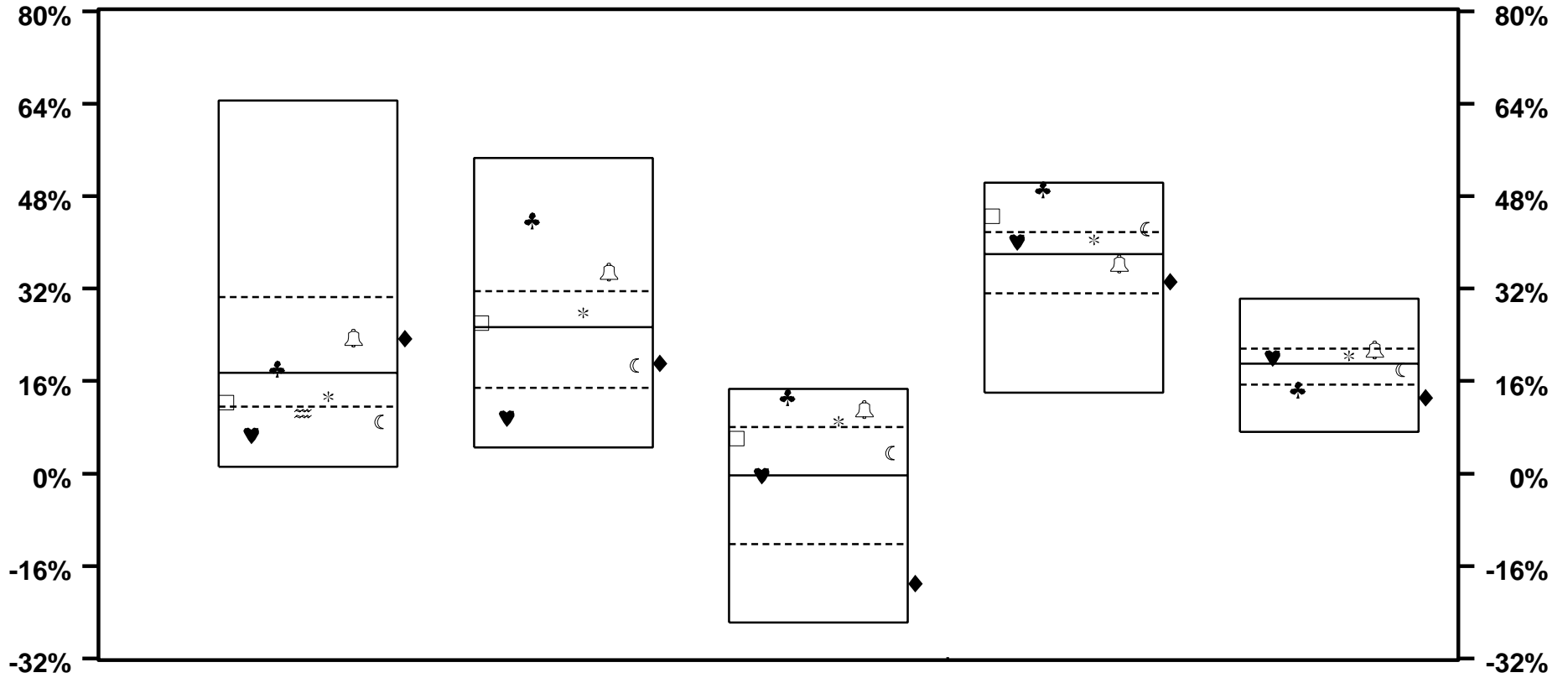

	9 / 00		9 / 99		9 / 98		9 / 97		9 / 96	
□ EQTY COMPOSITE	12.3	72	26.1	47	6.1	29	44.6	15		
♥ DELAWARE	6.6	86	9.6	87	-0.3	49	40.1	38	20.1	42
♣ ALLIANCE	18.1	47	43.8	10	13.2	6	49.2	6	14.5	79
≡ LAZARD	10.4	77								
* S&P 500	13.3	66	27.8	39	9.0	20	40.4	34	20.3	37
🔔 R 1000(R) GR	23.4	36	34.9	19	11.1	10	36.3	56	21.4	26
☾ R 1000(R) VALUE	8.9	81	18.7	66	3.6	35	42.3	22	17.9	57
◆ R 2000(R)	23.4	36	19.1	65	-19.0	86	33.2	69	13.1	84
MEDIAN	17.4		25.3		-0.4		38.0		19.0	

VERMONT MUNICIPAL EMPLOYEES

EQUITY FUNDS - TOTAL VS EQUITY ONLY RETURNS

MARKET CYCLE PERFORMANCE COMPARISONS

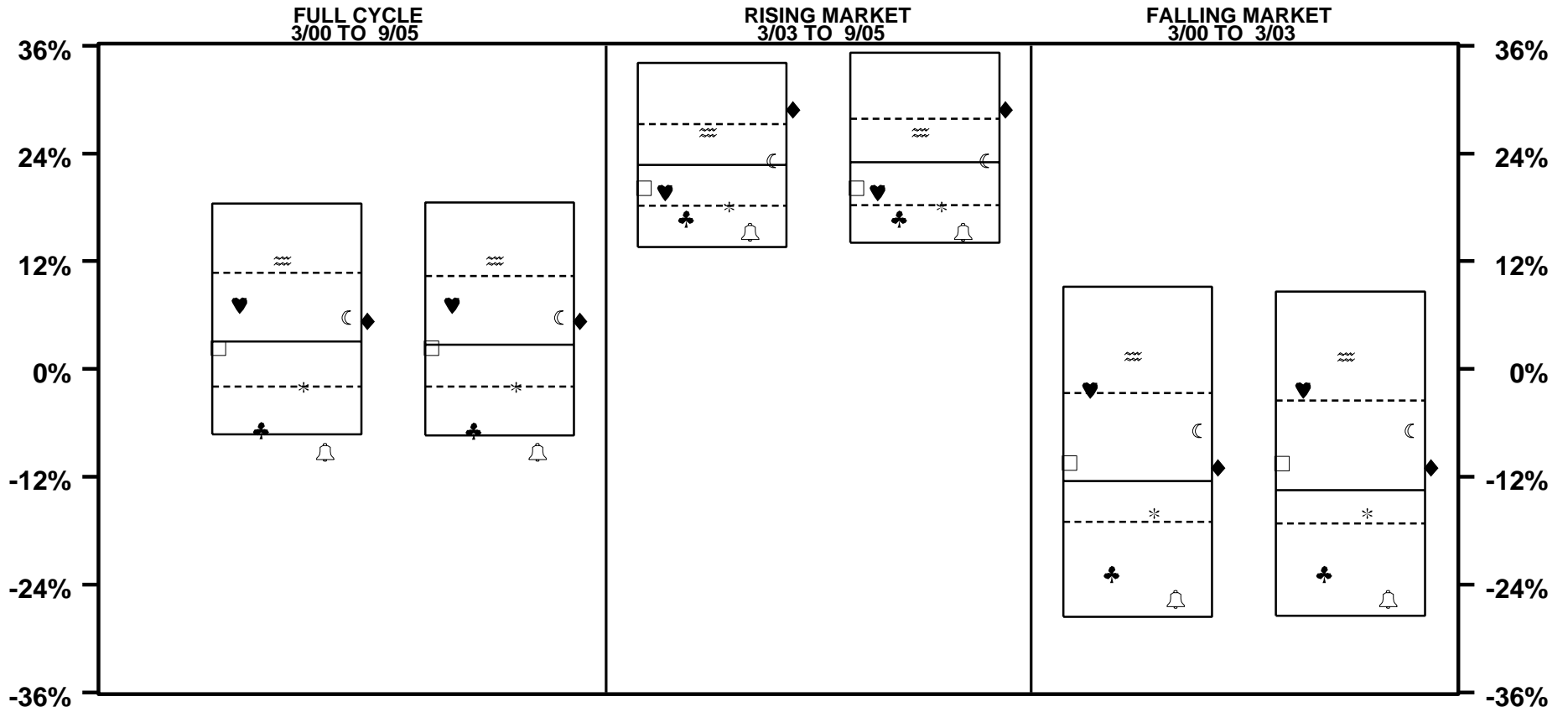

	TOTAL FUND		EQUITY ONLY		TOTAL FUND		EQUITY ONLY		TOTAL FUND		EQUITY ONLY	
□ EQTY COMPOSITE	2.3	52	2.3	51	20.2	65	20.2	66	-10.5	44	-10.5	42
♥ DELAWARE	7.1	36	7.1	34	19.6	68	19.7	68	-2.3	24	-2.3	22
♣ ALLIANCE	-6.8	93	-6.8	93	16.7	87	16.7	88	-22.8	87	-22.8	87
≡ LAZARD	12.1	22	12.0	21	26.3	30	26.3	32	1.4	17	1.4	15
* S&P 500	-2.0	77	-2.0	76	18.1	79	18.1	81	-16.1	68	-16.1	68
🔔 R 1000(R) GR	-9.3	97	-9.3	97	15.2	91	15.2	92	-25.6	92	-25.6	92
☾ R 1000(R) VALUE	5.8	41	5.8	38	23.2	47	23.2	48	-6.9	34	-6.9	32
◆ R 2000(R)	5.3	42	5.3	40	28.9	17	28.9	19	-11.0	46	-11.0	44
MEDIAN	3.1		2.7		22.7		23.0		-12.5		-13.5	

VERMONT MUNICIPAL EMPLOYEES

EQUITY FUNDS - TOTAL FUND INCOME RATES OF RETURN FOR PERIOD ENDING 9/05

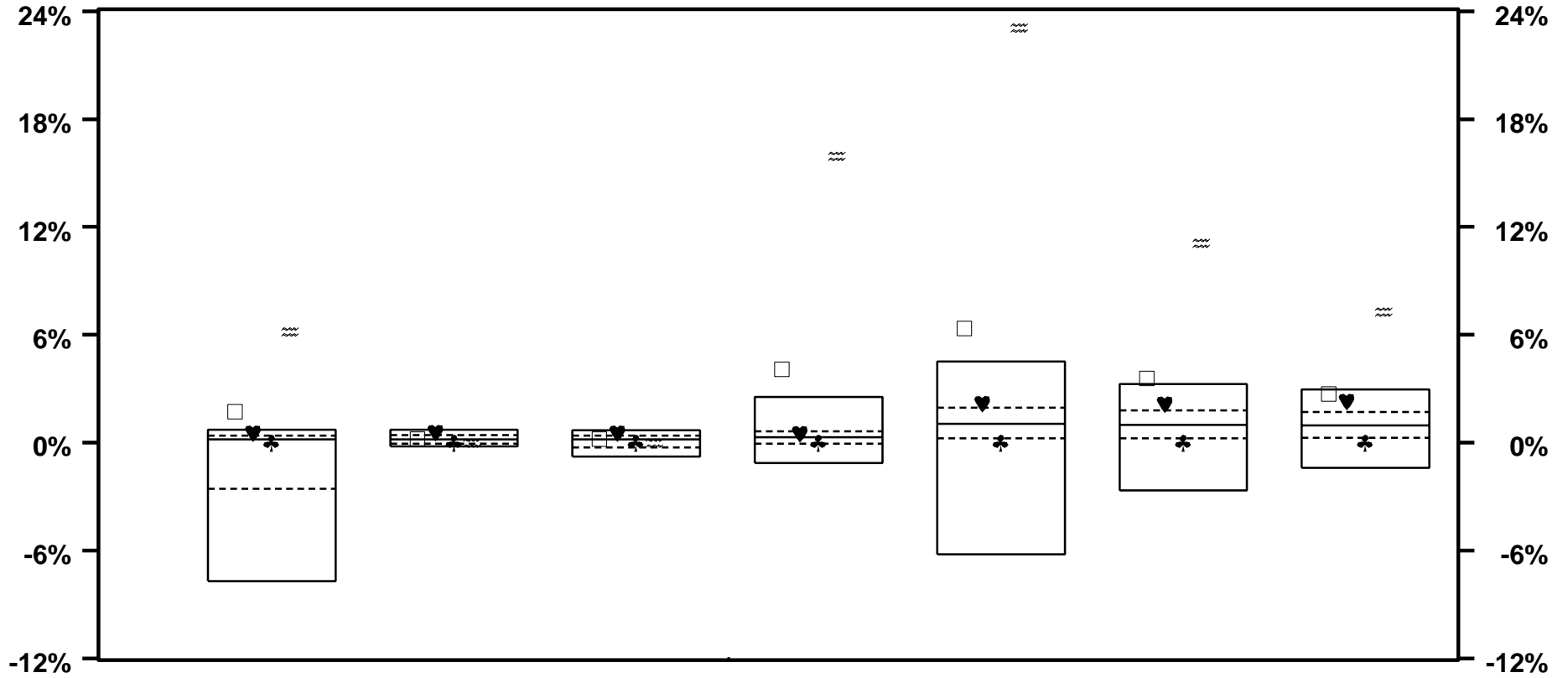

	THIS QUARTER		LAST QUARTER		2 QTRS AGO		3 QTRS AGO		LAST YEAR		LAST 2 YEARS		LAST 3 YEARS	
□ EQTY COMPOSITE	1.7	1	0.2	46	0.2	43	4.1	2	6.4	2	3.6	4	2.7	6
♥ DELAWARE	0.5	9	0.6	11	0.5	9	0.5	33	2.2	17	2.2	14	2.3	11
♣ ALLIANCE	0.0	65	0.0	65	0.0	64	0.0	74	0.0	79	0.0	81	0.0	83
≡ LAZARD	6.2	1	0.0	65	0.0	64	15.9	1	23.1	1	11.1	1	7.3	1
MEDIAN	0.2		0.2		0.2		0.3		1.1		1.0		1.0	

VERMONT MUNICIPAL EMPLOYEES

EQUITY FUNDS - TOTAL RETURN VS RISK

3 YEARS ENDING 9/05

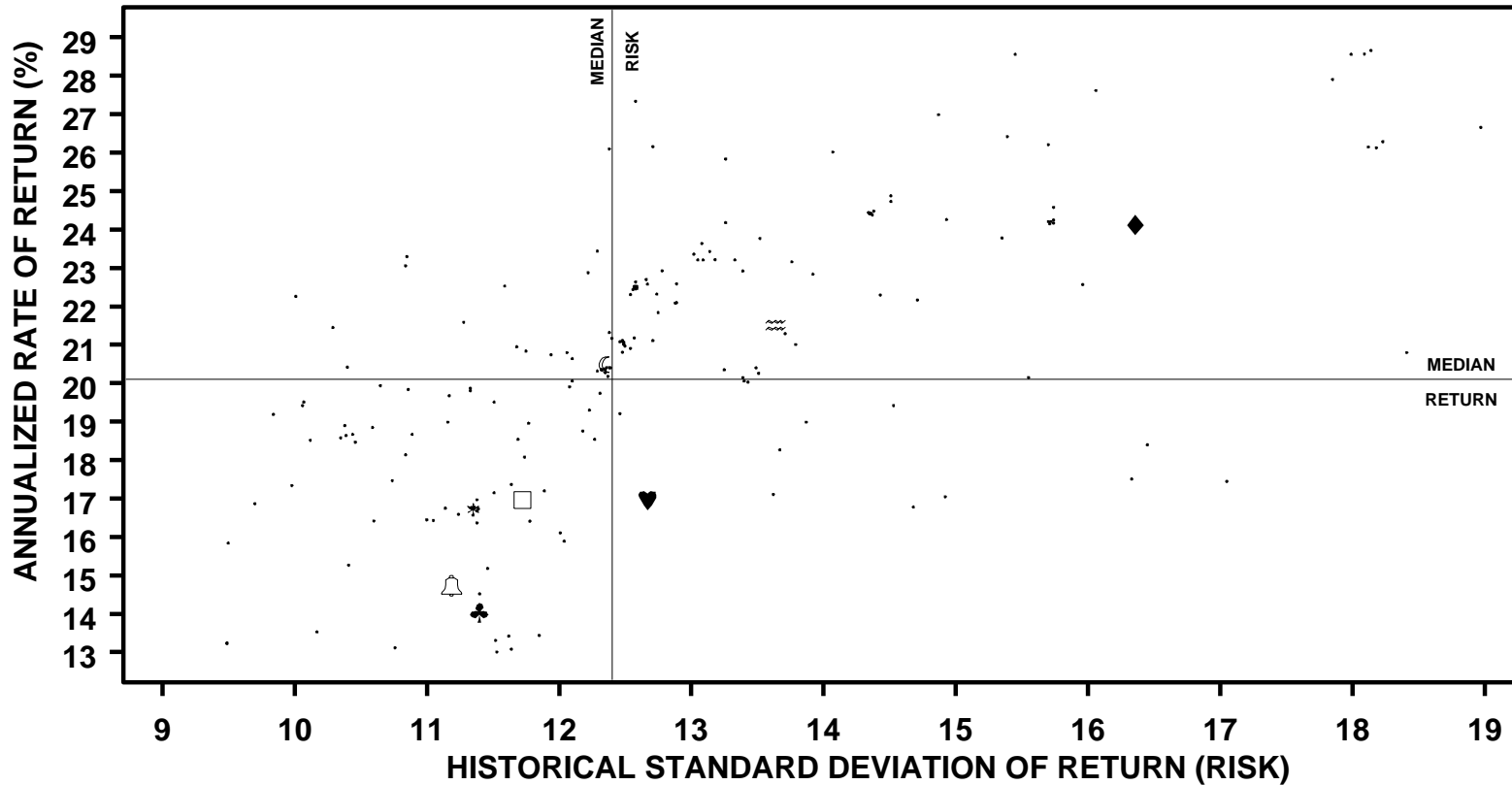

	ANNUALIZED RETURN		STANDARD DEVIATION		SHARPE RATIO	
	VALUE	RANK	VALUE	RANK	VALUE	RANK
□ EQTY COMPOSITE	17.0	70	11.7	62	1.3	71
♥ DELAWARE	17.0	70	12.7	44	1.2	80
♣ ALLIANCE	14.0	90	11.4	68	1.1	88
≈ LAZARD	21.5	38	13.6	32	1.4	41
* S&P 500	16.7	78	11.4	71	1.3	63
🔔 R 1000(R) GR	14.7	88	11.2	79	1.2	83
☾ R 1000(R) VALUE	20.5	46	12.3	52	1.5	34
◆ R 2000(R)	24.1	20	16.4	13	1.3	54
MEDIAN	20.1		12.4		1.4	

VERMONT MUNICIPAL EMPLOYEES

EQUITY FUNDS - TOTAL RETURN VS RISK

5 YEARS ENDING 9/05

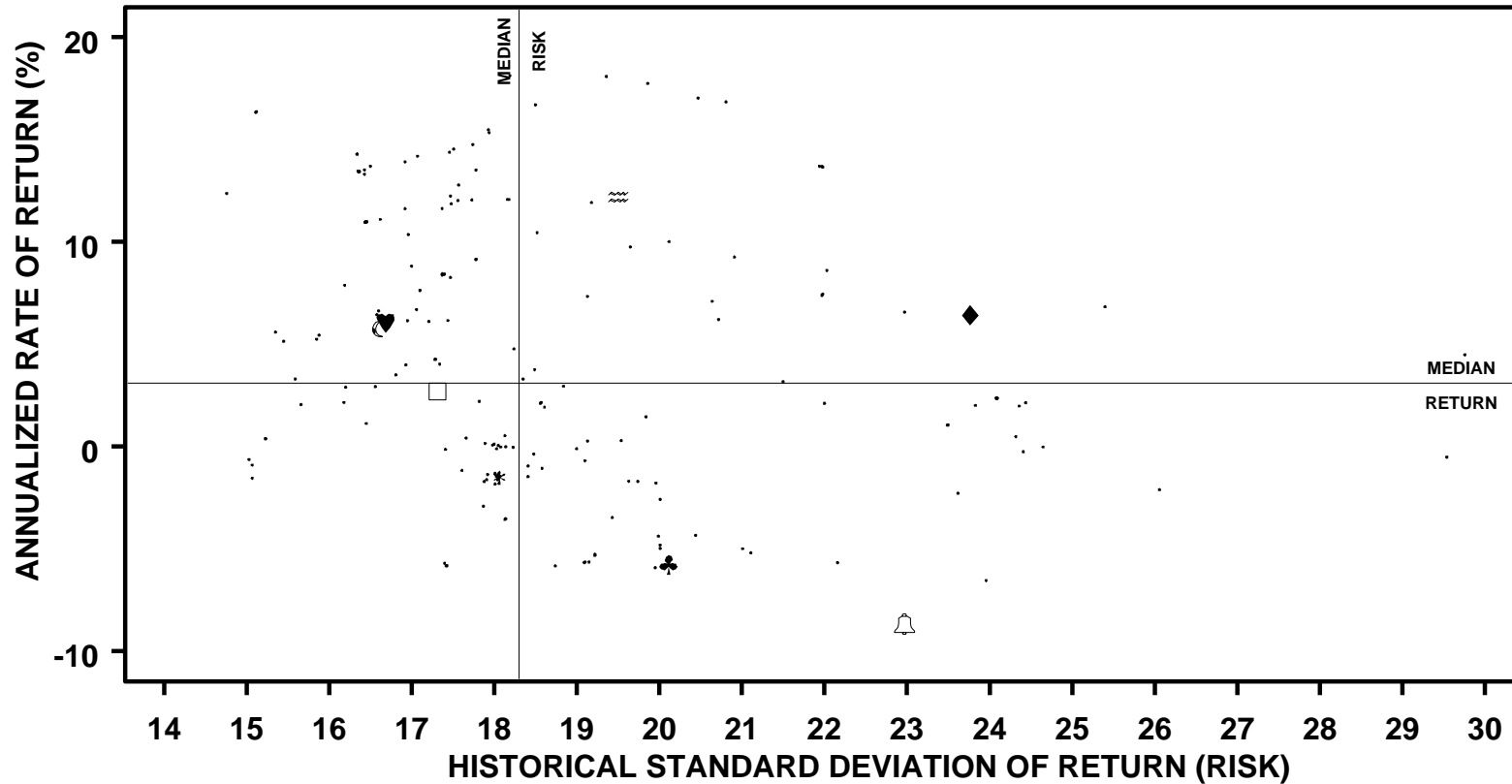

	ANNUALIZED RETURN		STANDARD DEVIATION		SHARPE RATIO	
	VALUE	RANK	VALUE	RANK	VALUE	RANK
□ EQTY COMPOSITE	2.7	51	17.3	72	0.1	53
♥ DELAWARE	6.1	39	16.7	78	0.3	39
♣ ALLIANCE	-5.7	92	20.1	33	-0.3	
≍ LAZARD	12.2	19	19.5	39	0.6	20
* S&P 500	-1.5	77	18.1	54	-0.1	
🔔 R 1000(R) GR	-8.6	97	23.0	20	-0.4	
☾ R 1000(R) VALUE	5.8	41	16.6	79	0.3	41
◆ R 2000(R)	6.4	38	23.8	17	0.3	40
MEDIAN	3.1		18.3		0.1	

VERMONT MUNICIPAL EMPLOYEES

EQUITY ONLY - RATES OF RETURN

PERIODS ENDING 9/05

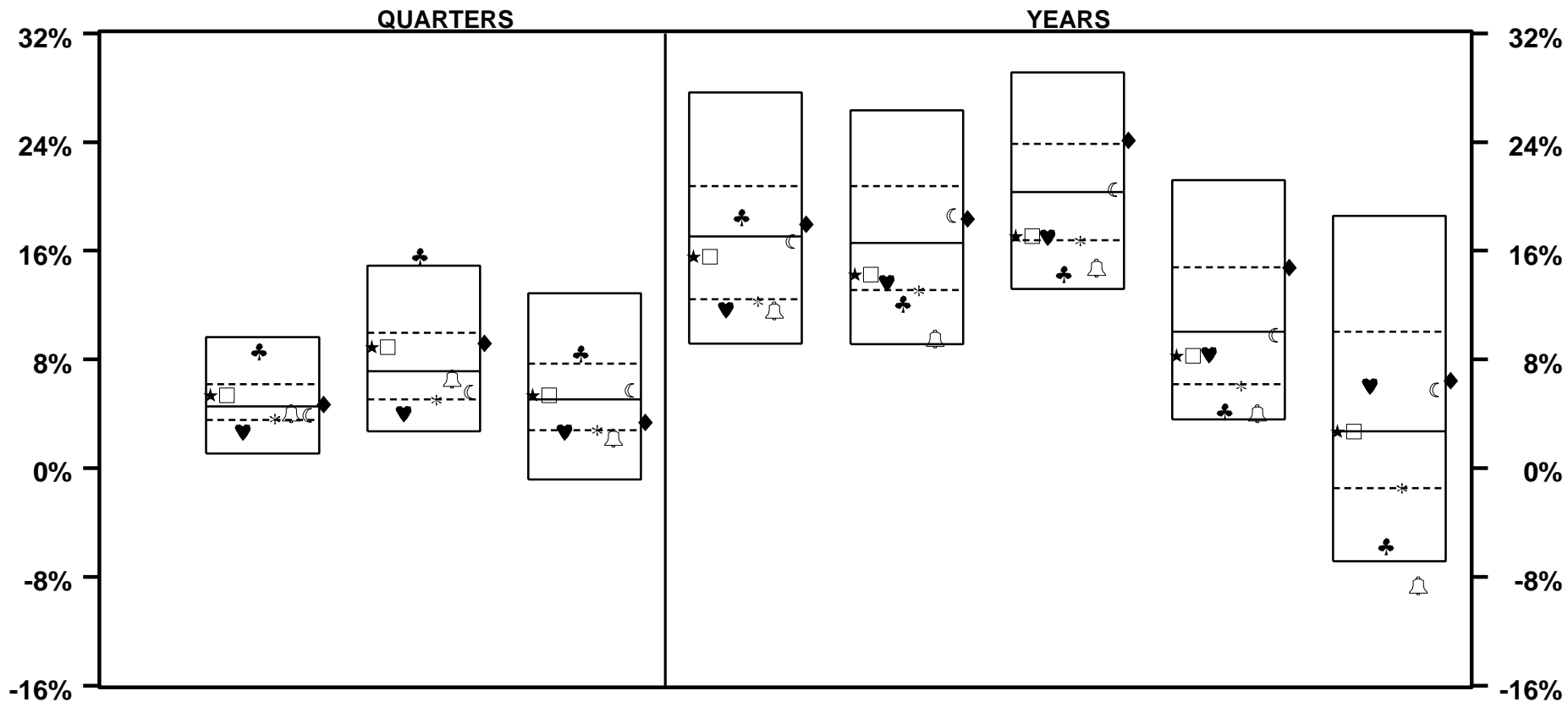

	LAST QTR		LAST 2 QTRS		LAST 3 QTRS		LAST YEAR		LAST 2 YEARS		LAST 3 YEARS		LAST 4 YEARS		LAST 5 YEARS	
★ MUNI COMPOSITE	5.4	36	8.9	33	5.4	46	15.6	58	14.2	64	17.1	70	8.3	58	2.7	50
□ EQTY COMPOSITE	5.4	36	8.9	33	5.4	46	15.6	58	14.2	64	17.1	70	8.3	58	2.7	50
♥ DELAWARE	2.7	86	4.0	88	2.7	79	11.7	87	13.7	68	17.0	71	8.4	58	6.1	37
♣ ALLIANCE	8.6	7	15.6	3	8.4	20	18.5	41	12.1	85	14.3	90	4.2	91	-5.8	92
* S&P 500	3.6	71	5.0	77	2.8	77	12.3	81	13.1	77	16.7	79	6.0	82	-1.5	77
🔔 R 1000(R) GR	4.0	59	6.6	54	2.2	84	11.6	87	9.5	93	14.7	89	4.0	93	-8.6	97
☾ R 1000(R) VALUE	3.9	61	5.6	68	5.7	43	16.7	52	18.6	36	20.5	48	9.8	51	5.8	39
◆ R 2000(R)	4.7	47	9.2	31	3.4	66	18.0	45	18.4	38	24.1	23	14.8	25	6.4	35
MEDIAN	4.5		7.2		5.1		17.1		16.6		20.3		10.0		2.7	

VERMONT MUNICIPAL EMPLOYEES

EQUITY ONLY - RATES OF RETURN

PERIODS ENDING 9/05

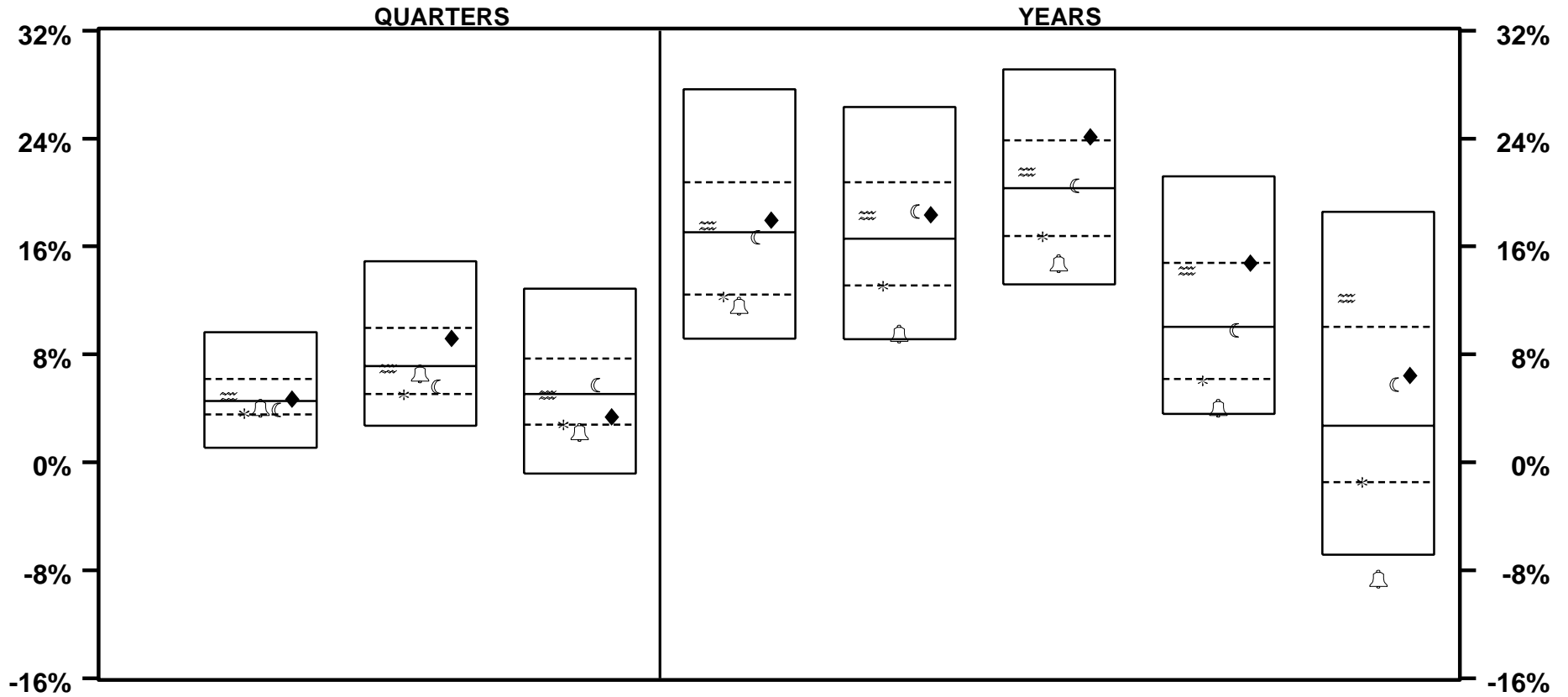

	LAST QTR		LAST 2 QTRS		LAST 3 QTRS		LAST YEAR		LAST 2 YEARS		LAST 3 YEARS		LAST 4 YEARS		LAST 5 YEARS	
≈ LAZARD	4.9	43	7.0	51	5.0	50	17.5	47	18.3	38	21.5	40	14.2	27	12.2	19
* S&P 500	3.6	71	5.0	77	2.8	77	12.3	81	13.1	77	16.7	79	6.0	82	-1.5	77
🔔 R 1000(R) GR	4.0	59	6.6	54	2.2	84	11.6	87	9.5	93	14.7	89	4.0	93	-8.6	97
☾ R 1000(R) VALUE	3.9	61	5.6	68	5.7	43	16.7	52	18.6	36	20.5	48	9.8	51	5.8	39
◆ R 2000(R)	4.7	47	9.2	31	3.4	66	18.0	45	18.4	38	24.1	23	14.8	25	6.4	35
MEDIAN	4.5		7.2		5.1		17.1		16.6		20.3		10.0		2.7	

VERMONT MUNICIPAL EMPLOYEES

EQUITY ONLY - RATES OF RETURN

PERIODS ENDING 9/05

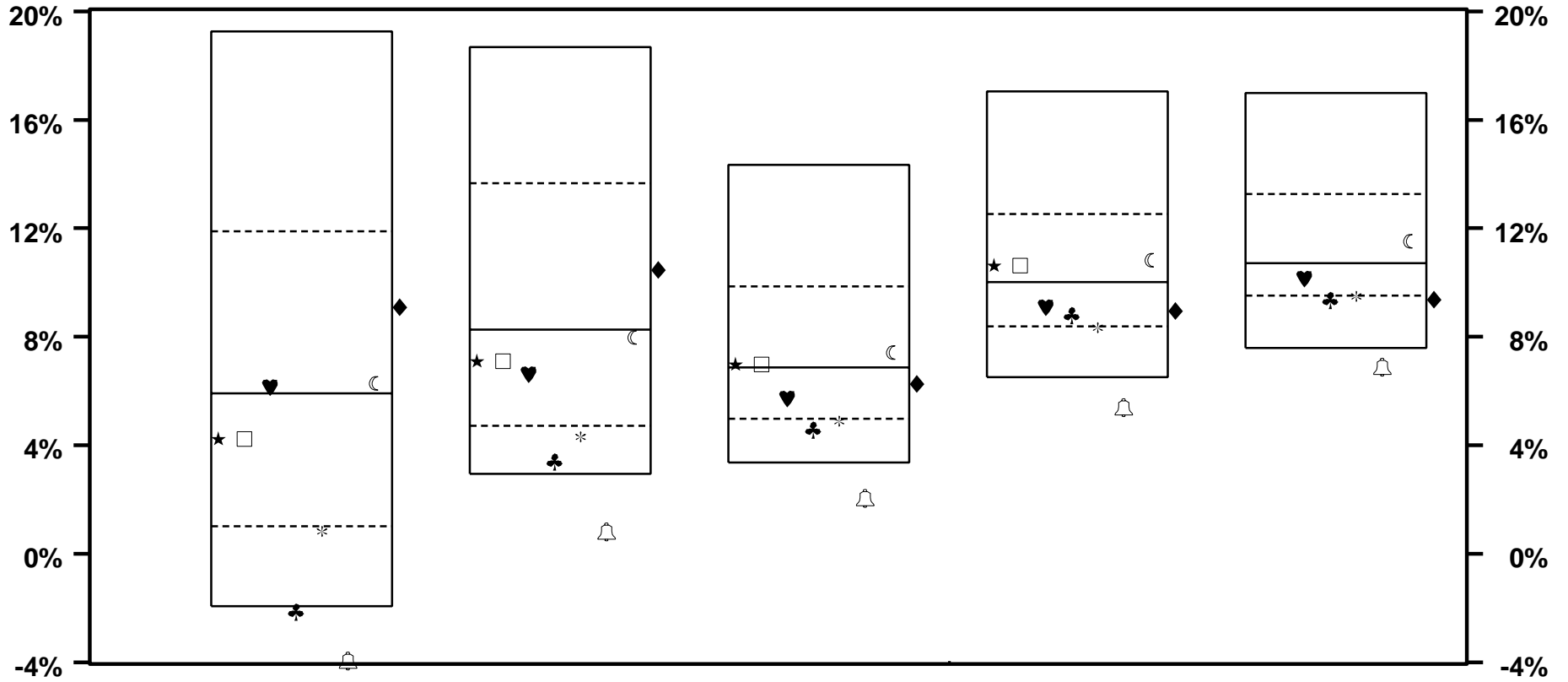

	LAST 6 YEARS		LAST 7 YEARS		LAST 8 YEARS		LAST 9 YEARS		LAST 10 YEARS	
★ MUNI COMPOSITE	4.2	59	7.1	59	7.0	48	10.6	42		
□ EQTY COMPOSITE	4.2	59	7.1	59	7.0	48	10.6	42		
♥ DELAWARE	6.1	48	6.6	63	5.7	63	9.1	60	10.1	60
♣ ALLIANCE	-2.1	95	3.4	93	4.6	86	8.8	63	9.4	83
* S&P 500	0.8	83	4.3	85	4.9	80	8.3	78	9.5	77
🔔 R 1000(R) GR	-3.9	98	0.8	99	2.1	97	5.4	97	6.9	98
☾ R 1000(R) VALUE	6.3	47	8.0	53	7.4	43	10.8	40	11.5	41
◆ R 2000(R)	9.1	35	10.5	38	6.3	56	9.0	62	9.4	82
MEDIAN	5.9		8.3		6.9		10.0		10.7	

VERMONT MUNICIPAL EMPLOYEES

EQUITY ONLY - RATES OF RETURN

PERIODS ENDING 9/05

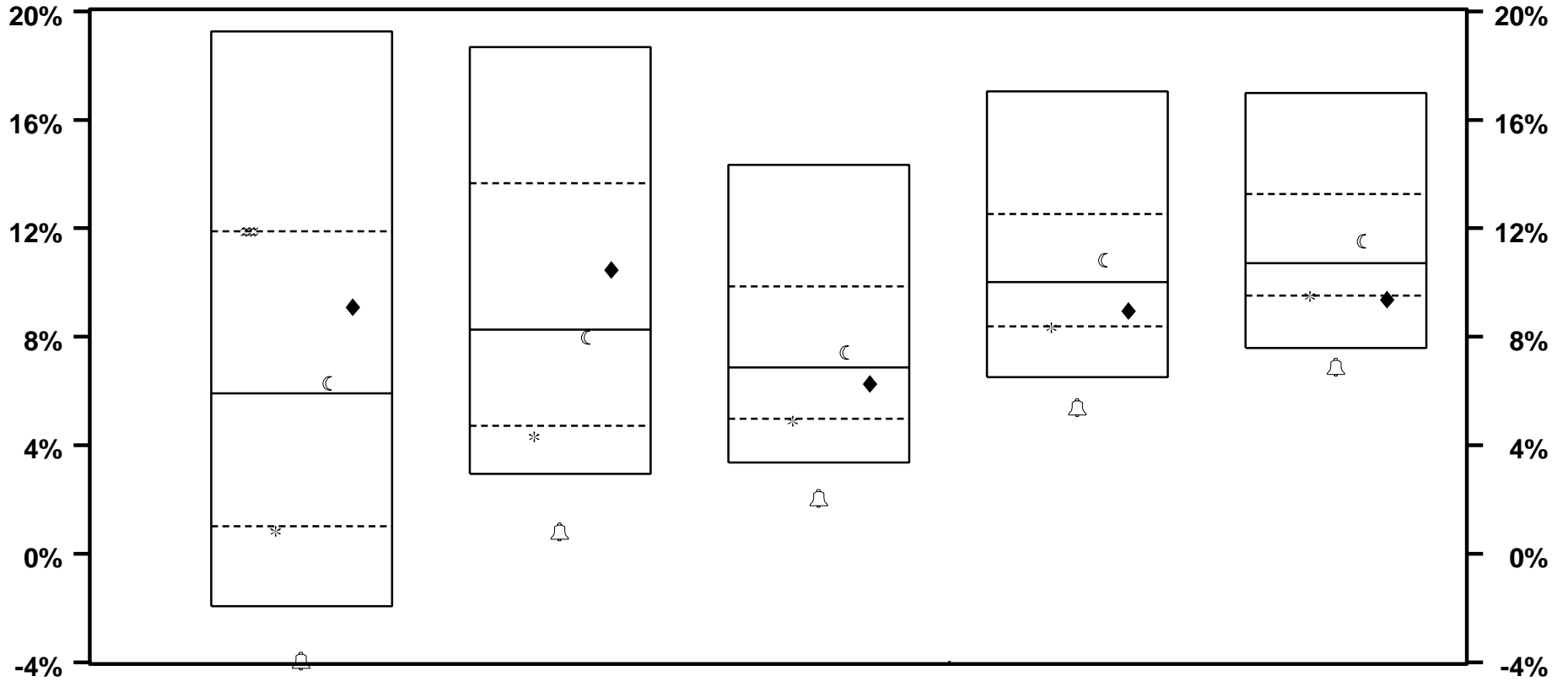

	LAST 6 YEARS		LAST 7 YEARS		LAST 8 YEARS		LAST 9 YEARS		LAST 10 YEARS	
≈ LAZARD	11.9	25								
* S&P 500	0.8	83	4.3	85	4.9	80	8.3	78	9.5	77
🔔 R 1000(R) GR	-3.9	98	0.8	99	2.1	97	5.4	97	6.9	98
☾ R 1000(R) VALUE	6.3	47	8.0	53	7.4	43	10.8	40	11.5	41
◆ R 2000(R)	9.1	35	10.5	38	6.3	56	9.0	62	9.4	82
MEDIAN	5.9		8.3		6.9		10.0		10.7	

VERMONT MUNICIPAL EMPLOYEES

EQUITY ONLY - RATES OF RETURN

YEARS ENDING

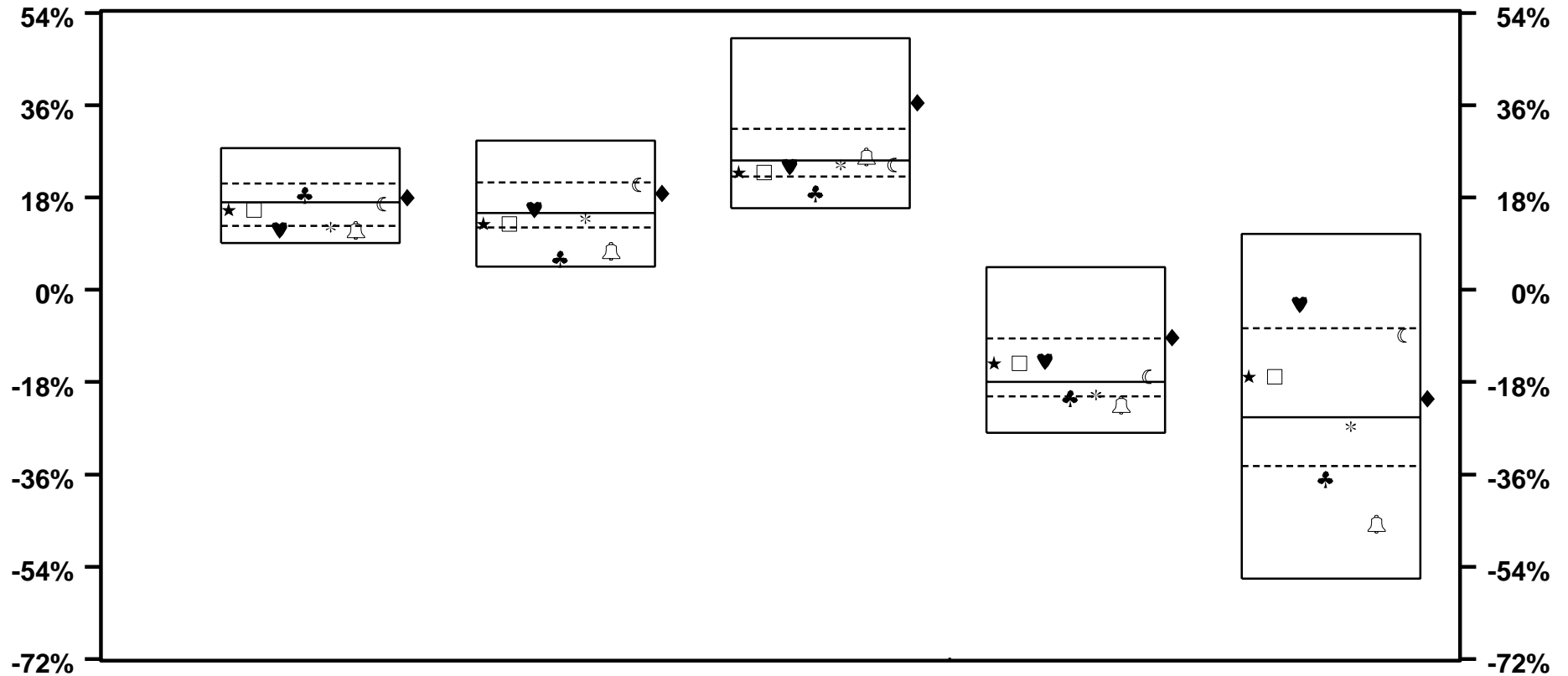

	9 / 05		9 / 04		9 / 03		9 / 02		9 / 01	
★ MUNI COMPOSITE	15.6	58	12.9	70	22.9	70	-14.3	37	-16.9	38
□ EQTY COMPOSITE	15.6	58	12.9	70	22.9	70	-14.3	37	-16.9	38
♥ DELAWARE	11.7	87	15.7	46	24.0	65	-13.9	36	-2.8	19
♣ ALLIANCE	18.5	41	6.1	93	18.8	88	-21.1	76	-36.9	78
* S&P 500	12.3	81	13.9	61	24.4	59	-20.5	70	-26.6	59
🔔 R 1000(R) GR	11.6	87	7.5	89	25.9	45	-22.5	84	-45.6	87
☾ R 1000(R) VALUE	16.7	52	20.5	26	24.4	61	-17.0	46	-8.9	27
◆ R 2000(R)	18.0	45	18.8	33	36.5	13	-9.3	24	-21.2	44
MEDIAN	17.1		15.0		25.3		-18.0		-24.8	

VERMONT MUNICIPAL EMPLOYEES

EQUITY ONLY - RATES OF RETURN

YEARS ENDING

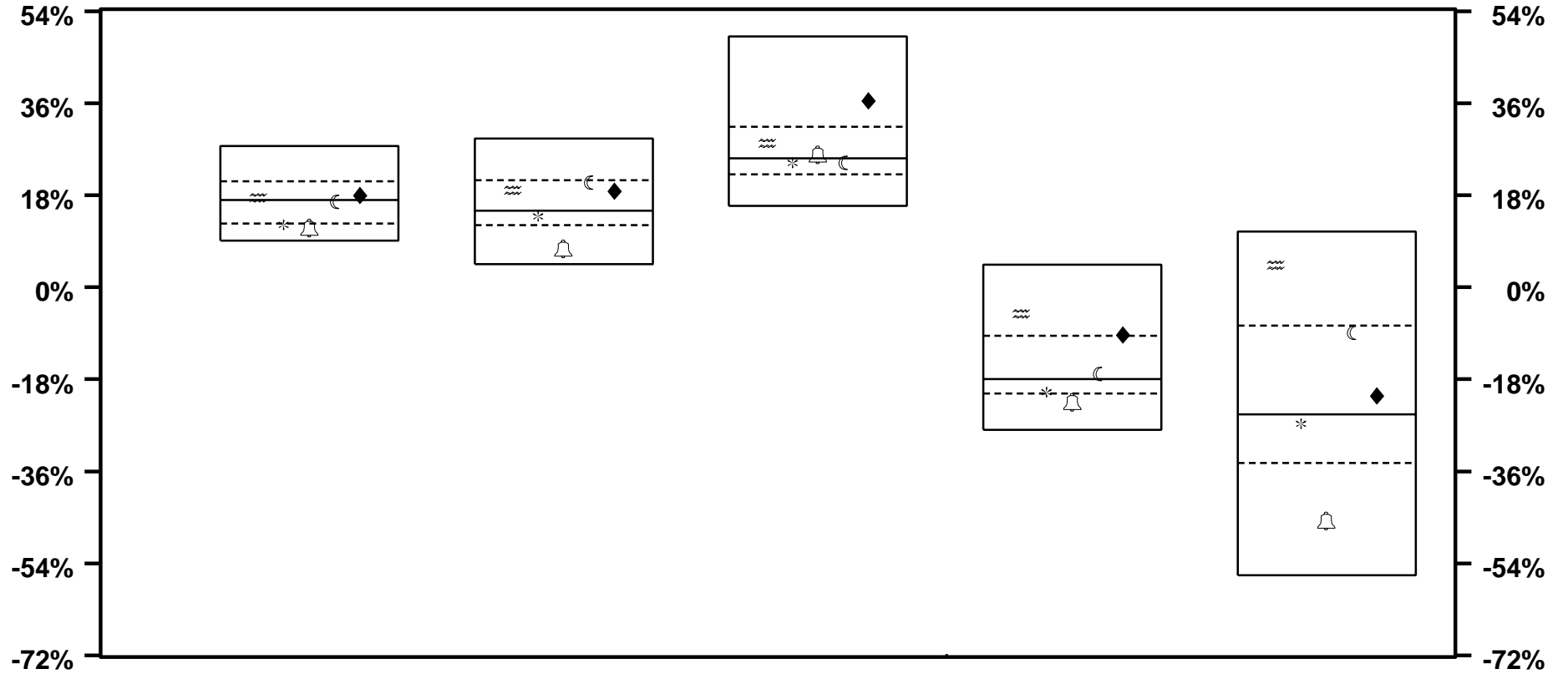

	9 / 05		9 / 04		9 / 03		9 / 02		9 / 01	
≈ LAZARD	17.5	47	19.1	32	28.2	33	-5.2	16	4.4	11
* S&P 500	12.3	81	13.9	61	24.4	59	-20.5	70	-26.6	59
🔔 R 1000(R) GR	11.6	87	7.5	89	25.9	45	-22.5	84	-45.6	87
Ⓒ R 1000(R) VALUE	16.7	52	20.5	26	24.4	61	-17.0	46	-8.9	27
◆ R 2000(R)	18.0	45	18.8	33	36.5	13	-9.3	24	-21.2	44
MEDIAN	17.1		15.0		25.3		-18.0		-24.8	

VERMONT MUNICIPAL EMPLOYEES

EQUITY ONLY - RATES OF RETURN

YEARS ENDING

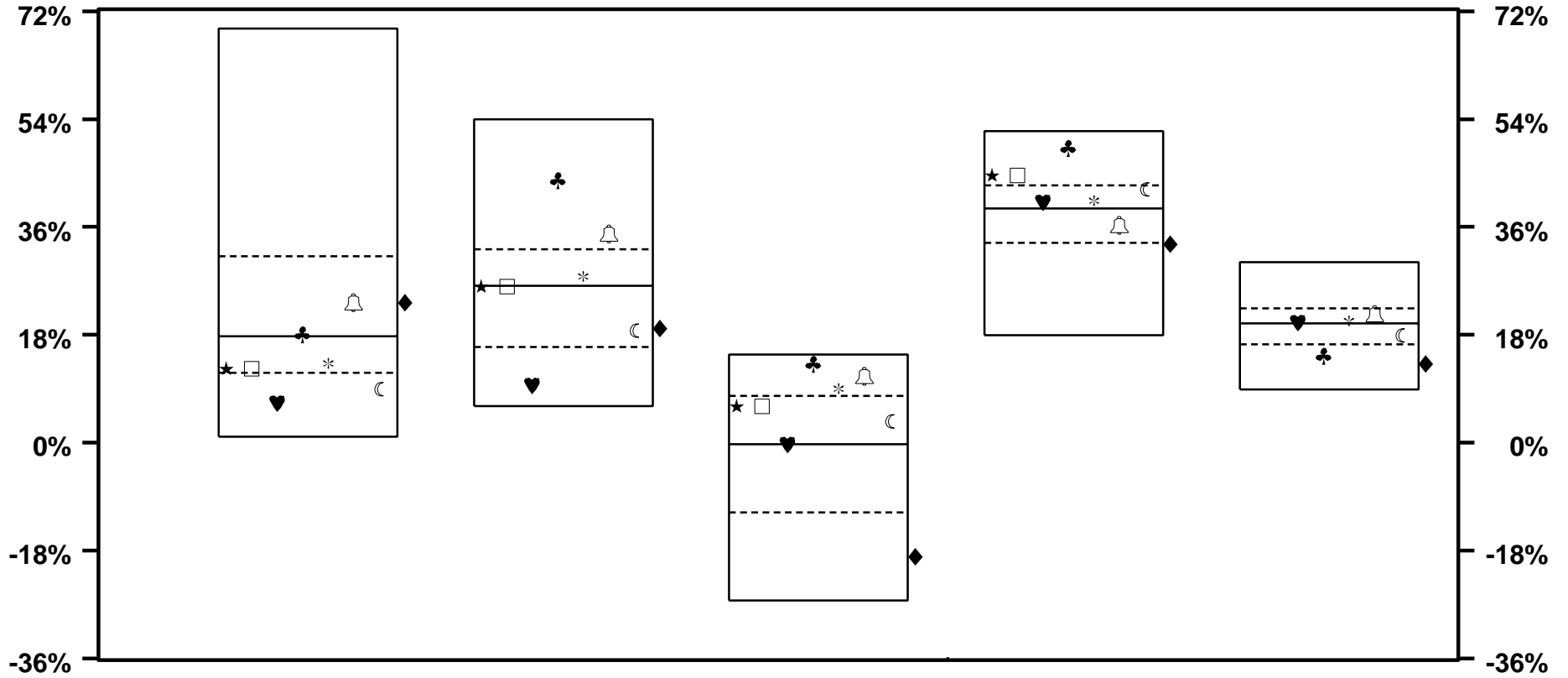

	9 / 00		9 / 99		9 / 98		9 / 97		9 / 96	
★ MUNI COMPOSITE	12.3	73	26.1	50	6.1	28	44.6	19		
□ EQTY COMPOSITE	12.3	73	26.1	50	6.1	28	44.6	19		
♥ DELAWARE	6.6	86	9.6	89	-0.3	50	40.1	43	20.1	49
♣ ALLIANCE	18.1	48	43.8	10	13.2	6	49.2	8	14.5	84
* S&P 500	13.3	66	27.8	40	9.0	19	40.4	39	20.3	43
🔔 R 1000(R) GR	23.4	37	34.9	20	11.1	10	36.3	62	21.4	31
☾ R 1000(R) VALUE	8.9	81	18.7	68	3.6	35	42.3	27	17.9	64
◆ R 2000(R)	23.4	37	19.1	68	-19.0	86	33.2	75	13.1	87
MEDIAN	17.8		26.1		-0.2		39.1		19.9	

VERMONT MUNICIPAL EMPLOYEES

EQUITY ONLY - RATES OF RETURN

YEARS ENDING

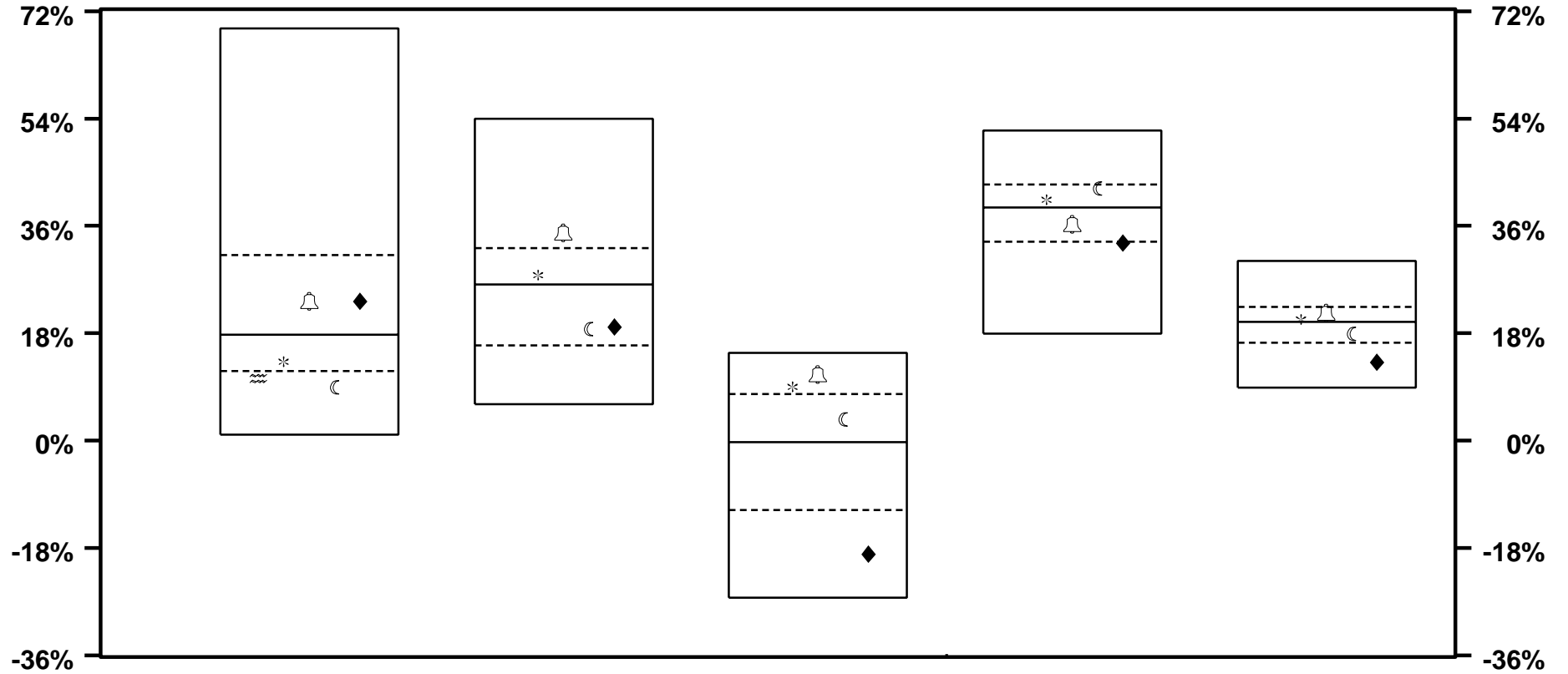

	9 / 00		9 / 99		9 / 98		9 / 97		9 / 96	
≈ LAZARD	10.4	77								
* S&P 500	13.3	66	27.8	40	9.0	19	40.4	39	20.3	43
🔔 R 1000(R) GR	23.4	37	34.9	20	11.1	10	36.3	62	21.4	31
☾ R 1000(R) VALUE	8.9	81	18.7	68	3.6	35	42.3	27	17.9	64
◆ R 2000(R)	23.4	37	19.1	68	-19.0	86	33.2	75	13.1	87
MEDIAN	17.8		26.1		-0.2		39.1		19.9	

VERMONT MUNICIPAL EMPLOYEES

EQUITY ONLY - ACTIVELY MANAGED - PURCHASES & SALES TURNOVER

PERIODS ENDING 9/05

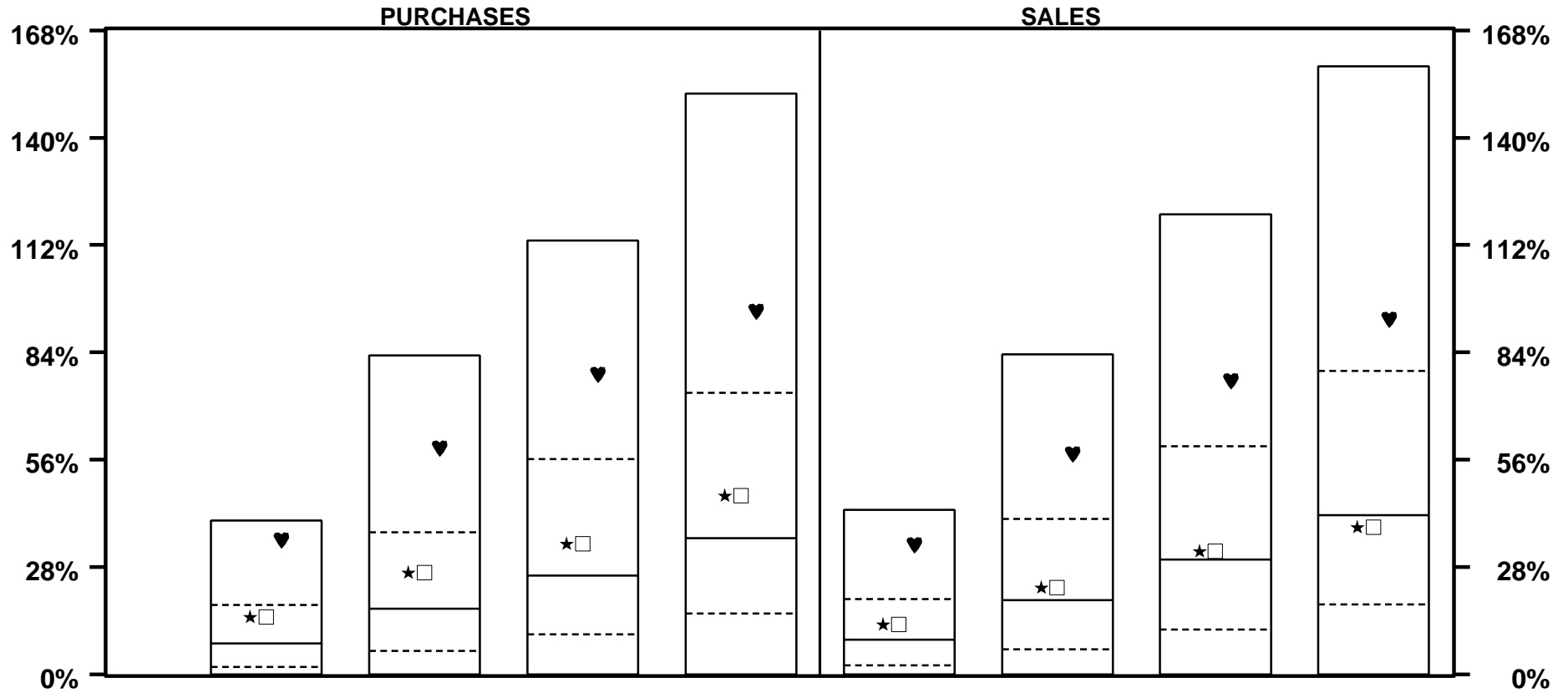

	LAST QTR		LAST 2 QTRS		LAST 3 QTRS		LAST YEAR		LAST QTR		LAST 2 QTRS		LAST 3 QTRS		LAST YEAR	
★ MUNI COMPOSITE	15.0	30	26.6	35	34.2	41	46.6	41	13.1	38	22.7	45	32.1	48	38.4	52
□ EQTY COMPOSITE	15.0	30	26.6	35	34.2	41	46.6	41	13.1	38	22.7	45	32.1	48	38.4	52
♥ DELAWARE	35.1	7	59.1	10	78.3	12	94.7	16	33.9	9	57.5	12	76.7	15	92.6	18
MEDIAN	8.1		17.1		25.8		35.5		9.0		19.3		30.0		41.6	

VERMONT MUNICIPAL EMPLOYEES

EQUITY ONLY - BUY & HOLD VS ACTUAL RETURNS

PERIODS ENDING 9/05

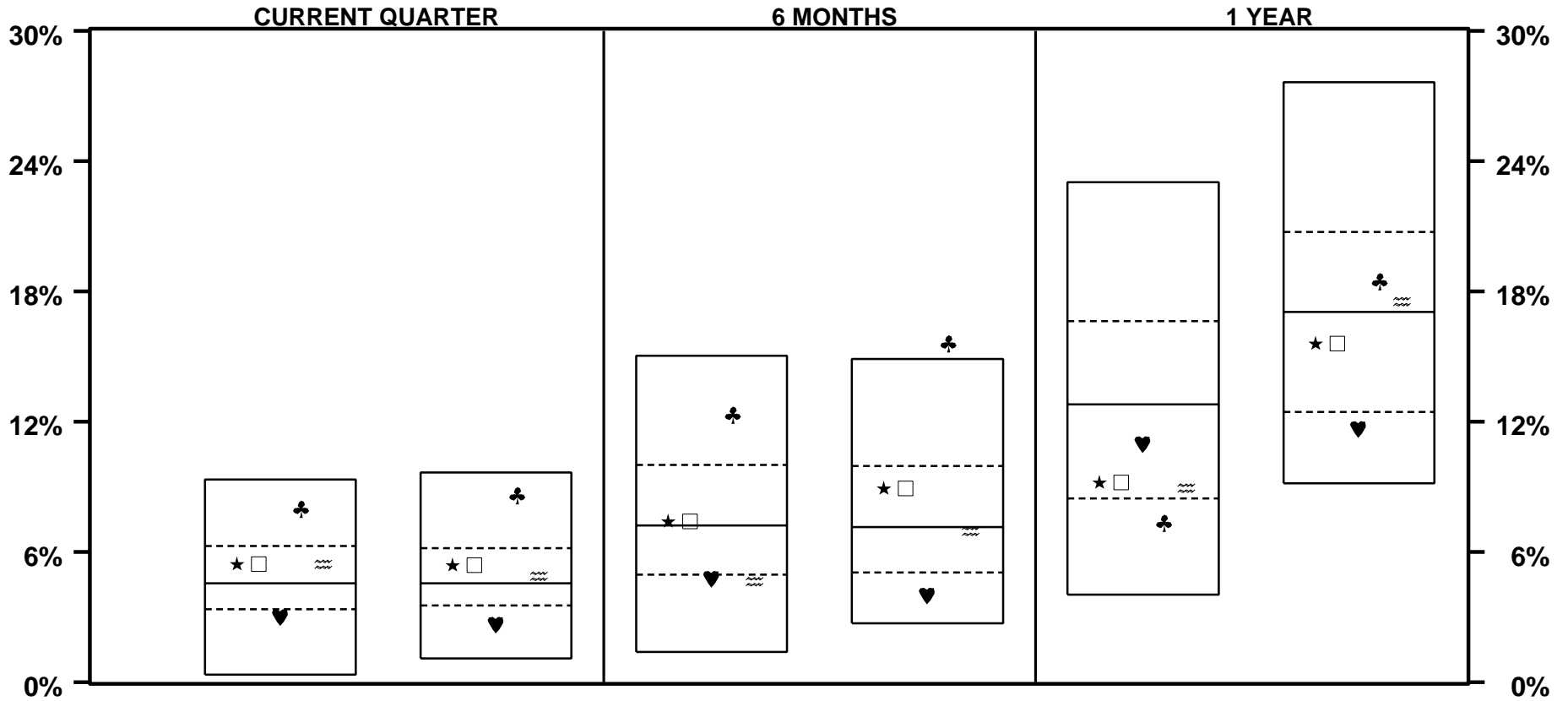

	BUY & HOLD		EQUITY ONLY		BUY & HOLD		EQUITY ONLY		BUY & HOLD		EQUITY ONLY	
★ MUNI COMPOSITE	5.4	36	5.4	36	7.4	48	8.9	33	9.2	70	15.6	58
□ EQTY COMPOSITE	5.4	36	5.4	36	7.4	48	8.9	33	9.2	70	15.6	58
♥ DELAWARE	3.0	79	2.7	86	4.8	80	4.0	88	11.0	60	11.7	87
♣ ALLIANCE	8.0	11	8.6	7	12.3	10	15.6	3	7.3	85	18.5	41
≈ LAZARD	5.4	36	4.9	43	4.6	81	7.0	51	9.0	71	17.5	47
MEDIAN	4.6		4.5		7.2		7.2		12.8		17.1	

VERMONT MUNICIPAL EMPLOYEES

EQUITY ONLY RETURNS VS RISK

3 YEARS ENDING 9/05

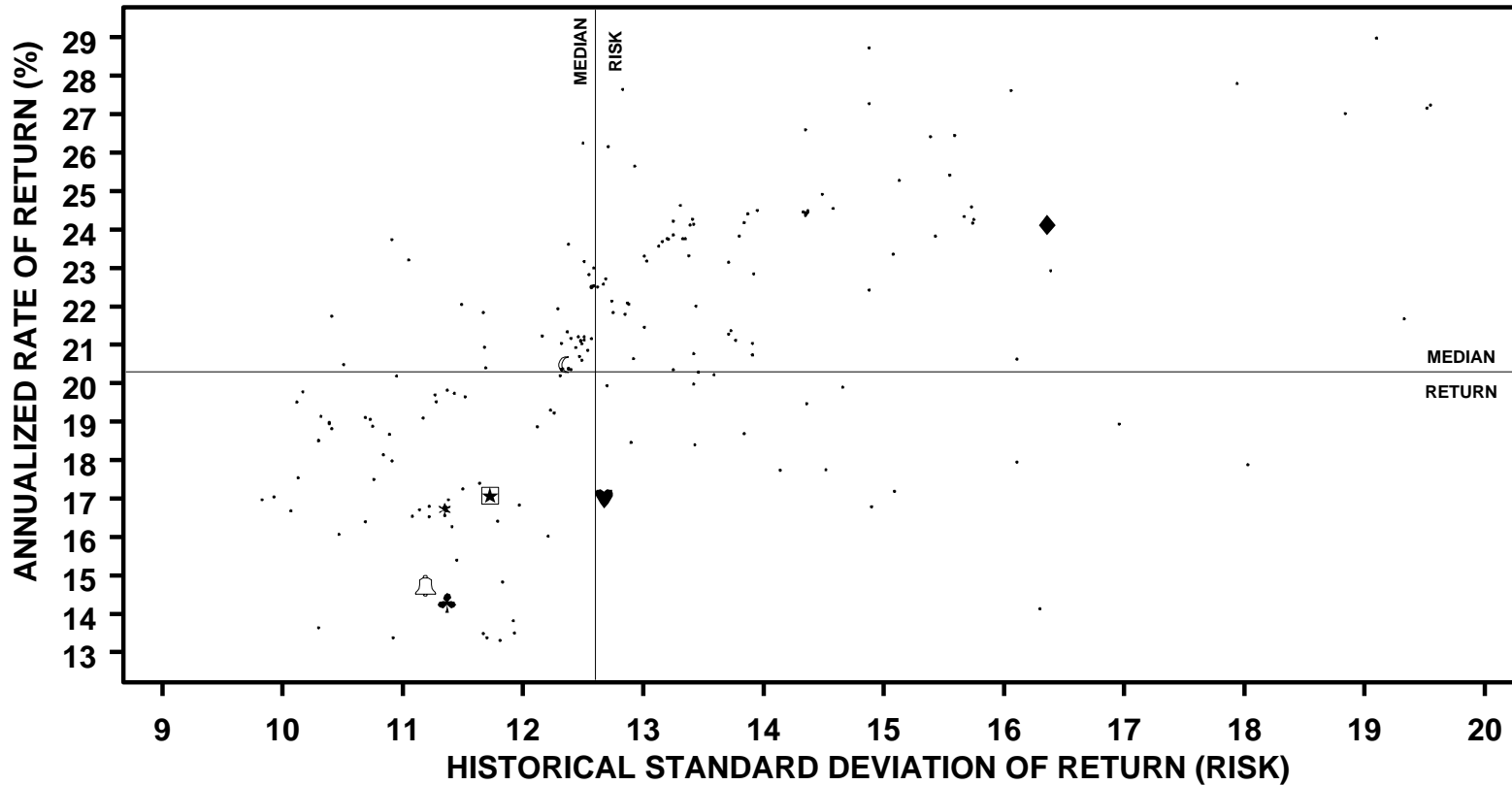

	ANNUALIZED RETURN		STANDARD DEVIATION		SHARPE RATIO	
	VALUE	RANK	VALUE	RANK	VALUE	RANK
★ MUNI COMPOSITE	17.1	70	11.7	65	1.3	68
□ EQTY COMPOSITE	17.1	70	11.7	65	1.3	68
♥ DELAWARE	17.0	71	12.7	47	1.2	79
♣ ALLIANCE	14.3	90	11.4	72	1.1	87
* S&P 500	16.7	79	11.4	74	1.3	63
🔔 R 1000(R) GR	14.7	89	11.2	81	1.2	83
☾ R 1000(R) VALUE	20.5	48	12.3	56	1.5	33
◆ R 2000(R)	24.1	23	16.4	15	1.3	54
MEDIAN	20.3		12.6		1.4	

VERMONT MUNICIPAL EMPLOYEES

EQUITY ONLY RETURNS VS RISK

3 YEARS ENDING 9/05

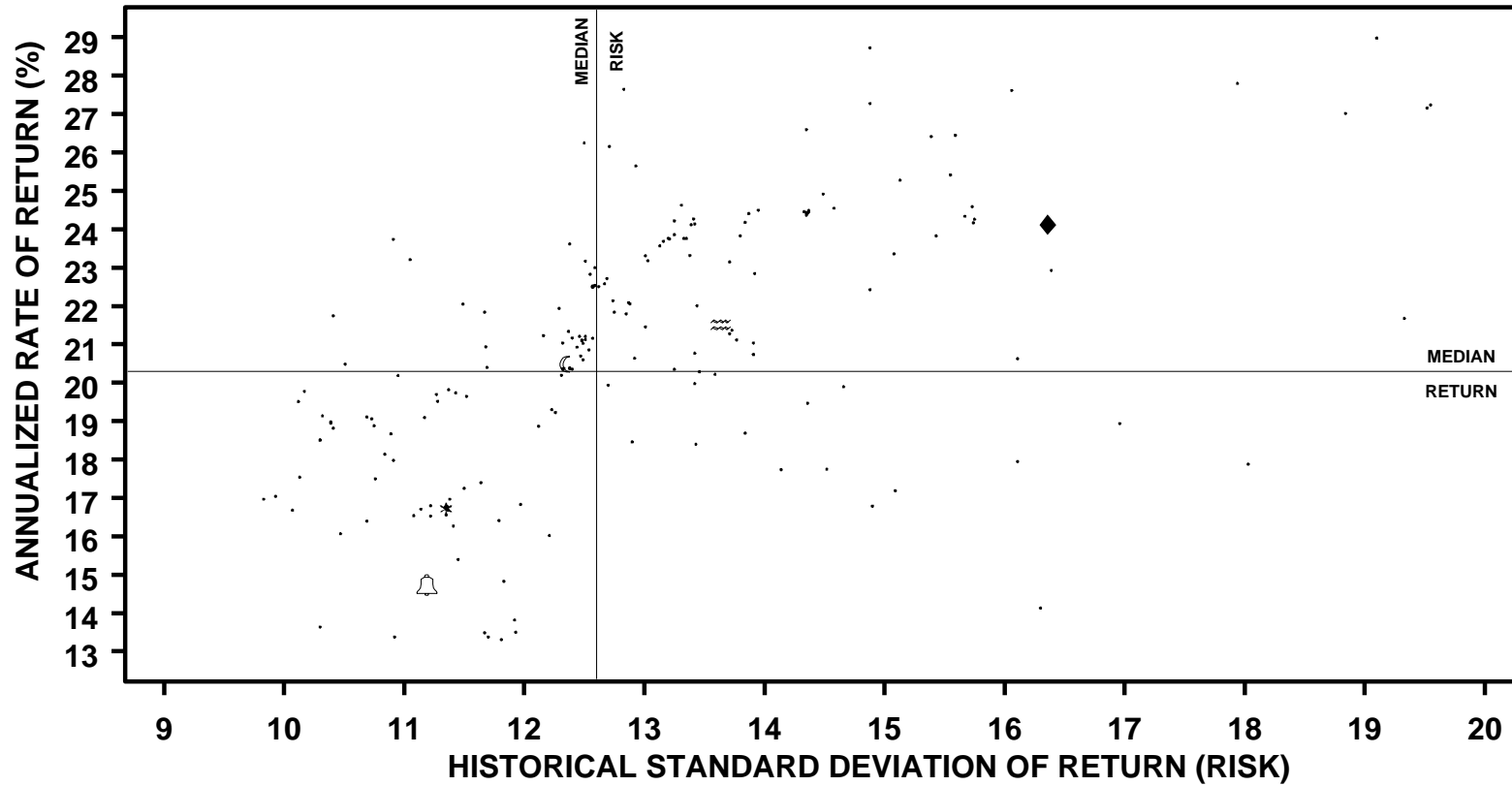

	ANNUALIZED RETURN		STANDARD DEVIATION		SHARPE RATIO	
	VALUE	RANK	VALUE	RANK	VALUE	RANK
≈ LAZARD	21.5	40	13.6	36	1.4	41
* S&P 500	16.7	79	11.4	74	1.3	63
🔔 R 1000(R) GR	14.7	89	11.2	81	1.2	83
☾ R 1000(R) VALUE	20.5	48	12.3	56	1.5	33
◆ R 2000(R)	24.1	23	16.4	15	1.3	54
MEDIAN	20.3		12.6		1.4	

VERMONT MUNICIPAL EMPLOYEES

EQUITY ONLY RETURNS VS RISK

5 YEARS ENDING 9/05

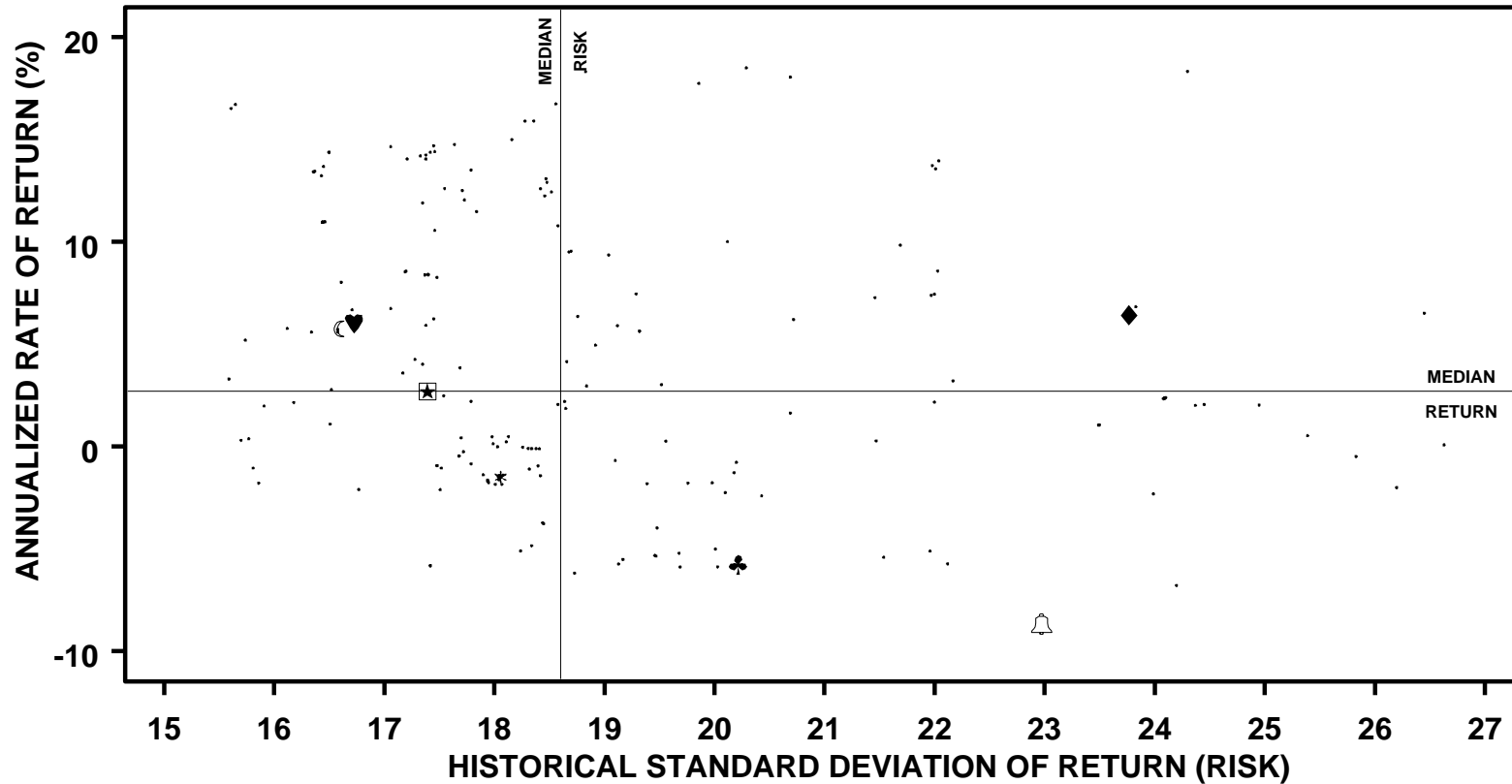

	ANNUALIZED RETURN		STANDARD DEVIATION		SHARPE RATIO	
	VALUE	RANK	VALUE	RANK	VALUE	RANK
★ MUNI COMPOSITE	2.7	50	17.4	76	0.1	52
□ EQTY COMPOSITE	2.7	50	17.4	76	0.1	52
♥ DELAWARE	6.1	37	16.7	83	0.3	36
♣ ALLIANCE	-5.8	92	20.2	34	-0.3	
* S&P 500	-1.5	77	18.1	59	-0.1	
🔔 R 1000(R) GR	-8.6	97	23.0	20	-0.4	
☾ R 1000(R) VALUE	5.8	39	16.6	84	0.3	38
◆ R 2000(R)	6.4	35	23.8	18	0.3	37
MEDIAN	2.7		18.6		0.1	

VERMONT MUNICIPAL EMPLOYEES

EQUITY ONLY RETURNS VS RISK

5 YEARS ENDING 9/05

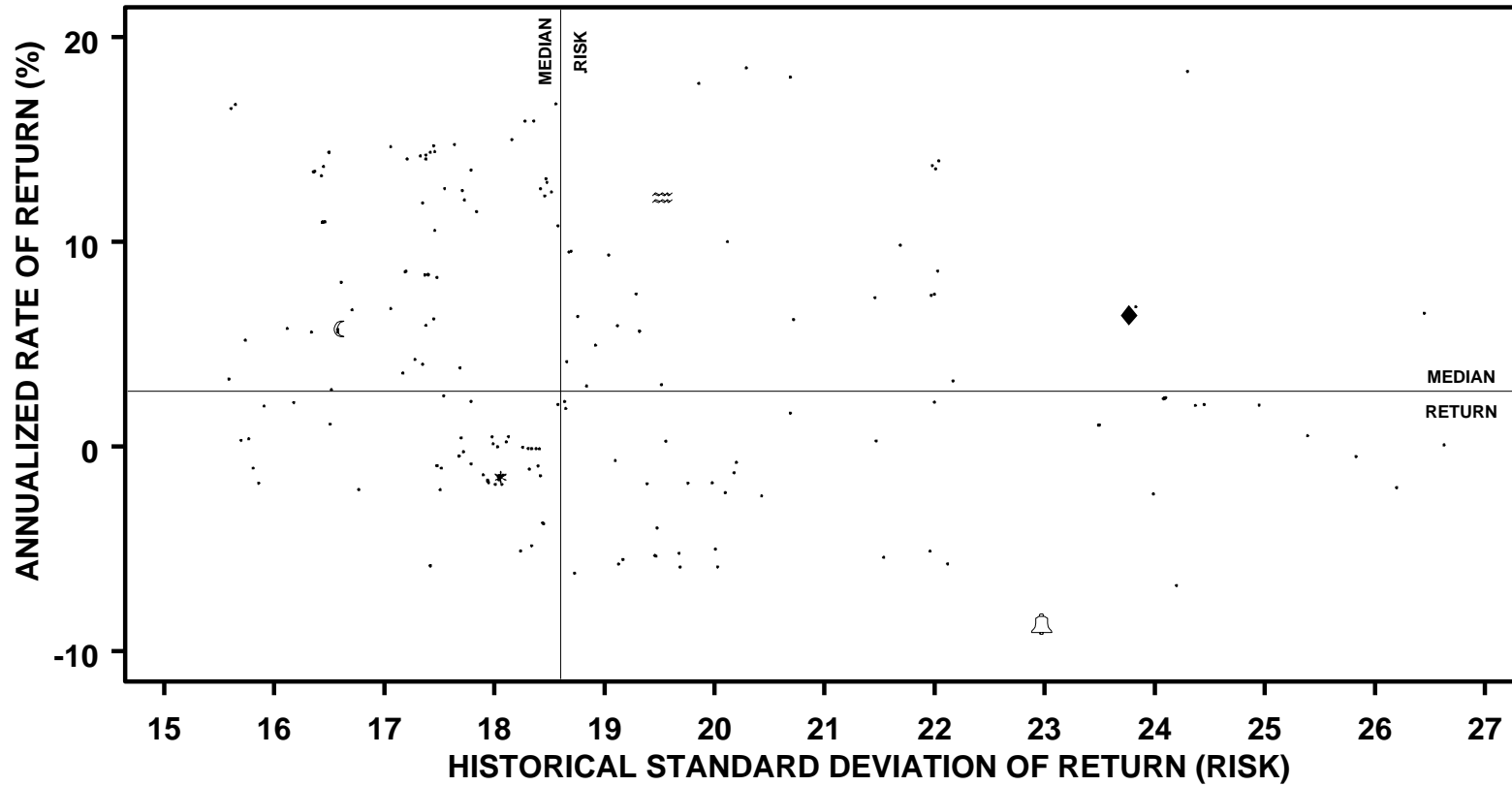

	ANNUALIZED RETURN		STANDARD DEVIATION		SHARPE RATIO	
	VALUE	RANK	VALUE	RANK	VALUE	RANK
≈ LAZARD	12.2	19	19.5	40	0.6	20
* S&P 500	-1.5	77	18.1	59	-0.1	
🔔 R 1000(R) GR	-8.6	97	23.0	20	-0.4	
☾ R 1000(R) VALUE	5.8	39	16.6	84	0.3	38
◆ R 2000(R)	6.4	35	23.8	18	0.3	37
MEDIAN	2.7		18.6		0.1	

VERMONT MUNICIPAL EMPLOYEES

COMBINED EQUITY FUNDS - TOTAL RATES OF RETURN

PERIODS ENDING 9/05

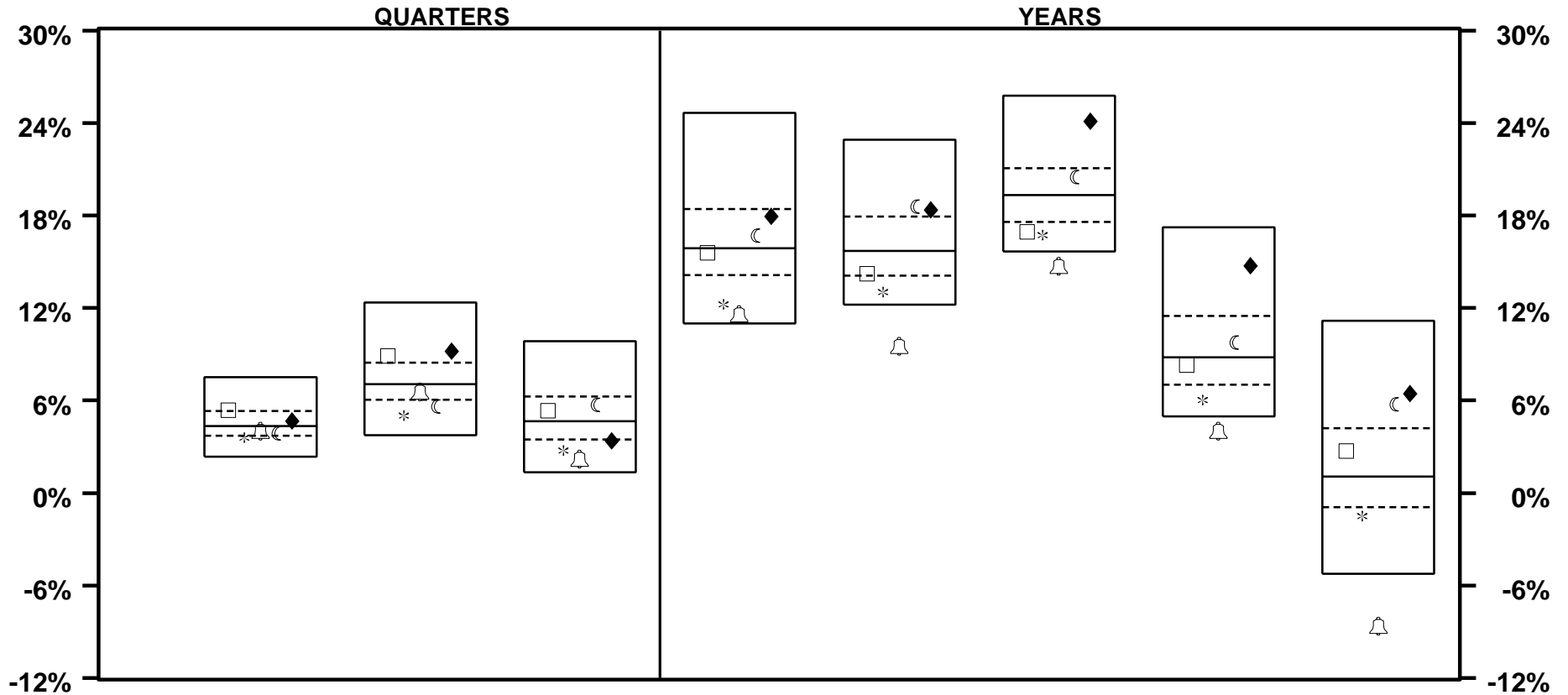

	LAST QTR		LAST 2 QTRS		LAST 3 QTRS		LAST YEAR		LAST 2 YEARS		LAST 3 YEARS		LAST 4 YEARS		LAST 5 YEARS	
□ EQTY COMPOSITE	5.4	22	8.9	20	5.4	37	15.6	54	14.2	72	17.0	80	8.3	56	2.7	34
* S&P 500	3.6	78	5.0	89	2.8	85	12.3	90	13.1	88	16.7	84	6.0	86	-1.5	82
🔔 R 1000(R) GR	4.0	64	6.6	58	2.2	90	11.6	94	9.5	98	14.7	96	4.0	97	-8.6	98
☾ R 1000(R) VALUE	3.9	68	5.6	81	5.7	33	16.7	39	18.6	19	20.5	31	9.8	41	5.8	19
◆ R 2000(R)	4.7	41	9.2	18	3.4	76	18.0	28	18.4	19	24.1	9	14.8	11	6.4	16
MEDIAN	4.4		7.0		4.6		15.9		15.7		19.3		8.8		1.1	

VERMONT MUNICIPAL EMPLOYEES

COMBINED EQUITY FUNDS - TOTAL RATES OF RETURN

PERIODS ENDING 9/05

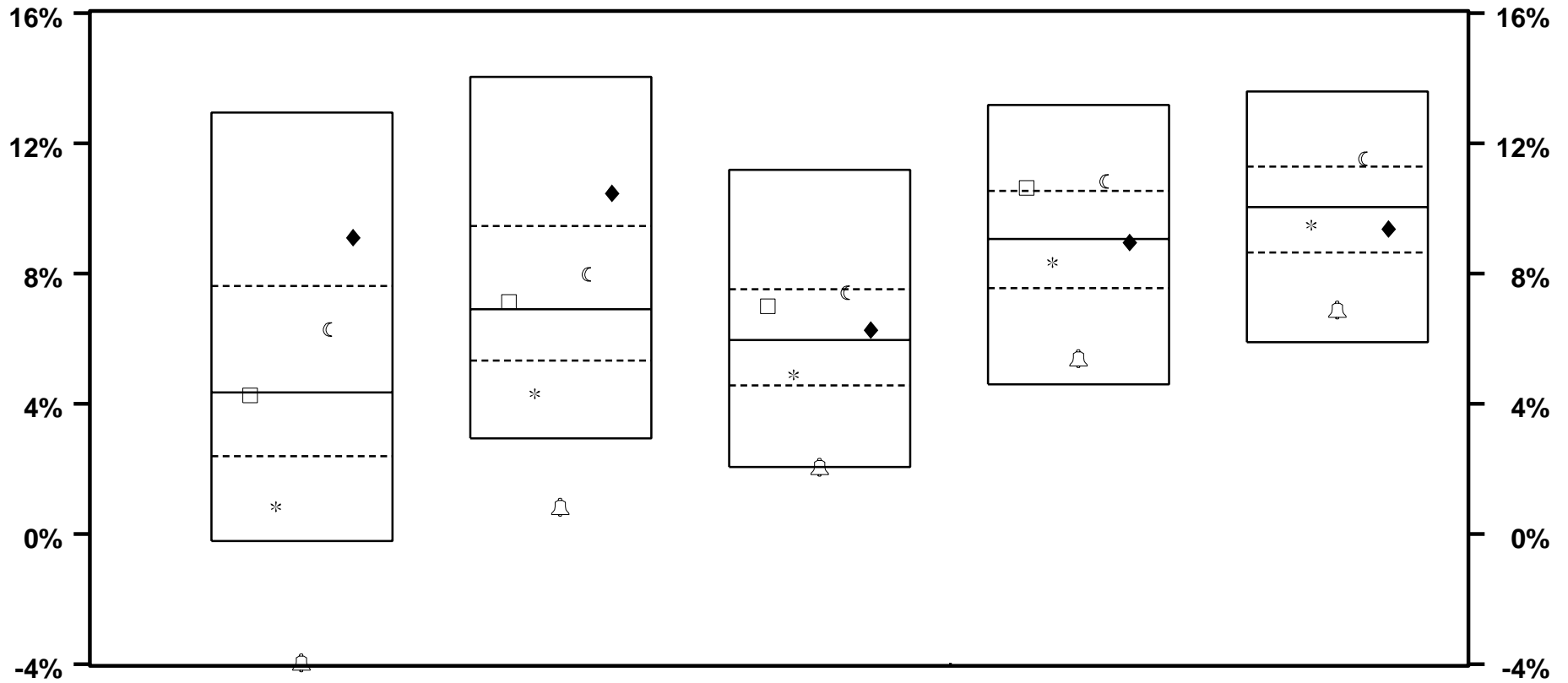

	LAST 6 YEARS		LAST 7 YEARS		LAST 8 YEARS		LAST 9 YEARS		LAST 10 YEARS	
□ EQTY COMPOSITE	4.3	51	7.1	48	7.0	32	10.6	22		
* S&P 500	0.8	90	4.3	87	4.9	69	8.3	62	9.5	61
🔔 R 1000(R) GR	-3.9	99	0.8	98	2.1	94	5.4	92	6.9	92
☾ R 1000(R) VALUE	6.3	32	8.0	38	7.4	26	10.8	20	11.5	24
◆ R 2000(R)	9.1	16	10.5	20	6.3	45	9.0	51	9.4	62
MEDIAN	4.3		6.9		6.0		9.1		10.0	

VERMONT MUNICIPAL EMPLOYEES COMBINED EQUITY FUNDS - TOTAL RATES OF RETURN YEARS ENDING

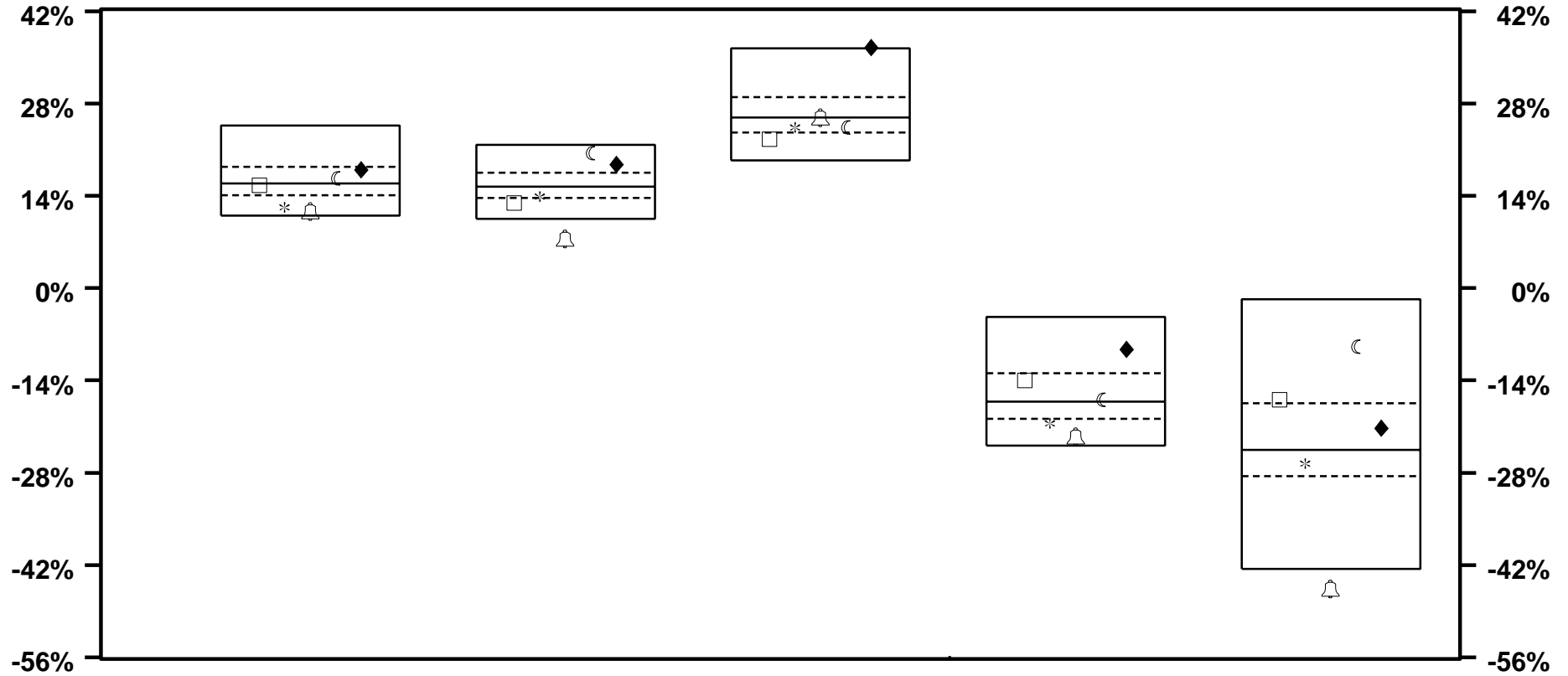

	9 / 05		9 / 04		9 / 03		9 / 02		9 / 01	
□ EQTY COMPOSITE	15.6	54	12.9	84	22.6	82	-14.0	30	-16.9	23
* S&P 500	12.3	90	13.9	71	24.4	66	-20.5	82	-26.6	63
🔔 R 1000(R) GR	11.6	94	7.5	98	25.9	49	-22.5	91	-45.6	97
☾ R 1000(R) VALUE	16.7	39	20.5	7	24.4	67	-17.0	48	-8.9	9
◆ R 2000(R)	18.0	28	18.8	16	36.5	4	-9.3	15	-21.2	35
MEDIAN	15.9		15.4		25.9		-17.2		-24.5	

VERMONT MUNICIPAL EMPLOYEES

COMBINED EQUITY FUNDS - TOTAL RATES OF RETURN

YEARS ENDING

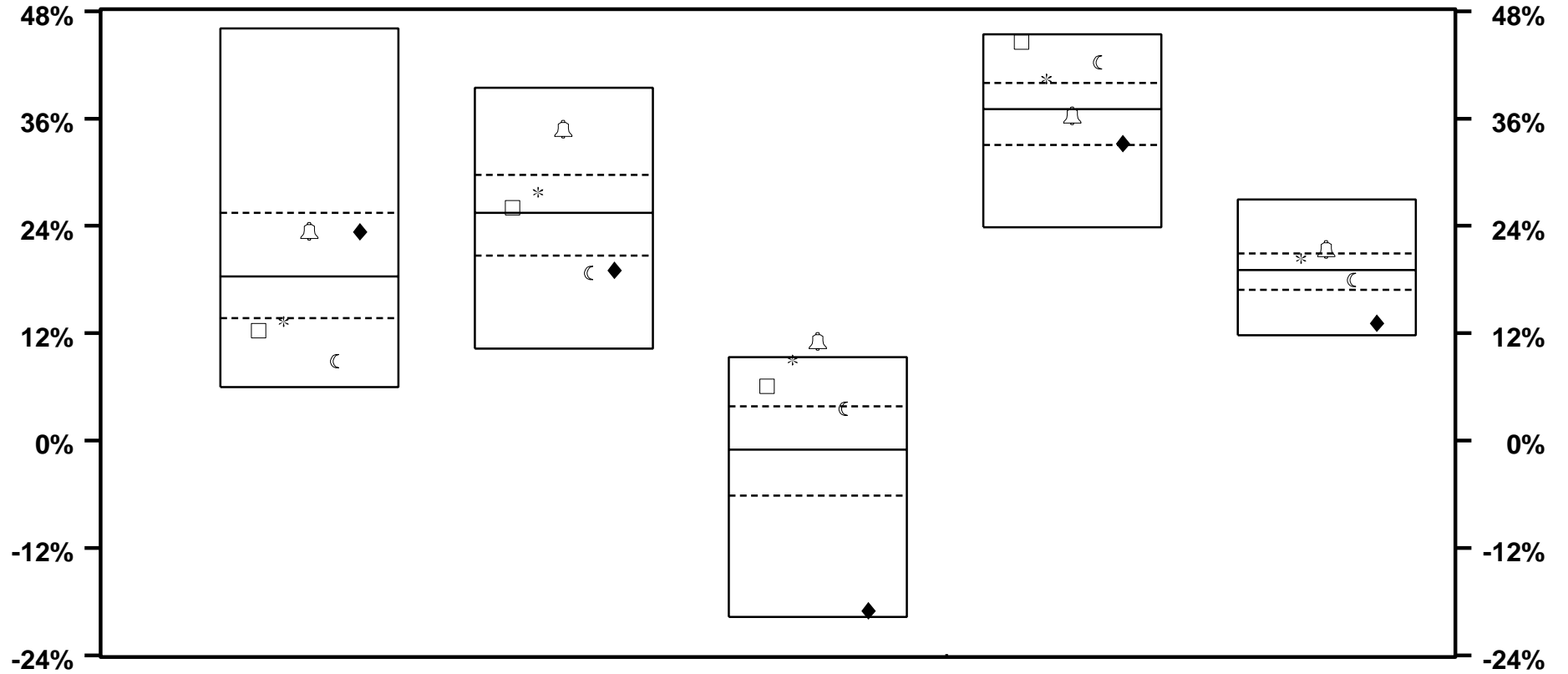

	9 / 00		9 / 99		9 / 98		9 / 97		9 / 96	
□ EQTY COMPOSITE	12.3	82	26.1	45	6.1	14	44.6	5		
* S&P 500	13.3	78	27.8	34	9.0	6	40.4	21	20.3	32
⌚ R 1000(R) GR	23.4	31	34.9	10	11.1	2	36.3	56	21.4	20
☾ R 1000(R) VALUE	8.9	91	18.7	80	3.6	26	42.3	9	17.9	64
◆ R 2000(R)	23.4	31	19.1	79	-19.0	93	33.2	74	13.1	92
MEDIAN	18.4		25.4		-1.0		37.0		19.1	

VERMONT MUNICIPAL EMPLOYEES

COMBINED EQUITY FUNDS - TOTAL RETURN VS RISK

3 YEARS ENDING 9/05

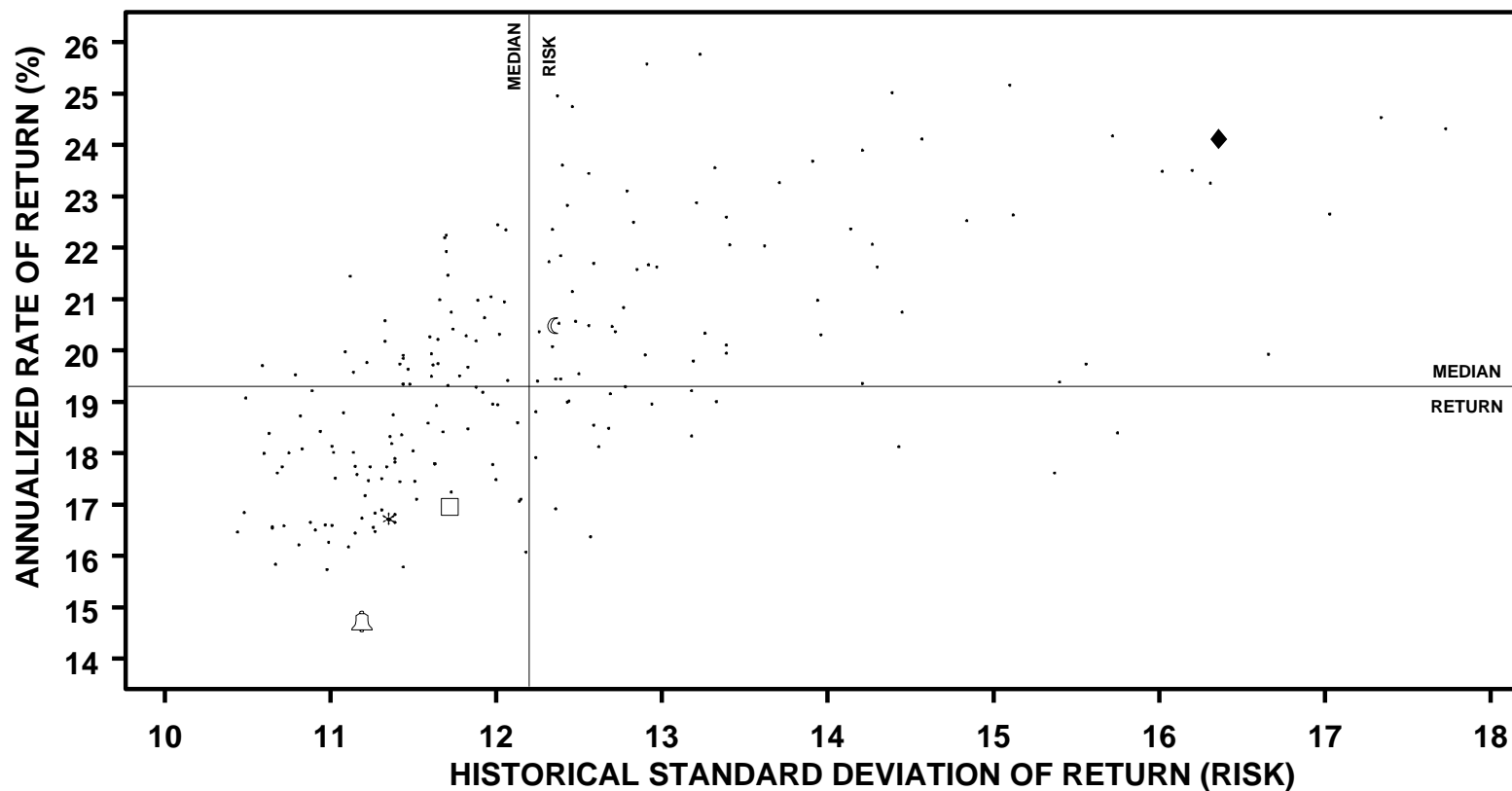

	ANNUALIZED RETURN		STANDARD DEVIATION		SHARPE RATIO	
	VALUE	RANK	VALUE	RANK	VALUE	RANK
□ EQTY COMPOSITE	17.0	80	11.7	62	1.3	81
* S&P 500	16.7	84	11.4	73	1.3	75
🔔 R 1000(R) GR	14.7	96	11.2	78	1.2	94
☾ R 1000(R) VALUE	20.5	31	12.3	46	1.5	29
◆ R 2000(R)	24.1	9	16.4	9	1.3	62
MEDIAN	19.3		12.2		1.4	

VERMONT MUNICIPAL EMPLOYEES

COMBINED EQUITY FUNDS - TOTAL RETURN VS RISK

5 YEARS ENDING 9/05

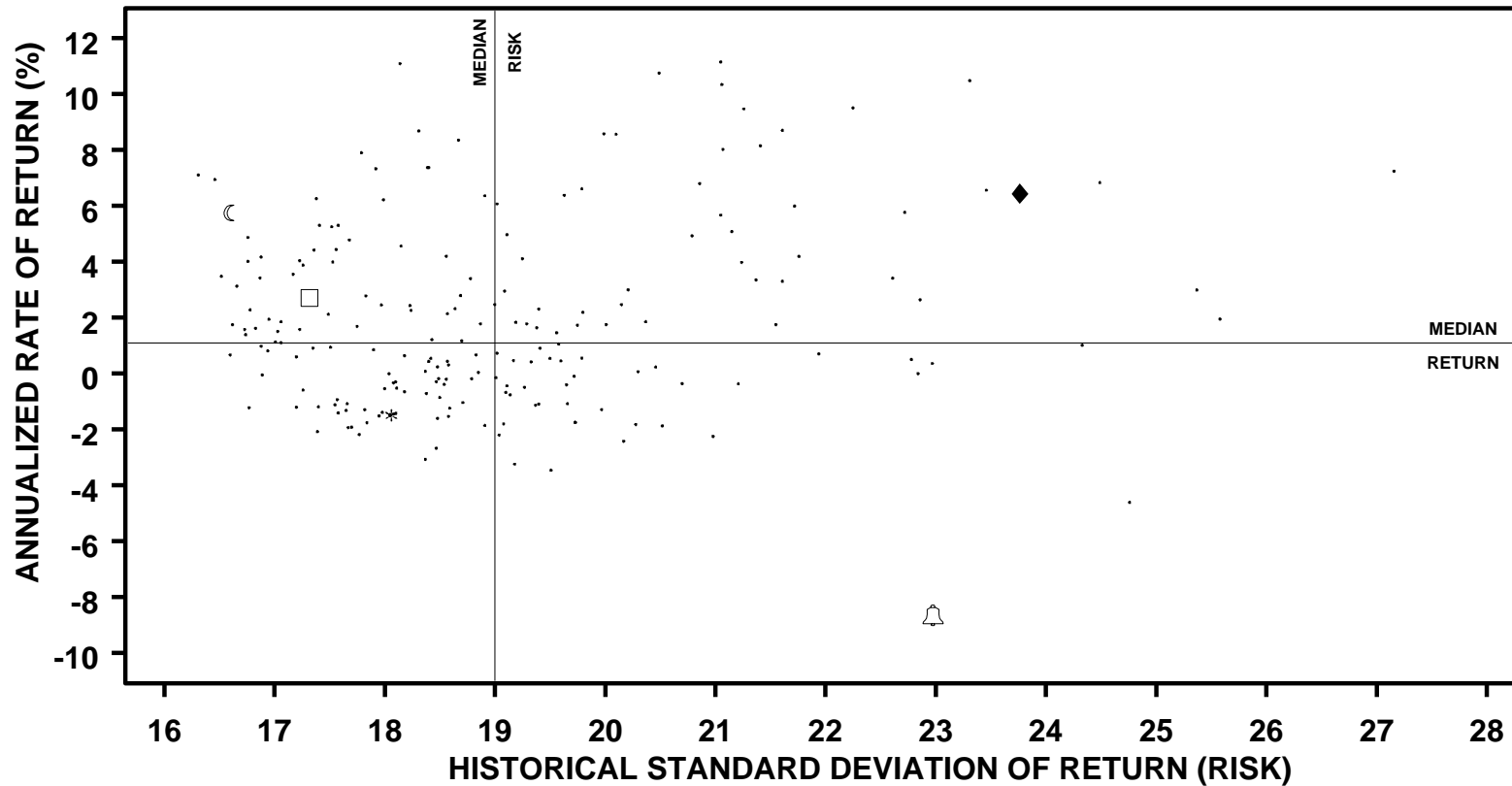

	ANNUALIZED RETURN		STANDARD DEVIATION		SHARPE RATIO	
	VALUE	RANK	VALUE	RANK	VALUE	RANK
□ EQTY COMPOSITE	2.7	34	17.3	84	0.1	35
* S&P 500	-1.5	82	18.1	69	-0.1	
🔔 R 1000(R) GR	-8.6	98	23.0	12	-0.4	
☾ R 1000(R) VALUE	5.8	19	16.6	93	0.3	18
◆ R 2000(R)	6.4	16	23.8	11	0.3	17
MEDIAN	1.1		19.0		0.0	

VERMONT MUNICIPAL EMPLOYEES

BOND FUNDS - TOTAL RATES OF RETURN

PERIODS ENDING 9/05

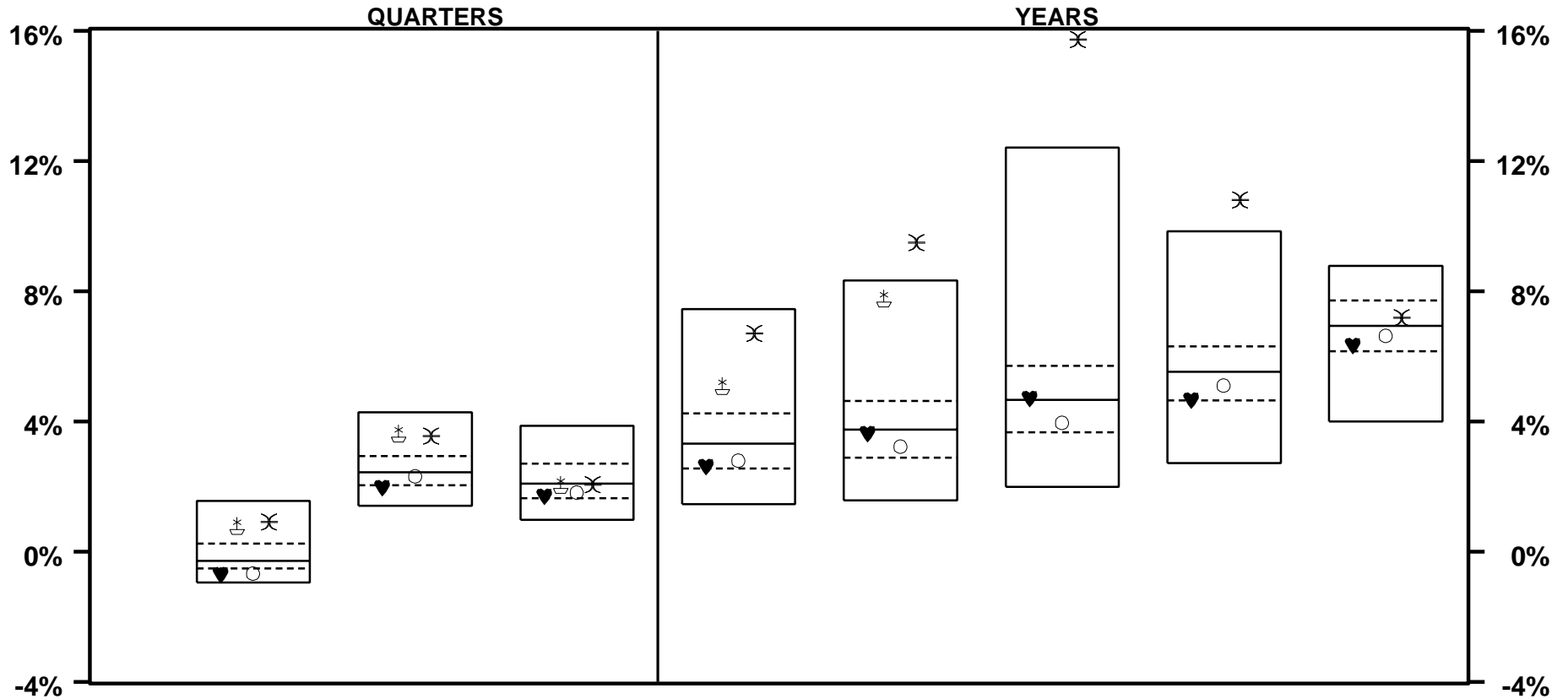

	LAST QTR		LAST 2 QTRS		LAST 3 QTRS		LAST YEAR		LAST 2 YEARS		LAST 3 YEARS		LAST 4 YEARS		LAST 5 YEARS	
♥ SEIX CORE	-0.7	89	2.0	77	1.7	72	2.6	73	3.6	52	4.7	49	4.7	74	6.3	70
⊕ SEIX HIGH YIELD	0.8	14	3.6	8	2.1	51	5.1	15	7.8	7						
○ LB AGGREGATE	-0.7	85	2.3	58	1.8	65	2.8	67	3.2	66	4.0	66	5.1	63	6.6	62
✕ ML HIGH YLD II	0.9	10	3.6	10	2.1	50	6.7	6	9.5	3	15.7	1	10.8	2	7.2	39
MEDIAN	-0.3		2.4		2.1		3.3		3.8		4.7		5.5		6.9	

VERMONT MUNICIPAL EMPLOYEES

BOND FUNDS - TOTAL RATES OF RETURN

YEARS ENDING

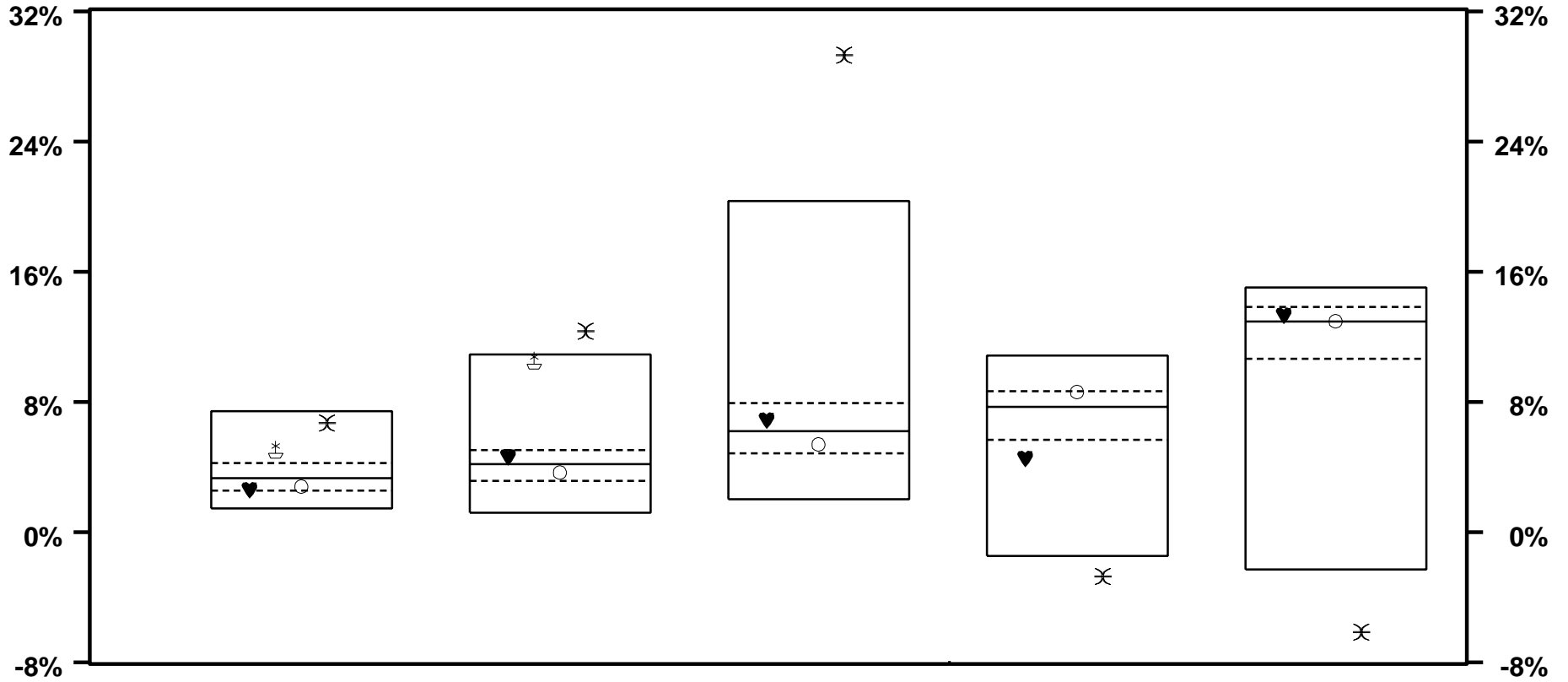

	9 / 05		9 / 04		9 / 03		9 / 02		9 / 01	
♥ SEIX CORE	2.6	73	4.6	39	6.9	41	4.5	82	13.3	38
⊠ SEIX HIGH YIELD	5.1	15	10.6	6						
○ LB AGGREGATE	2.8	67	3.7	62	5.4	65	8.6	25	13.0	49
⌘ ML HIGH YLD II	6.7	6	12.3	1	29.3	1	-2.7	95	-6.1	96
MEDIAN	3.3		4.2		6.2		7.7		12.9	

VERMONT MUNICIPAL EMPLOYEES

BOND FUNDS - TOTAL VS BOND ONLY RETURNS

MARKET CYCLE PERFORMANCE COMPARISONS

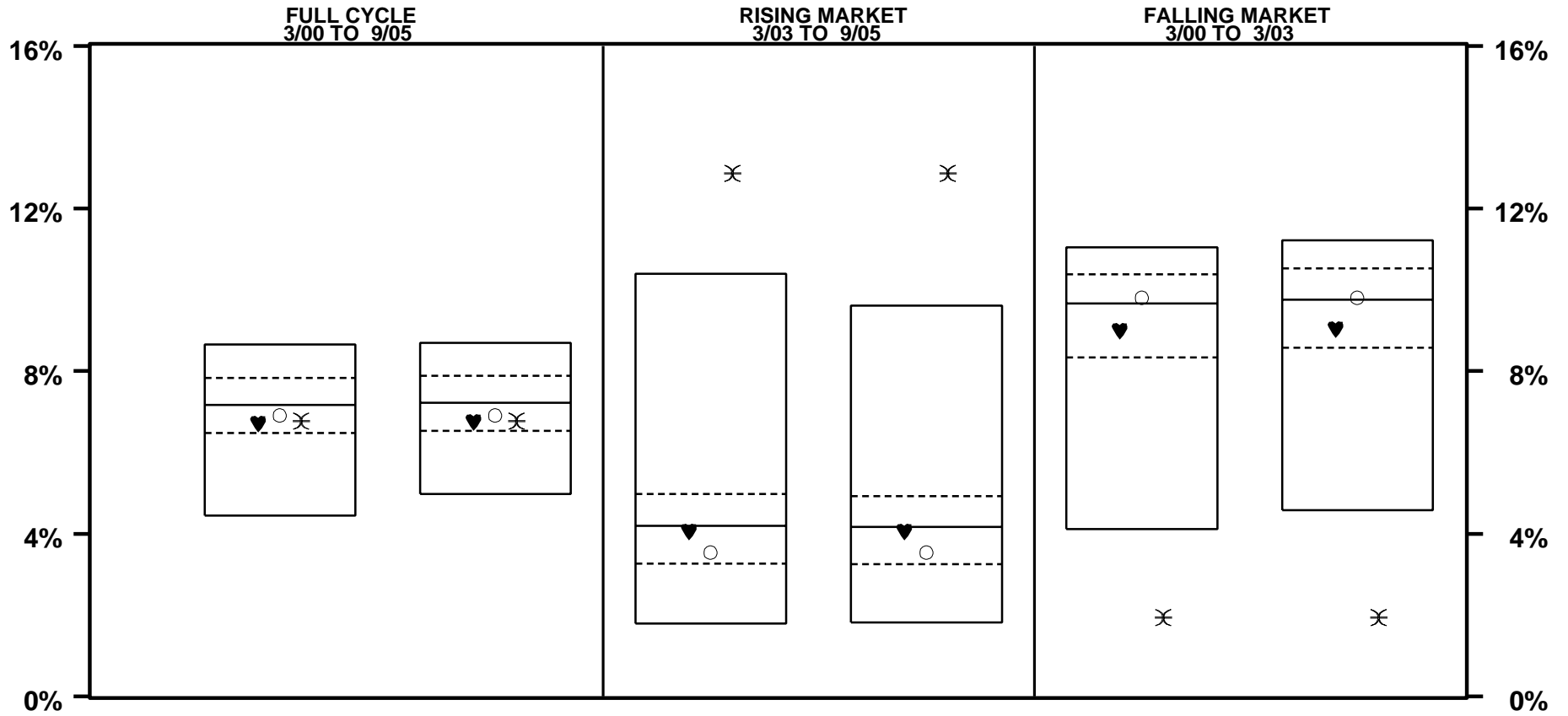

	TOTAL FUND		BONDS ONLY		TOTAL FUND		BONDS ONLY		TOTAL FUND		BONDS ONLY	
♥ SEIX CORE	6.7	68	6.7	68	4.1	53	4.1	52	9.0	66	9.0	67
○ LB AGGREGATE	6.9	60	6.9	62	3.5	67	3.5	66	9.8	44	9.8	47
⌘ ML HIGH YLD II	6.8	66	6.8	68	12.9	1	12.9	1	1.9	97	1.9	97
MEDIAN	7.2		7.2		4.2		4.2		9.7		9.8	

VERMONT MUNICIPAL EMPLOYEES

BOND FUNDS - TOTAL FUND INCOME RATES OF RETURN

FOR PERIOD ENDING 9/05

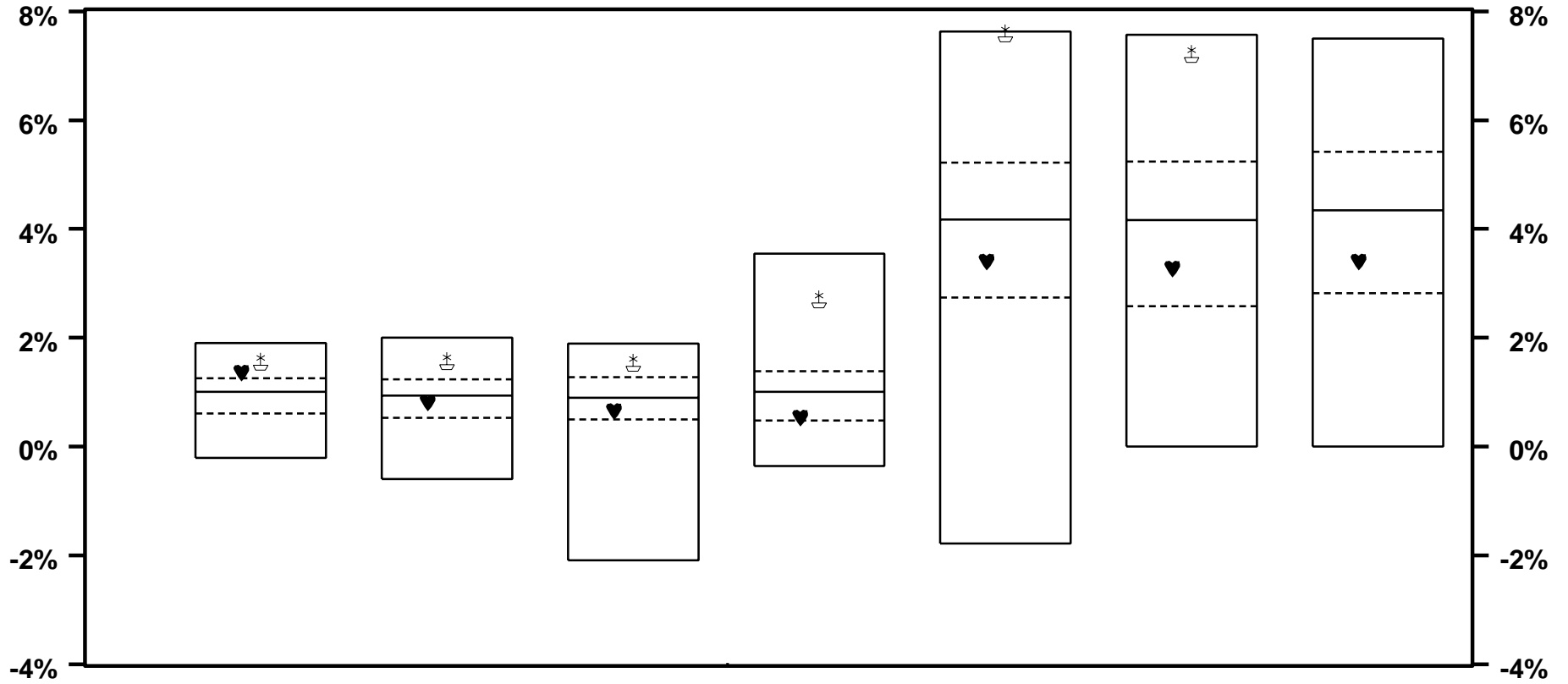

	THIS QUARTER	LAST QUARTER	2 QTRS AGO	3 QTRS AGO	LAST YEAR	LAST 2 YEARS	LAST 3 YEARS
♥ SEIX CORE	1.4 18	0.8 63	0.7 61	0.5 73	3.4 63	3.3 63	3.4 64
⚓ SEIX HIGH YIELD	1.6 11	1.6 12	1.5 12	2.7 7	7.6 5	7.2 6	
MEDIAN	1.0	0.9	0.9	1.0	4.2	4.2	4.3

VERMONT MUNICIPAL EMPLOYEES

BOND FUNDS - TOTAL RETURN VS RISK

3 YEARS ENDING 9/05

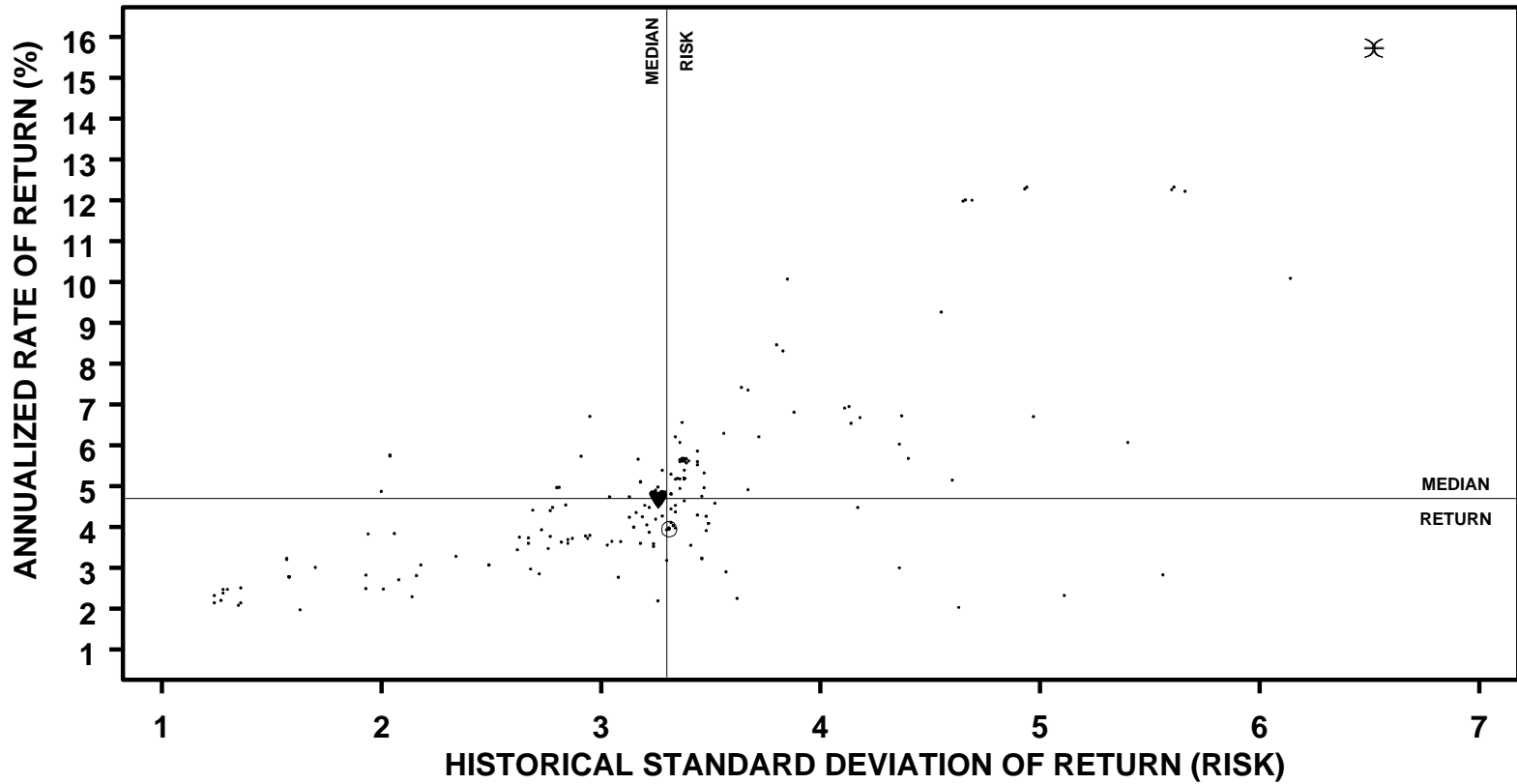

	ANNUALIZED RETURN		STANDARD DEVIATION		SHARPE RATIO	
	VALUE	RANK	VALUE	RANK	VALUE	RANK
♥ SEIX CORE	4.7	49	3.3	58	0.9	51
○ LB AGGREGATE	4.0	66	3.3	53	0.7	70
⌘ ML HIGH YLD II	15.7	1	6.5	4	2.1	5
MEDIAN	4.7		3.3		0.9	

VERMONT MUNICIPAL EMPLOYEES

BOND FUNDS - TOTAL RETURN VS RISK

5 YEARS ENDING 9/05

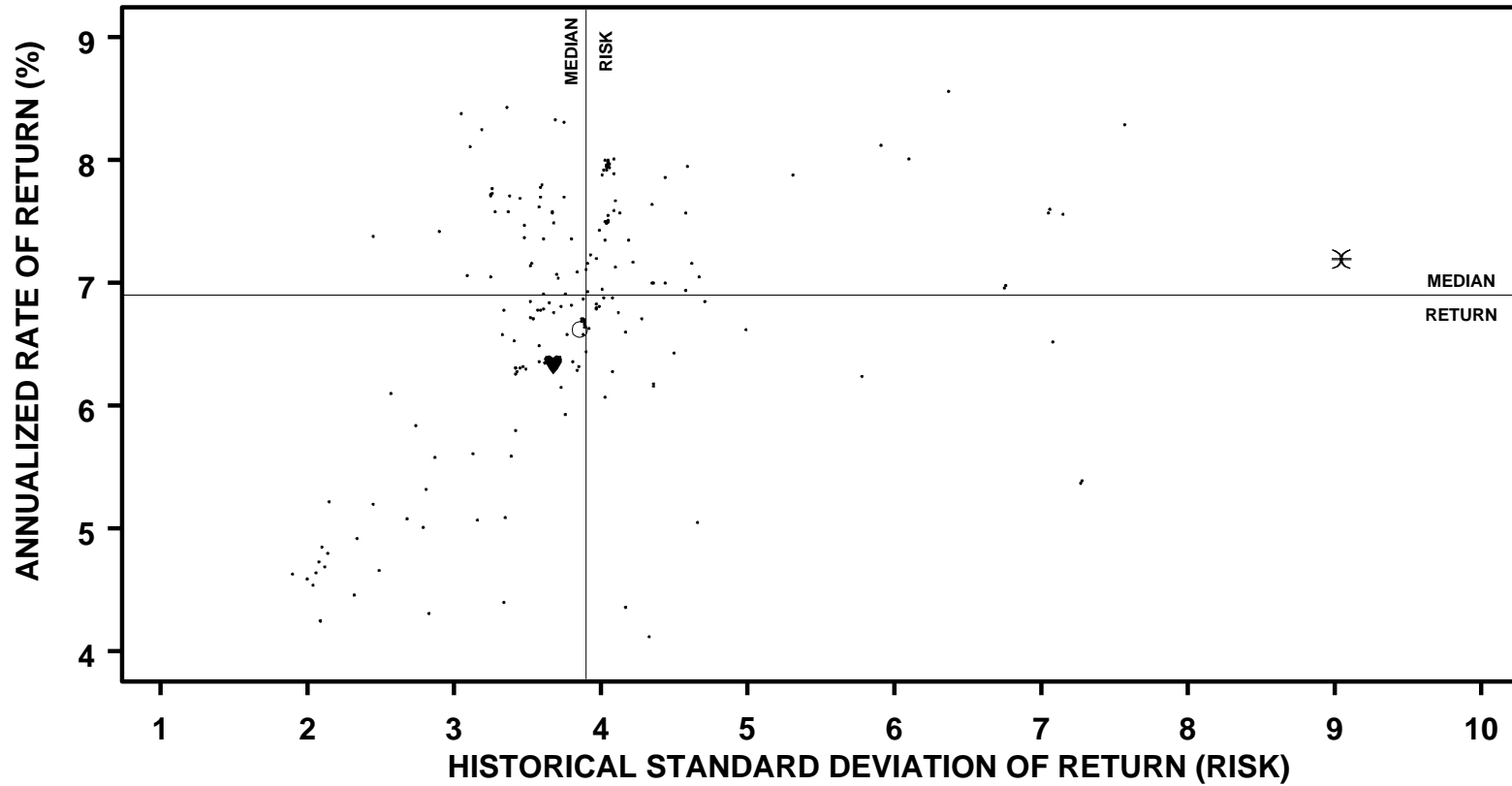

	ANNUALIZED RETURN		STANDARD DEVIATION		SHARPE RATIO	
	VALUE	RANK	VALUE	RANK	VALUE	RANK
♥ SEIX CORE	6.3	70	3.7	63	1.0	61
○ LB AGGREGATE	6.6	62	3.9	51	1.1	56
⊗ ML HIGH YLD II	7.2	39	9.0	2	0.5	93
MEDIAN	6.9		3.9		1.1	

VERMONT MUNICIPAL EMPLOYEES

BOND ONLY - RATES OF RETURN

PERIODS ENDING 9/05

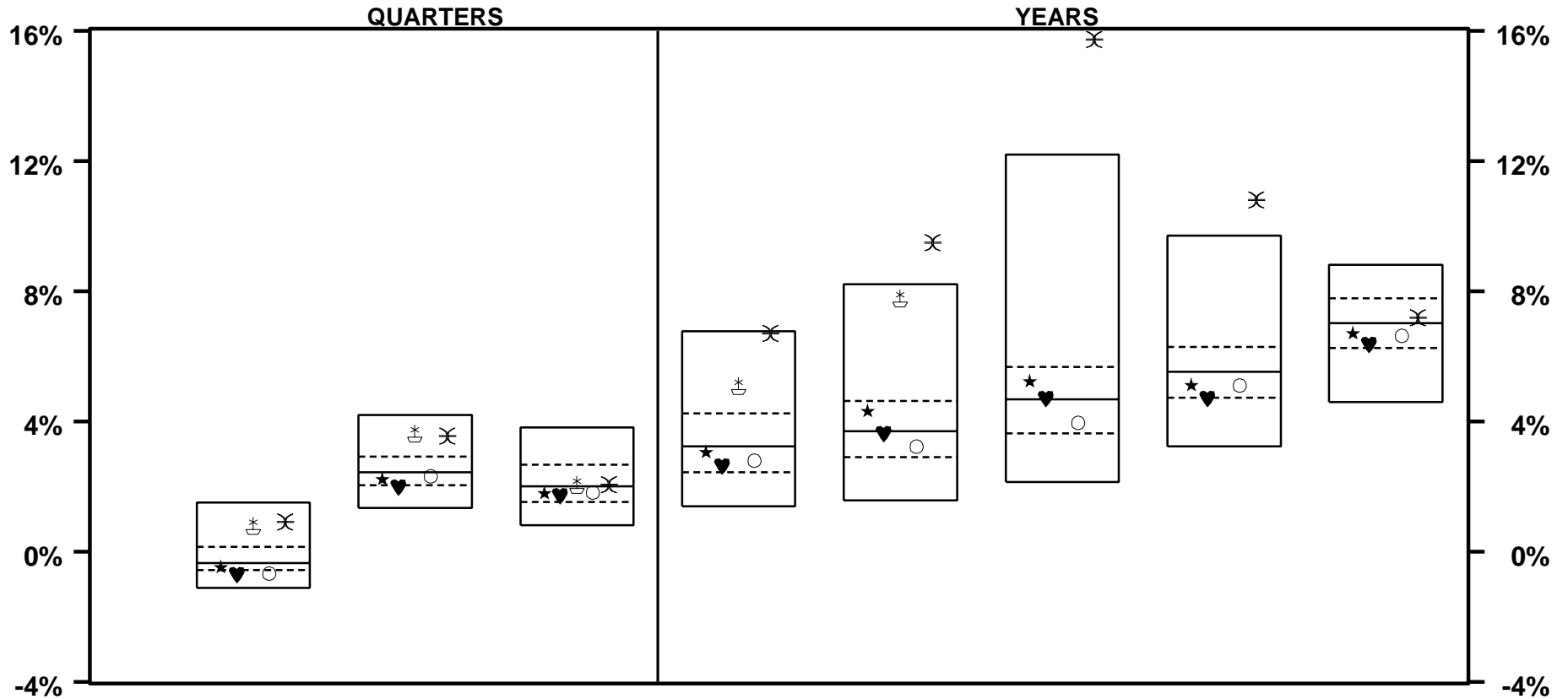

	LAST QTR		LAST 2 QTRS		LAST 3 QTRS		LAST YEAR		LAST 2 YEARS		LAST 3 YEARS		LAST 4 YEARS		LAST 5 YEARS	
★ MUNI COMPOSITE	-0.5	67	2.2	65	1.8	61	3.1	55	4.3	35	5.2	37	5.1	63	6.7	60
♥ SEIX CORE	-0.7	86	2.0	77	1.7	66	2.6	70	3.6	52	4.7	49	4.7	75	6.4	71
⊠ SEIX HIGH YIELD	0.8	11	3.6	8	2.1	47	5.1	14	7.8	7						
○ LB AGGREGATE	-0.7	82	2.3	58	1.8	60	2.8	64	3.2	65	4.0	66	5.1	65	6.6	64
⌘ ML HIGH YLD II	0.9	8	3.6	10	2.1	46	6.7	5	9.5	2	15.7	1	10.8	2	7.2	42
MEDIAN	-0.4		2.4		2.0		3.2		3.7		4.7		5.5		7.0	

VERMONT MUNICIPAL EMPLOYEES

BOND ONLY - RATES OF RETURN

PERIODS ENDING 9/05

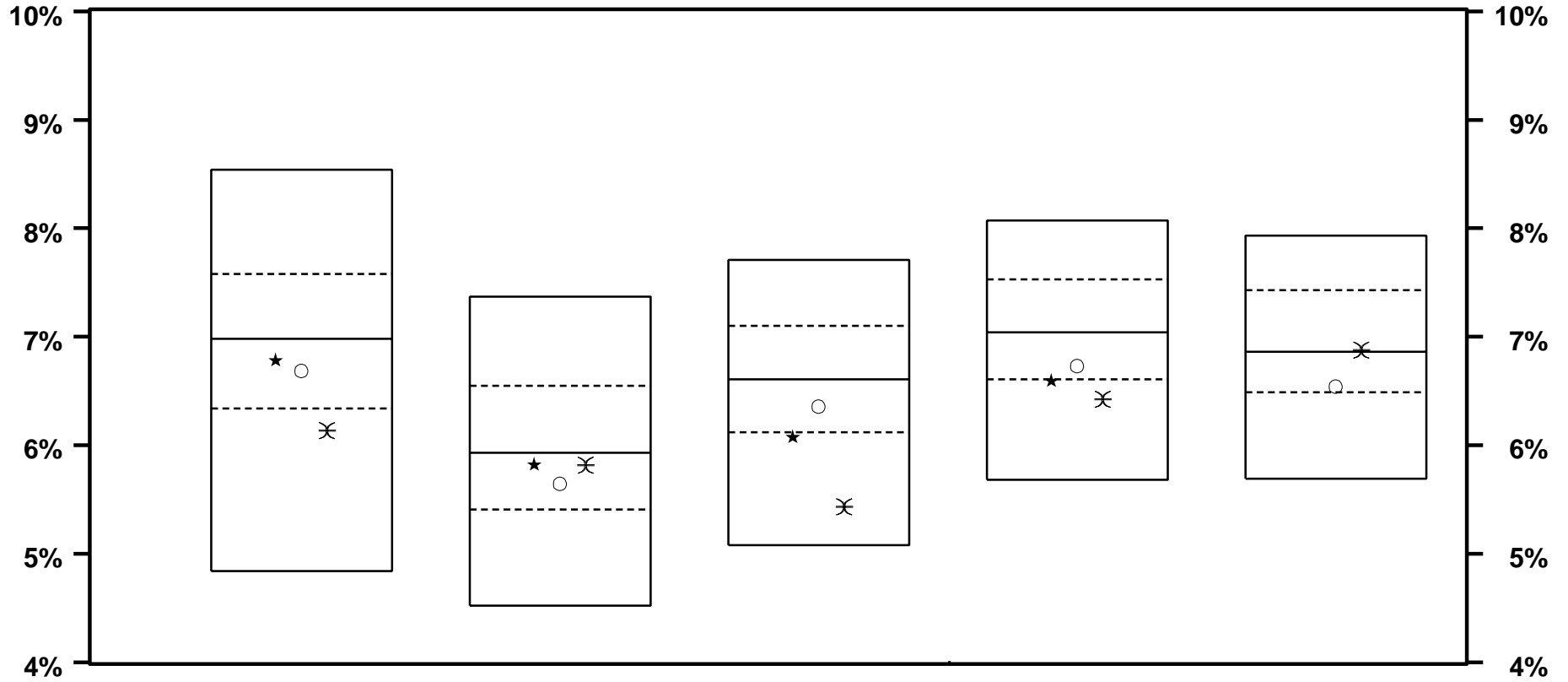

	LAST 6 YEARS		LAST 7 YEARS		LAST 8 YEARS		LAST 9 YEARS		LAST 10 YEARS	
★ MUNI COMPOSITE	6.8	58	5.8	55	6.1	76	6.6	75		
○ LB AGGREGATE	6.7	63	5.6	64	6.4	63	6.7	66	6.5	70
✕ ML HIGH YLD II	6.1	81	5.8	55	5.4	91	6.4	81	6.9	47
MEDIAN	7.0		5.9		6.6		7.0		6.9	

VERMONT MUNICIPAL EMPLOYEES

BOND ONLY - RATES OF RETURN

YEARS ENDING

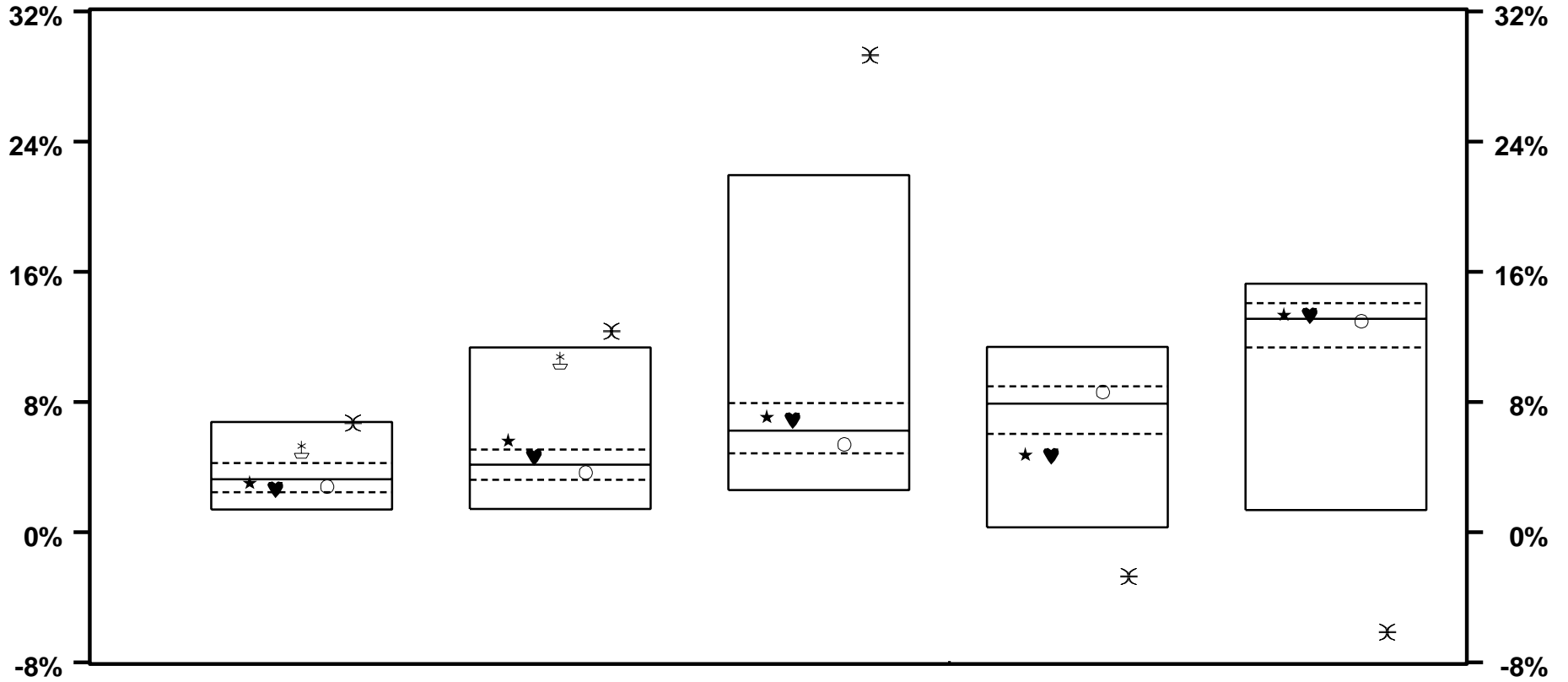

	9 / 05		9 / 04		9 / 03		9 / 02		9 / 01	
★ MUNI COMPOSITE	3.1	55	5.6	20	7.1	39	4.8	85	13.4	42
♥ SEIX CORE	2.6	70	4.6	39	6.9	41	4.7	85	13.3	43
⊠ SEIX HIGH YIELD	5.1	14	10.6	7						
○ LB AGGREGATE	2.8	64	3.7	62	5.4	65	8.6	31	13.0	53
✱ ML HIGH YLD II	6.7	5	12.3	2	29.3	1	-2.7	97	-6.1	98
MEDIAN	3.2		4.2		6.2		7.9		13.1	

VERMONT MUNICIPAL EMPLOYEES

BOND ONLY - RATES OF RETURN

YEARS ENDING

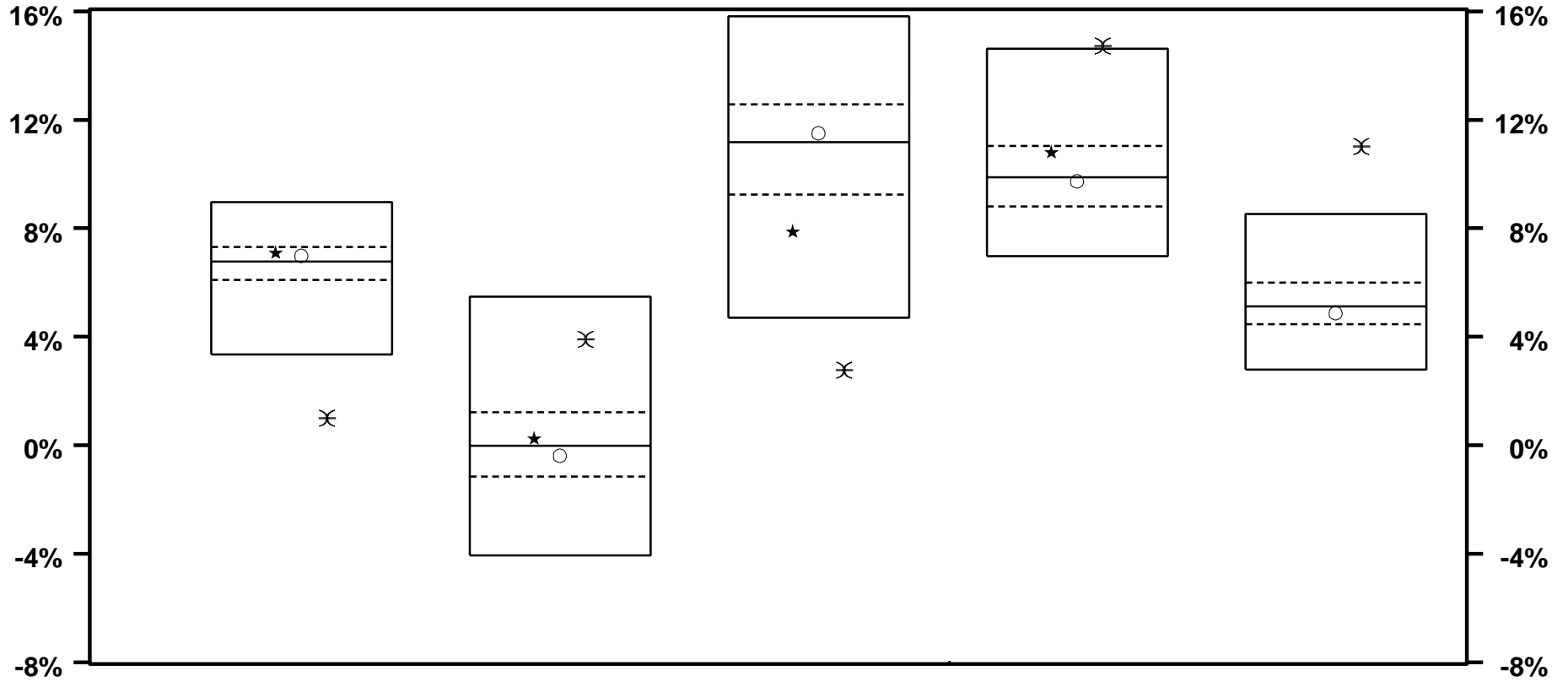

	9 / 00		9 / 99		9 / 98		9 / 97		9 / 96	
★ MUNI COMPOSITE	7.1	34	0.3	43	7.9	86	10.8	28		
○ LB AGGREGATE	7.0	40	-0.4	59	11.5	43	9.7	54	4.9	60
✕ ML HIGH YLD II	1.0	97	3.9	8	2.8	96	14.7	4	11.0	2
MEDIAN	6.8		0.0		11.2		9.9		5.1	

VERMONT MUNICIPAL EMPLOYEES

BOND ONLY RETURNS VS RISK
3 YEARS ENDING 9/05

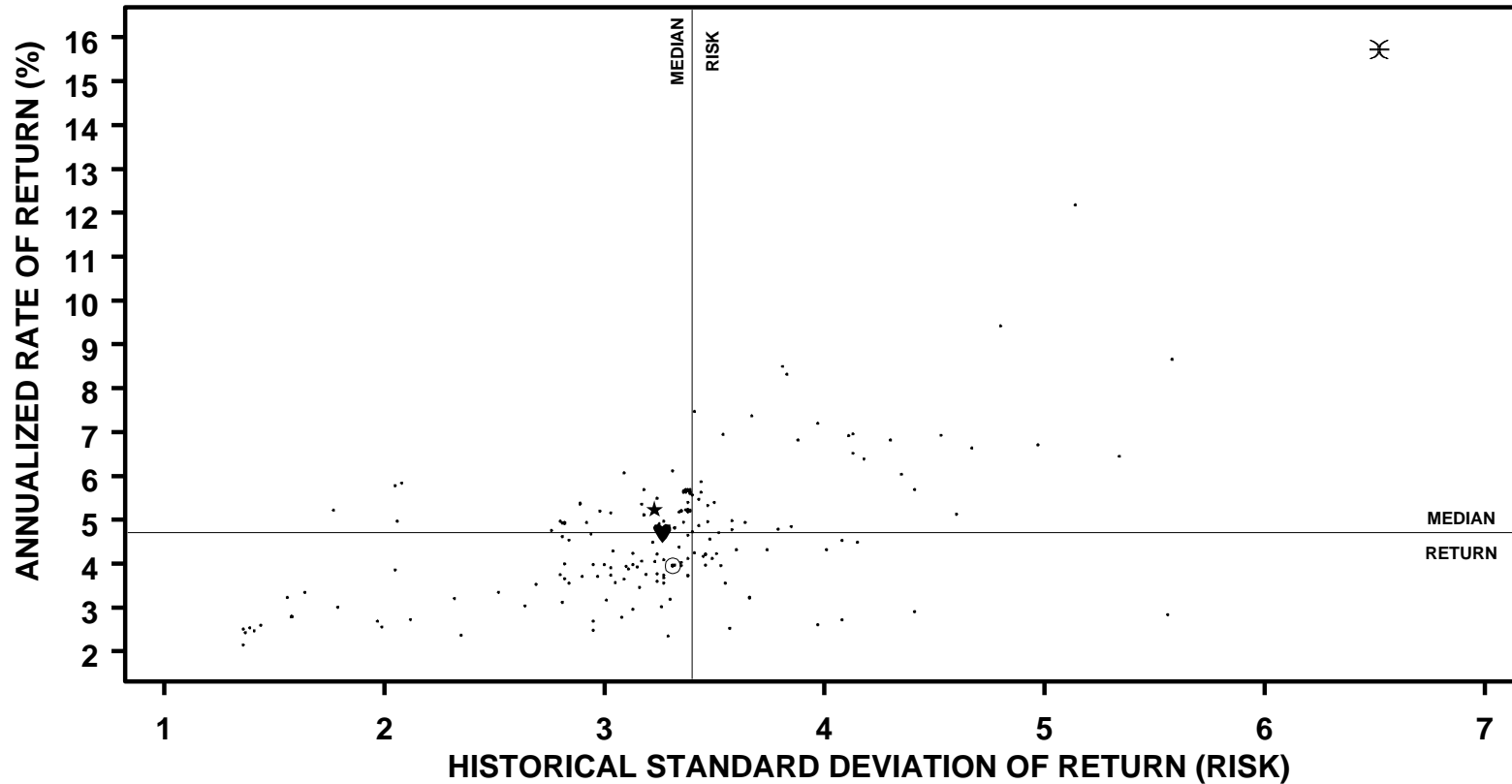

	ANNUALIZED RETURN		STANDARD DEVIATION		SHARPE RATIO	
	VALUE	RANK	VALUE	RANK	VALUE	RANK
★ MUNI COMPOSITE	5.2	37	3.2	64	1.1	35
♥ SEIX CORE	4.7	49	3.3	63	0.9	47
○ LB AGGREGATE	4.0	66	3.3	58	0.7	67
⌘ ML HIGH YLD II	15.7	1	6.5	5	2.1	4
MEDIAN	4.7		3.4		0.9	

VERMONT MUNICIPAL EMPLOYEES

BOND ONLY RETURNS VS RISK

5 YEARS ENDING 9/05

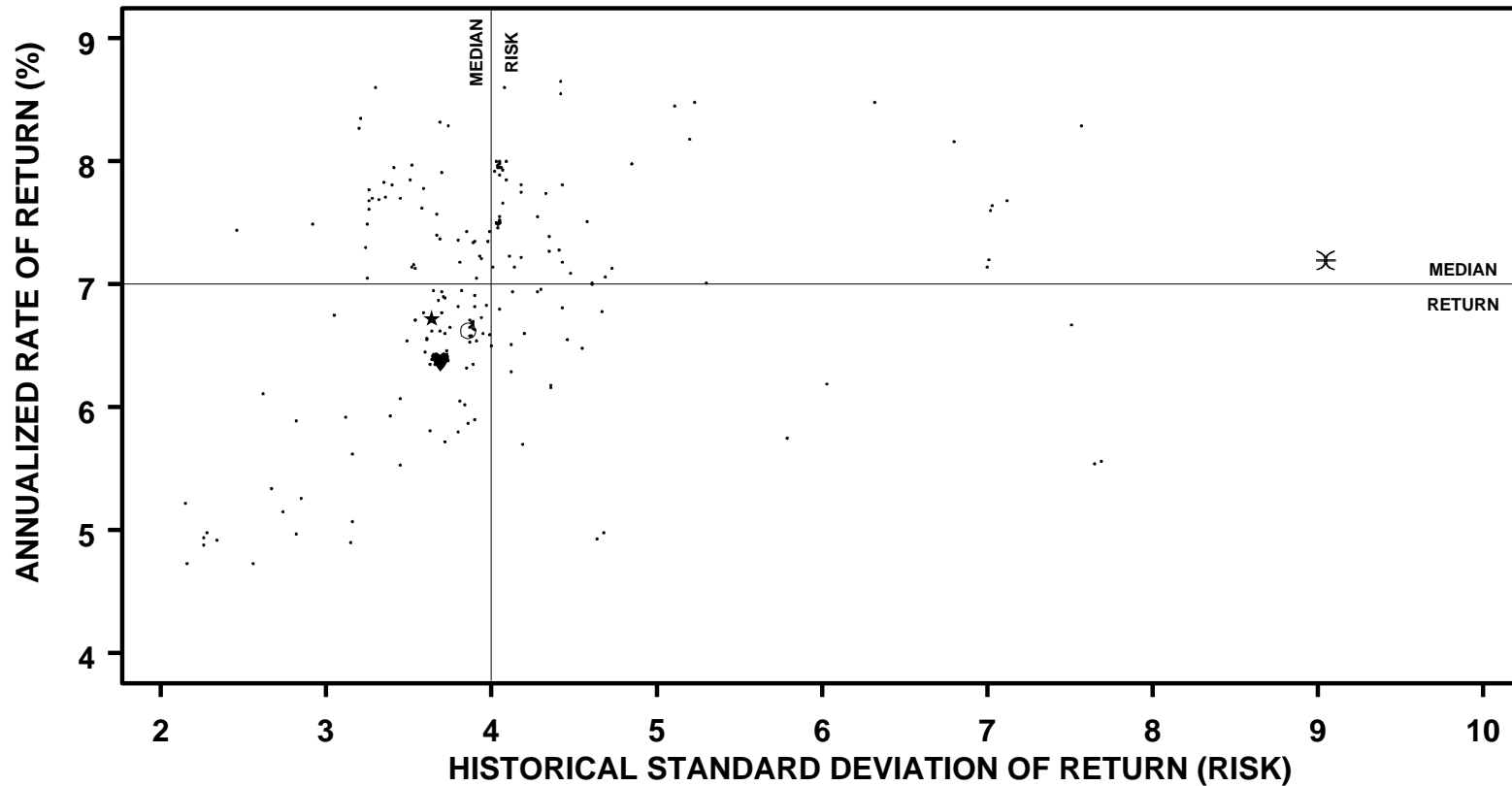

	ANNUALIZED RETURN		STANDARD DEVIATION		SHARPE RATIO	
	VALUE	RANK	VALUE	RANK	VALUE	RANK
★ MUNI COMPOSITE	6.7	60	3.6	71	1.1	40
♥ SEIX CORE	6.4	71	3.7	68	1.0	57
○ LB AGGREGATE	6.6	64	3.9	60	1.1	52
⌘ ML HIGH YLD II	7.2	42	9.0	2	0.5	94
MEDIAN	7.0		4.0		1.1	

VERMONT MUNICIPAL EMPLOYEES

CASH FUNDS - TOTAL RATES OF RETURN

PERIODS ENDING 9/05

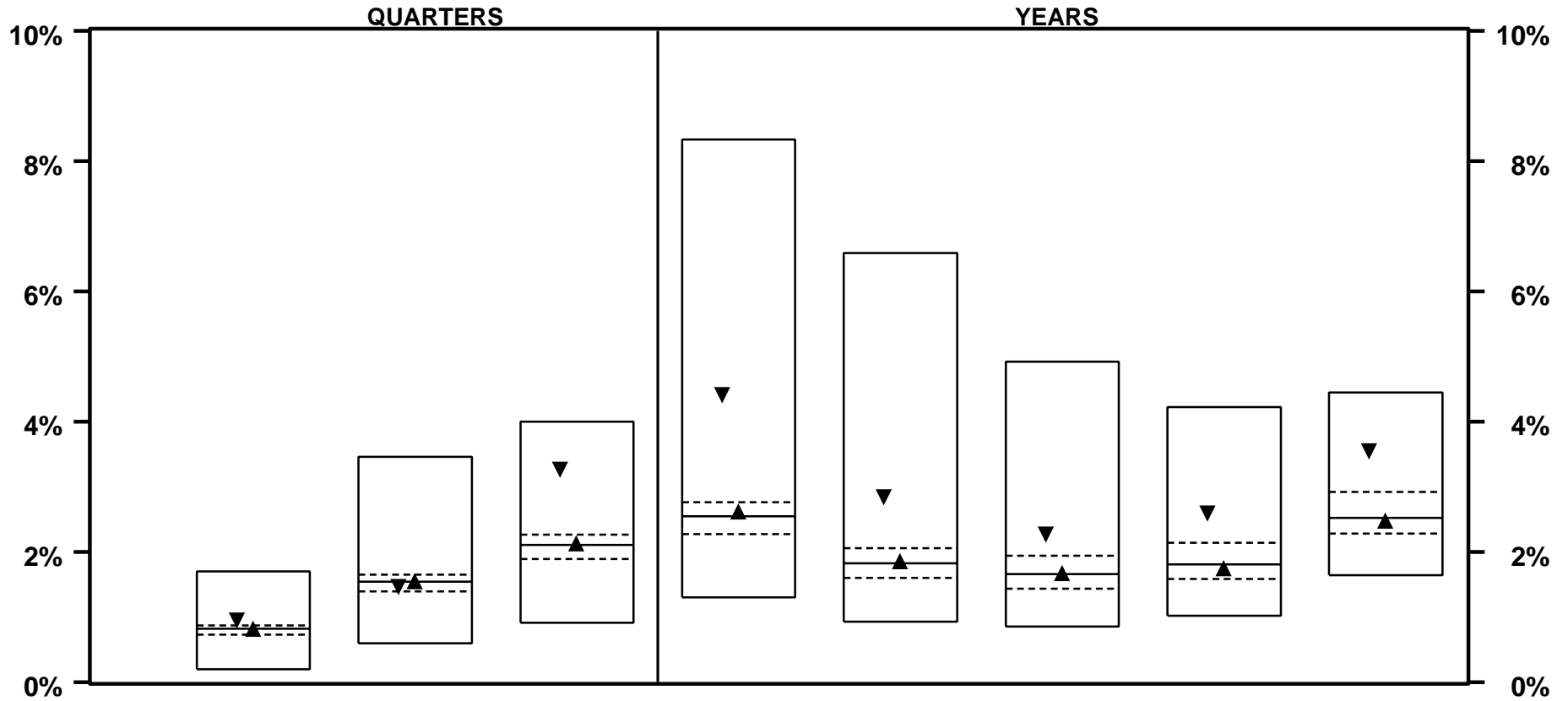

	LAST QTR		LAST 2 QTRS		LAST 3 QTRS		LAST YEAR		LAST 2 YEARS		LAST 3 YEARS		LAST 4 YEARS		LAST 5 YEARS	
▼ VERMONT INVEST	1.0	13	1.5	65	3.3	7	4.4	8	2.8	10	2.3	16	2.6	14	3.5	13
▲ 90 DAY T-BILLS	0.8	46	1.6	45	2.1	45	2.6	38	1.9	42	1.7	46	1.8	56	2.5	54
MEDIAN	0.8		1.5		2.1		2.6		1.8		1.7		1.8		2.5	

VERMONT MUNICIPAL EMPLOYEES

CASH FUNDS - TOTAL RATES OF RETURN

PERIODS ENDING 9/05

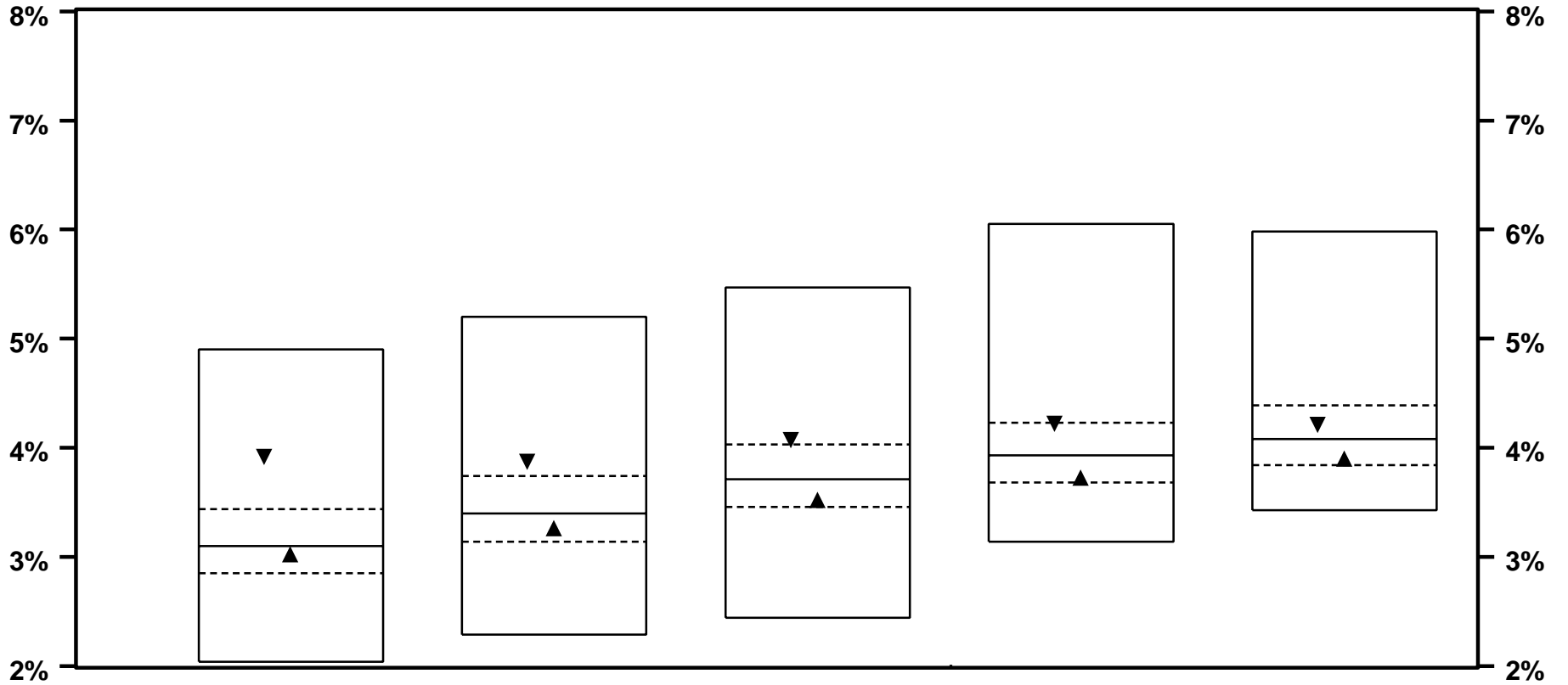

	LAST 6 YEARS	LAST 7 YEARS	LAST 8 YEARS	LAST 9 YEARS	LAST 10 YEARS
▼ VERMONT INVEST	3.9 15	3.9 22	4.1 22	4.2 25	4.2 36
▲ 90 DAY T-BILLS	3.0 58	3.3 63	3.5 66	3.7 67	3.9 68
MEDIAN	3.1	3.4	3.7	3.9	4.1

VERMONT MUNICIPAL EMPLOYEES

CASH FUNDS - TOTAL RATES OF RETURN

YEARS ENDING

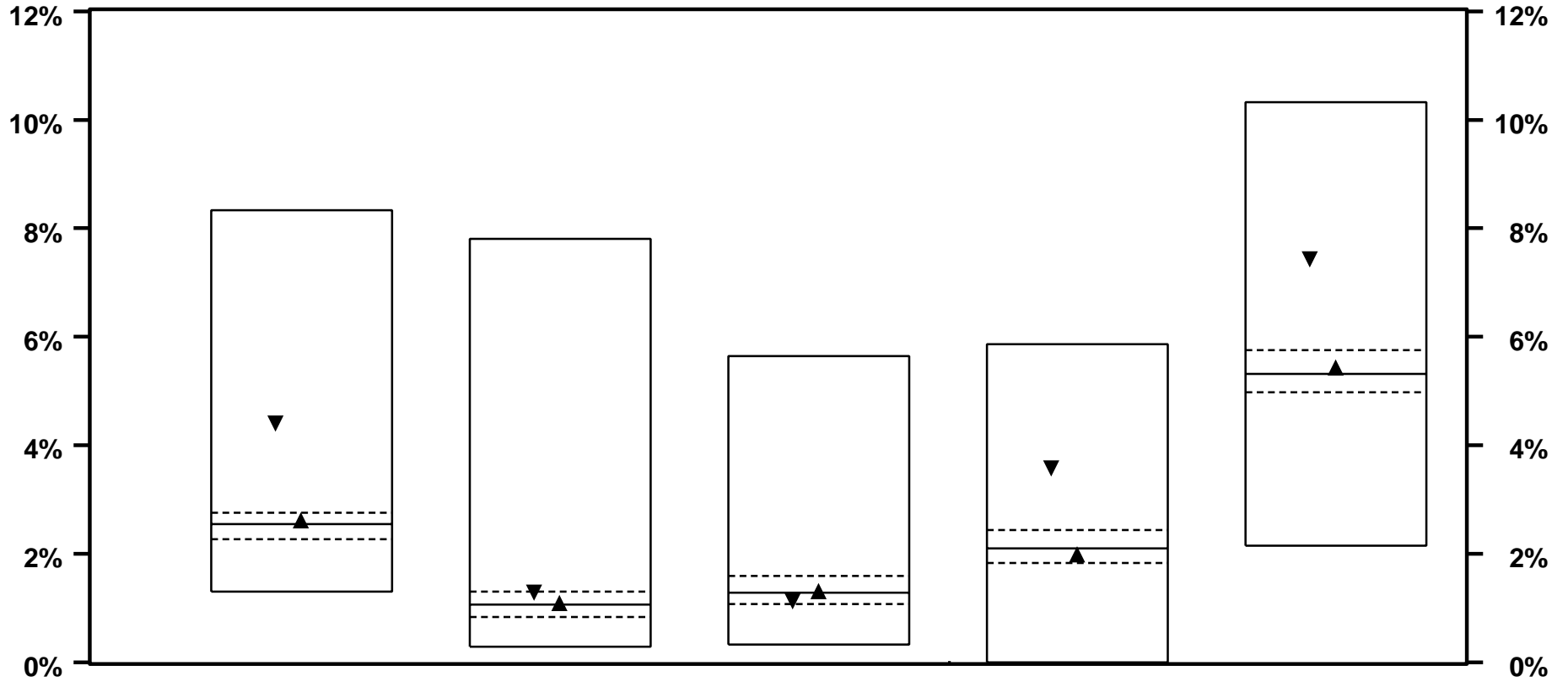

	9 / 05	9 / 04	9 / 03	9 / 02	9 / 01
▼ VERMONT INVEST	4.4 8	1.3 25	1.1 68	3.6 12	7.4 10
▲ 90 DAY T-BILLS	2.6 38	1.1 42	1.3 45	2.0 61	5.4 39
MEDIAN	2.6	1.1	1.3	2.1	5.3

VERMONT MUNICIPAL EMPLOYEES

CASH FUNDS - TOTAL RATES OF RETURN

YEARS ENDING

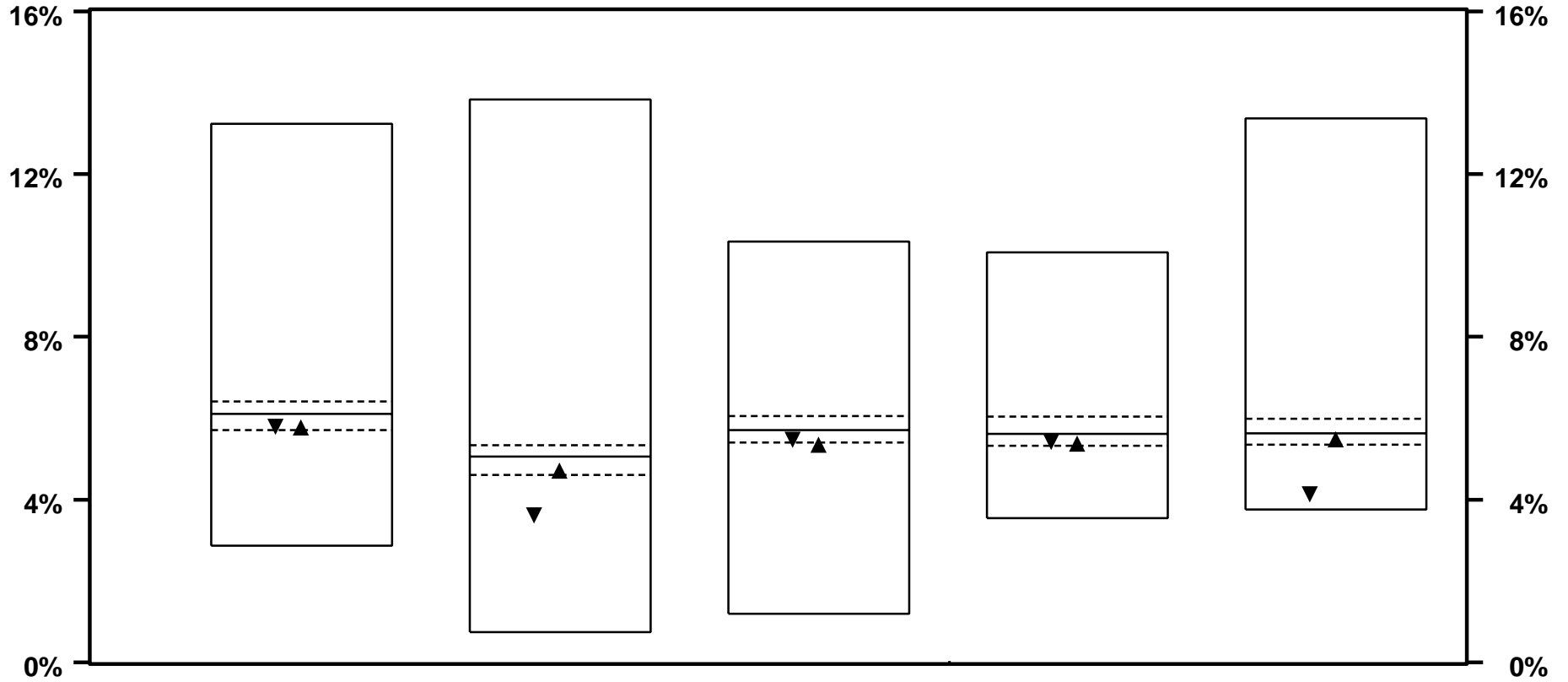

	9 / 00	9 / 99	9 / 98	9 / 97	9 / 96
▼ VERMONT INVEST	5.8 70	3.6 89	5.5 69	5.4 67	4.1 93
▲ 90 DAY T-BILLS	5.8 71	4.7 69	5.4 76	5.4 70	5.5 65
 MEDIAN	 6.1	 5.0	 5.7	 5.6	 5.6

VERMONT MUNICIPAL EMPLOYEES

CASH EQUIVALENTS - RATES OF RETURN

PERIODS ENDING 9/05

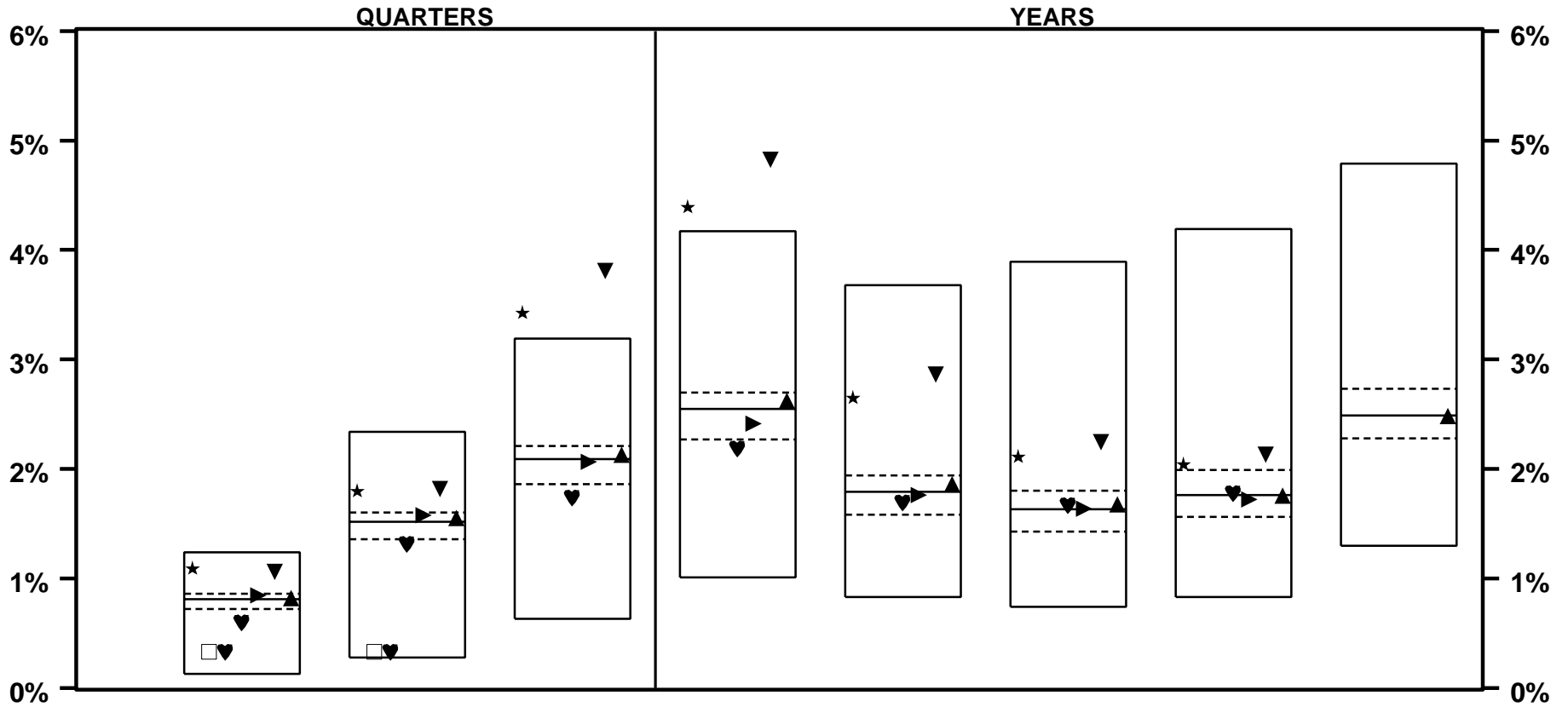

	LAST QTR		LAST 2 QTRS		LAST 3 QTRS		LAST YEAR		LAST 2 YEARS		LAST 3 YEARS		LAST 4 YEARS		LAST 5 YEARS	
★ MUNI COMPOSITE	1.1	6	1.8	9	3.4	4	4.4	4	2.6	8	2.1	13	2.0	22		
□ EQTY COMPOSITE	0.3	93	0.3	94												
♥ DELAWARE	0.3	93	0.3	94												
♥ UBS	0.6	85	1.3	78	1.7	81	2.2	78	1.7	63	1.7	41	1.8	46		
▶ ALT. ASSETS	0.9	26	1.6	29	2.1	53	2.4	63	1.8	55	1.6	45	1.7	56		
▼ VERMONT INVEST	1.1	7	1.8	9	3.8	3	4.8	4	2.9	7	2.2	11	2.1	18		
▲ 90 DAY T-BILLS	0.8	43	1.6	38	2.1	40	2.6	35	1.9	34	1.7	38	1.8	51	2.5	50
MEDIAN	0.8		1.5		2.1		2.6		1.8		1.6		1.8		2.5	

VERMONT MUNICIPAL EMPLOYEES

CASH EQUIVALENTS - RATES OF RETURN

YEARS ENDING

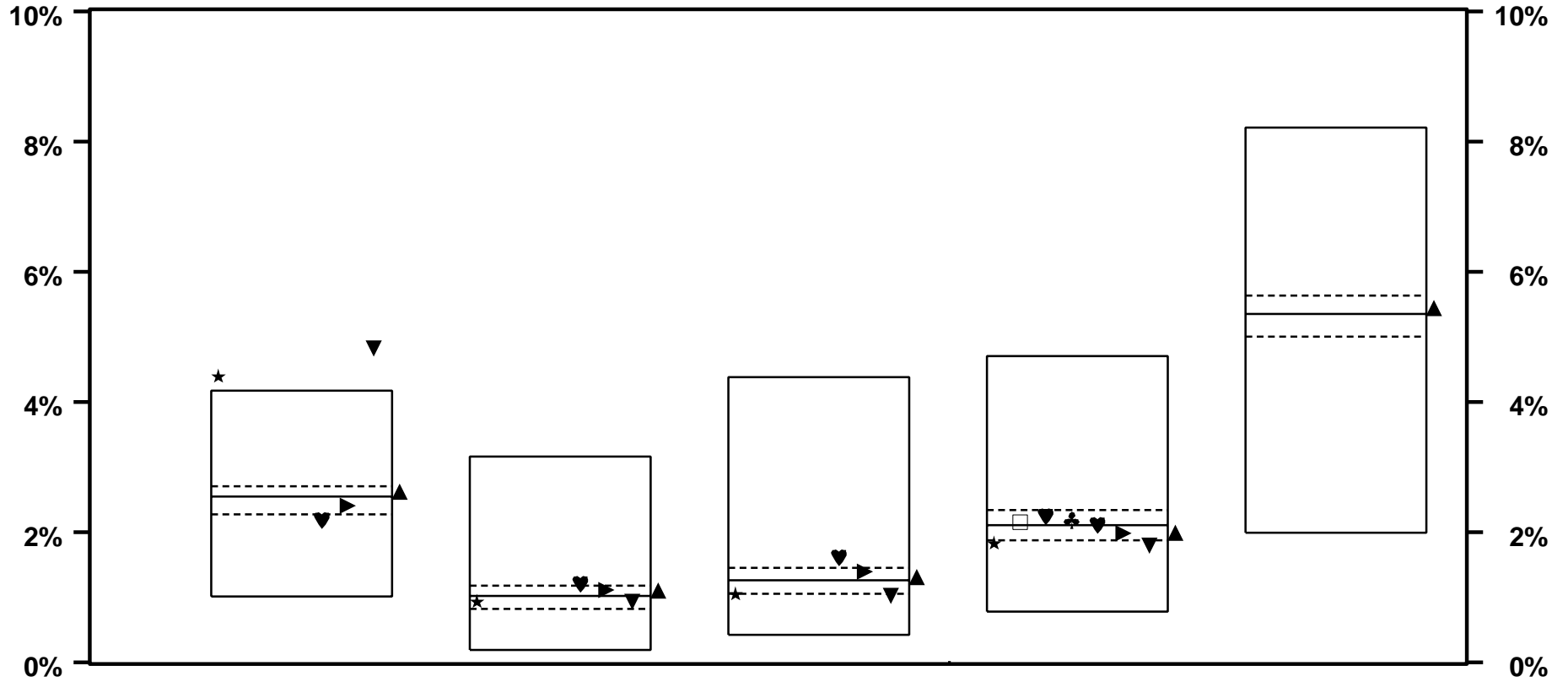

	9 / 05		9 / 04		9 / 03		9 / 02		9 / 01	
★ MUNI COMPOSITE	4.4	4	0.9	65	1.1	74	1.8	77		
□ EQTY COMPOSITE							2.2	43		
♥ DELAWARE							2.2	32		
♣ ALLIANCE							2.2	38		
♥ UBS	2.2	78	1.2	23	1.6	17	2.1	49		
▶ ALT. ASSETS	2.4	63	1.1	32	1.4	29	2.0	66		
▼ VERMONT INVEST	4.8	4	0.9	65	1.0	76	1.8	79		
▲ 90 DAY T-BILLS	2.6	35	1.1	34	1.3	40	2.0	65	5.4	37
MEDIAN	2.6		1.0		1.3		2.1		5.4	

VERMONT MUNICIPAL EMPLOYEES

INT'L DEVELOPED MKT EQUITY FUNDS - RATES OF RETURN

PERIODS ENDING 9/05

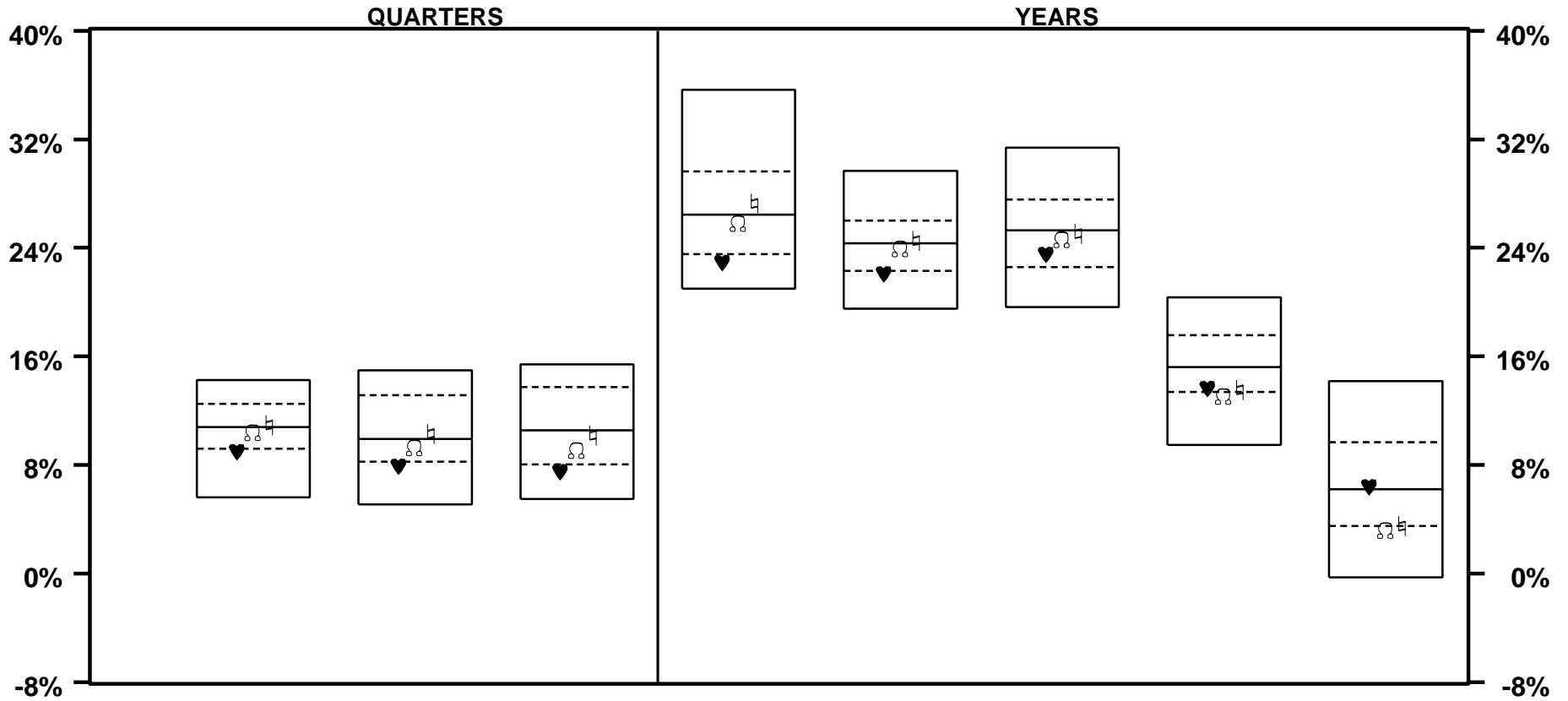

	LAST QTR		LAST 2 QTRS		LAST 3 QTRS		LAST YEAR		LAST 2 YEARS		LAST 3 YEARS		LAST 4 YEARS		LAST 5 YEARS	
♥ UBS	9.0	77	7.9	77	7.5	79	22.9	78	22.1	76	23.5	68	13.6	71	6.4	49
⊙ MS EAFE NET	10.4	56	9.3	61	9.1	66	25.8	59	23.9	54	24.6	61	13.1	77	3.2	78
⊠ CITI PMI EPAC	11.0	47	10.3	46	10.2	53	27.3	42	24.5	48	25.1	52	13.5	73	3.5	74
MEDIAN	10.8		9.9		10.6		26.4		24.3		25.3		15.2		6.2	

VERMONT MUNICIPAL EMPLOYEES

INT'L DEVELOPED MKT EQUITY FUNDS - RATES OF RETURN

PERIODS ENDING 9/05

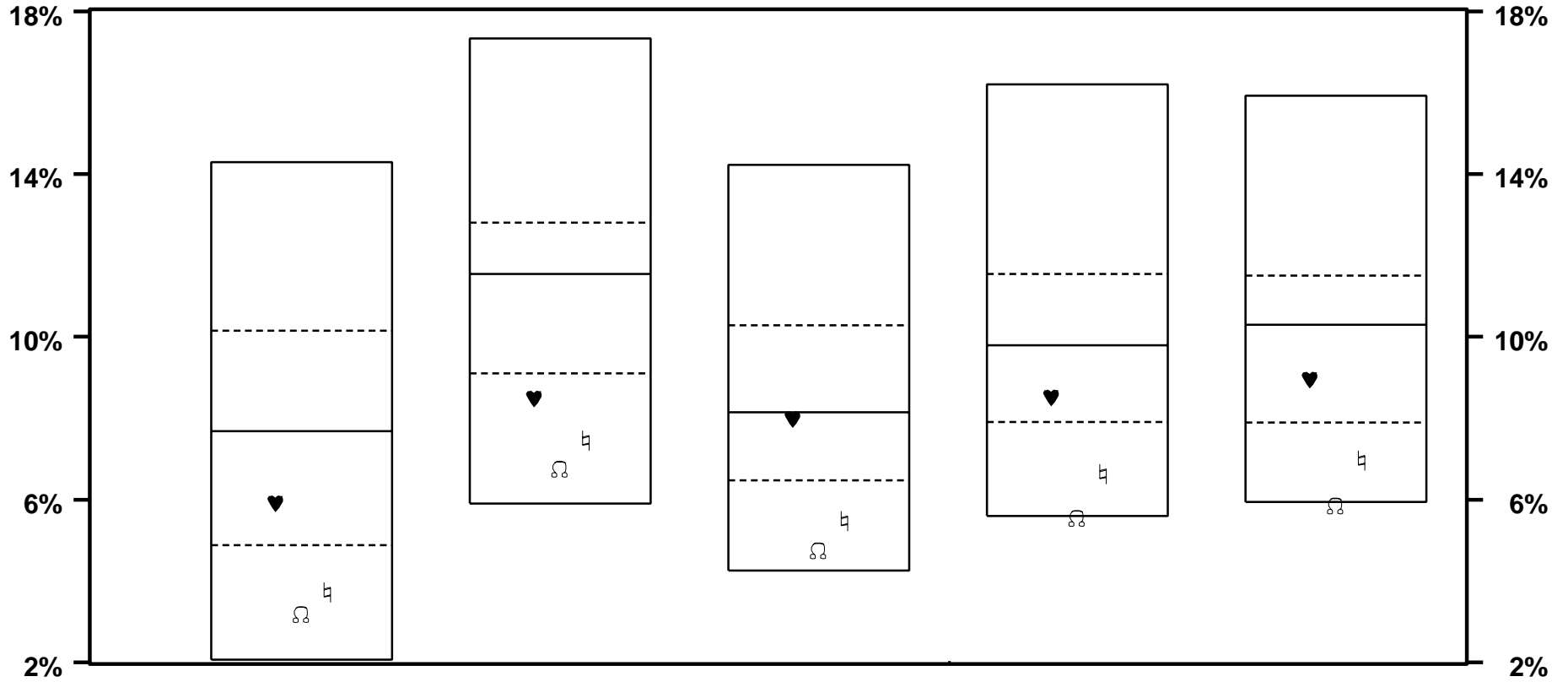

	LAST 6 YEARS		LAST 7 YEARS		LAST 8 YEARS		LAST 9 YEARS		LAST 10 YEARS	
♥ UBS	5.9	67	8.5	78	8.0	54	8.5	70	9.0	68
○ MS EAFE NET	3.2	89	6.8	88	4.7	90	5.5	95	5.8	95
⊞ CITI PMI EPAC	3.7	83	7.5	83	5.5	80	6.6	84	7.0	84
MEDIAN	7.7		11.5		8.2		9.8		10.3	

VERMONT MUNICIPAL EMPLOYEES

INT'L DEVELOPED MKT EQUITY FUNDS - RATES OF RETURN

YEARS ENDING

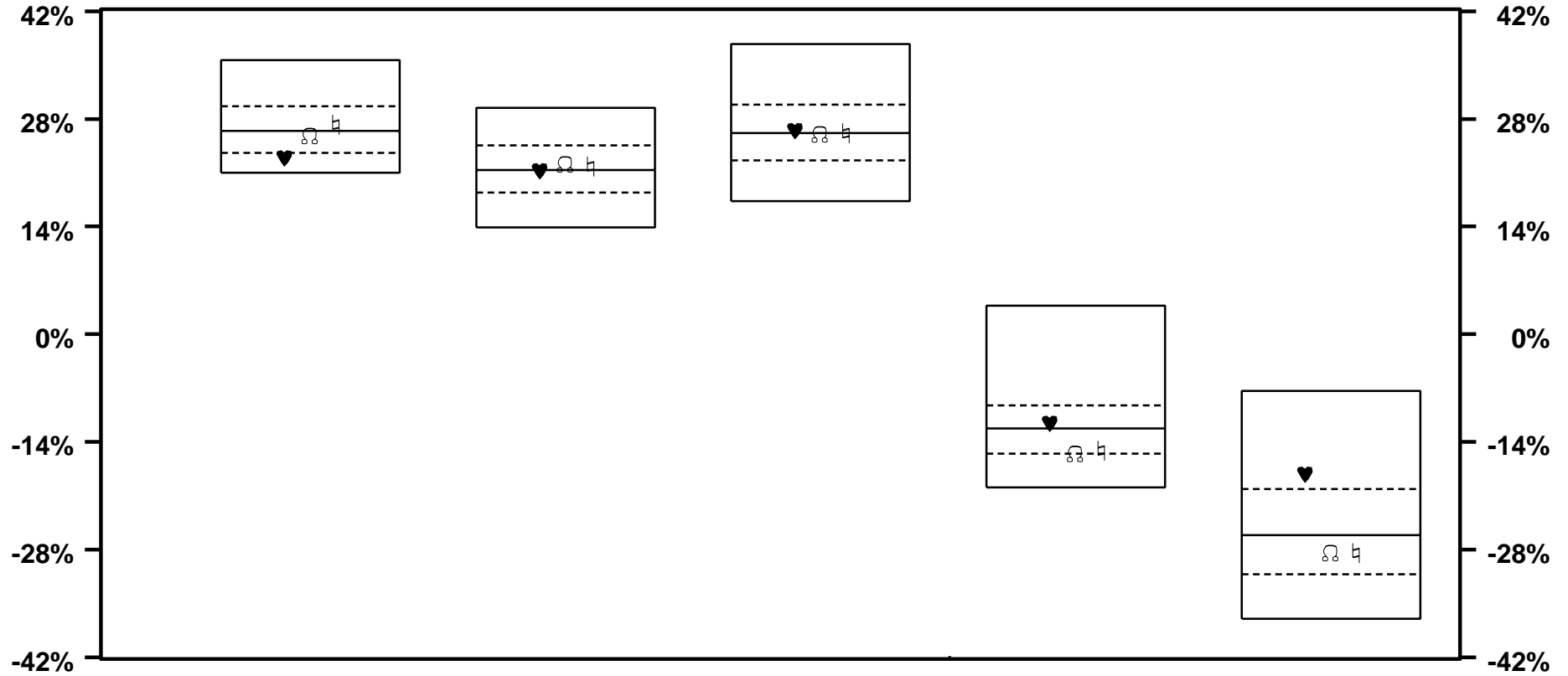

	9 / 05		9 / 04		9 / 03		9 / 02		9 / 01	
♥ UBS	22.9	78	21.3	53	26.5	47	-11.5	39	-18.2	20
Ω MS EAFE NET	25.8	59	22.1	43	26.0	50	-15.5	75	-28.5	65
□ CITI PMI EPAC	27.3	42	21.9	44	26.1	50	-15.1	69	-28.4	65
MEDIAN	26.4		21.3		26.2		-12.2		-26.1	

VERMONT MUNICIPAL EMPLOYEES

INT'L DEVELOPED MKT EQUITY FUNDS - RATES OF RETURN

YEARS ENDING

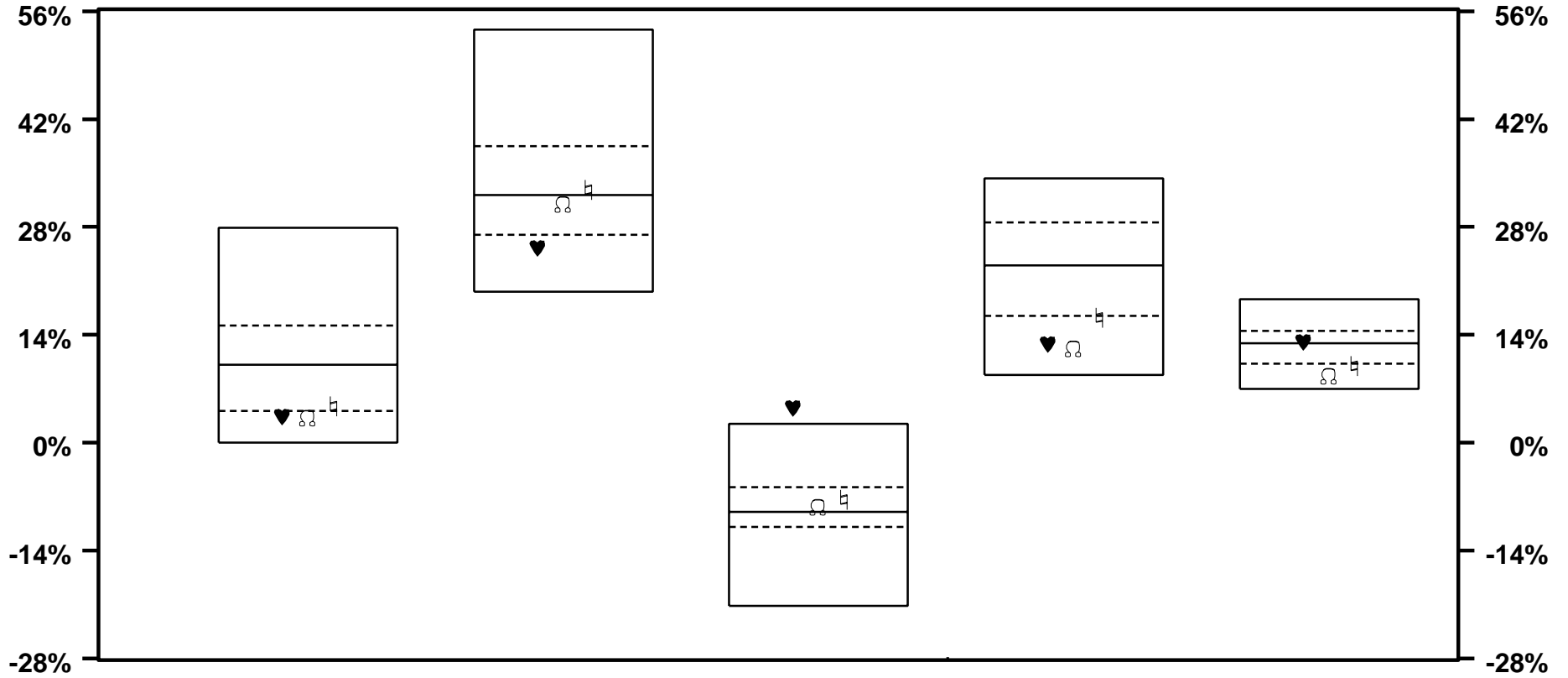

	9 / 00		9 / 99		9 / 98		9 / 97		9 / 96	
♥ UBS	3.4	79	25.3	81	4.5	2	12.8	86	13.1	46
⊙ MS EAFE NET	3.2	81	31.0	57	-8.3	43	12.2	88	8.6	88
⊠ CITI PMI EPAC	4.8	73	32.9	46	-7.4	34	16.3	76	10.0	76
MEDIAN	10.1		32.1		-9.0		23.0		12.9	

VERMONT MUNICIPAL EMPLOYEES

INT'L DEVELOPED MKT EQUITY FUNDS - TOTAL RETURN VS RISK

3 YEARS ENDING 9/05

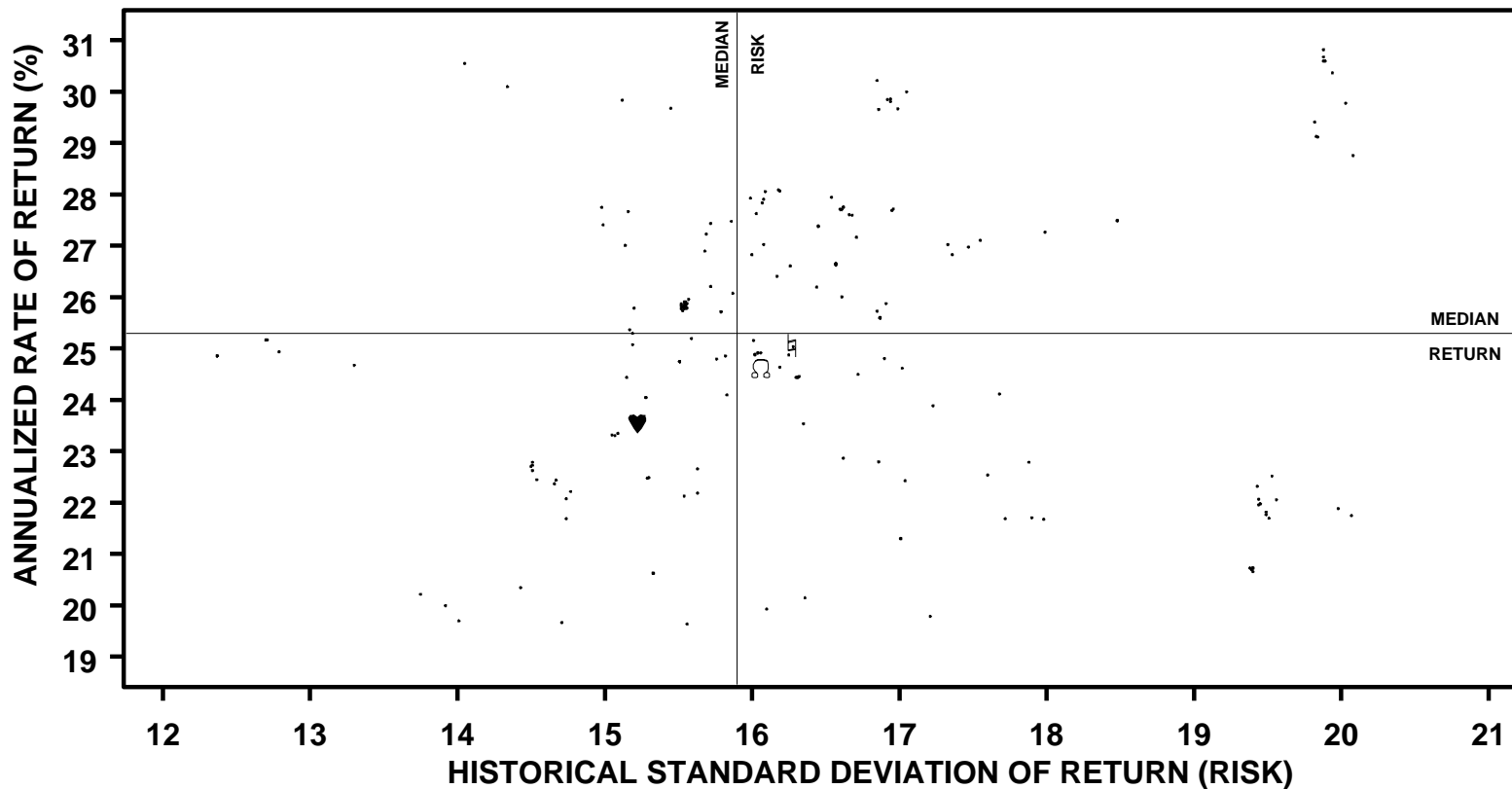

	ANNUALIZED RETURN		STANDARD DEVIATION		SHARPE RATIO	
	VALUE	RANK	VALUE	RANK	VALUE	RANK
♥ UBS	23.5	68	15.2	76	1.4	55
Ω MS EAFE NET	24.6	61	16.1	45	1.4	58
⚡ CITI PMI EPAC	25.1	52	16.3	40	1.4	55
MEDIAN	25.3		15.9		1.4	

VERMONT MUNICIPAL EMPLOYEES

INT'L DEVELOPED MKT EQUITY FUNDS - TOTAL RETURN VS RISK

5 YEARS ENDING 9/05

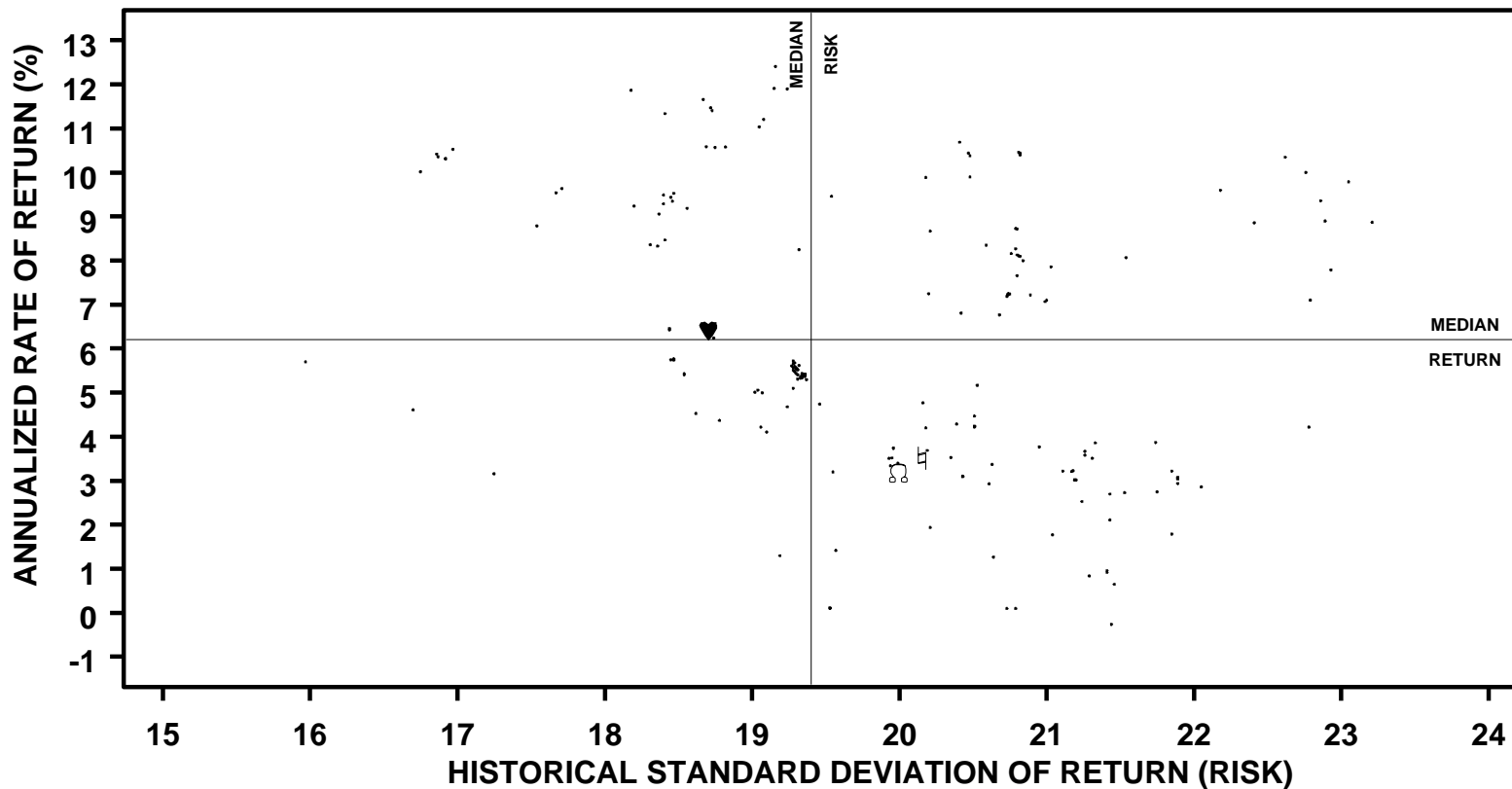

	ANNUALIZED RETURN		STANDARD DEVIATION		SHARPE RATIO	
	VALUE	RANK	VALUE	RANK	VALUE	RANK
♥ UBS	6.4	49	18.7	70	0.3	49
Ω MS EAFE NET	3.2	78	20.0	42	0.1	78
□ CITI PMI EPAC	3.5	74	20.2	41	0.2	74
MEDIAN	6.2		19.4		0.3	

VERMONT MUNICIPAL EMPLOYEES

INTERNATIONAL EQUITY ONLY - RATES OF RETURN

PERIODS ENDING 9/05

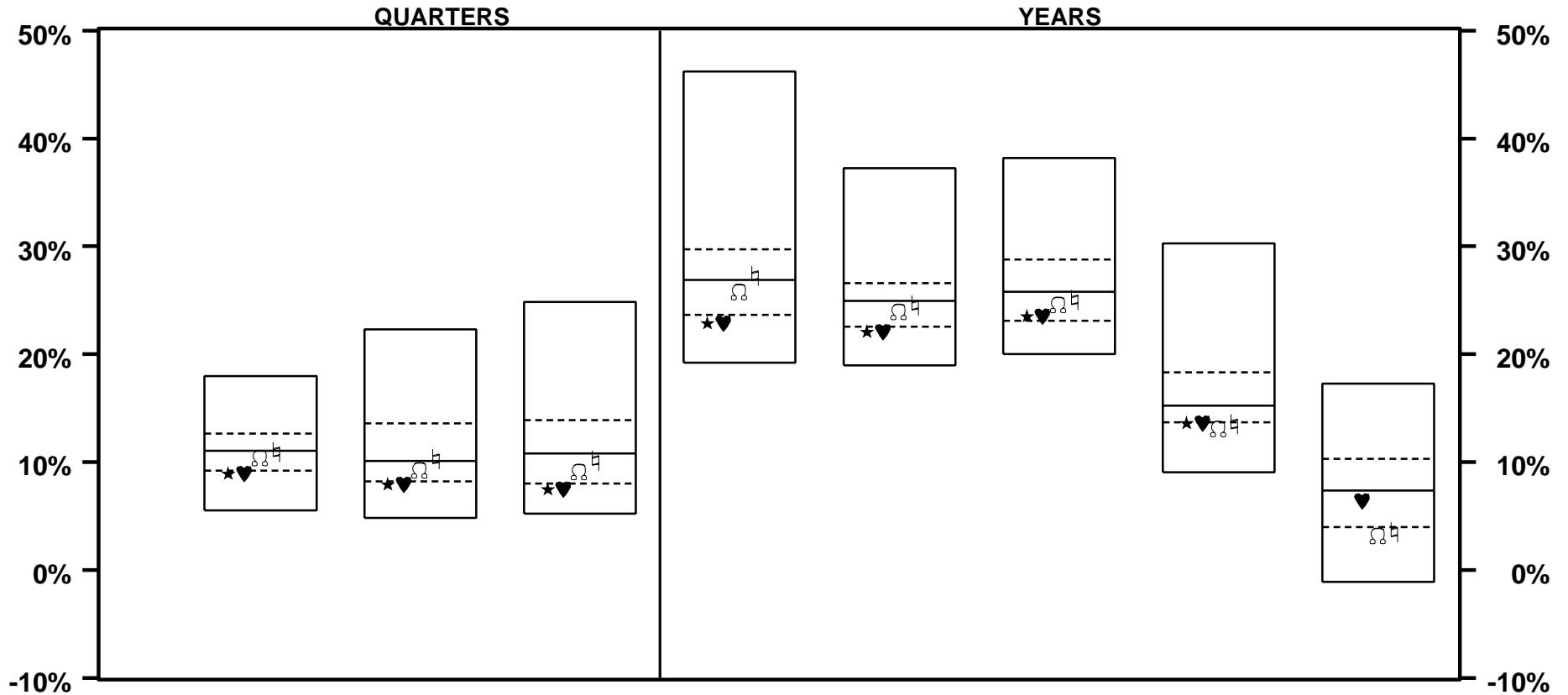

	LAST QTR		LAST 2 QTRS		LAST 3 QTRS		LAST YEAR		LAST 2 YEARS		LAST 3 YEARS		LAST 4 YEARS		LAST 5 YEARS	
★ MUNI COMPOSITE	9.0	77	7.9	77	7.5	78	22.9	78	22.1	79	23.5	72	13.6	75		
♥ UBS	9.0	77	7.9	77	7.5	78	22.9	78	22.1	79	23.5	72	13.6	75	6.4	53
Ω MS EAFE NET	10.4	58	9.3	61	9.1	68	25.8	62	23.9	57	24.6	66	13.1	81	3.2	81
□ CITI PMI EPAC	11.0	51	10.3	49	10.2	56	27.3	47	24.5	52	25.1	58	13.5	76	3.5	77
MEDIAN	11.0		10.1		10.8		26.9		24.9		25.8		15.3		7.4	

VERMONT MUNICIPAL EMPLOYEES

INTERNATIONAL EQUITY ONLY - RATES OF RETURN

PERIODS ENDING 9/05

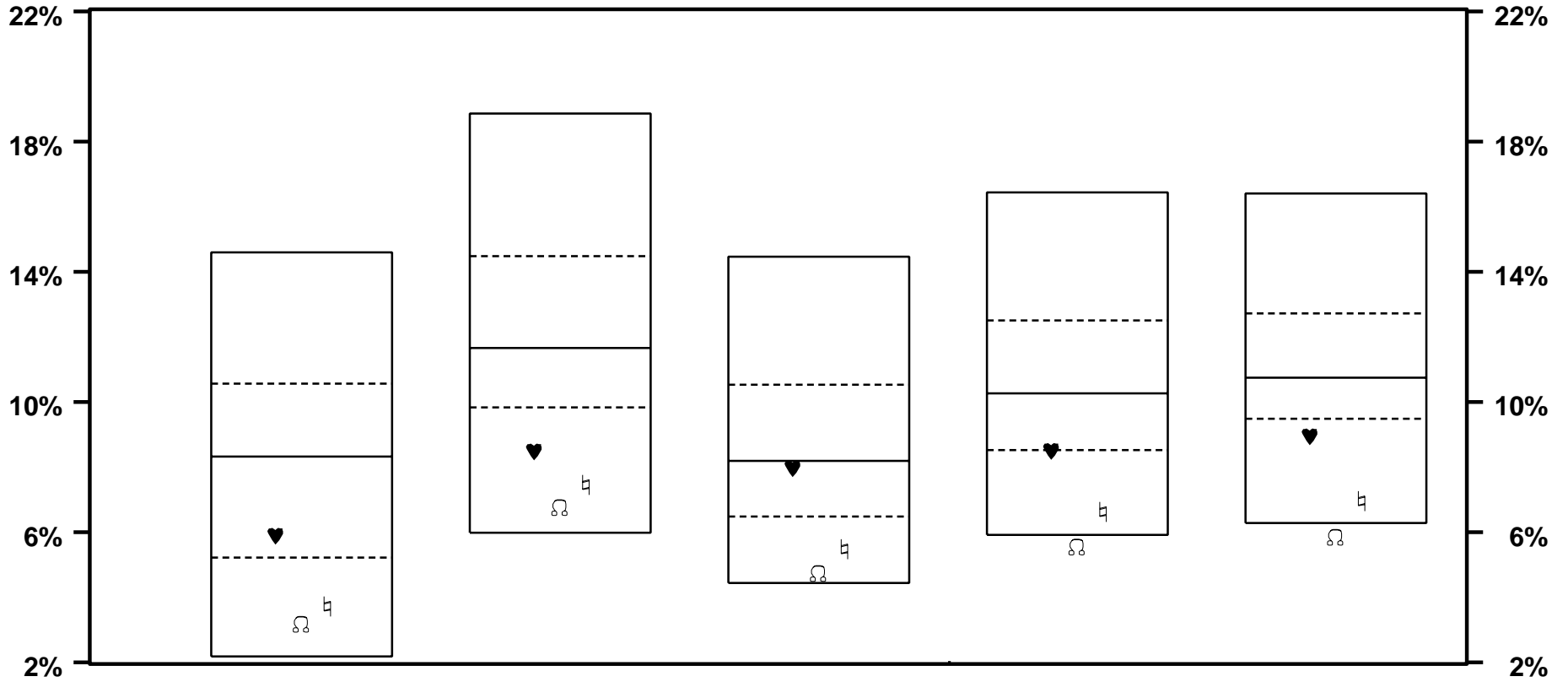

	LAST 6 YEARS		LAST 7 YEARS		LAST 8 YEARS		LAST 9 YEARS		LAST 10 YEARS	
♥ UBS	5.9	71	8.5	81	8.0	55	8.5	77	9.0	76
○ MS EAFE NET	3.2	90	6.8	92	4.7	93	5.5	96	5.8	98
□ CITI PMI EPAC	3.7	85	7.5	87	5.5	86	6.6	90	7.0	90
MEDIAN	8.3		11.7		8.2		10.3		10.7	

VERMONT MUNICIPAL EMPLOYEES

INTERNATIONAL EQUITY ONLY - RATES OF RETURN

YEARS ENDING

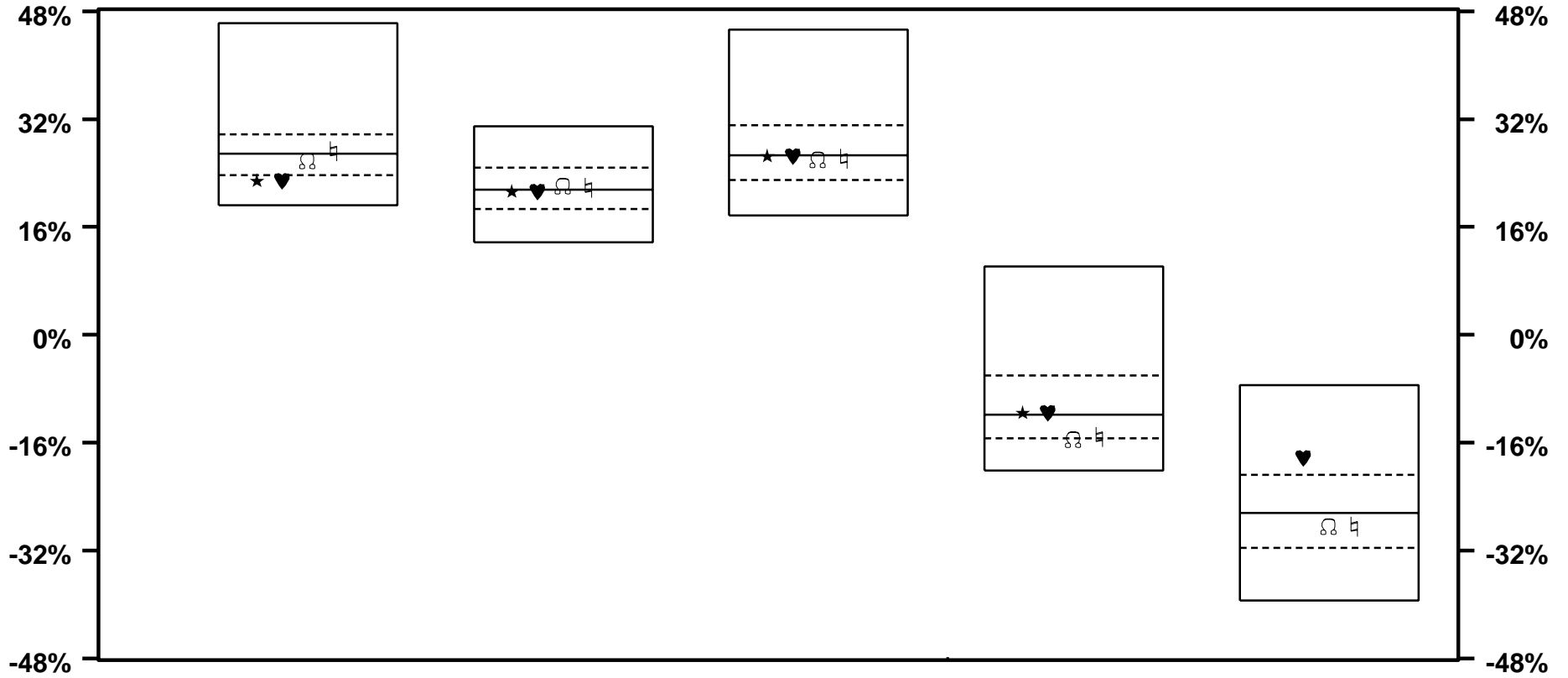

	9 / 05		9 / 04		9 / 03		9 / 02		9 / 01	
★ MUNI COMPOSITE	22.9	78	21.3	56	26.5	51	-11.6	43		
♥ UBS	22.9	78	21.3	56	26.5	51	-11.6	43	-18.2	18
⊙ MS EAFE NET	25.8	62	22.1	47	26.0	55	-15.5	76	-28.5	62
⊠ CITI PMI EPAC	27.3	47	21.9	48	26.1	54	-15.1	71	-28.4	62
MEDIAN	26.9		21.5		26.7		-11.8		-26.4	

VERMONT MUNICIPAL EMPLOYEES

INTERNATIONAL EQUITY ONLY - RATES OF RETURN

YEARS ENDING

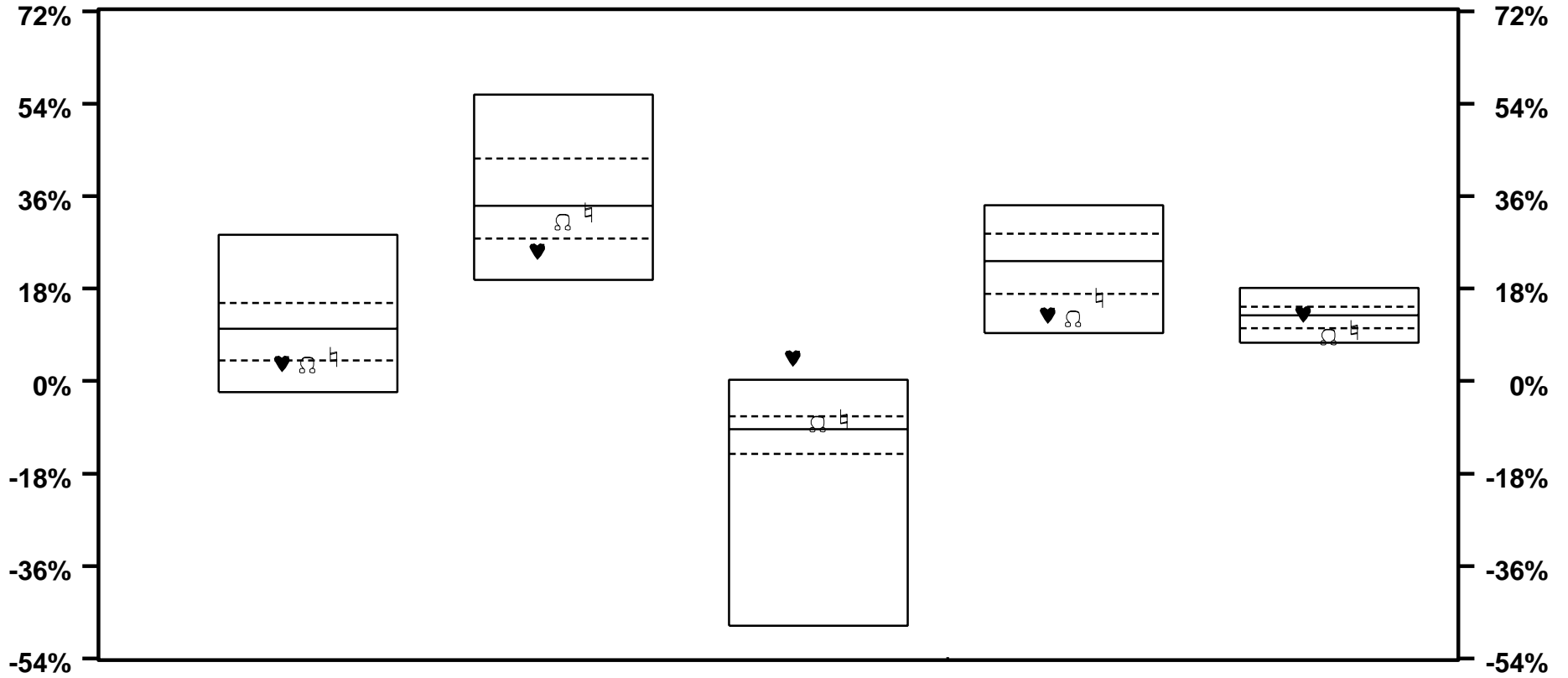

	9 / 00		9 / 99		9 / 98		9 / 97		9 / 96	
♥ UBS	3.4	78	25.3	83	4.5	1	12.8	89	13.1	45
○ MS EAFE NET	3.2	79	31.0	62	-8.3	36	12.2	90	8.6	88
□ CITI PMI EPAC	4.8	72	32.9	53	-7.4	29	16.3	78	10.0	77
MEDIAN	10.2		34.1		-9.3		23.3		12.8	

VERMONT MUNICIPAL EMPLOYEES

PRIVATE INVESTMENT FUNDS - TOTAL RATES OF RETURN

PERIODS ENDING 9/05

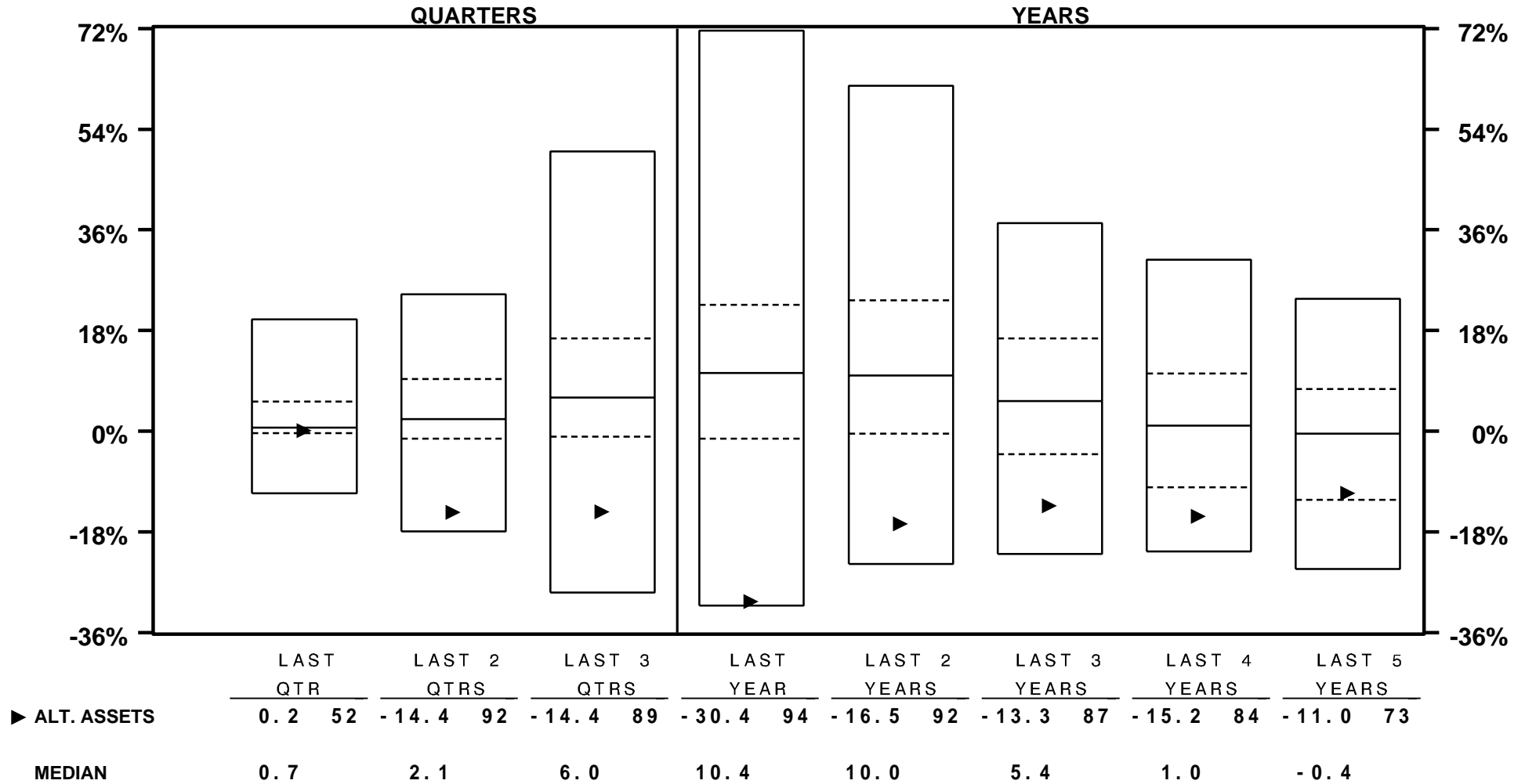

VERMONT MUNICIPAL EMPLOYEES

PRIVATE INVESTMENT FUNDS - TOTAL RATES OF RETURN

PERIODS ENDING 9/05

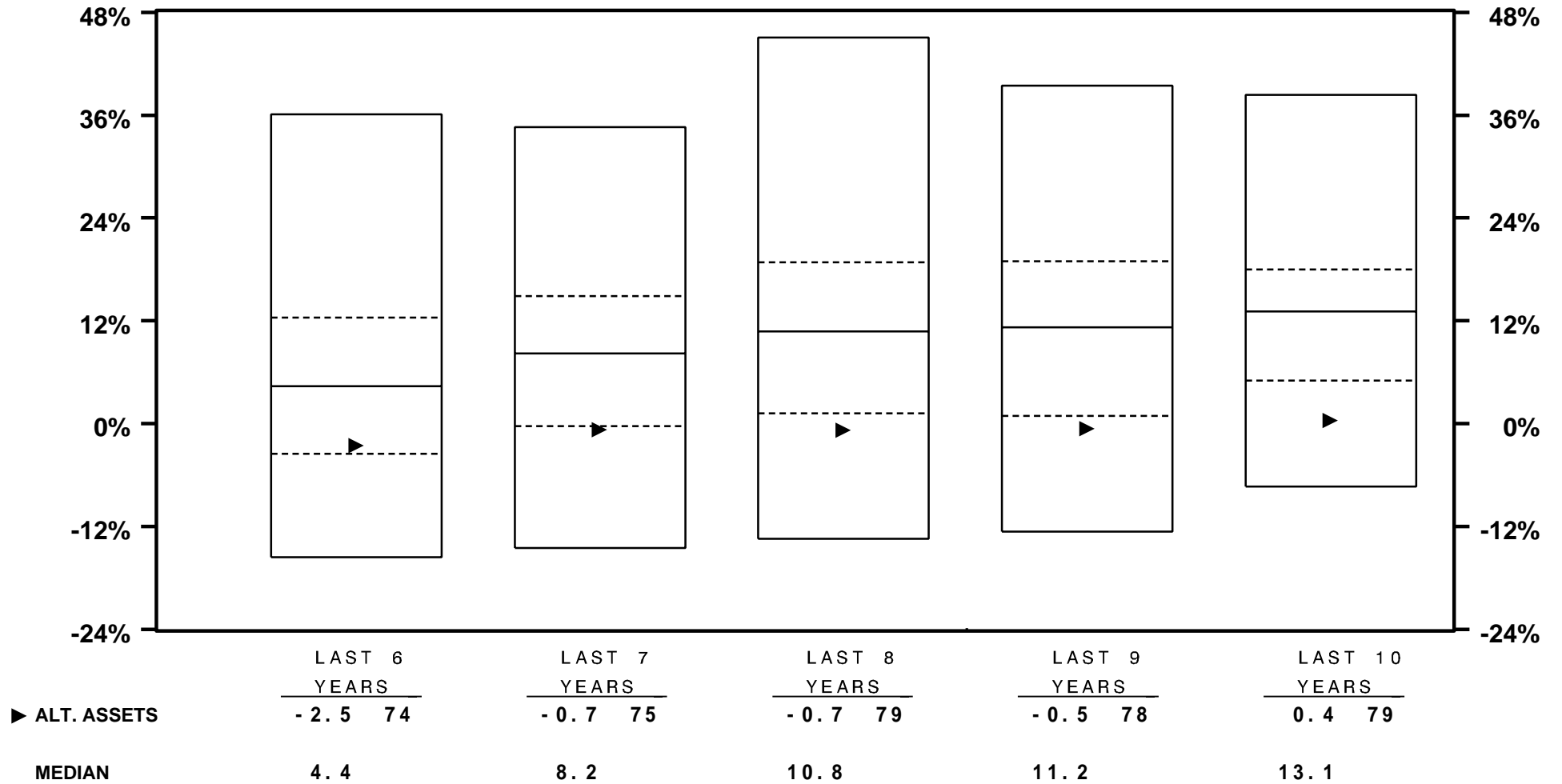

VERMONT MUNICIPAL EMPLOYEES

PRIVATE INVESTMENT FUNDS - TOTAL RATES OF RETURN

YEARS ENDING

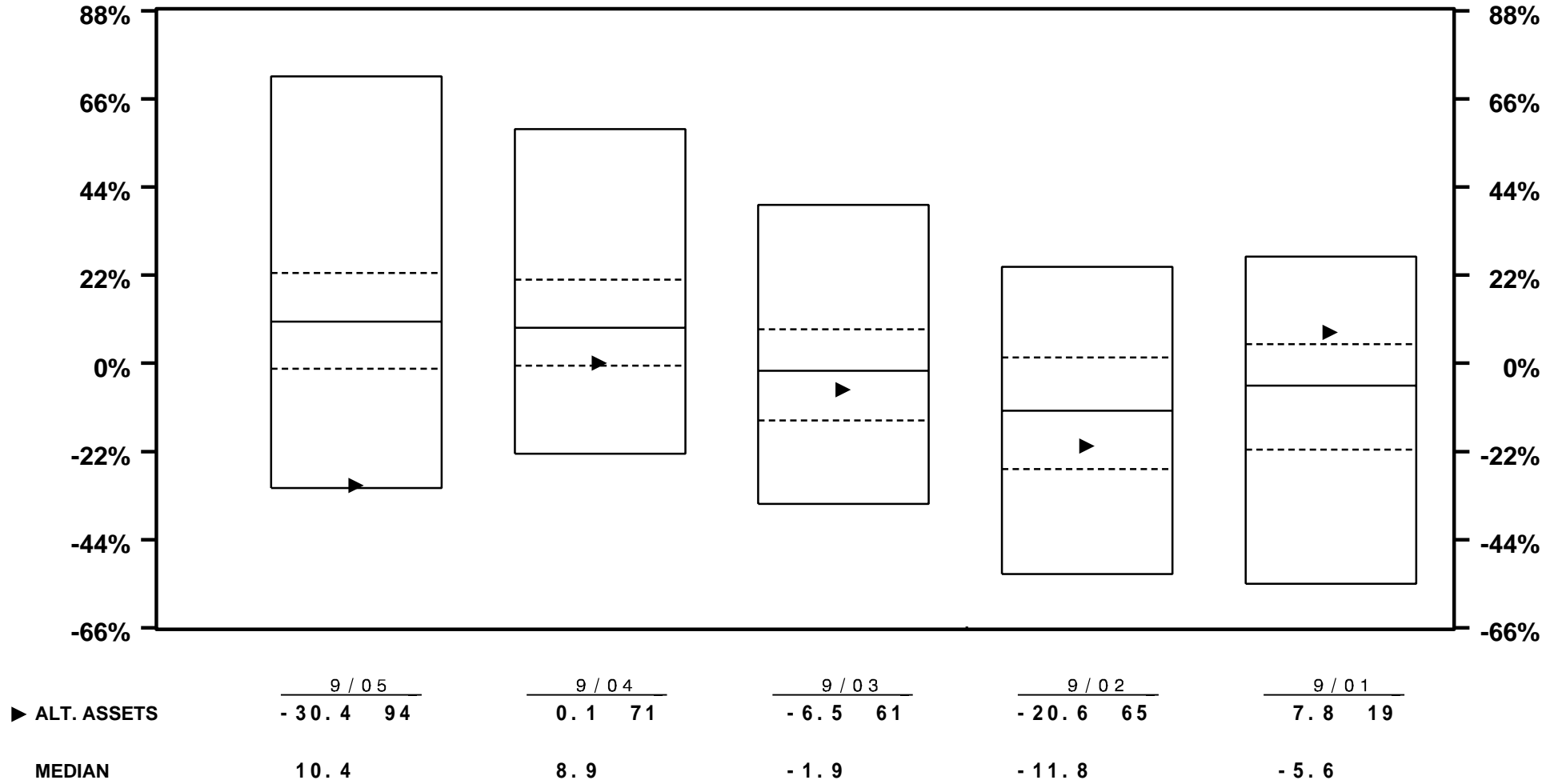

VERMONT MUNICIPAL EMPLOYEES

PRIVATE INVESTMENT FUNDS - TOTAL RATES OF RETURN

YEARS ENDING

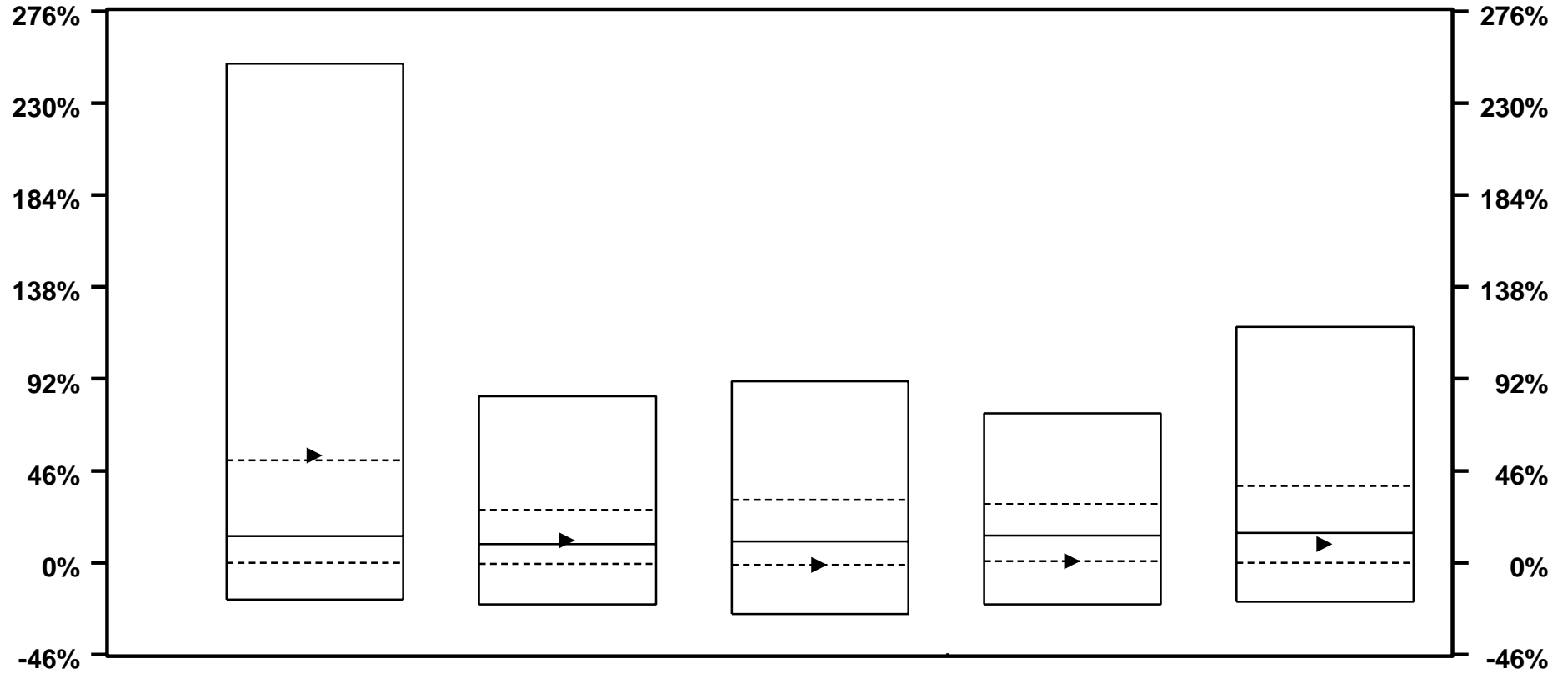

	9 / 00	9 / 99	9 / 98	9 / 97	9 / 96
▶ ALT. ASSETS	53.8 23	11.2 46	-0.9 74	1.0 74	9.5 58
MEDIAN	13.2	9.2	10.5	13.5	14.7

VERMONT MUNICIPAL EMPLOYEES

PRIVATE INVESTMENT FUNDS - TOTAL RETURN VS RISK

3 YEARS ENDING 9/05

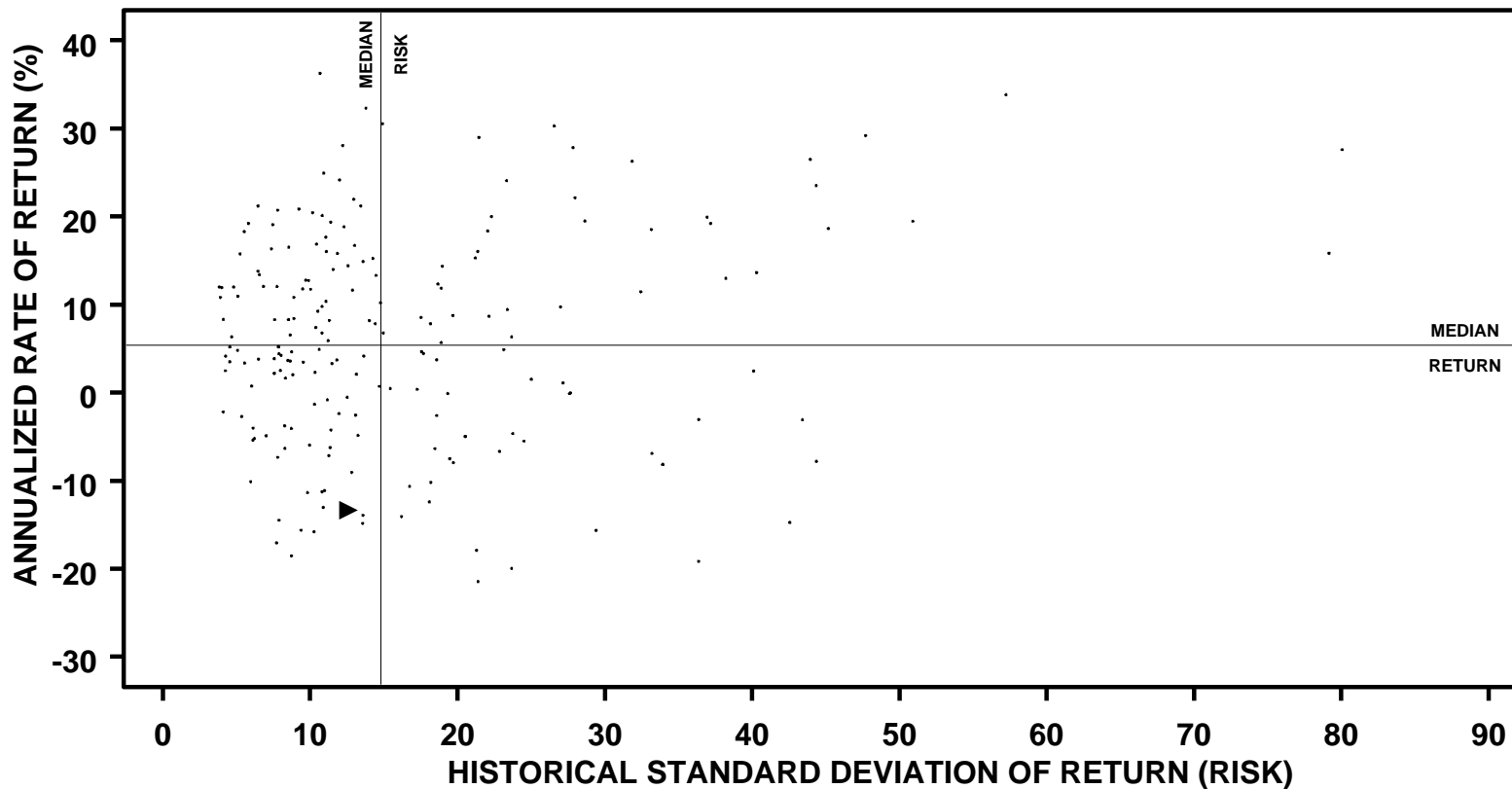

	ANNUALIZED RETURN		STANDARD DEVIATION		SHARPE RATIO	
	VALUE	RANK	VALUE	RANK	VALUE	RANK
▶ ALT. ASSETS	- 13.3	87	12.6	57	- 1.2	
MEDIAN	5.4		14.8		0.4	

VERMONT MUNICIPAL EMPLOYEES
PRIVATE INVESTMENT FUNDS - TOTAL RETURN VS RISK
5 YEARS ENDING 9/05

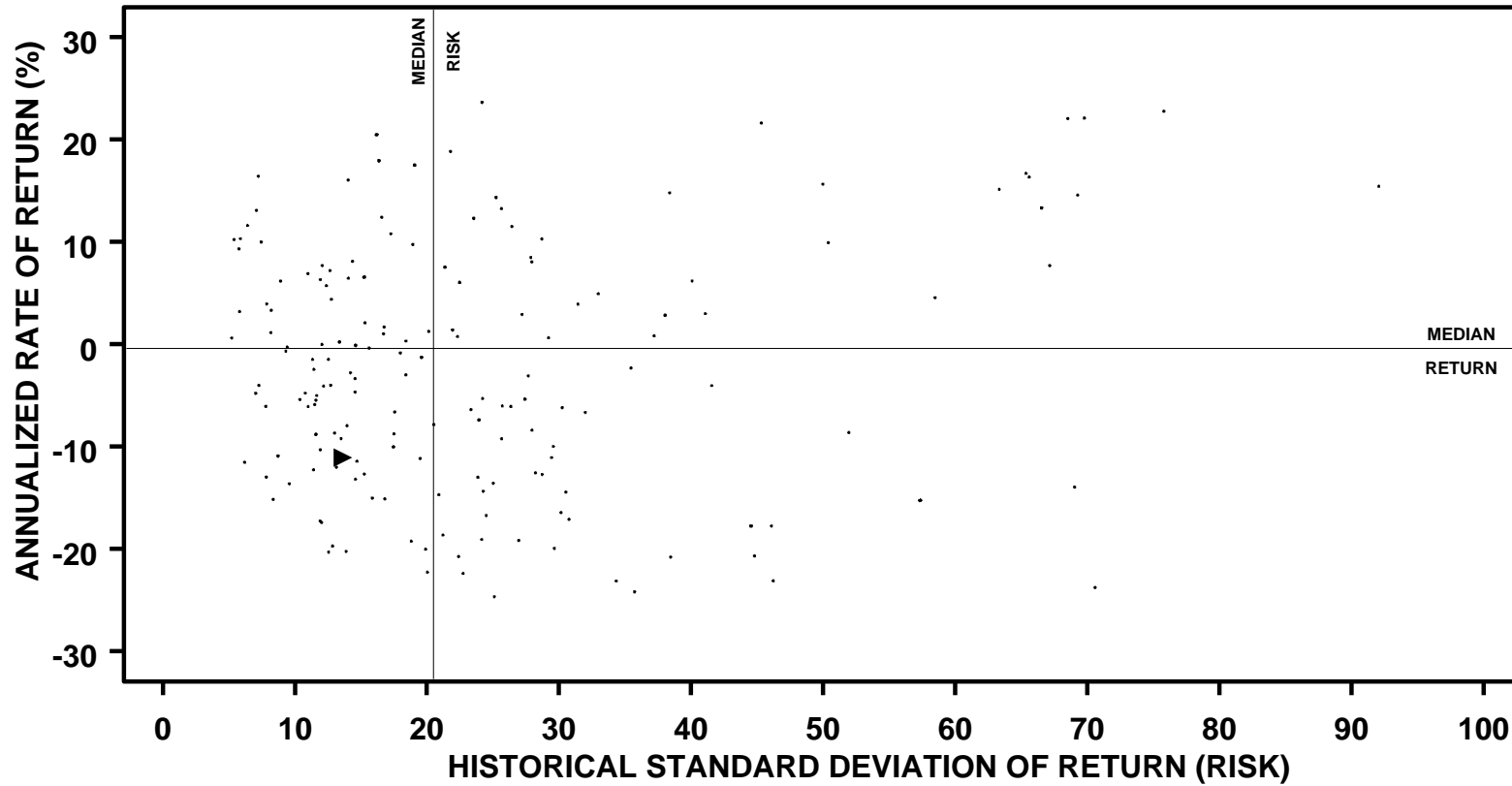

	ANNUALIZED RETURN		STANDARD DEVIATION		SHARPE RATIO	
	VALUE	RANK	VALUE	RANK	VALUE	RANK
▶ ALT. ASSETS	- 11.0	73	13.7	69	- 0.9	
MEDIAN	- 0.4		20.5		- 0.1	

VERMONT MUNICIPAL EMPLOYEES

PRIVATE INVESTMENTS ONLY - TOTAL RATES OF RETURN

PERIODS ENDING 9/05

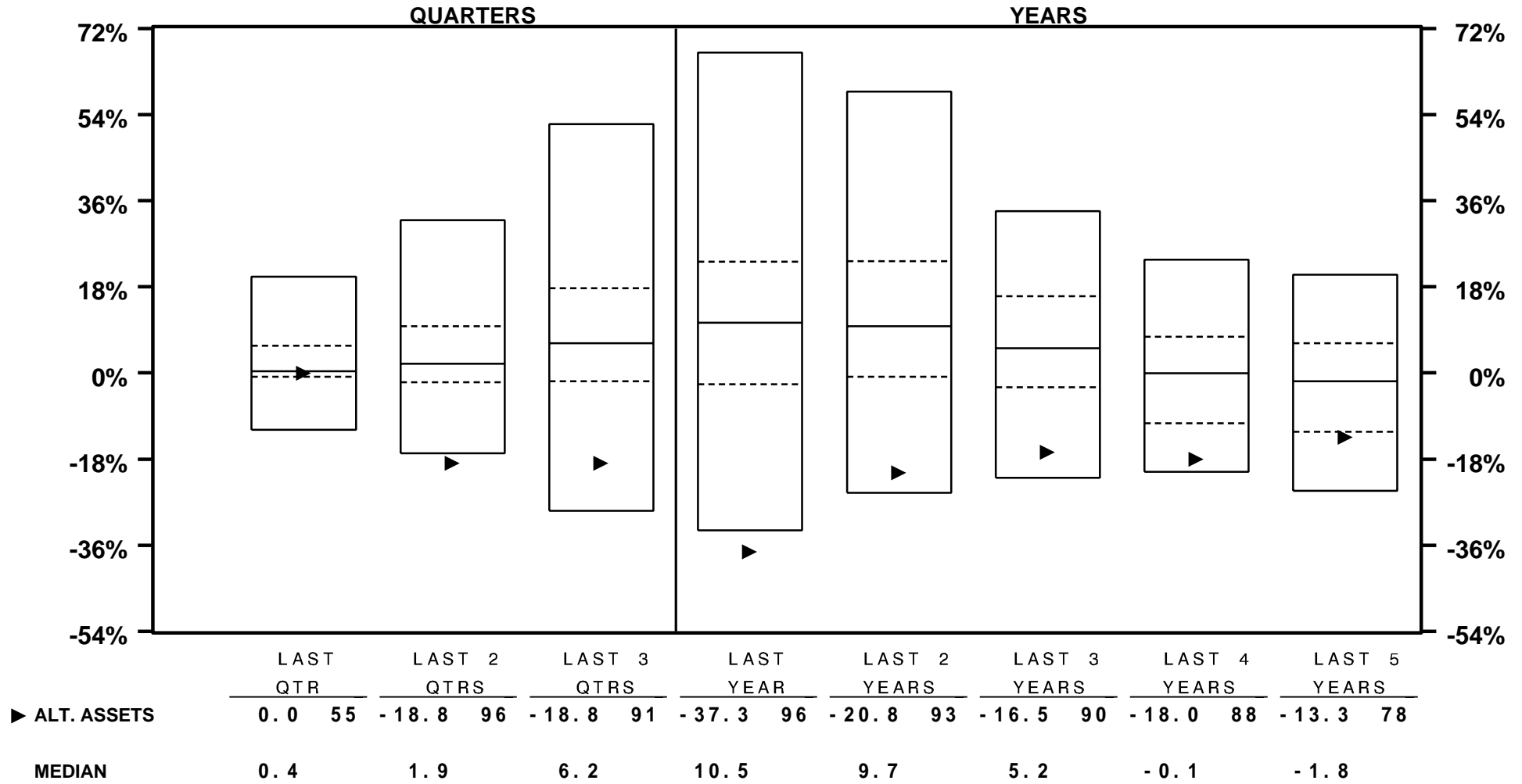

VERMONT MUNICIPAL EMPLOYEES

PRIVATE INVESTMENTS ONLY - TOTAL RATES OF RETURN

PERIODS ENDING 9/05

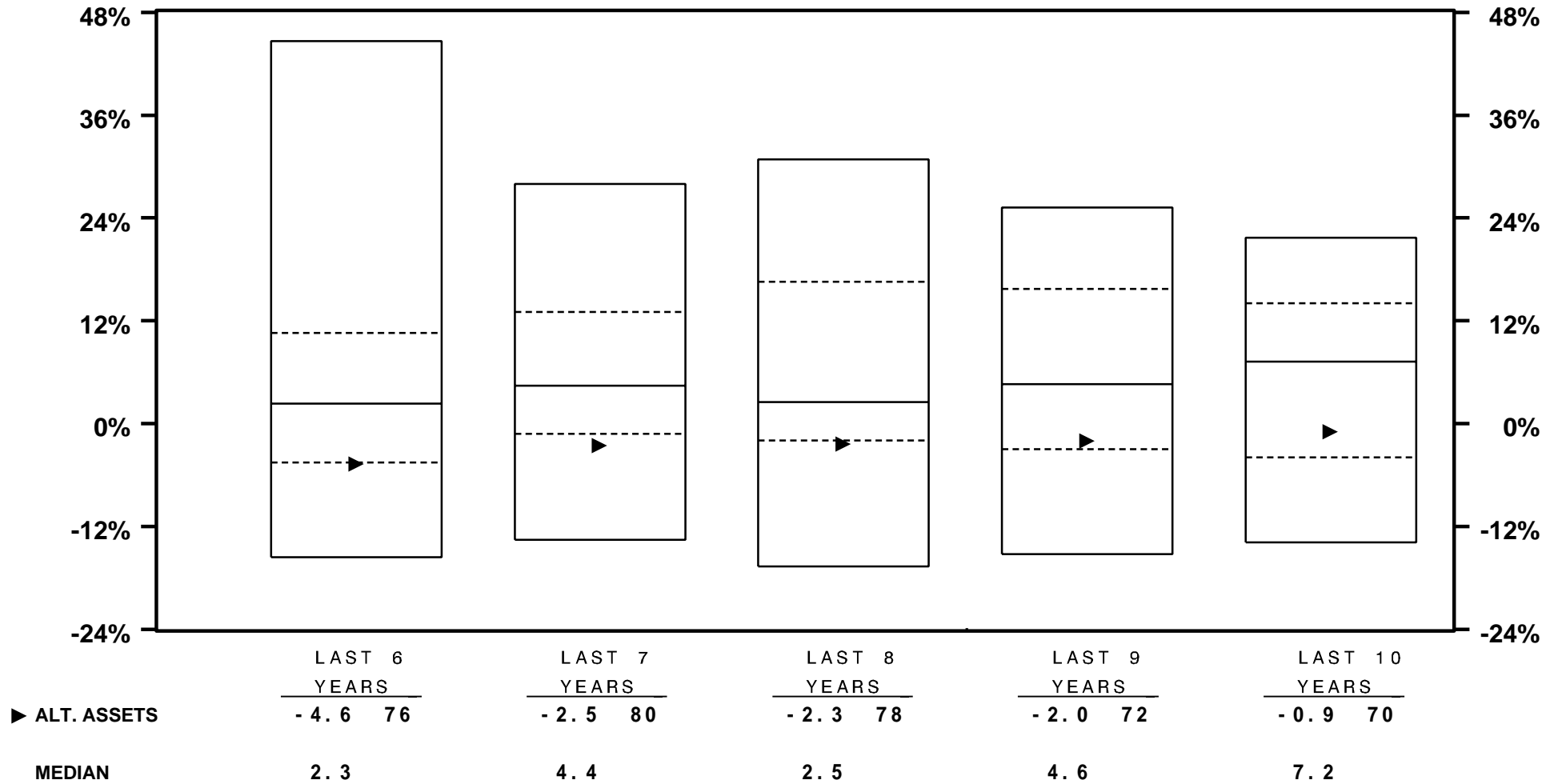

VERMONT MUNICIPAL EMPLOYEES

PRIVATE INVESTMENTS ONLY - TOTAL RATES OF RETURN

YEARS ENDING

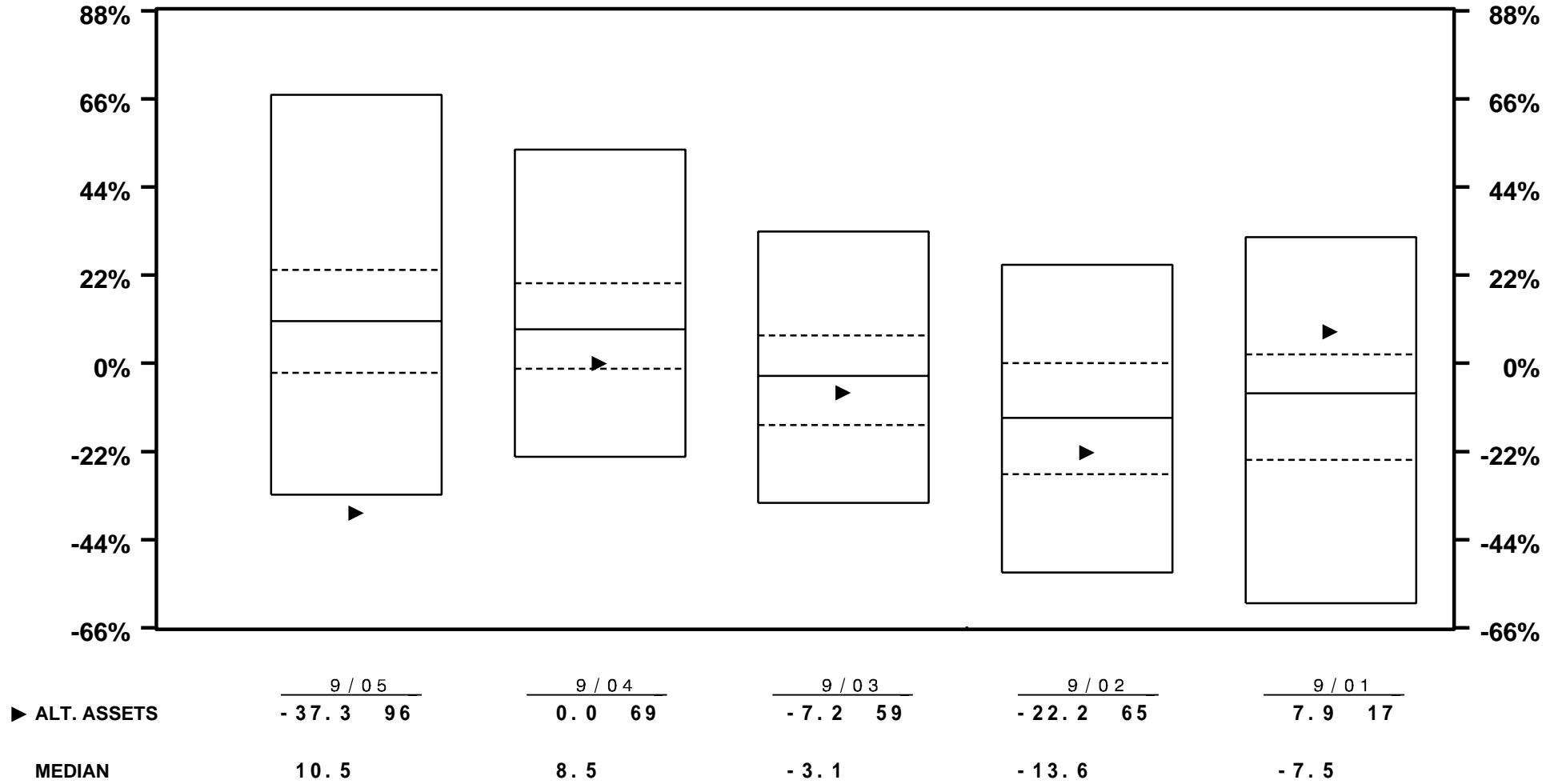

VERMONT MUNICIPAL EMPLOYEES

PRIVATE INVESTMENTS ONLY - TOTAL RATES OF RETURN

YEARS ENDING

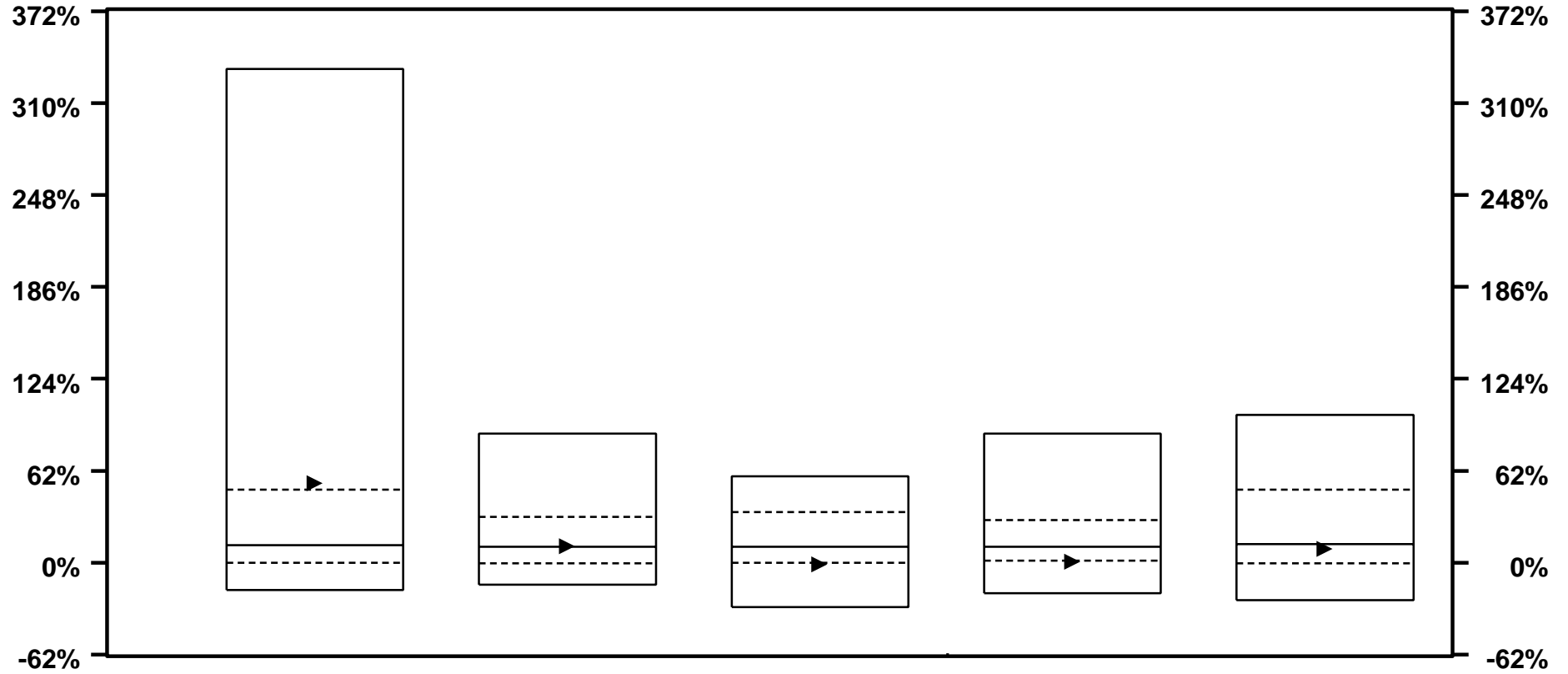

	9 / 00	9 / 99	9 / 98	9 / 97	9 / 96
▶ ALT. ASSETS	53.8 22	11.2 48	-0.9 82	1.0 76	9.5 51
MEDIAN	11.8	10.7	10.9	10.6	12.7

VERMONT MUNICIPAL EMPLOYEES
PRIVATE INVESTMENTS ONLY - TOTAL RETURN VS RISK
3 YEARS ENDING 9/05

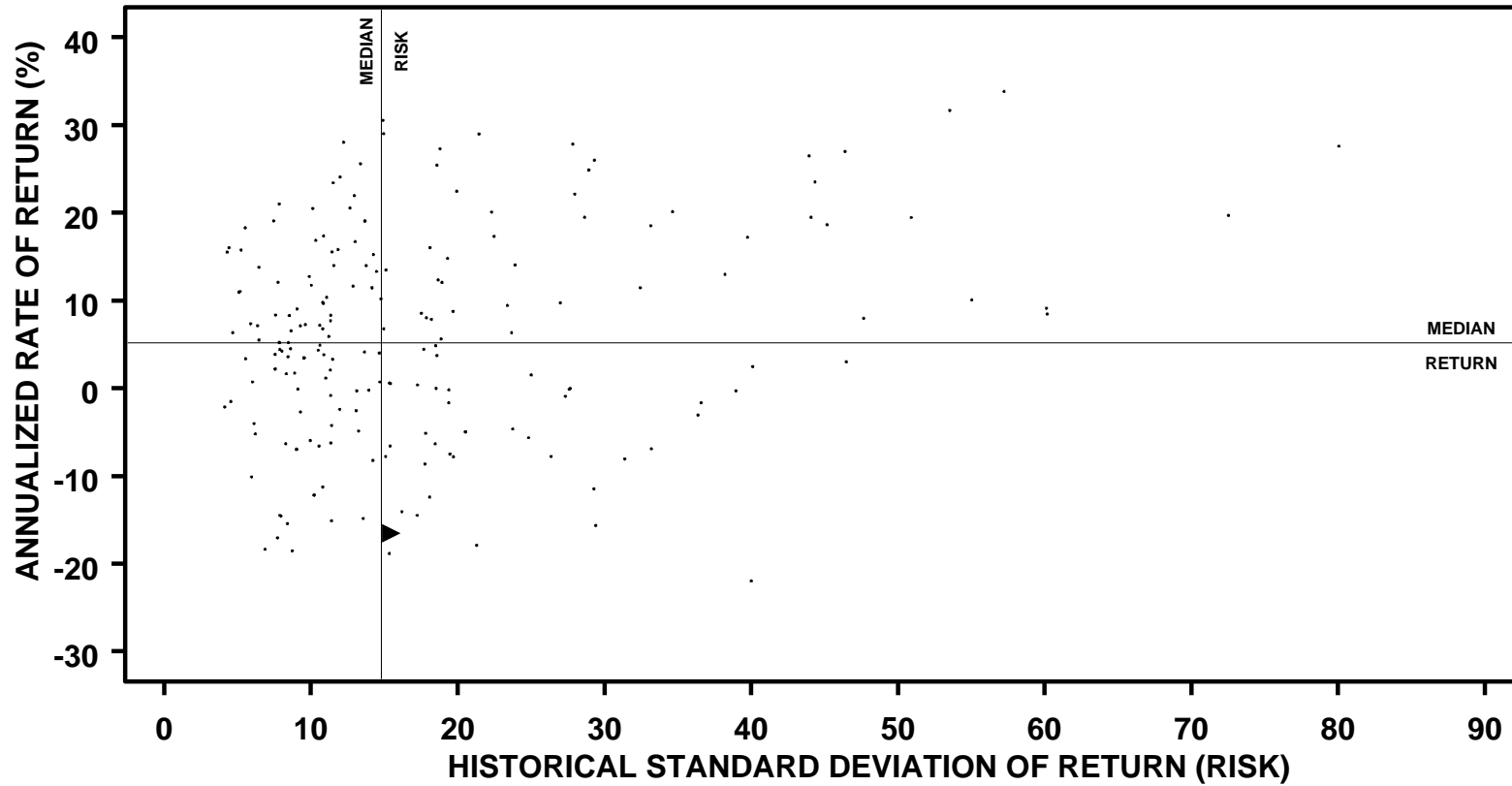

	ANNUALIZED RETURN		STANDARD DEVIATION		SHARPE RATIO	
	VALUE	RANK	VALUE	RANK	VALUE	RANK
▶ ALT. ASSETS	- 16.5	90	15.5	46	- 1.2	
MEDIAN	5.2		14.8		0.4	

VERMONT MUNICIPAL EMPLOYEES

PRIVATE INVESTMENTS ONLY - TOTAL RETURN VS RISK

5 YEARS ENDING 9/05

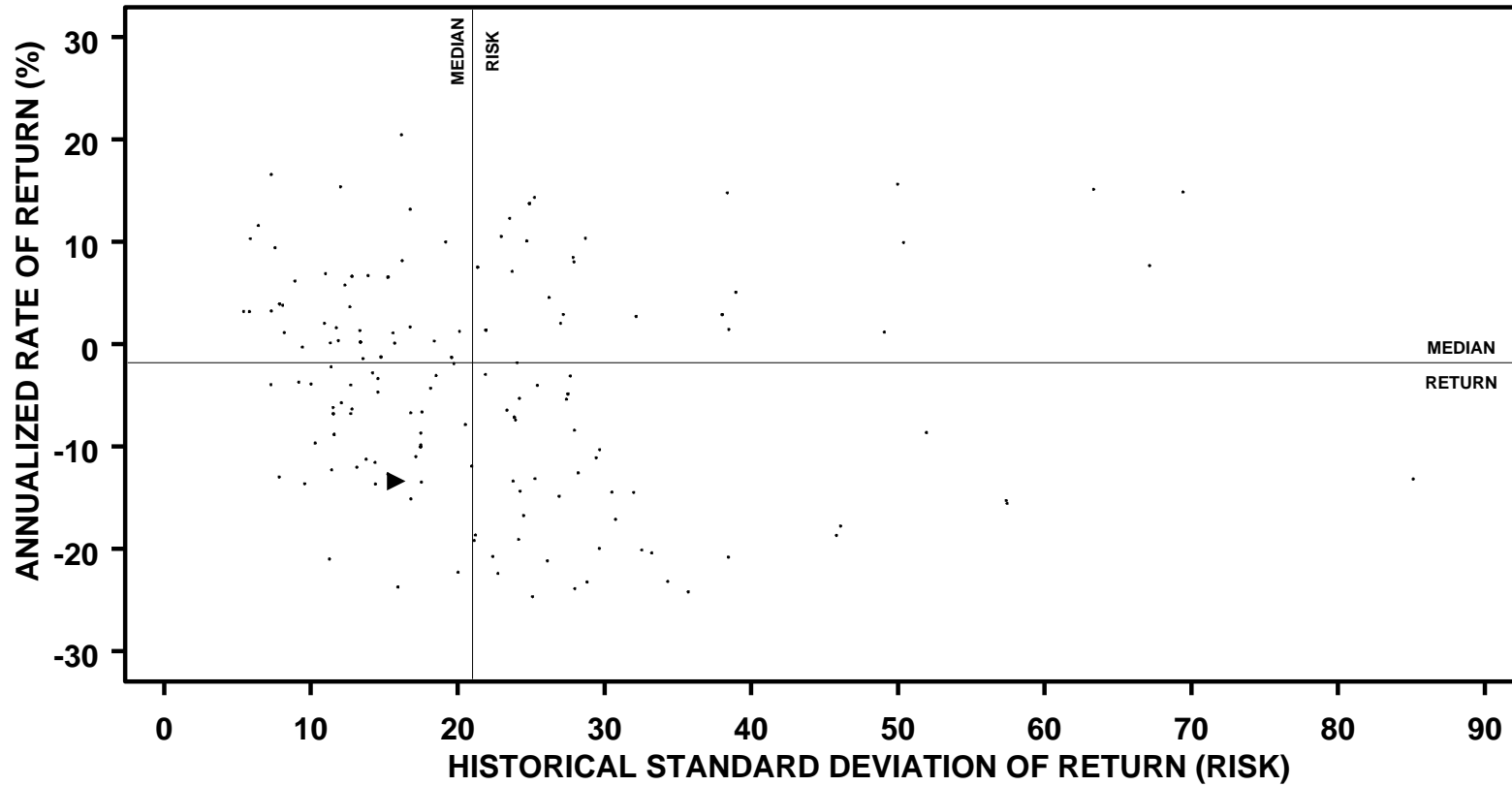

	ANNUALIZED RETURN		STANDARD DEVIATION		SHARPE RATIO	
	VALUE	RANK	VALUE	RANK	VALUE	RANK
▶ ALT. ASSETS	- 13.3	78	15.8	63	- 1.0	
MEDIAN	- 1.8		21.0		- 0.1	

VERMONT MUNICIPAL EMPLOYEES

PRIVATE EQUITY FUNDS - TOTAL RATES OF RETURN

PERIODS ENDING 9/05

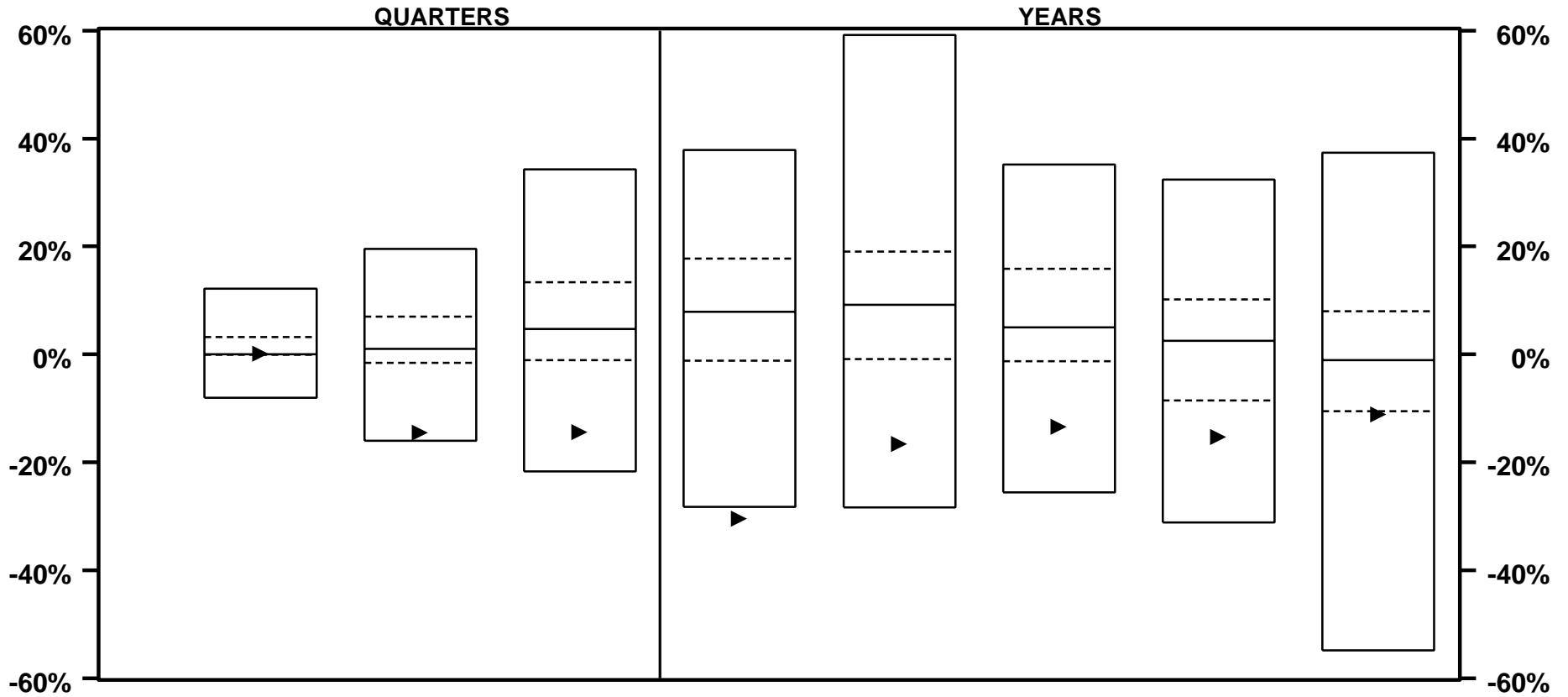

	LAST QTR		LAST 2 QTRS		LAST 3 QTRS		LAST YEAR		LAST 2 YEARS		LAST 3 YEARS		LAST 4 YEARS		LAST 5 YEARS	
▶ ALT. ASSETS	0.2	45	-14.4	93	-14.4	92	-30.4	95	-16.5	90	-13.3	88	-15.2	84	-11.0	77
MEDIAN	0.0		1.1		4.7		7.9		9.2		5.0		2.5		-1.1	

VERMONT MUNICIPAL EMPLOYEES

PRIVATE EQUITY FUNDS - TOTAL RATES OF RETURN

PERIODS ENDING 9/05

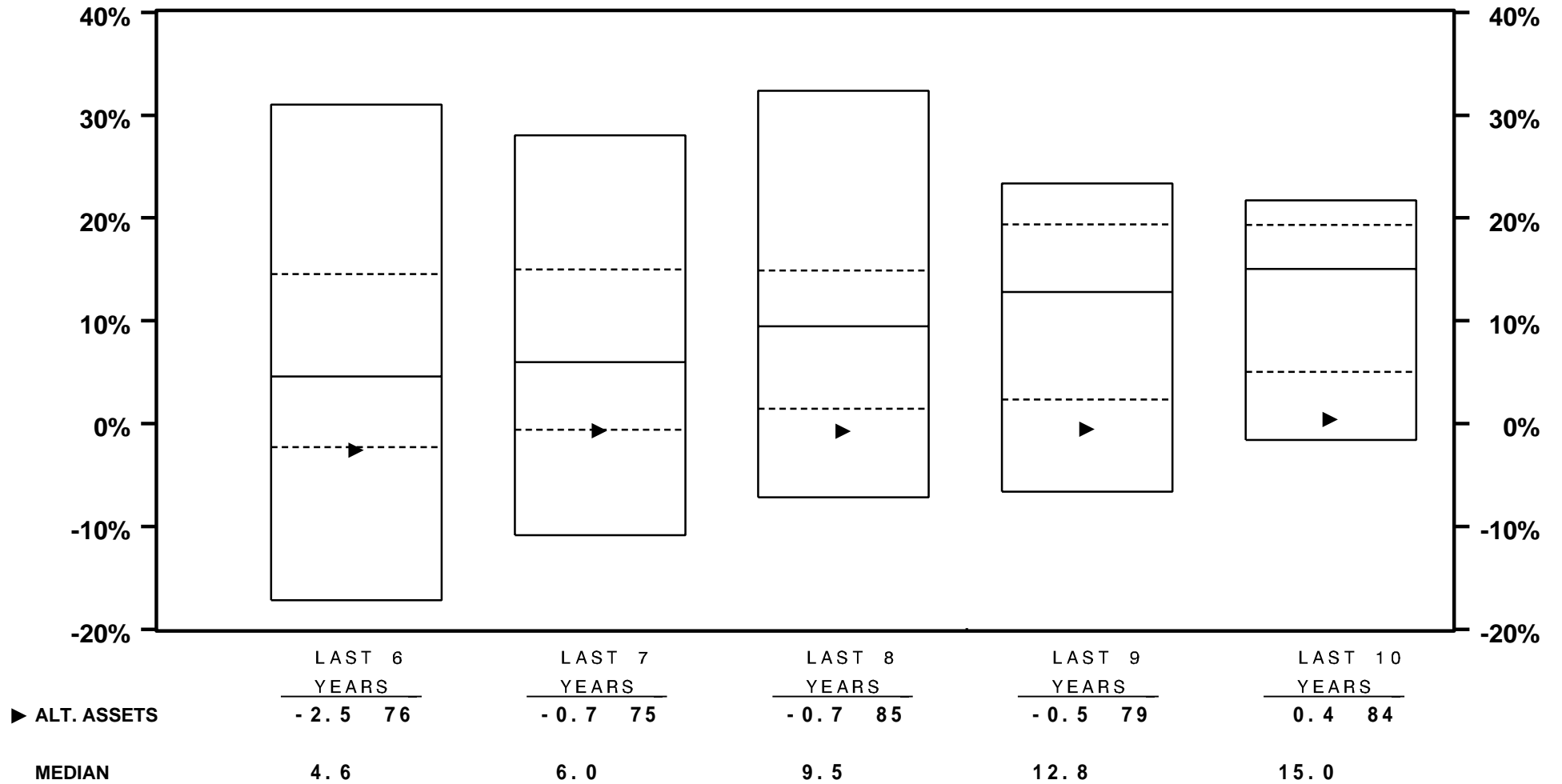

VERMONT MUNICIPAL EMPLOYEES

PRIVATE EQUITY FUNDS - TOTAL RATES OF RETURN

YEARS ENDING

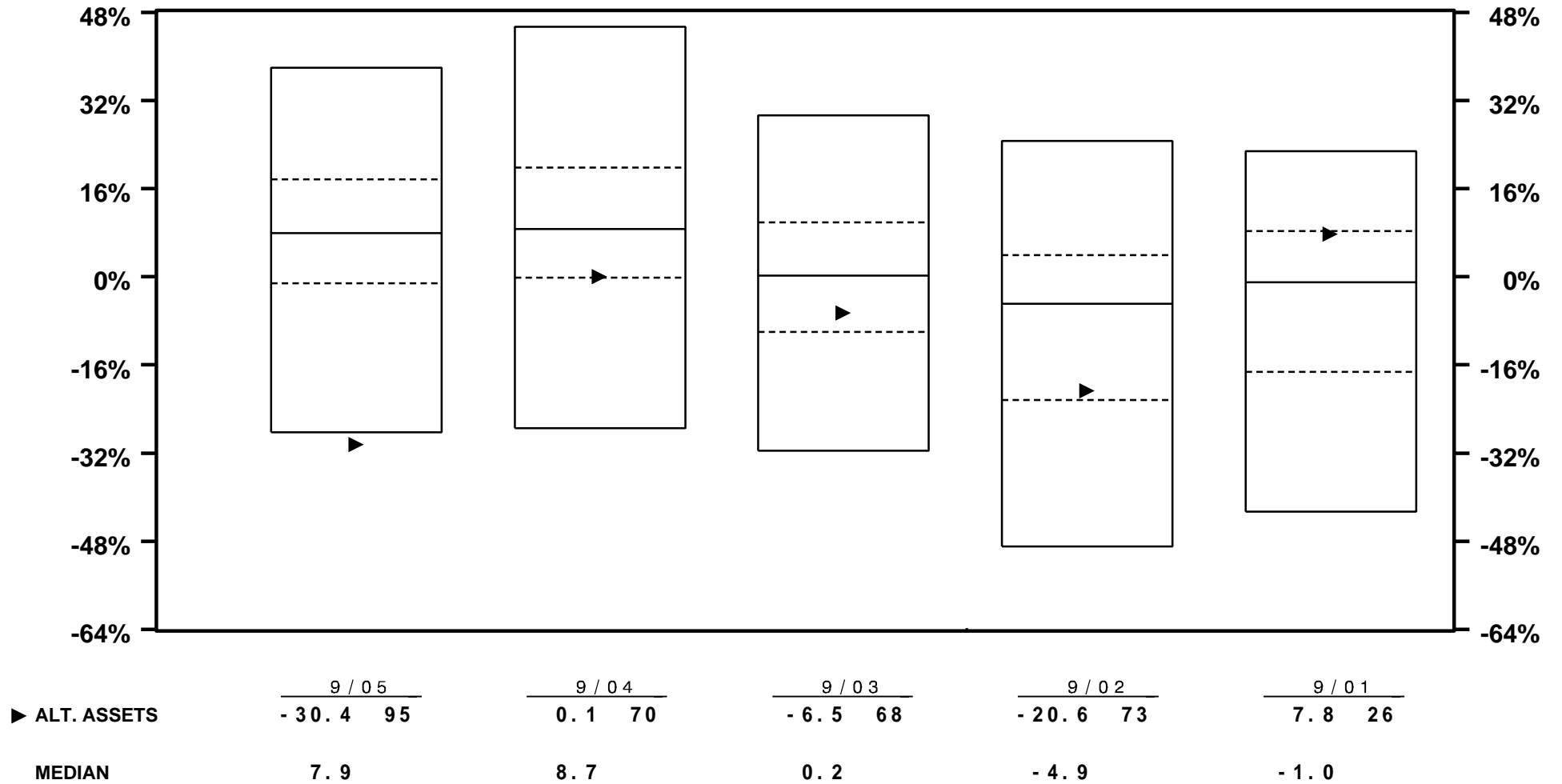

VERMONT MUNICIPAL EMPLOYEES

PRIVATE EQUITY FUNDS - TOTAL RATES OF RETURN

YEARS ENDING

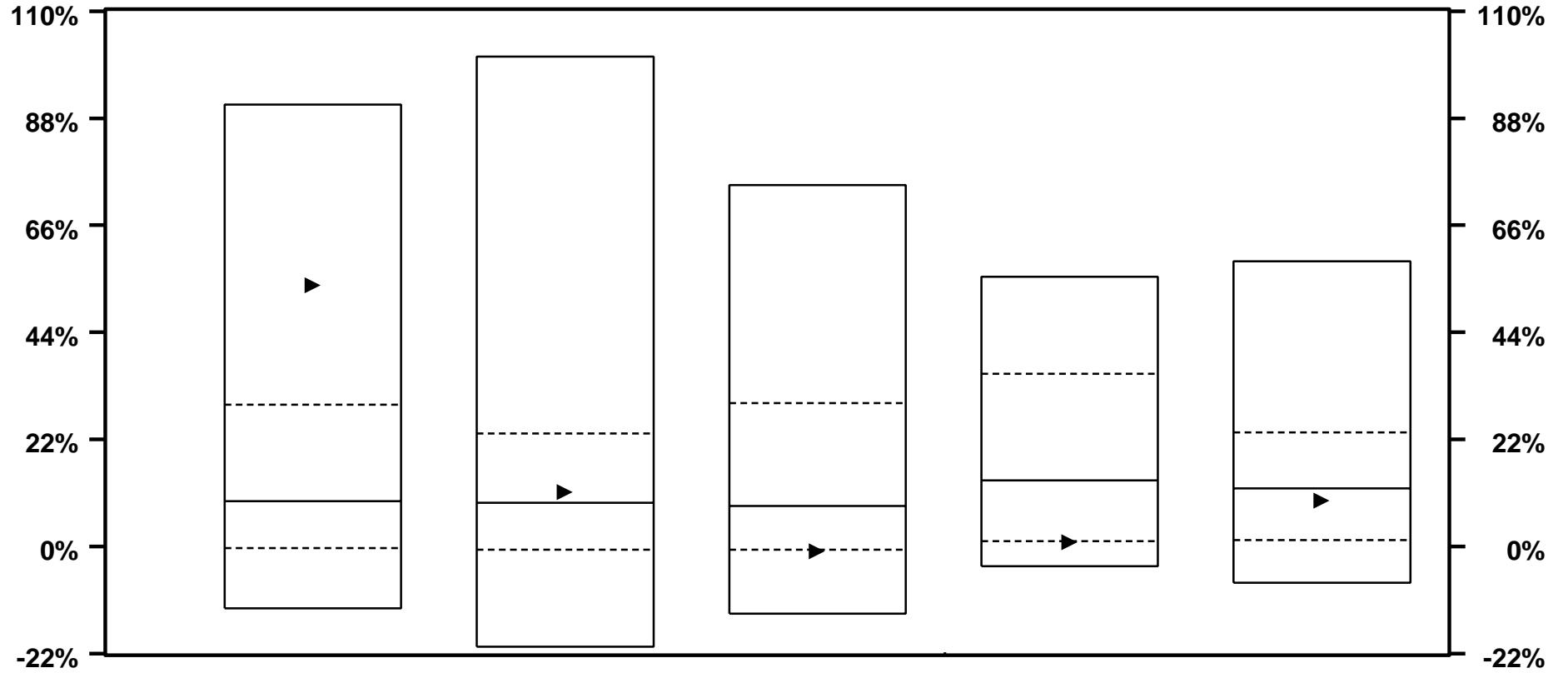

	9 / 00	9 / 99	9 / 98	9 / 97	9 / 96
▶ ALT. ASSETS	53.8 11	11.2 47	- 0.9 76	1.0 75	9.5 56
MEDIAN	9.3	9.0	8.3	13.5	11.9

VERMONT MUNICIPAL EMPLOYEES

PRIVATE EQUITY FUNDS - TOTAL RETURN VS RISK

3 YEARS ENDING 9/05

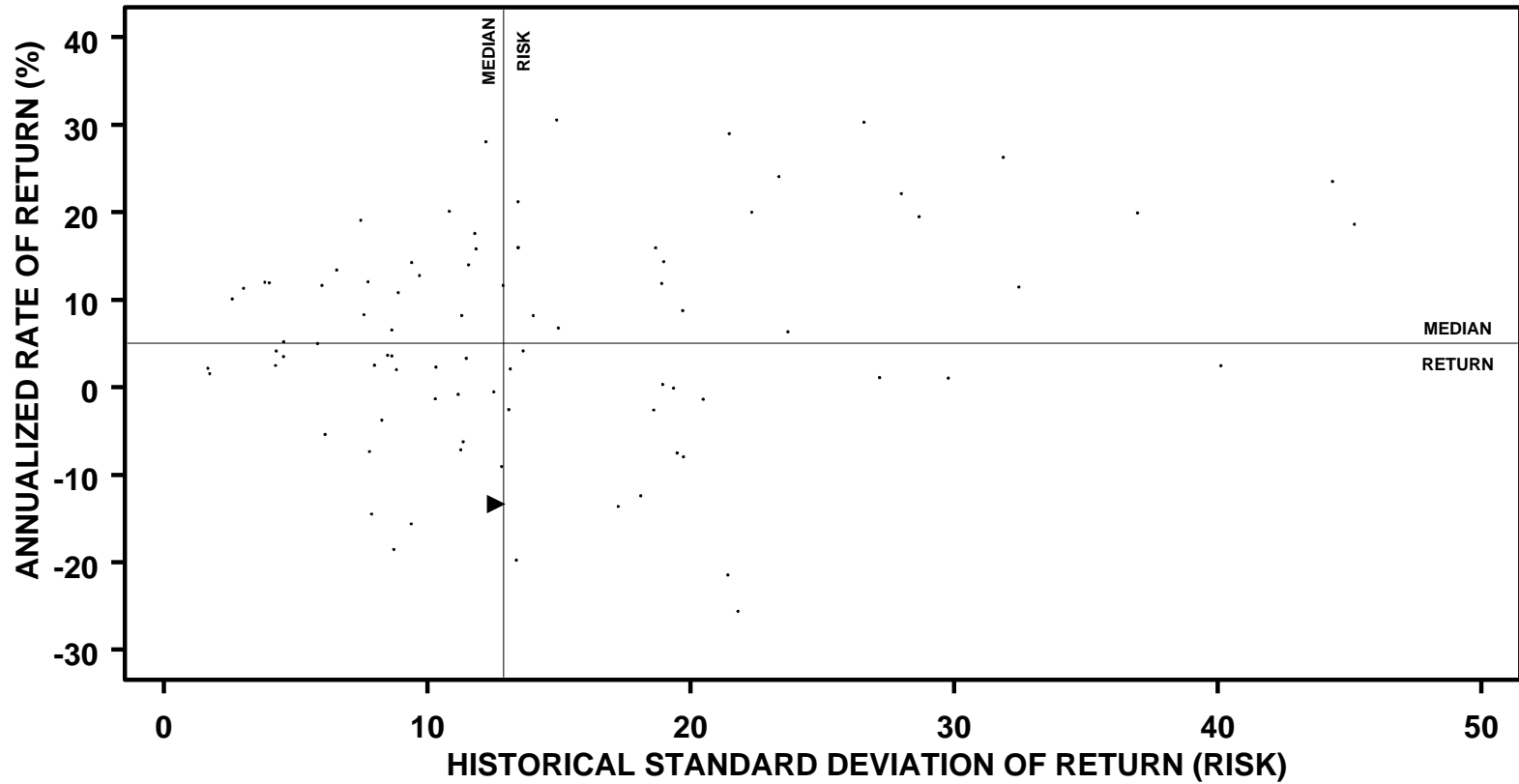

	ANNUALIZED RETURN		STANDARD DEVIATION		SHARPE RATIO	
	VALUE	RANK	VALUE	RANK	VALUE	RANK
▶ ALT. ASSETS	- 13.3	88	12.6	51	- 1.2	
MEDIAN	5.0		12.9		0.4	

VERMONT MUNICIPAL EMPLOYEES

PRIVATE EQUITY FUNDS - TOTAL RETURN VS RISK

5 YEARS ENDING 9/05

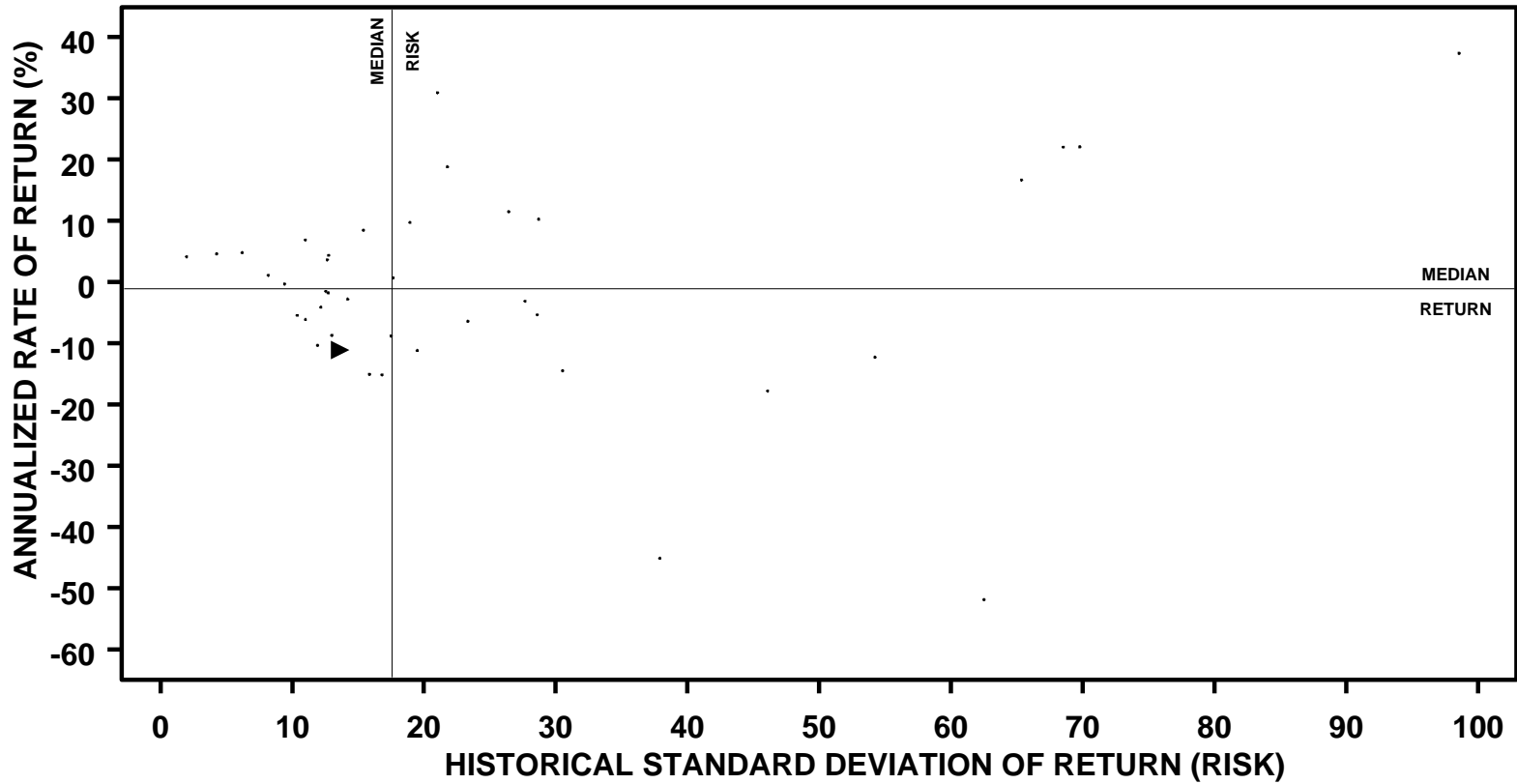

	ANNUALIZED RETURN		STANDARD DEVIATION		SHARPE RATIO	
	VALUE	RANK	VALUE	RANK	VALUE	RANK
▶ ALT. ASSETS	- 11.0	77	13.7	61	- 0.9	
MEDIAN	- 1.1		17.6		- 0.1	

VERMONT MUNICIPAL EMPLOYEES

REAL ESTATE FUNDS - RATES OF RETURN

PERIODS ENDING 9/05

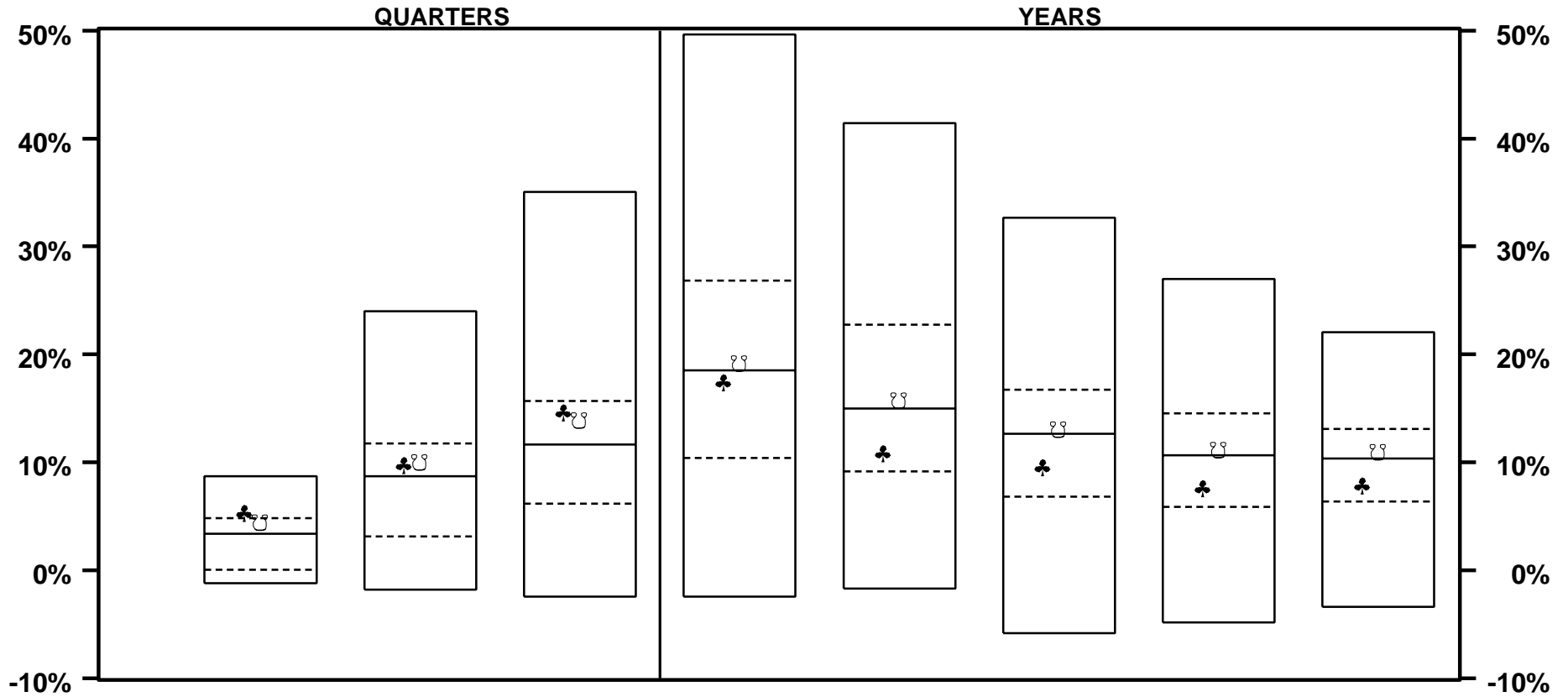

	LAST QTR		LAST 2 QTRS		LAST 3 QTRS		LAST YEAR		LAST 2 YEARS		LAST 3 YEARS		LAST 4 YEARS		LAST 5 YEARS	
♣ SSR TOWER FUND	5.3	17	9.8	41	14.6	31	17.4	52	10.8	70	9.6	67	7.6	67	7.9	66
○ NCREIF PROPERTY	4.4	31	10.0	39	13.9	34	19.2	45	15.7	46	13.0	46	11.2	44	11.0	41
MEDIAN	3.4		8.7		11.6		18.5		15.0		12.6		10.6		10.3	

VERMONT MUNICIPAL EMPLOYEES

REAL ESTATE FUNDS - RATES OF RETURN

PERIODS ENDING 9/05

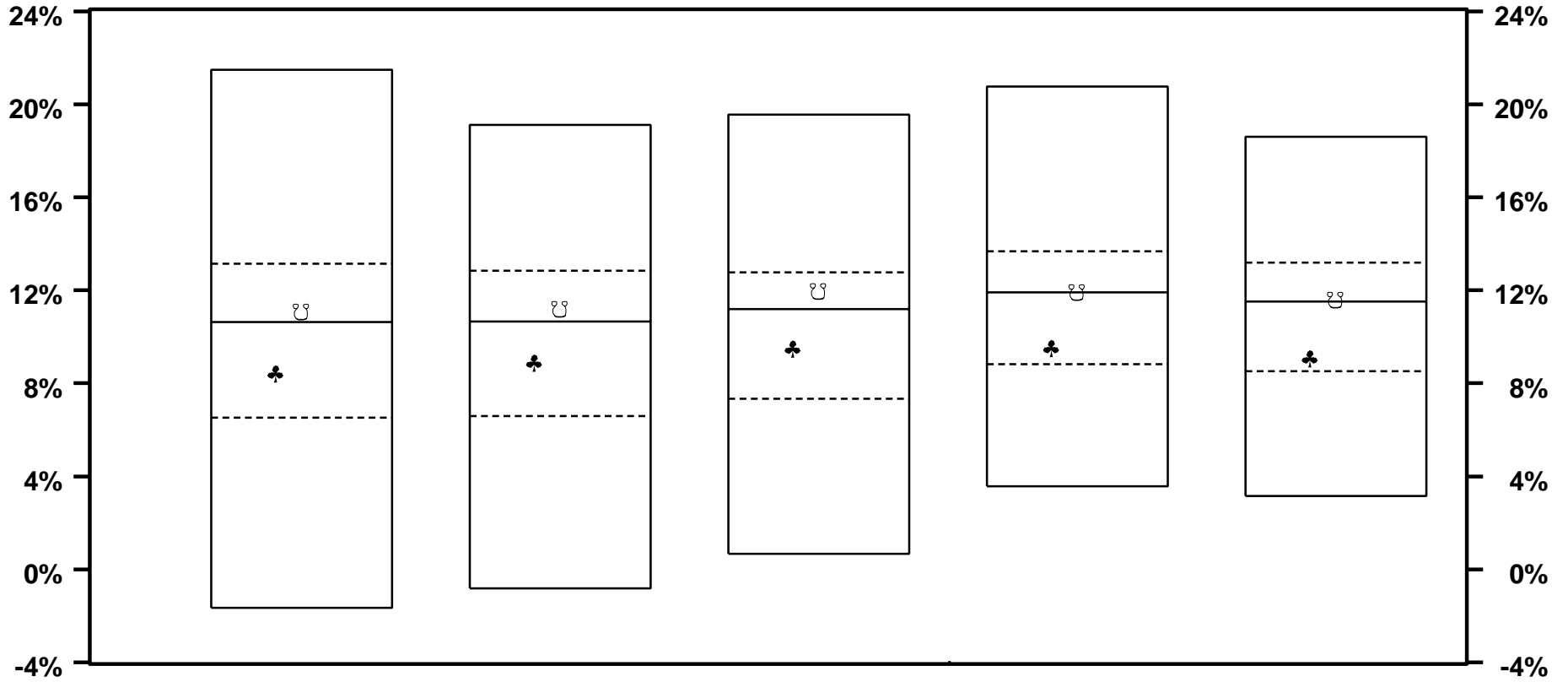

	LAST 6 YEARS		LAST 7 YEARS		LAST 8 YEARS		LAST 9 YEARS		LAST 10 YEARS	
♣ SSR TOWER FUND	8.4	65	8.9	65	9.5	62	9.5	67	9.1	70
∪ NCREIF PROPERTY	11.1	42	11.2	43	12.0	42	11.9	49	11.6	49
MEDIAN	10.6		10.7		11.2		11.9		11.5	

VERMONT MUNICIPAL EMPLOYEES

REAL ESTATE FUNDS - RATES OF RETURN

YEARS ENDING

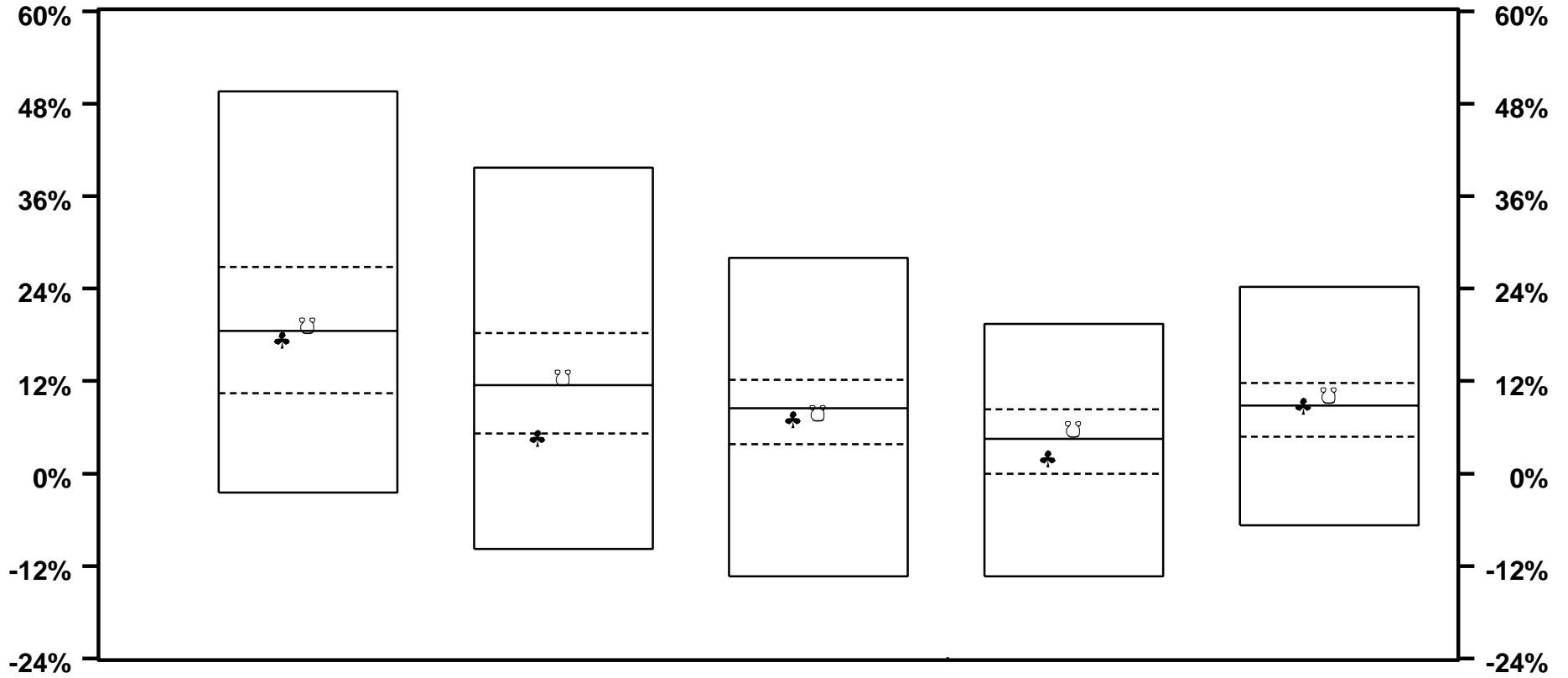

	9 / 05		9 / 04		9 / 03		9 / 02		9 / 01	
♣ SSR TOWER FUND	17.4	52	4.7	76	7.1	60	2.0	60	8.8	49
⊖ NCREIF PROPERTY	19.2	45	12.4	43	7.8	55	5.7	43	10.1	35
MEDIAN	18.5		11.5		8.5		4.5		8.8	

VERMONT MUNICIPAL EMPLOYEES

REAL ESTATE FUNDS - RATES OF RETURN

YEARS ENDING

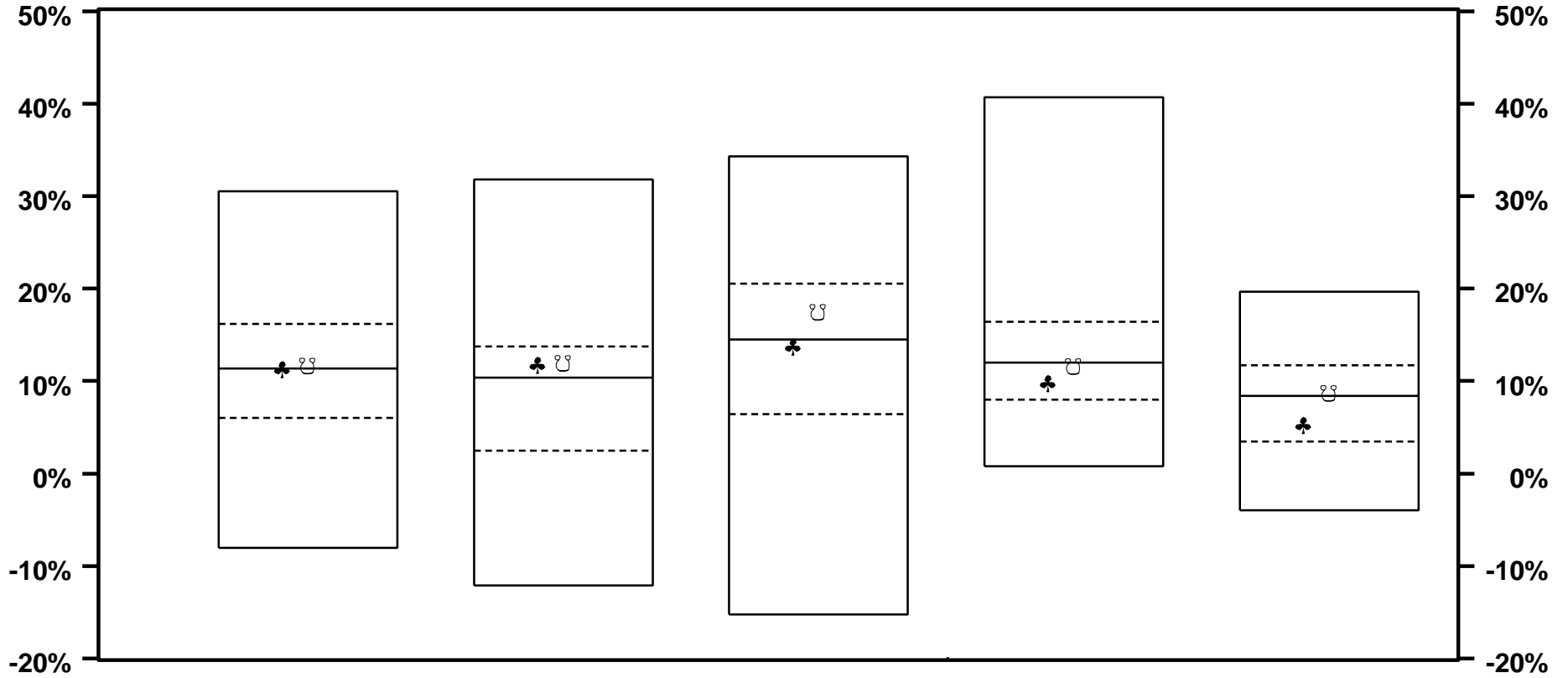

	9 / 00		9 / 99		9 / 98		9 / 97		9 / 96	
♣ SSR TOWER FUND	11.3	50	11.7	42	13.7	52	9.8	65	5.3	67
☵ NCREIF PROPERTY	11.6	47	11.9	41	17.5	35	11.6	52	8.7	46
MEDIAN	11.3		10.4		14.5		12.0		8.4	

VERMONT MUNICIPAL EMPLOYEES

REAL ESTATE ONLY - RATES OF RETURN

PERIODS ENDING 9/05

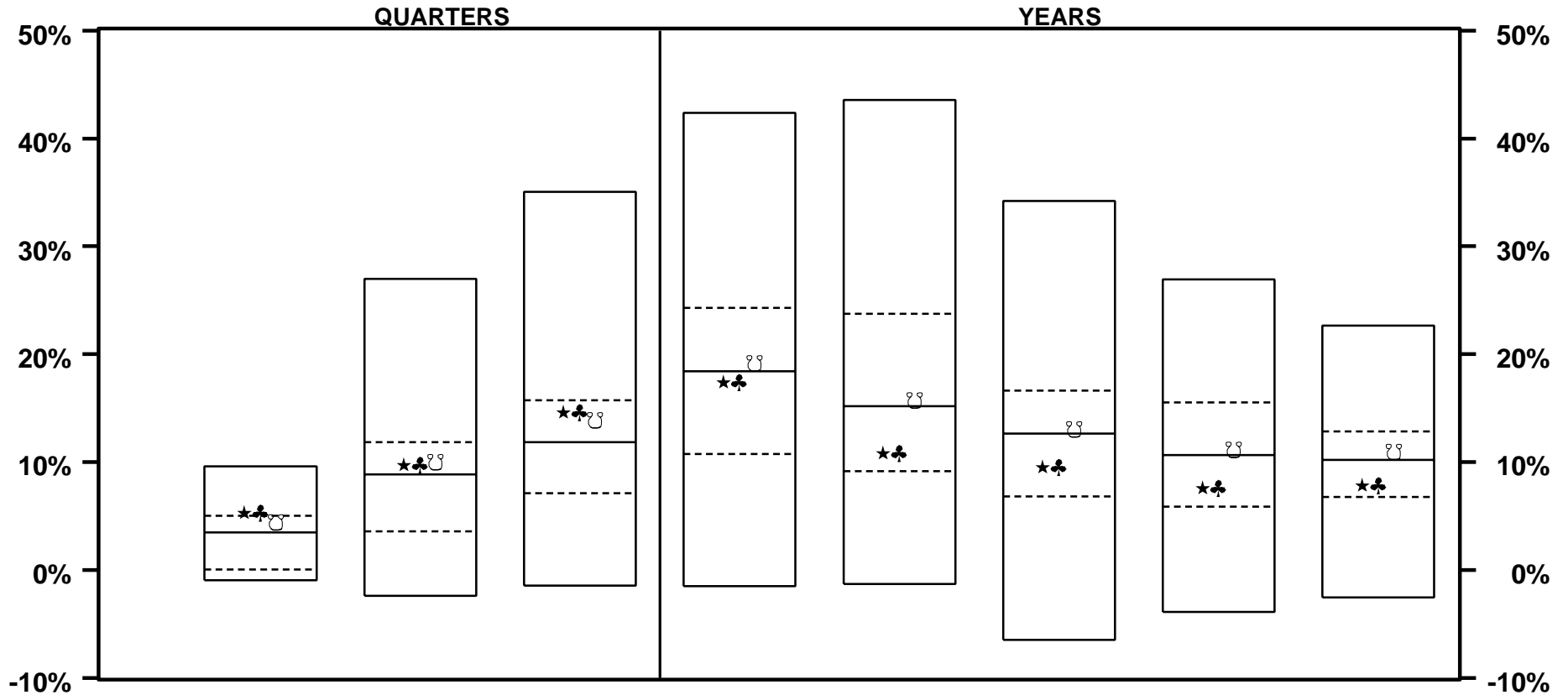

	LAST QTR		LAST 2 QTRS		LAST 3 QTRS		LAST YEAR		LAST 2 YEARS		LAST 3 YEARS		LAST 4 YEARS		LAST 5 YEARS	
★ MUNI COMPOSITE	5.3	19	9.8	42	14.6	32	17.4	52	10.8	71	9.6	69	7.6	68	7.9	67
♣ SSR TOWER FUND	5.3	19	9.8	42	14.6	32	17.4	52	10.8	71	9.6	69	7.6	68	7.9	67
○ NCREIF PROPERTY	4.4	33	10.0	40	13.9	35	19.2	44	15.7	47	13.0	45	11.2	45	11.0	37
MEDIAN	3.5		8.9		11.8		18.4		15.2		12.6		10.6		10.2	

VERMONT MUNICIPAL EMPLOYEES

REAL ESTATE ONLY - RATES OF RETURN

PERIODS ENDING 9/05

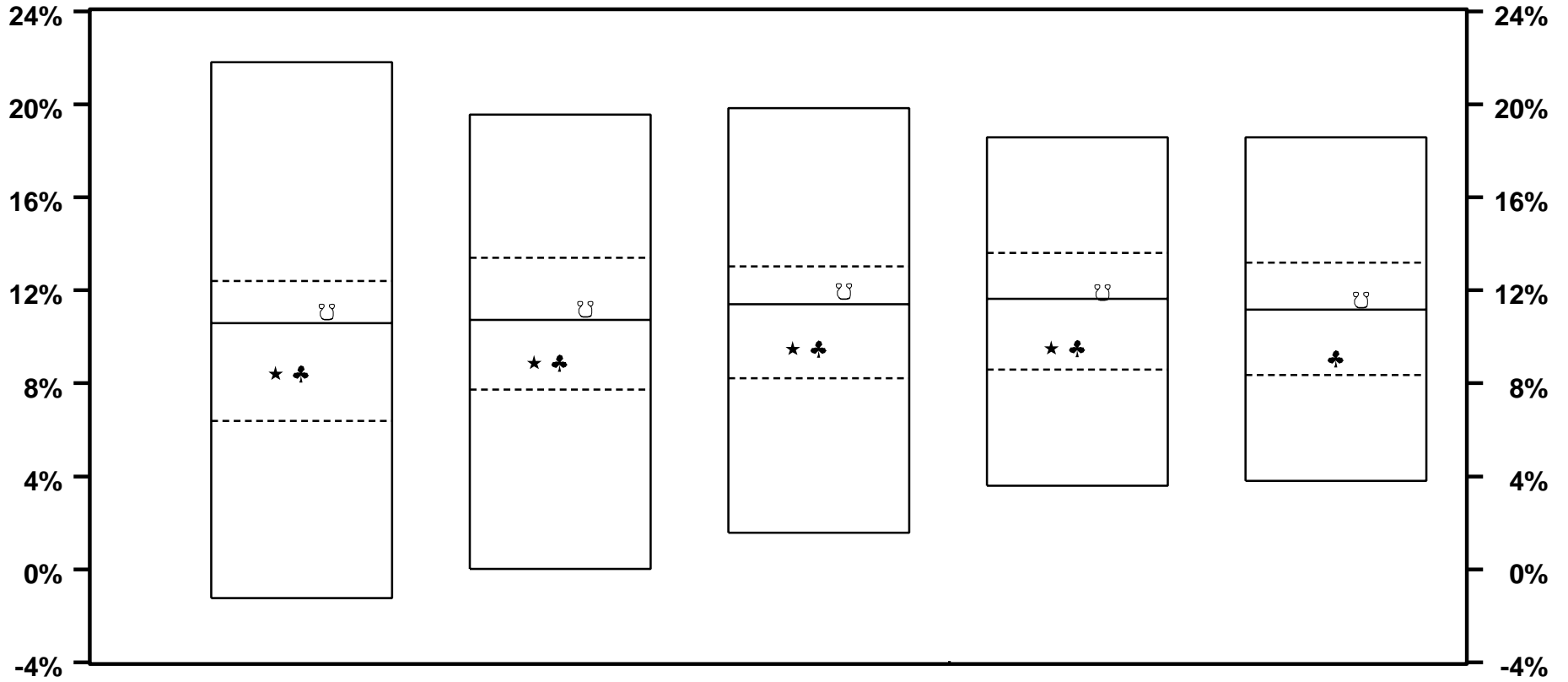

	LAST 6 YEARS		LAST 7 YEARS		LAST 8 YEARS		LAST 9 YEARS		LAST 10 YEARS	
★ MUNI COMPOSITE	8.4	63	8.9	66	9.5	65	9.5	67		
♣ SSR TOWER FUND	8.4	63	8.9	66	9.5	65	9.5	67	9.1	70
∪ NCREIF PROPERTY	11.1	40	11.2	42	12.0	45	11.9	47	11.6	45
MEDIAN	10.6		10.7		11.4		11.6		11.2	

VERMONT MUNICIPAL EMPLOYEES

REAL ESTATE ONLY - RATES OF RETURN

YEARS ENDING

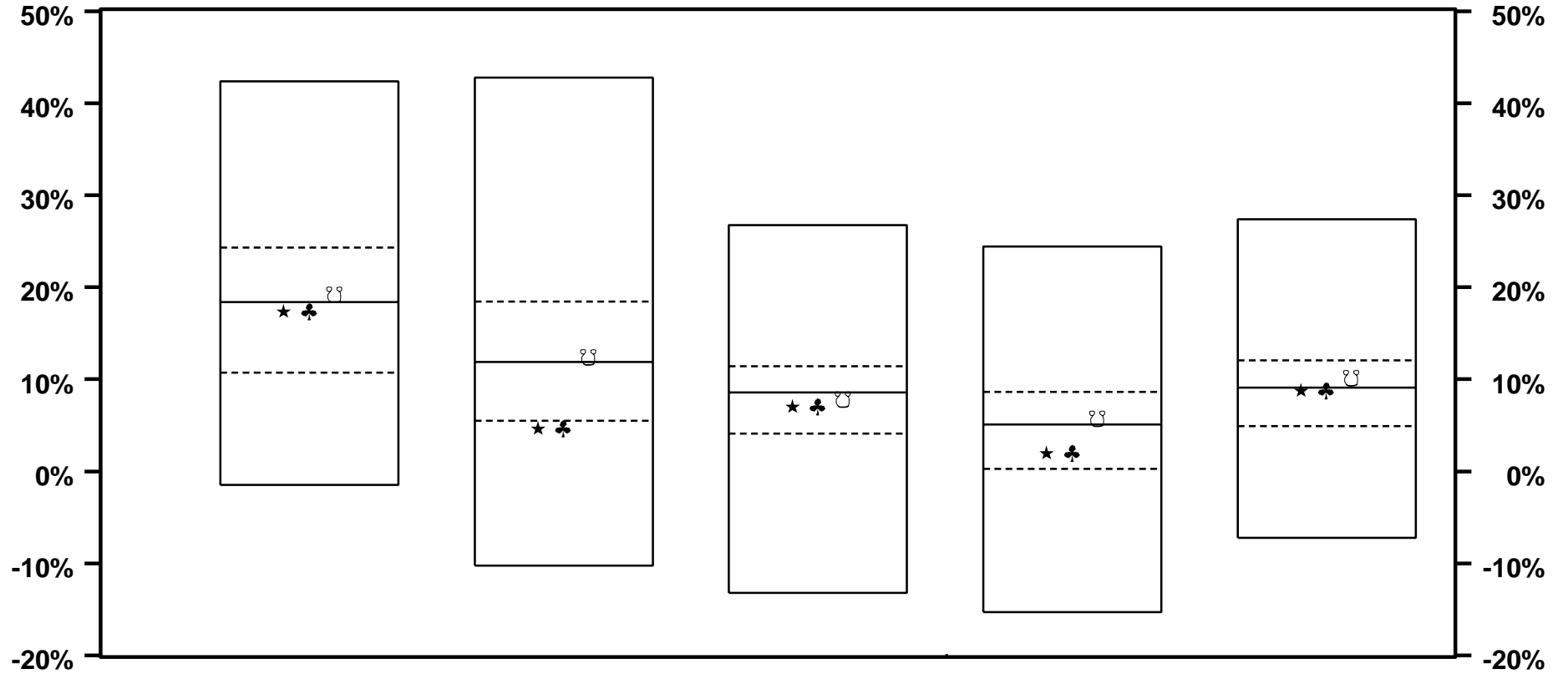

	9 / 05		9 / 04		9 / 03		9 / 02		9 / 01	
★ MUNI COMPOSITE	17.4	52	4.7	77	7.1	62	2.0	62	8.8	51
♣ SSR TOWER FUND	17.4	52	4.7	77	7.1	62	2.0	62	8.8	51
○ NCREIF PROPERTY	19.2	44	12.4	44	7.8	56	5.7	45	10.1	37
MEDIAN	18.4		11.8		8.6		5.1		9.1	

VERMONT MUNICIPAL EMPLOYEES

REAL ESTATE ONLY - RATES OF RETURN

YEARS ENDING

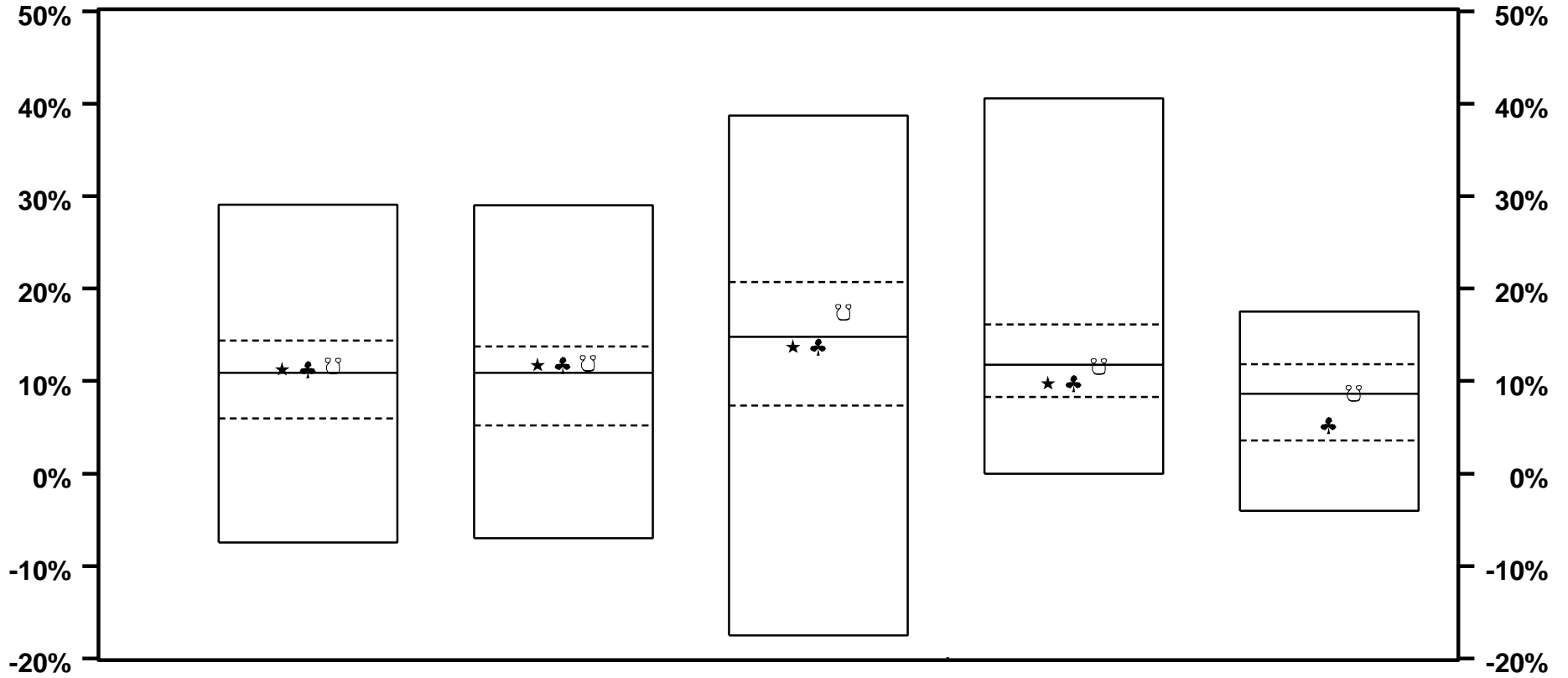

	9 / 00		9 / 99		9 / 98		9 / 97		9 / 96	
★ MUNI COMPOSITE	11.3	48	11.7	45	13.7	53	9.8	65		
♣ SSR TOWER FUND	11.3	48	11.7	45	13.7	53	9.8	65	5.3	68
○ NCREIF PROPERTY	11.6	44	11.9	44	17.5	36	11.6	51	8.7	49
MEDIAN	10.9		10.9		14.8		11.8		8.6	

VERMONT MUNICIPAL EMPLOYEES

REIT - EQUITY ONLY RATES OF RETURN

PERIODS ENDING 9/05

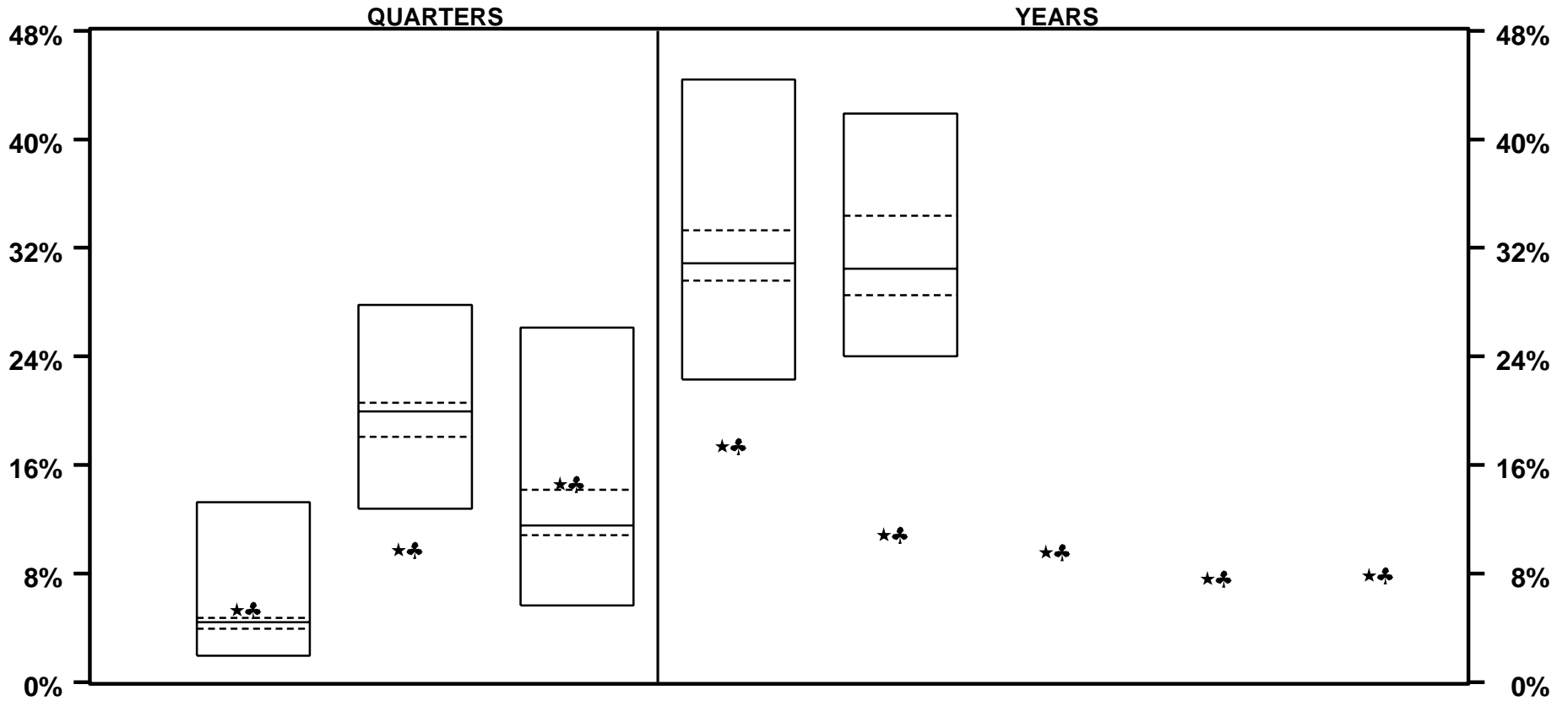

	LAST QTR		LAST 2 QTRS		LAST 3 QTRS		LAST YEAR		LAST 2 YEARS		LAST 3 YEARS		LAST 4 YEARS		LAST 5 YEARS	
★ MUNI COMPOSITE	5.3	23	9.8	95	14.6	24	17.4	95	10.8	95	9.6	7.6	7.9			
♣ SSR TOWER FUND	5.3	23	9.8	95	14.6	24	17.4	95	10.8	95	9.6	7.6	7.9			
MEDIAN	4.4		19.9		11.6		30.9		30.5							

VERMONT MUNICIPAL EMPLOYEES

REIT - EQUITY ONLY RATES OF RETURN

PERIODS ENDING 9/05

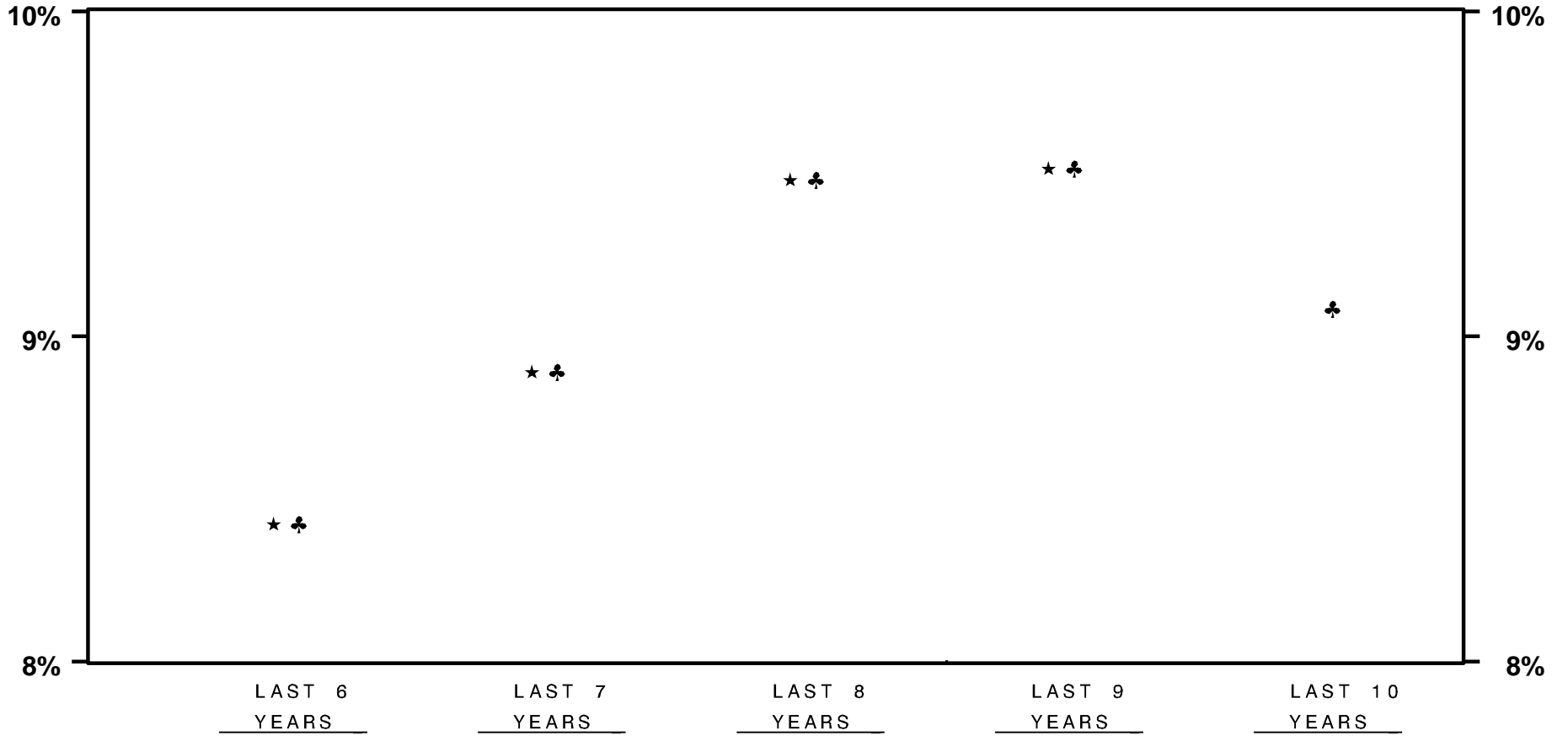

★ MUNI COMPOSITE
♣ SSR TOWER FUND

MEDIAN

VERMONT MUNICIPAL EMPLOYEES

REIT - EQUITY ONLY RATES OF RETURN

YEARS ENDING

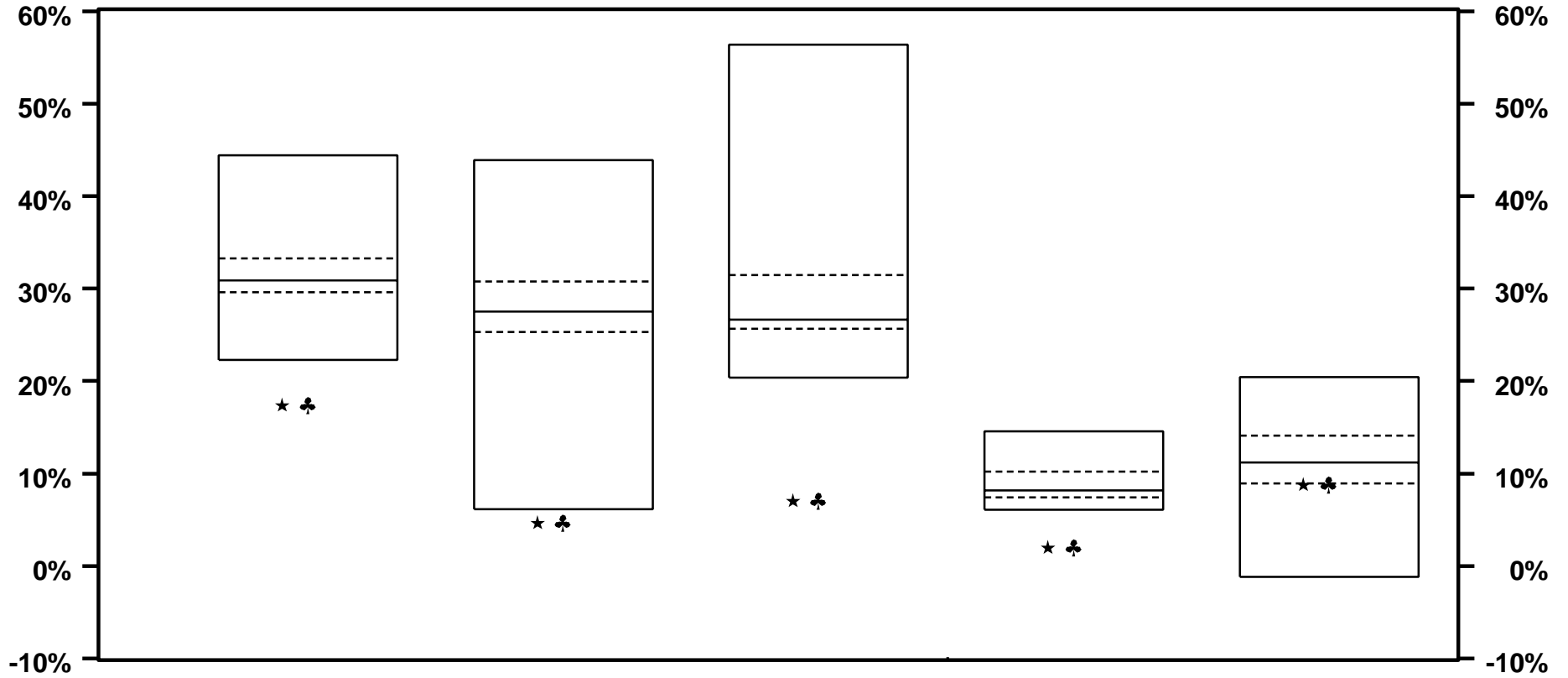

	9 / 05		9 / 04		9 / 03		9 / 02		9 / 01	
★ MUNI COMPOSITE	17.4	95	4.7	96	7.1	95	2.0	95	8.8	76
♣ SSR TOWER FUND	17.4	95	4.7	96	7.1	95	2.0	95	8.8	76
MEDIAN	30.9		27.5		26.7		8.2		11.2	

VERMONT MUNICIPAL EMPLOYEES

REIT - EQUITY ONLY RATES OF RETURN

YEARS ENDING

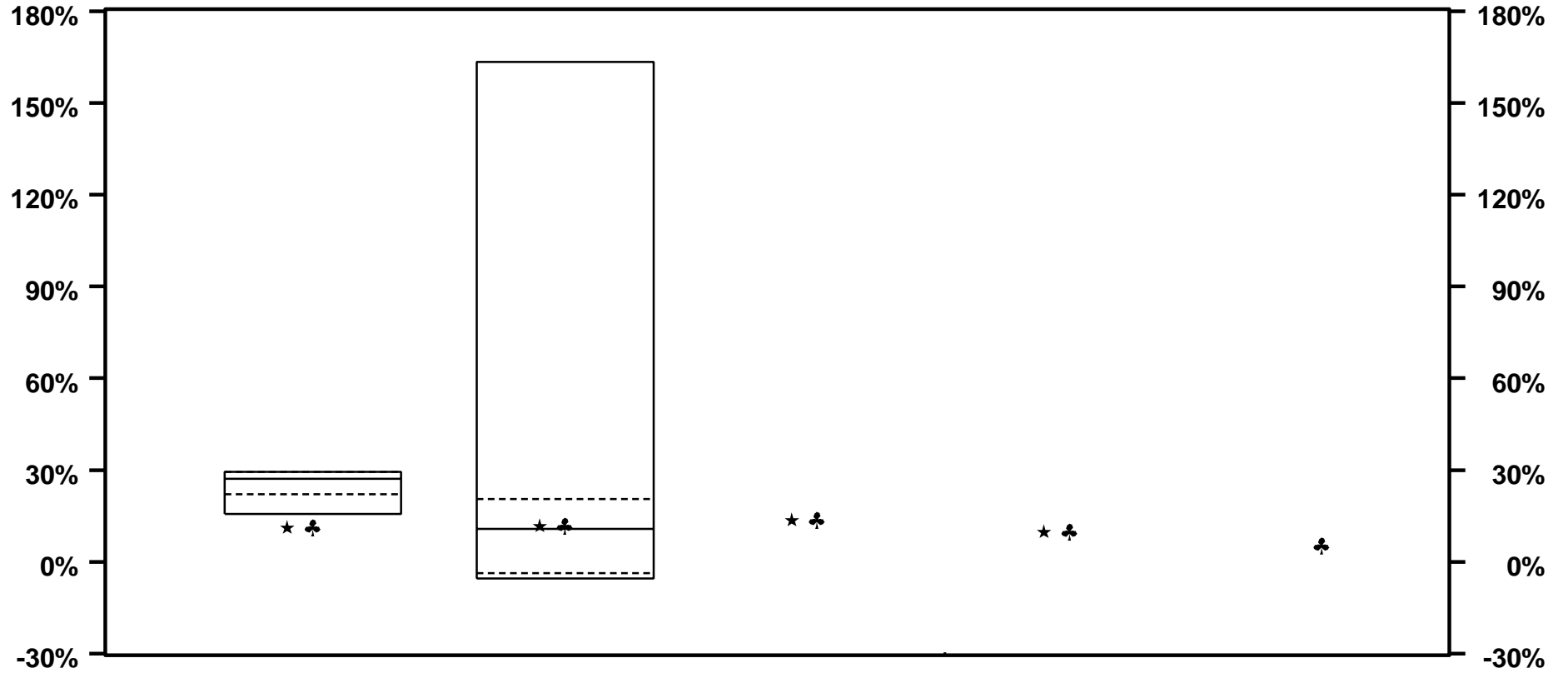

	9 / 00		9 / 99		9 / 98	9 / 97	9 / 96
★ MUNI COMPOSITE	11.3	95	11.7	48	13.7	9.8	
♣ SSR TOWER FUND	11.3	95	11.7	48	13.7	9.8	5.3
MEDIAN	27.1		10.8				

VERMONT MUNICIPAL EMPLOYEES
EQUITY ONLY SUMMARY STATISTICS
QUARTER ENDING 9/05
MUNICIPAL SYSTEM COMPOSITE

	PORTFOLIO	S&P 500
TOTAL NUMBER OF SECURITIES	251	
TOTAL MARKET VALUE \$	101,369,772	
AVERAGE MARKET CAPITALIZATION (000's)	56,898,000	88,707,500
MEDIAN MARKET CAPITALIZATION (000's)		11,487,200
EQUITY SEGMENT YIELD	1.17	1.83
EQUITY SEGMENT P/E	19.02	17.02
EQUITY SEGMENT BETA	1.18	1.00
PRICE/BOOK RATIO	4.15	3.72
FIVE YEAR EARNINGS GROWTH	14.96	11.75
RETURN ON EQUITY	18.81	19.44

TEN LARGEST HOLDINGS

TEN BEST PERFORMERS

TEN WORST PERFORMERS

<u>NAME</u>	<u>\$</u>	<u>WEIGHT</u>	<u>NAME</u>	<u>RETURN</u>	<u>NAME</u>	<u>RETURN</u>
GENERAL ELEC CO	2,398,236	2.4	TODCO	67.6	KINDRED HEALTHCARE	- 24.8
PROCTER & GAMBLE CO	1,905,098	1.9	HANGER ORTHOPEDIC C	52.8	CARMIKE CINEMAS INC	- 24.7
GOOGLE INC	1,840,214	1.8	CLEVELAND CLIFFS IN	51.2	SWIFT TRANSN INC	- 24.0
QUALCOMM INC	1,687,478	1.7	APPLE COMPUTER INC	45.6	FINISH LINE INC	- 22.7
YAHOO INC	1,629,904	1.6	OIL STS INTL INC	44.3	ALLIANCE GAMING COR	- 22.6
APPLE COMPUTER INC	1,533,353	1.5	RANGE RES CORP	43.6	DICKS SPORTING GOOD	- 22.0
CITIGROUP INC	1,483,952	1.5	HALLIBURTON CO	43.6	FOSSIL INC	- 19.9
PFIZER INC	1,398,320	1.4	BRIGHAM EXPL CO	40.7	COHERENT INC COM	- 18.7
BANK OF AMERICA COR	1,382,480	1.4	AIRTRAN HLDGS INC	37.2	WABASH NATL CORP	- 18.7
MORGAN STANLEY DEAN	1,294,560	1.3	QUALCOMM INC	35.9	NETWORK APPLIANCE I	- 16.0

VERMONT MUNICIPAL EMPLOYEES
EQUITY ONLY SUMMARY STATISTICS
QUARTER ENDING 9/05
DOMESTIC EQUITY COMPOSITE

	<u>PORTFOLIO</u>	<u>S&P 500</u>
TOTAL NUMBER OF SECURITIES	251	
TOTAL MARKET VALUE \$	101,369,772	
AVERAGE MARKET CAPITALIZATION (000's)	56,898,000	88,707,500
MEDIAN MARKET CAPITALIZATION (000's)		11,487,200
EQUITY SEGMENT YIELD	1.17	1.83
EQUITY SEGMENT P/E	19.02	17.02
EQUITY SEGMENT BETA	1.18	1.00
PRICE/BOOK RATIO	4.15	3.72
FIVE YEAR EARNINGS GROWTH	14.96	11.75
RETURN ON EQUITY	18.81	19.44

TEN LARGEST HOLDINGS

TEN BEST PERFORMERS

TEN WORST PERFORMERS

<u>NAME</u>	<u>\$</u>	<u>WEIGHT</u>	<u>NAME</u>	<u>RETURN</u>	<u>NAME</u>	<u>RETURN</u>
GENERAL ELEC CO	2,398,236	2.4	TODCO	67.6	KINDRED HEALTHCARE	-24.8
PROCTER & GAMBLE CO	1,905,098	1.9	HANGER ORTHOPEDIC C	52.8	CARMIKE CINEMAS INC	-24.7
GOOGLE INC	1,840,214	1.8	CLEVELAND CLIFFS IN	51.2	SWIFT TRANSN INC	-24.0
QUALCOMM INC	1,687,478	1.7	APPLE COMPUTER INC	45.6	FINISH LINE INC	-22.7
YAHOO INC	1,629,904	1.6	OIL STS INTL INC	44.3	ALLIANCE GAMING COR	-22.6
APPLE COMPUTER INC	1,533,353	1.5	RANGE RES CORP	43.6	DICKS SPORTING GOOD	-22.0
CITIGROUP INC	1,483,952	1.5	HALLIBURTON CO	43.6	FOSSIL INC	-19.9
PFIZER INC	1,398,320	1.4	BRIGHAM EXPL CO	40.7	COHERENT INC COM	-18.7
BANK OF AMERICA COR	1,382,480	1.4	AIRTRAN HLDGS INC	37.2	WABASH NATL CORP	-18.7
MORGAN STANLEY DEAN	1,294,560	1.3	QUALCOMM INC	35.9	NETWORK APPLIANCE I	-16.0

VERMONT MUNICIPAL EMPLOYEES
EQUITY ONLY SUMMARY STATISTICS
QUARTER ENDING 9/05

DELAWARE

	<u>PORTFOLIO</u>	<u>R 1000(R) VALUE</u>
TOTAL NUMBER OF SECURITIES	56	
TOTAL MARKET VALUE	\$ 35,678,727	
AVERAGE MARKET CAPITALIZATION (000's)	99,238,400	83,472,300
MEDIAN MARKET CAPITALIZATION (000's)	39,977,500	4,707,300
EQUITY SEGMENT YIELD	2.21	2.44
EQUITY SEGMENT P/E	15.51	14.39
EQUITY SEGMENT BETA	0.91	0.92
PRICE/BOOK RATIO	3.66	2.46
FIVE YEAR EARNINGS GROWTH	8.43	9.71
RETURN ON EQUITY	19.65	16.27

TEN LARGEST HOLDINGS

TEN BEST PERFORMERS

TEN WORST PERFORMERS

<u>NAME</u>	<u>\$</u>	<u>WEIGHT</u>	<u>NAME</u>	<u>RETURN</u>	<u>NAME</u>	<u>RETURN</u>
CITIGROUP INC	1,483,952	4.2	MARATHON OIL CORP	29.8	PFIZER INC	- 8.8
PFIZER INC	1,398,320	3.9	CATERPILLAR INC	23.9	WAL MART STORES INC	- 8.8
BANK OF AMERICA COR	1,382,480	3.9	MCDONALD'S CORP	20.7	DU PONT E I DE NEMO	- 8.1
MORGAN STANLEY DEAN	1,294,560	3.6	NATIONAL SEMICONDUCT	19.0	AIR PRODS & CHEMS I	- 8.0
GENERAL ELEC CO	1,201,268	3.4	DOMINION RES INC VA	18.4	BANK OF AMERICA COR	- 6.6
MERRILL LYNCH & CO	1,159,515	3.2	BCE INC	17.0	CISCO SYS INC	- 6.1
WYETH	939,281	2.6	CHEVRON CORP	16.6	ORACLE CORP	- 6.1
PEPSICO INC COM	930,044	2.6	GILLETTE CO COM	15.3	DOW CHEM CO	- 5.7
EXXON MOBIL CORP	894,897	2.5	BP AMOCO P L C	14.4	NIKE INC	- 5.4
ALLTEL CORP	865,494	2.4	FPL GROUP INC	14.1	ANHEUSER BUSCH COS	- 5.4

VERMONT MUNICIPAL EMPLOYEES
EQUITY ONLY SUMMARY STATISTICS
QUARTER ENDING 9/05

ALLIANCE LARGE CAP GROWTH FUND

	PORTFOLIO	R 1000(R) GR
TOTAL NUMBER OF SECURITIES	53	
TOTAL MARKET VALUE	\$ 38,588,398	
AVERAGE MARKET CAPITALIZATION (000's)	56,882,100	74,925,100
MEDIAN MARKET CAPITALIZATION (000's)	22,196,100	5,165,200
EQUITY SEGMENT YIELD	0.48	1.08
EQUITY SEGMENT P/E	27.75	21.77
EQUITY SEGMENT BETA	1.32	1.14
PRICE/BOOK RATIO	5.75	5.06
FIVE YEAR EARNINGS GROWTH	25.54	14.66
RETURN ON EQUITY	21.36	21.89

TEN LARGEST HOLDINGS

TEN BEST PERFORMERS

TEN WORST PERFORMERS

<u>NAME</u>	<u>\$</u>	<u>WEIGHT</u>	<u>NAME</u>	<u>RETURN</u>	<u>NAME</u>	<u>RETURN</u>
GOOGLE INC	1,840,214	4.8	APPLE COMPUTER INC	45.6	NETWORK APPLIANCE I	-16.0
QUALCOMM INC	1,687,478	4.4	HALLIBURTON CO	43.6	DELL INC	-13.3
YAHOO INC	1,629,904	4.2	QUALCOMM INC	35.9	ZIMMER HLDGS INC	-9.6
APPLE COMPUTER INC	1,533,353	4.0	BROADCOM CORP	32.1	CARNIVAL CORP COM	-8.0
DELL INC	1,273,505	3.3	AMGEN INC	31.8	E M C CORP MASS	-5.6
GENENTECH INC	1,238,392	3.2	EBAY INC	24.8	JUNIPER NETWORKS IN	-5.5
HALLIBURTON CO	1,220,273	3.2	MARVELL TECHNOLOGY	21.4	TARGET CORP	-4.4
PROCTER & GAMBLE CO	1,215,362	3.1	GOLDMAN SACHS GROUP	19.4	LILLY ELI & CO	-3.3
ALCON INC	1,207,698	3.1	NABORS INDUSTRIES L	18.5	STARBUCKS CORP	-3.0
LOWES COS INC	1,198,999	3.1	ALCON INC	16.9	YAHOO INC	-2.3

VERMONT MUNICIPAL EMPLOYEES
EQUITY ONLY SUMMARY STATISTICS
QUARTER ENDING 9/05

LAZARD SMALL CAP FUND

	PORTFOLIO	R 2000(R)
TOTAL NUMBER OF SECURITIES	145	
TOTAL MARKET VALUE \$	27,102,647	
AVERAGE MARKET CAPITALIZATION (000's)	1,182,500	1,065,300
MEDIAN MARKET CAPITALIZATION (000's)	1,073,700	571,200
EQUITY SEGMENT YIELD	0.78	1.07
EQUITY SEGMENT P/E	16.27	17.19
EQUITY SEGMENT BETA	1.31	1.28
PRICE/BOOK RATIO	2.68	3.10
FIVE YEAR EARNINGS GROWTH	8.67	9.28
RETURN ON EQUITY	13.98	11.29

TEN LARGEST HOLDINGS

TEN BEST PERFORMERS

TEN WORST PERFORMERS

<u>NAME</u>	<u>\$</u>	<u>WEIGHT</u>	<u>NAME</u>	<u>RETURN</u>	<u>NAME</u>	<u>RETURN</u>
RTI INTL METALS INC	388,887	1.4	TODCO	67.6	KINDRED HEALTHCARE	-24.8
OMI CORP NEW	354,980	1.3	HANGER ORTHOPEDIC C	52.8	CARMIKE CINEMAS INC	-24.7
OREGON STL MLS INC	330,737	1.2	CLEVELAND CLIFFS IN	51.2	SWIFT TRANSN INC	-24.0
INTEGRATED DEVICE T	329,498	1.2	OIL STS INTL INC	44.3	FINISH LINE INC	-22.7
SAFENET INC	328,291	1.2	RANGE RES CORP	43.6	ALLIANCE GAMING COR	-22.6
ADVO INC	314,137	1.2	BRIGHAM EXPL CO	40.7	DICKS SPORTING GOOD	-22.0
LIFEPOINT HOSPS INC	309,881	1.1	AIRTRAN HLDGS INC	37.2	FOSSIL INC	-19.9
STEEL DYNAMICS INC	296,398	1.1	VERITAS DOC INC	32.0	COHERENT INC COM	-18.7
LIBERTY CORP COM	292,045	1.1	DOT HILL SYS CORP	28.4	WABASH NATL CORP	-18.7
DRESSER-RAND GROUP	291,364	1.1	LIBERTY CORP COM	28.1	BANKUNITED FINL COR	-15.4

VERMONT MUNICIPAL EMPLOYEES
DOMESTIC EQUITY ONLY SUMMARY STATISTICS
QUARTER ENDING 9/05

MUNICIPAL SYSTEM COMPOSITE

	PORTFOLIO	S&P 500
TOTAL NUMBER OF SECURITIES	251	
TOTAL MARKET VALUE \$	101,369,772	
AVERAGE MARKET CAPITALIZATION (000's)	57,865,700	89,462,700
MEDIAN MARKET CAPITALIZATION (000's)		11,492,700
EQUITY SEGMENT YIELD	1.18	1.84
EQUITY SEGMENT P/E	19.02	16.96
EQUITY SEGMENT BETA	1.17	1.00
PRICE/BOOK RATIO	4.17	3.71
FIVE YEAR EARNINGS GROWTH	14.96	11.86
RETURN ON EQUITY	18.86	19.47

TEN LARGEST HOLDINGS

TEN BEST PERFORMERS

TEN WORST PERFORMERS

<u>NAME</u>	<u>\$</u>	<u>WEIGHT</u>	<u>NAME</u>	<u>RETURN</u>	<u>NAME</u>	<u>RETURN</u>
GENERAL ELEC CO	2,398,236	2.4	TODCO	67.6	KINDRED HEALTHCARE	-24.8
PROCTER & GAMBLE CO	1,905,098	1.9	HANGER ORTHOPEDIC C	52.8	CARMIKE CINEMAS INC	-24.7
GOOGLE INC	1,840,214	1.8	CLEVELAND CLIFFS IN	51.2	SWIFT TRANSN INC	-24.0
QUALCOMM INC	1,687,478	1.7	APPLE COMPUTER INC	45.6	FINISH LINE INC	-22.7
YAHOO INC	1,629,904	1.6	OIL STS INTL INC	44.3	ALLIANCE GAMING COR	-22.6
APPLE COMPUTER INC	1,533,353	1.5	RANGE RES CORP	43.6	DICKS SPORTING GOOD	-22.0
CITIGROUP INC	1,483,952	1.5	HALLIBURTON CO	43.6	FOSSIL INC	-19.9
PFIZER INC	1,398,320	1.4	BRIGHAM EXPL CO	40.7	COHERENT INC COM	-18.7
BANK OF AMERICA COR	1,382,480	1.4	AIRTRAN HLDGS INC	37.2	WABASH NATL CORP	-18.7
MORGAN STANLEY DEAN	1,294,560	1.3	QUALCOMM INC	35.9	NETWORK APPLIANCE I	-16.0

VERMONT MUNICIPAL EMPLOYEES
DOMESTIC EQUITY ONLY SUMMARY STATISTICS
QUARTER ENDING 9/05

DOMESTIC EQUITY COMPOSITE

	PORTFOLIO	S&P 500
TOTAL NUMBER OF SECURITIES	251	
TOTAL MARKET VALUE \$	101,369,772	
AVERAGE MARKET CAPITALIZATION (000's)	57,865,700	89,462,700
MEDIAN MARKET CAPITALIZATION (000's)		11,492,700
EQUITY SEGMENT YIELD	1.18	1.84
EQUITY SEGMENT P/E	19.02	16.96
EQUITY SEGMENT BETA	1.17	1.00
PRICE/BOOK RATIO	4.17	3.71
FIVE YEAR EARNINGS GROWTH	14.96	11.86
RETURN ON EQUITY	18.86	19.47

TEN LARGEST HOLDINGS

TEN BEST PERFORMERS

TEN WORST PERFORMERS

<u>NAME</u>	<u>\$</u>	<u>WEIGHT</u>	<u>NAME</u>	<u>RETURN</u>	<u>NAME</u>	<u>RETURN</u>
GENERAL ELEC CO	2,398,236	2.4	TODCO	67.6	KINDRED HEALTHCARE	-24.8
PROCTER & GAMBLE CO	1,905,098	1.9	HANGER ORTHOPEDIC C	52.8	CARMIKE CINEMAS INC	-24.7
GOOGLE INC	1,840,214	1.8	CLEVELAND CLIFFS IN	51.2	SWIFT TRANSN INC	-24.0
QUALCOMM INC	1,687,478	1.7	APPLE COMPUTER INC	45.6	FINISH LINE INC	-22.7
YAHOO INC	1,629,904	1.6	OIL STS INTL INC	44.3	ALLIANCE GAMING COR	-22.6
APPLE COMPUTER INC	1,533,353	1.5	RANGE RES CORP	43.6	DICKS SPORTING GOOD	-22.0
CITIGROUP INC	1,483,952	1.5	HALLIBURTON CO	43.6	FOSSIL INC	-19.9
PFIZER INC	1,398,320	1.4	BRIGHAM EXPL CO	40.7	COHERENT INC COM	-18.7
BANK OF AMERICA COR	1,382,480	1.4	AIRTRAN HLDGS INC	37.2	WABASH NATL CORP	-18.7
MORGAN STANLEY DEAN	1,294,560	1.3	QUALCOMM INC	35.9	NETWORK APPLIANCE I	-16.0

VERMONT MUNICIPAL EMPLOYEES
DOMESTIC EQUITY ONLY SUMMARY STATISTICS
QUARTER ENDING 9/05

DELAWARE

	<u>PORTFOLIO</u>	<u>R 1000(R) VALUE</u>
TOTAL NUMBER OF SECURITIES	56	
TOTAL MARKET VALUE	\$ 35,678,727	
AVERAGE MARKET CAPITALIZATION (000's)	99,238,400	83,574,300
MEDIAN MARKET CAPITALIZATION (000's)	39,977,500	4,707,300
EQUITY SEGMENT YIELD	2.21	2.44
EQUITY SEGMENT P/E	15.51	14.39
EQUITY SEGMENT BETA	0.91	0.92
PRICE/BOOK RATIO	3.66	2.46
FIVE YEAR EARNINGS GROWTH	8.43	9.71
RETURN ON EQUITY	19.65	16.28

TEN LARGEST HOLDINGS

TEN BEST PERFORMERS

TEN WORST PERFORMERS

<u>NAME</u>	<u>\$</u>	<u>WEIGHT</u>	<u>NAME</u>	<u>RETURN</u>	<u>NAME</u>	<u>RETURN</u>
CITIGROUP INC	1,483,952	4.2	MARATHON OIL CORP	29.8	PFIZER INC	- 8.8
PFIZER INC	1,398,320	3.9	CATERPILLAR INC	23.9	WAL MART STORES INC	- 8.8
BANK OF AMERICA COR	1,382,480	3.9	MCDONALD'S CORP	20.7	DU PONT E I DE NEMO	- 8.1
MORGAN STANLEY DEAN	1,294,560	3.6	NATIONAL SEMICONDUCT	19.0	AIR PRODS & CHEMS I	- 8.0
GENERAL ELEC CO	1,201,268	3.4	DOMINION RES INC VA	18.4	BANK OF AMERICA COR	- 6.6
MERRILL LYNCH & CO	1,159,515	3.2	BCE INC	17.0	CISCO SYS INC	- 6.1
WYETH	939,281	2.6	CHEVRON CORP	16.6	ORACLE CORP	- 6.1
PEPSICO INC COM	930,044	2.6	GILLETTE CO COM	15.3	DOW CHEM CO	- 5.7
EXXON MOBIL CORP	894,897	2.5	BP AMOCO P L C	14.4	NIKE INC	- 5.4
ALLTEL CORP	865,494	2.4	FPL GROUP INC	14.1	ANHEUSER BUSCH COS	- 5.4

VERMONT MUNICIPAL EMPLOYEES
DOMESTIC EQUITY ONLY SUMMARY STATISTICS
QUARTER ENDING 9/05

ALLIANCE LARGE CAP GROWTH FUND

	PORTFOLIO	R 1000(R) GR
TOTAL NUMBER OF SECURITIES	53	
TOTAL MARKET VALUE	\$ 38,588,398	
AVERAGE MARKET CAPITALIZATION (000's)	57,939,300	74,973,600
MEDIAN MARKET CAPITALIZATION (000's)	22,196,100	5,165,200
EQUITY SEGMENT YIELD	0.48	1.08
EQUITY SEGMENT P/E	27.75	21.78
EQUITY SEGMENT BETA	1.31	1.14
PRICE/BOOK RATIO	5.80	5.06
FIVE YEAR EARNINGS GROWTH	25.77	14.64
RETURN ON EQUITY	21.68	21.89

TEN LARGEST HOLDINGS

TEN BEST PERFORMERS

TEN WORST PERFORMERS

<u>NAME</u>	<u>\$</u>	<u>WEIGHT</u>	<u>NAME</u>	<u>RETURN</u>	<u>NAME</u>	<u>RETURN</u>
GOOGLE INC	1,840,214	4.8	APPLE COMPUTER INC	45.6	NETWORK APPLIANCE I	-16.0
QUALCOMM INC	1,687,478	4.4	HALLIBURTON CO	43.6	DELL INC	-13.3
YAHOO INC	1,629,904	4.2	QUALCOMM INC	35.9	ZIMMER HLDGS INC	-9.6
APPLE COMPUTER INC	1,533,353	4.0	BROADCOM CORP	32.1	CARNIVAL CORP COM	-8.0
DELL INC	1,273,505	3.3	AMGEN INC	31.8	E M C CORP MASS	-5.6
GENENTECH INC	1,238,392	3.2	EBAY INC	24.8	JUNIPER NETWORKS IN	-5.5
HALLIBURTON CO	1,220,273	3.2	MARVELL TECHNOLOGY	21.4	TARGET CORP	-4.4
PROCTER & GAMBLE CO	1,215,362	3.1	GOLDMAN SACHS GROUP	19.4	LILLY ELI & CO	-3.3
ALCON INC	1,207,698	3.1	NABORS INDUSTRIES L	18.5	STARBUCKS CORP	-3.0
LOWES COS INC	1,198,999	3.1	ALCON INC	16.9	YAHOO INC	-2.3

VERMONT MUNICIPAL EMPLOYEES
DOMESTIC EQUITY ONLY SUMMARY STATISTICS
QUARTER ENDING 9/05

LAZARD SMALL CAP FUND

	PORTFOLIO	R 2000(R)
TOTAL NUMBER OF SECURITIES	145	
TOTAL MARKET VALUE	\$ 27,102,647	
AVERAGE MARKET CAPITALIZATION (000's)	1,156,600	1,064,900
MEDIAN MARKET CAPITALIZATION (000's)	985,600	571,100
EQUITY SEGMENT YIELD	0.78	1.07
EQUITY SEGMENT P/E	16.27	17.19
EQUITY SEGMENT BETA	1.33	1.28
PRICE/BOOK RATIO	2.72	3.10
FIVE YEAR EARNINGS GROWTH	8.42	9.25
RETURN ON EQUITY	13.61	11.30

TEN LARGEST HOLDINGS

TEN BEST PERFORMERS

TEN WORST PERFORMERS

<u>NAME</u>	<u>\$</u>	<u>WEIGHT</u>	<u>NAME</u>	<u>RETURN</u>	<u>NAME</u>	<u>RETURN</u>
RTI INTL METALS INC	388,887	1.4	TODCO	67.6	KINDRED HEALTHCARE	- 24.8
OMI CORP NEW	354,980	1.3	HANGER ORTHOPEDIC C	52.8	CARMIKE CINEMAS INC	- 24.7
OREGON STL MLS INC	330,737	1.2	CLEVELAND CLIFFS IN	51.2	SWIFT TRANSN INC	- 24.0
INTEGRATED DEVICE T	329,498	1.2	OIL STS INTL INC	44.3	FINISH LINE INC	- 22.7
SAFENET INC	328,291	1.2	RANGE RES CORP	43.6	ALLIANCE GAMING COR	- 22.6
ADVO INC	314,137	1.2	BRIGHAM EXPL CO	40.7	DICKS SPORTING GOOD	- 22.0
LIFEPOINT HOSPS INC	309,881	1.1	AIRTRAN HLDGS INC	37.2	FOSSIL INC	- 19.9
STEEL DYNAMICS INC	296,398	1.1	VERITAS DOC INC	32.0	COHERENT INC COM	- 18.7
LIBERTY CORP COM	292,045	1.1	DOT HILL SYS CORP	28.4	WABASH NATL CORP	- 18.7
DRESSER-RAND GROUP	291,364	1.1	LIBERTY CORP COM	28.1	BANKUNITED FINL COR	- 15.4

VERMONT MUNICIPAL EMPLOYEES

EQUITY FUNDS ONLY - CAPITAL MARKET LINE

3 YEARS ENDING 9/05

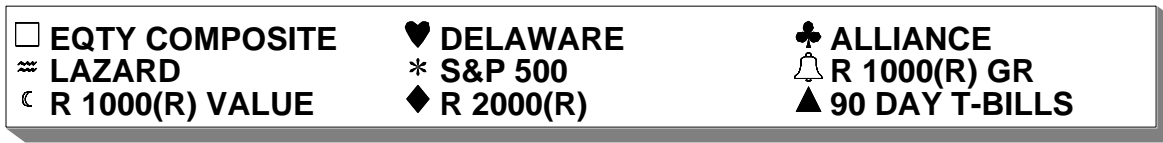
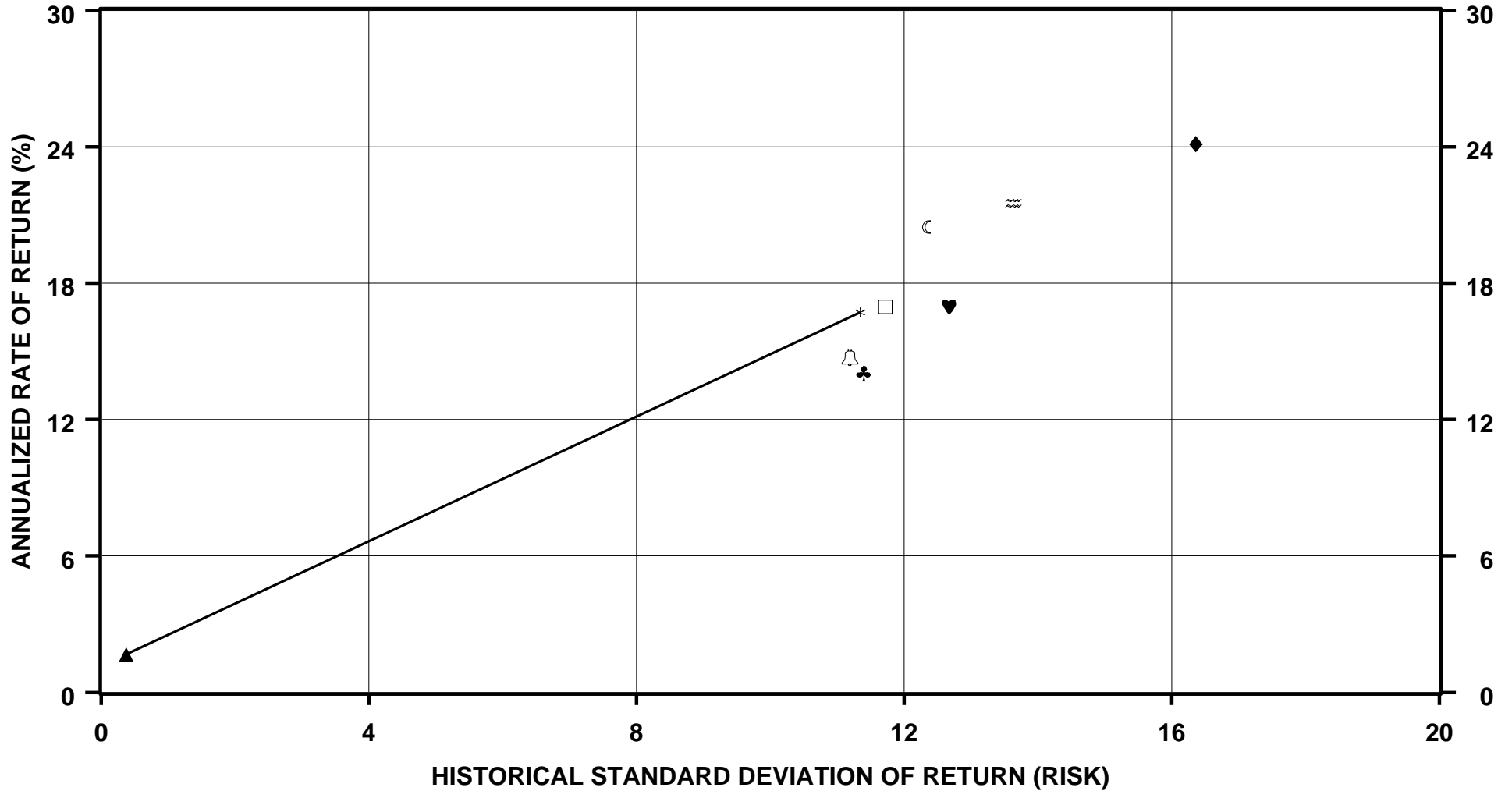

VERMONT MUNICIPAL EMPLOYEES

EQUITY FUNDS ONLY - CAPITAL MARKET LINE

5 YEARS ENDING 9/05

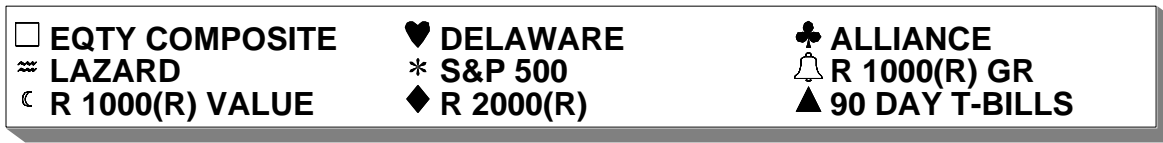
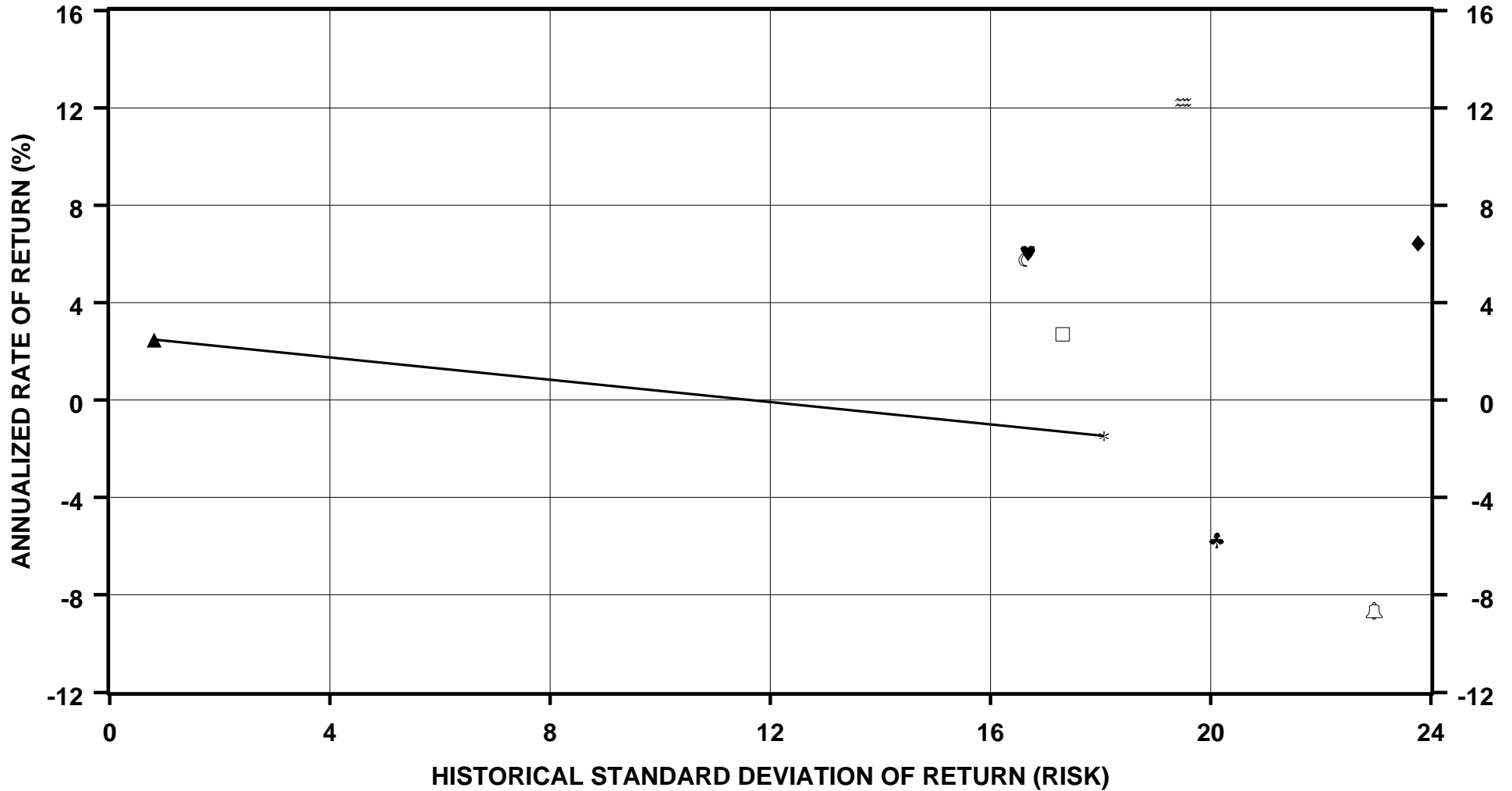

VERMONT MUNICIPAL EMPLOYEES

EQUITY PORTFOLIO CHARACTERISTICS

PERIODS ENDING 9/05

DIVIDEND YIELD

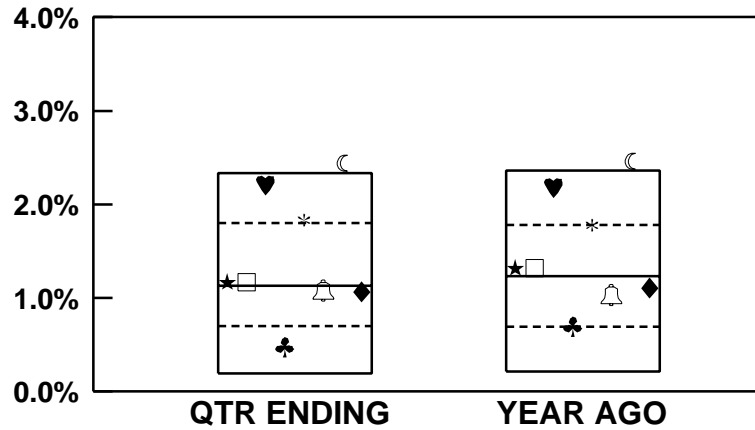

CAPITALIZATION

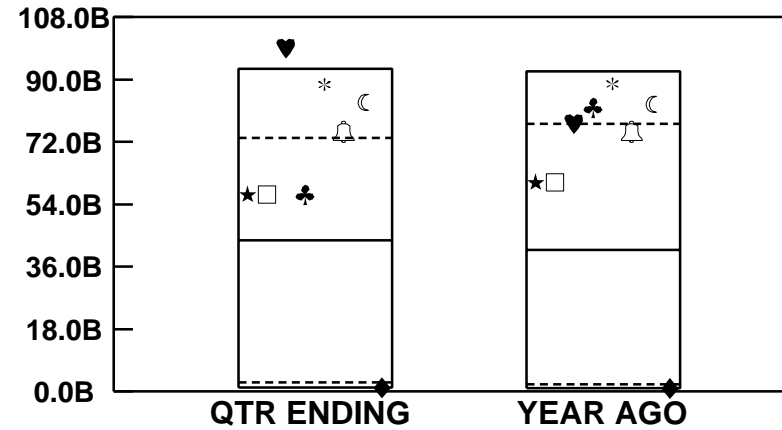

EFFECTS ON RETURN

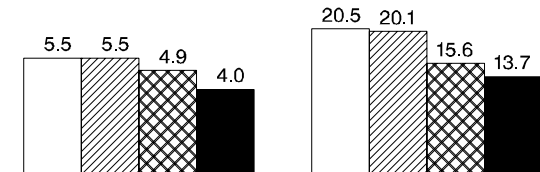
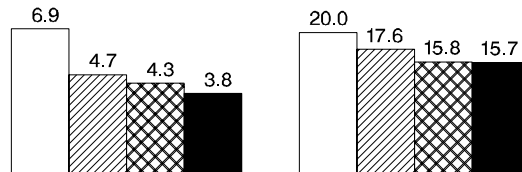
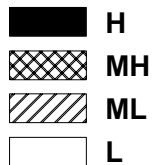

★ MUNI COMPOSITE	1.17	48	1.32	46	56.90	39	60.40	38
□ EQTY COMPOSITE	1.17	48	1.32	46	56.90	39	60.42	38
♥ DELAWARE	2.21	7	2.18	8	99.24	3	77.46	24
♣ ALLIANCE	0.48	82	0.70	74	56.88	39	82.07	19
* S&P 500	1.83	18	1.78	20	88.71	14	88.75	13
🔔 R 1000(R) GR	1.08	53	1.03	58	74.93	23	75.03	26
☾ R 1000(R) VALUE	2.44	3	2.46	3	83.47	18	82.95	18
◆ R 2000(R)	1.07	53	1.11	54	1.07	95	0.91	95
MEDIAN	1.13		1.23		43.55		40.86	

VERMONT MUNICIPAL EMPLOYEES

EQUITY PORTFOLIO CHARACTERISTICS

PERIODS ENDING 9/05

DIVIDEND YIELD

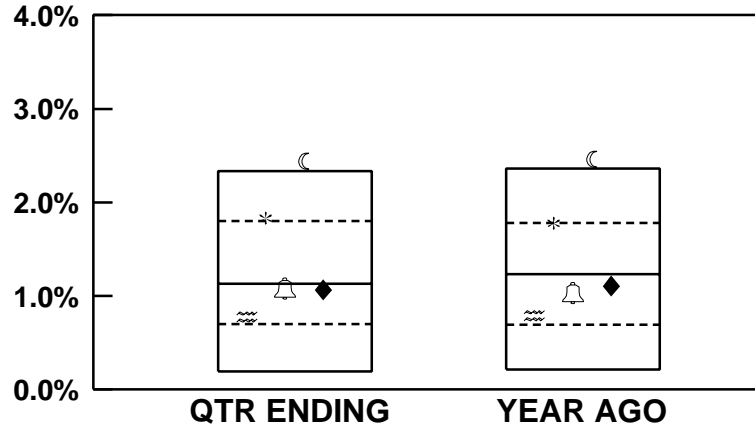

CAPITALIZATION

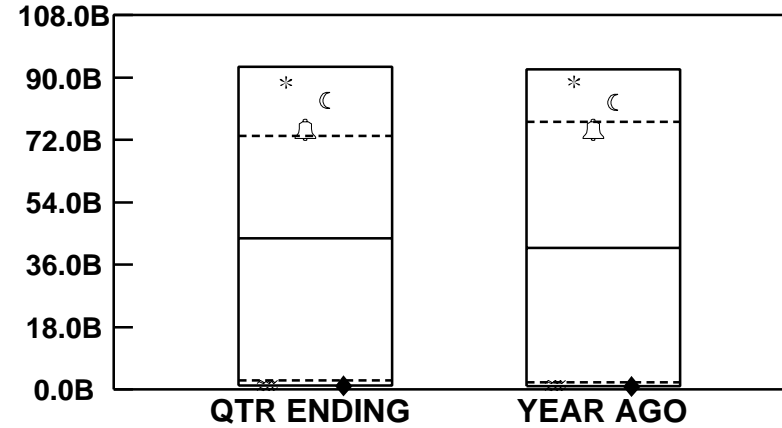

EFFECTS ON RETURN

- H
- MH
- ML
- L

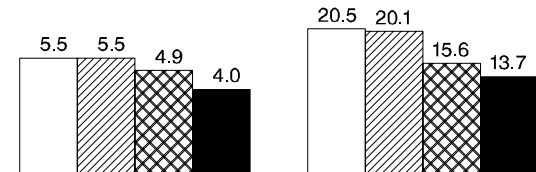
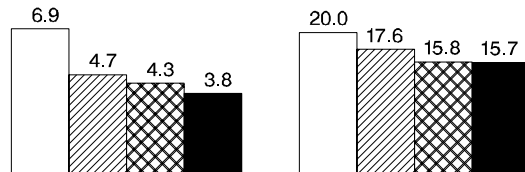

	QTR ENDING	YEAR AGO	QTR ENDING	YEAR AGO
LAZARD	0.78	69	0.79	70
S&P 500	1.83	18	1.78	20
R 1000(R) GR	1.08	53	1.03	58
R 1000(R) VALUE	2.44	3	2.46	3
R 2000(R)	1.07	53	1.11	54
MEDIAN	1.13	1.23	43.55	40.86

VERMONT MUNICIPAL EMPLOYEES

EQUITY PORTFOLIO CHARACTERISTICS

PERIODS ENDING 9/05

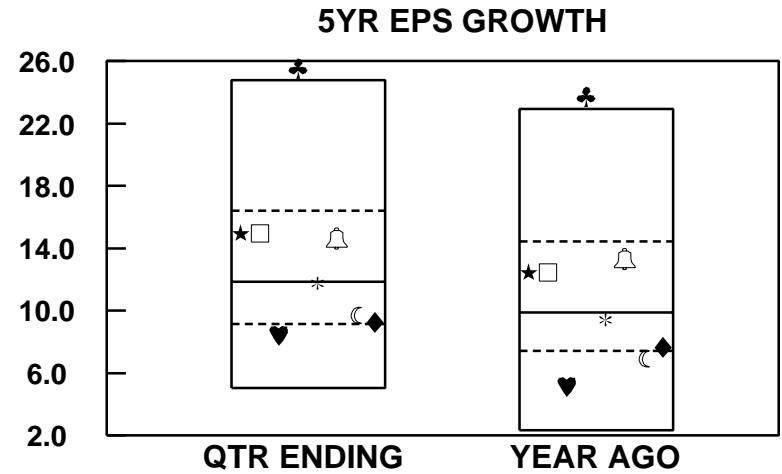
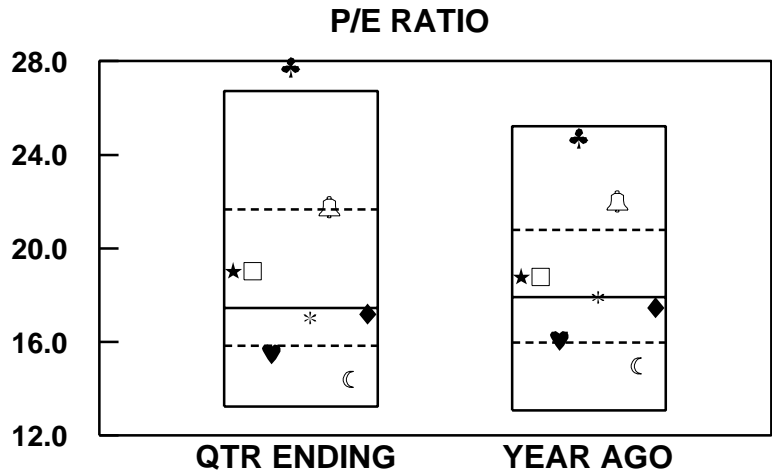

EFFECTS ON RETURN

- H
- MH
- ML
- L

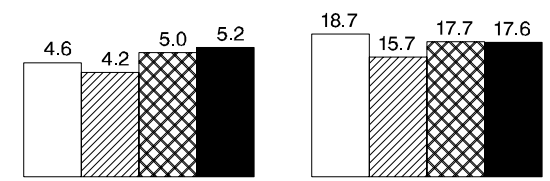
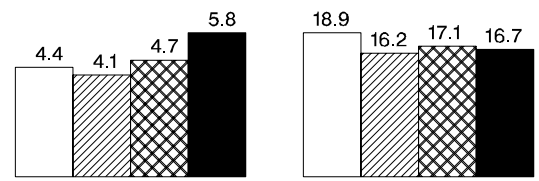

★ MUNI COMPOSITE	19.02	36	18.78	38	14.96	29	12.45	33
□ EQTY COMPOSITE	19.02	36	18.78	38	14.96	29	12.45	33
♥ DELAWARE	15.51	78	16.08	74	8.43	80	5.14	83
♣ ALLIANCE	27.75	3	24.73	6	25.54	3	23.76	4
* S&P 500	17.02	60	17.92	46	11.75	54	9.42	56
🔔 R 1000(R) GR	21.77	24	22.00	18	14.66	30	13.33	29
☾ R 1000(R) VALUE	14.39	86	14.99	84	9.71	70	6.90	77
◆ R 2000(R)	17.19	53	17.48	57	9.28	73	7.68	73
MEDIAN	17.46		17.92		11.85		9.88	

VERMONT MUNICIPAL EMPLOYEES

EQUITY PORTFOLIO CHARACTERISTICS

PERIODS ENDING 9/05

P/E RATIO

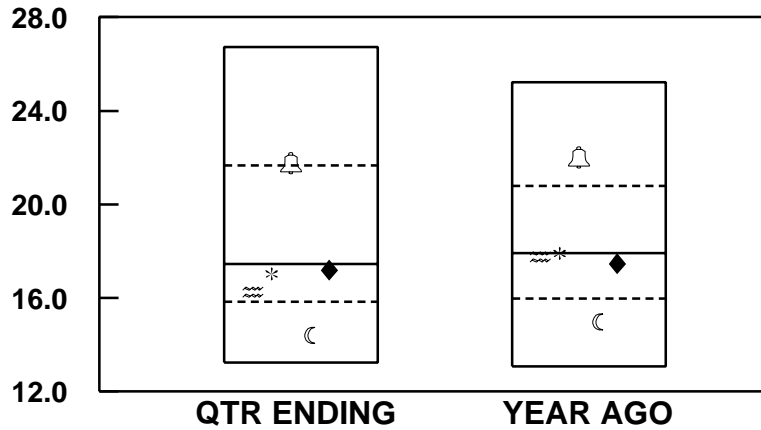

5YR EPS GROWTH

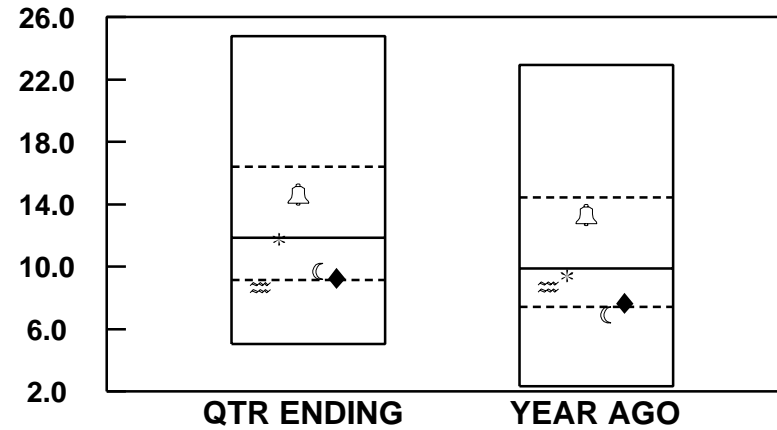

EFFECTS ON RETURN

- H
- MH
- ML
- L

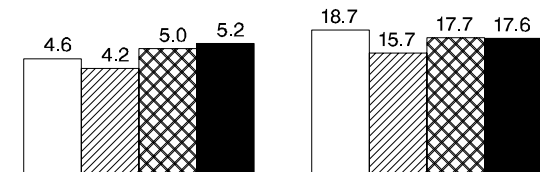
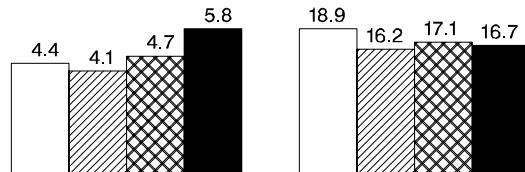

≈ LAZARD	16.27	70	17.77	54	8.67	78	8.73	66
* S&P 500	17.02	60	17.92	46	11.75	54	9.42	56
🔔 R 1000(R) GR	21.77	24	22.00	18	14.66	30	13.33	29
☾ R 1000(R) VALUE	14.39	86	14.99	84	9.71	70	6.90	77
◆ R 2000(R)	17.19	53	17.48	57	9.28	73	7.68	73
MEDIAN	17.46		17.92		11.85		9.88	

VERMONT MUNICIPAL EMPLOYEES

EQUITY PORTFOLIO CHARACTERISTICS

PERIODS ENDING 9/05

RETURN ON EQUITY

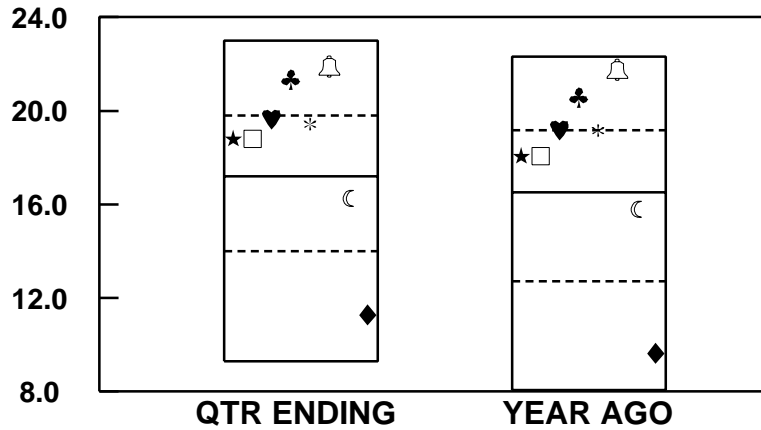

PRICE/BOOK

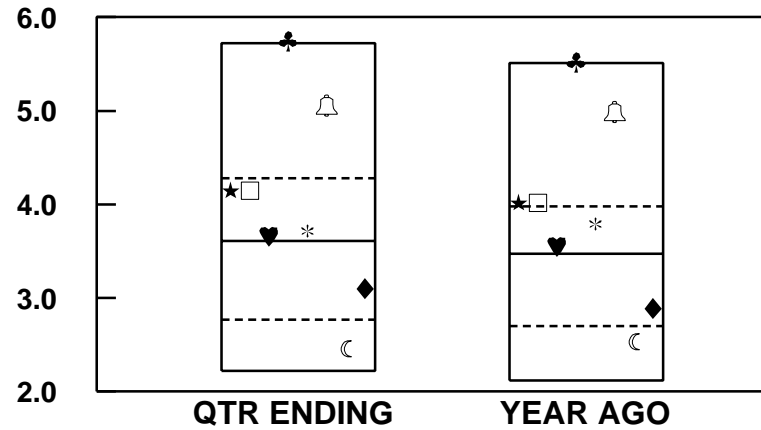

EFFECTS ON RETURN

- H
- MH
- ML
- L

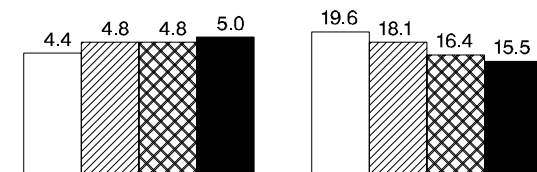
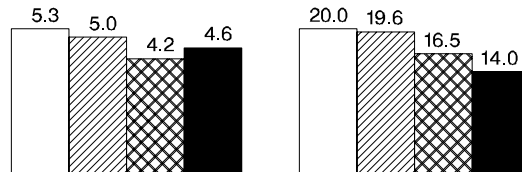

★ MUNI COMPOSITE	18.81	38	18.06	39	4.15	28	4.02	23
□ EQTY COMPOSITE	18.81	38	18.06	39	4.15	28	4.02	23
♥ DELAWARE	19.65	25	19.18	21	3.66	48	3.55	48
♣ ALLIANCE	21.36	13	20.58	10	5.75	4	5.52	4
* S&P 500	19.44	33	19.15	27	3.72	40	3.79	38
🔔 R 1000(R) GR	21.89	9	21.77	6	5.06	11	4.99	9
☾ R 1000(R) VALUE	16.27	58	15.78	56	2.46	88	2.53	80
◆ R 2000(R)	11.29	90	9.65	91	3.10	63	2.89	65
MEDIAN	17.20		16.51		3.61		3.47	

VERMONT MUNICIPAL EMPLOYEES

EQUITY PORTFOLIO CHARACTERISTICS

PERIODS ENDING 9/05

RETURN ON EQUITY

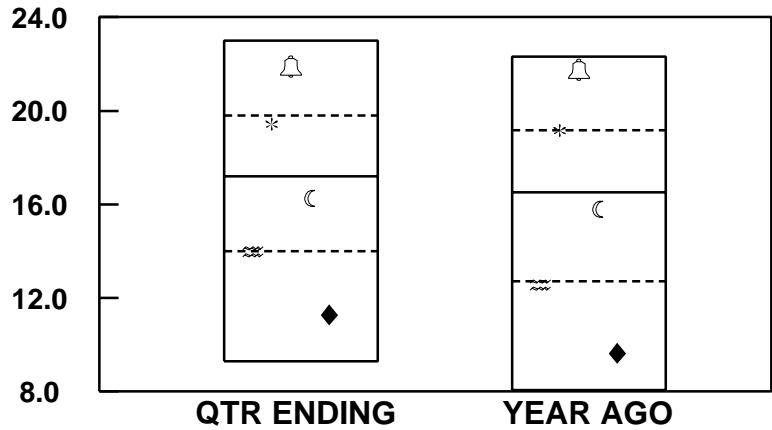

PRICE/BOOK

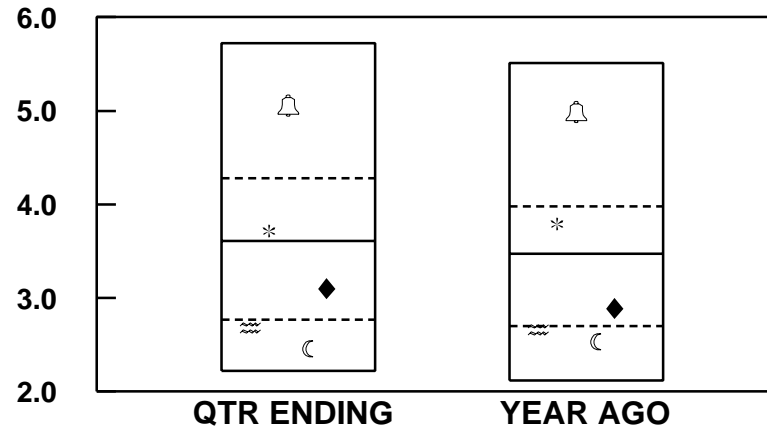

EFFECTS ON RETURN

- H
- MH
- ML
- L

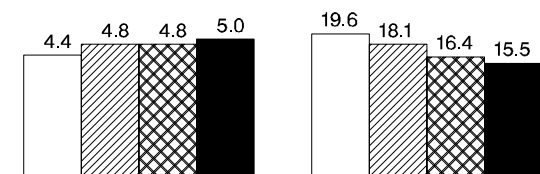
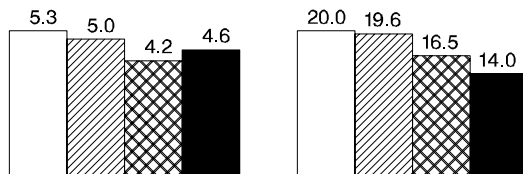

≈ LAZARD	13.98	75	12.56	76	2.68	77	2.66	76
* S&P 500	19.44	33	19.15	27	3.72	40	3.79	38
🔔 R 1000(R) GR	21.89	9	21.77	6	5.06	11	4.99	9
☾ R 1000(R) VALUE	16.27	58	15.78	56	2.46	88	2.53	80
◆ R 2000(R)	11.29	90	9.65	91	3.10	63	2.89	65
MEDIAN	17.20		16.51		3.61		3.47	

VERMONT MUNICIPAL EMPLOYEES

EQUITY PORTFOLIO CHARACTERISTICS

PERIODS ENDING 9/05

PORTFOLIO BETA

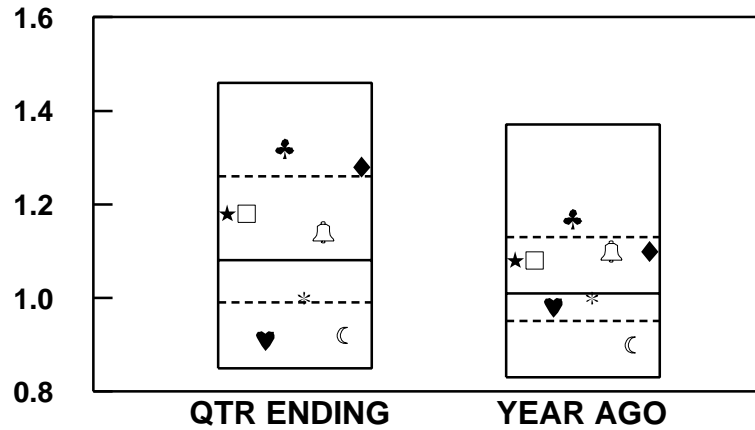

SIZE EXPOSURE

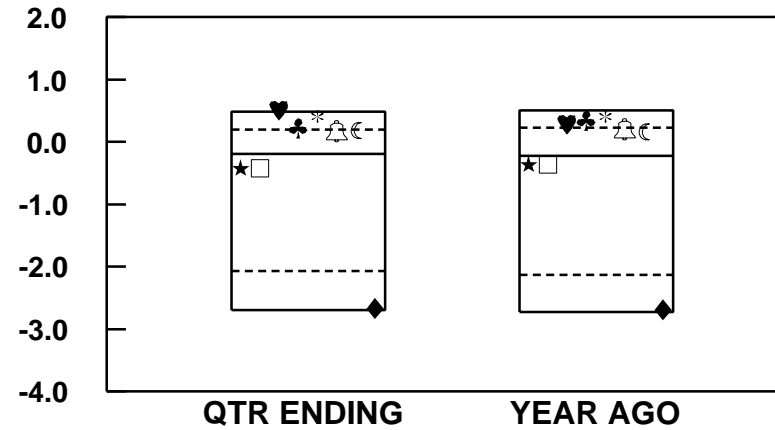

EFFECTS ON RETURN

- H
- MH
- ML
- L

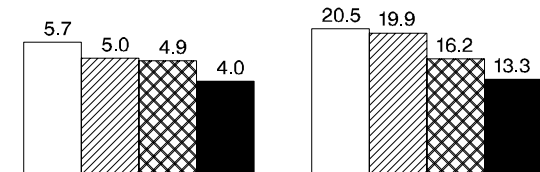
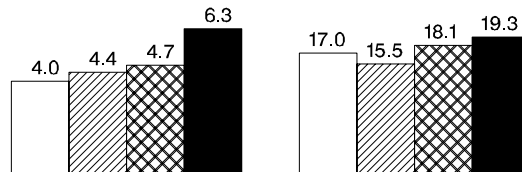

★ MUNI COMPOSITE	1.18	36	1.08	31	-0.42	54	-0.36	53
□ EQTY COMPOSITE	1.18	36	1.08	31	-0.42	54	-0.36	53
♥ DELAWARE	0.91	90	0.98	67	0.51	4	0.29	21
♣ ALLIANCE	1.32	15	1.17	21	0.23	23	0.35	18
* S&P 500	1.00	68	1.00	56	0.41	7	0.41	13
🔔 R 1000(R) GR	1.14	41	1.10	29	0.18	26	0.21	26
☾ R 1000(R) VALUE	0.92	90	0.90	85	0.18	27	0.16	30
◆ R 2000(R)	1.28	21	1.10	30	-2.67	94	-2.69	94
MEDIAN	1.08		1.01		-0.19		-0.22	

VERMONT MUNICIPAL EMPLOYEES

EQUITY PORTFOLIO CHARACTERISTICS

PERIODS ENDING 9/05

PORTFOLIO BETA

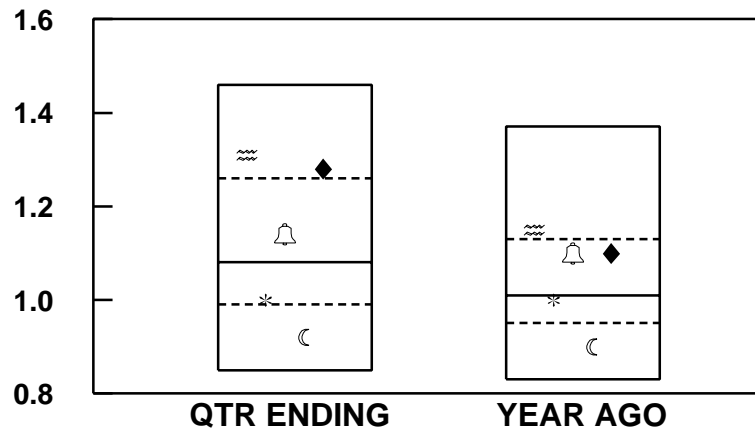

SIZE EXPOSURE

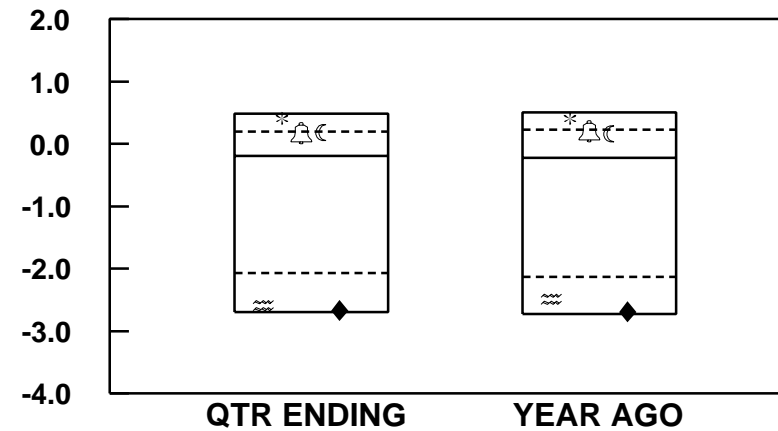

EFFECTS ON RETURN

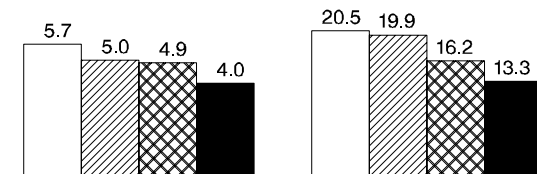
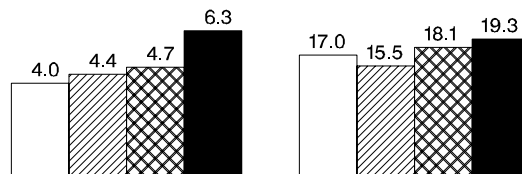
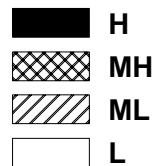

≈ LAZARD	1.31	18	1.15	23	-2.59	91	-2.49	86
* S&P 500	1.00	68	1.00	56	0.41	7	0.41	13
🔔 R 1000(R) GR	1.14	41	1.10	29	0.18	26	0.21	26
☾ R 1000(R) VALUE	0.92	90	0.90	85	0.18	27	0.16	30
◆ R 2000(R)	1.28	21	1.10	30	-2.67	94	-2.69	94
MEDIAN	1.08		1.01		-0.19		-0.22	

VERMONT MUNICIPAL EMPLOYEES

EQUITY PORTFOLIO CHARACTERISTICS

PERIODS ENDING 9/05

EQUITY R2

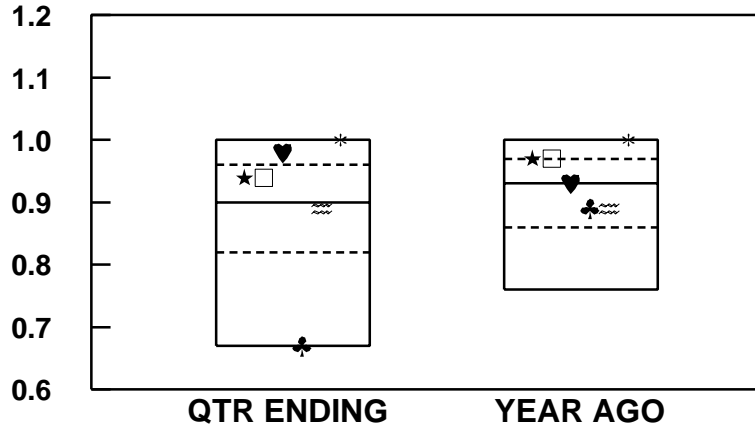

STANDARD ERROR

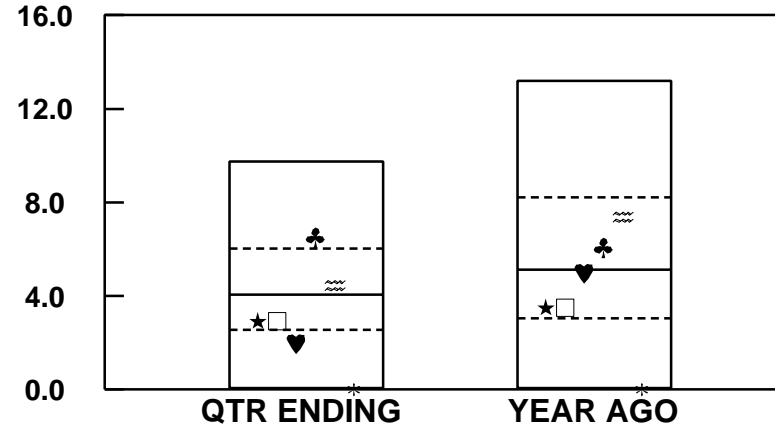

EFFECTS ON RETURN

- H
- MH
- ML
- L

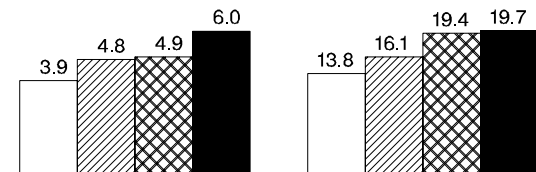
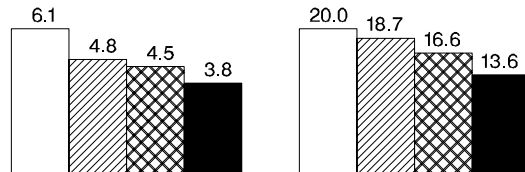

★ MUNI COMPOSITE	0.94	35	0.97	28	2.92	68	3.49	70
□ EQTY COMPOSITE	0.94	35	0.97	28	2.92	68	3.49	70
♥ DELAWARE	0.98	18	0.93	47	1.98	80	4.97	51
♣ ALLIANCE	0.67	94	0.89	63	6.50	21	6.06	40
≈ LAZARD	0.89	53	0.89	67	4.46	45	7.37	32
* S&P 500	1.00	1	1.00	1	0.00		0.00	
MEDIAN	0.90		0.93		4.05		5.12	

VERMONT MUNICIPAL EMPLOYEES

EQUITY PORTFOLIO CHARACTERISTICS

PERIODS ENDING 9/05

FINANCIAL LEVERAGE

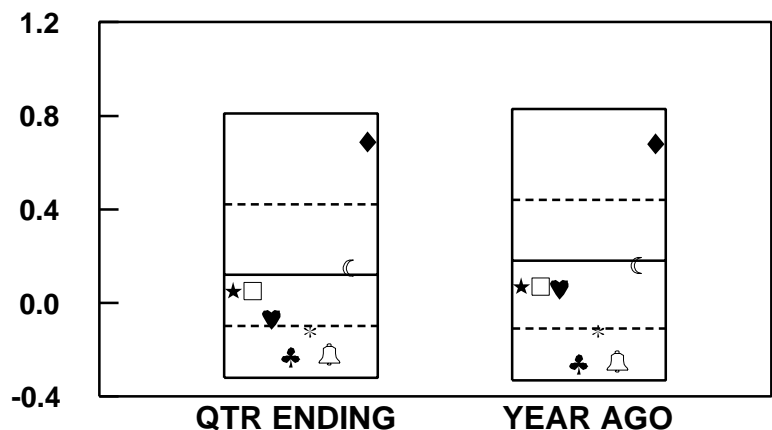

GROWTH EXPOSURE

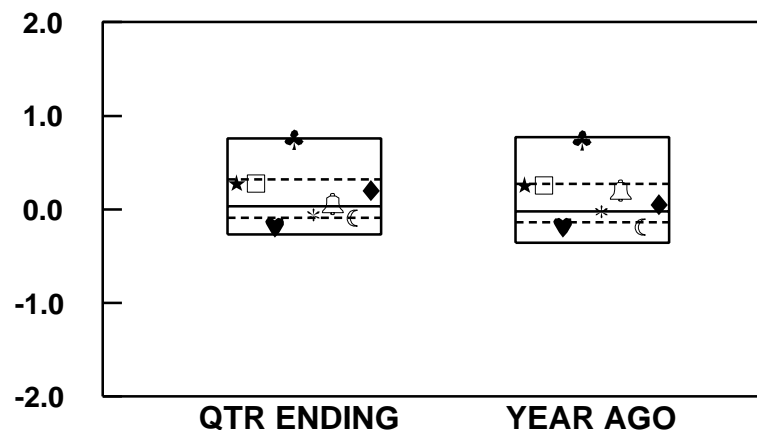

EFFECTS ON RETURN

- H
- MH
- ML
- L

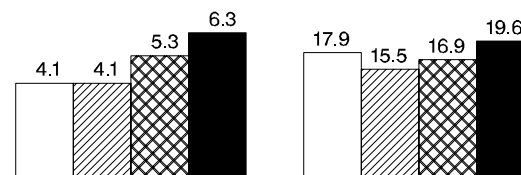
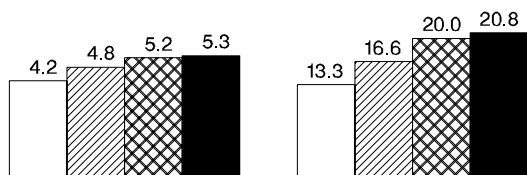

★ MUNI COMPOSITE	0.05	56	0.07	59	0.28	27	0.26	26
□ EQTY COMPOSITE	0.05	56	0.07	59	0.28	27	0.26	26
♥ DELAWARE	-0.07	70	0.06	60	-0.19	87	-0.19	80
♣ ALLIANCE	-0.23	89	-0.26	91	0.75	5	0.74	5
* S&P 500	-0.12	77	-0.12	75	-0.06	70	-0.02	57
🔔 R 1000(R) GR	-0.22	88	-0.25	91	0.06	45	0.20	30
☾ R 1000(R) VALUE	0.15	47	0.16	51	-0.09	74	-0.19	79
◆ R 2000(R)	0.69	9	0.68	11	0.20	33	0.05	41
MEDIAN	0.12		0.18		0.03		-0.02	

VERMONT MUNICIPAL EMPLOYEES

EQUITY PORTFOLIO CHARACTERISTICS

PERIODS ENDING 9/05

FINANCIAL LEVERAGE

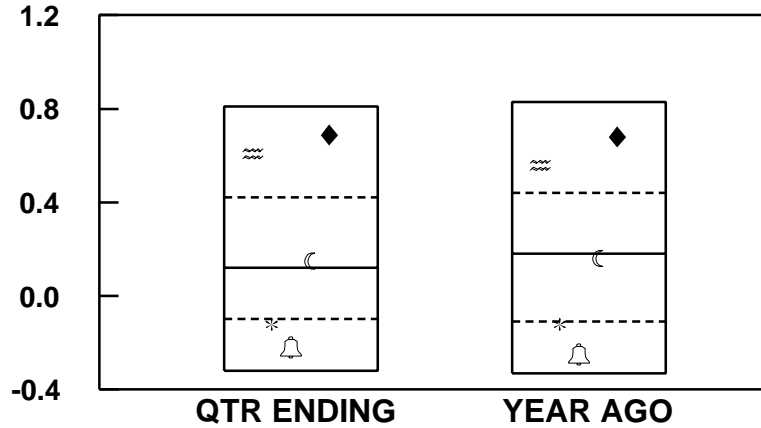

GROWTH EXPOSURE

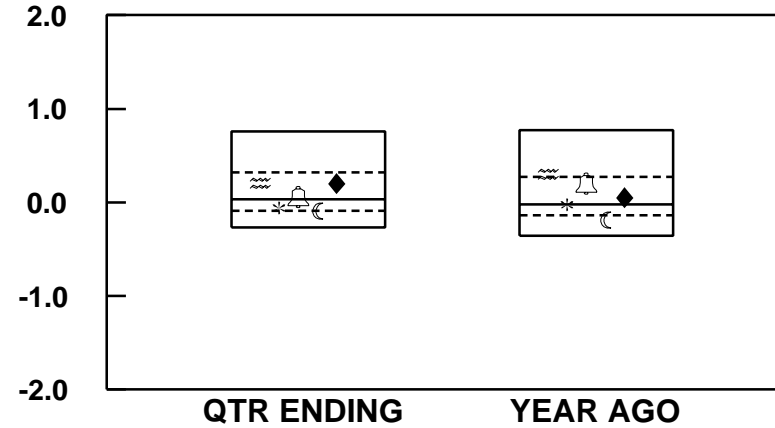

EFFECTS ON RETURN

- H
- MH
- ML
- L

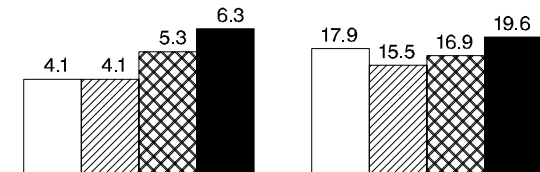
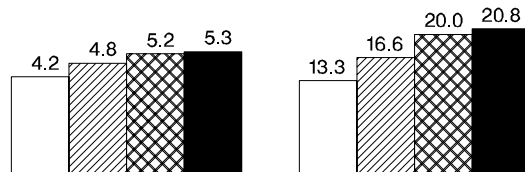

	QTR ENDING	YEAR AGO	QTR ENDING	YEAR AGO
≈ LAZARD	0.61	12	0.56	16
* S&P 500	-0.12	77	-0.12	75
🔔 R 1000(R) GR	-0.22	88	-0.25	91
☾ R 1000(R) VALUE	0.15	47	0.16	51
◆ R 2000(R)	0.69	9	0.68	11
MEDIAN	0.12	0.18	0.03	-0.02

VERMONT MUNICIPAL EMPLOYEES

DOMESTIC EQUITY ONLY PORTFOLIO CHARACTERISTICS

PERIODS ENDING 9/05

DIVIDEND YIELD

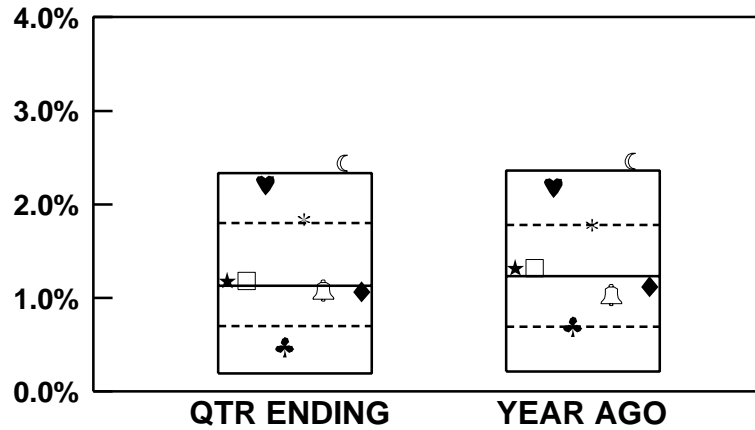

CAPITALIZATION

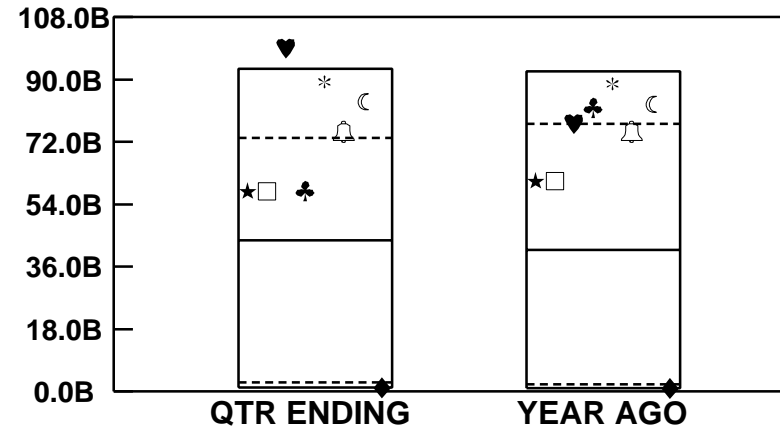

EFFECTS ON RETURN

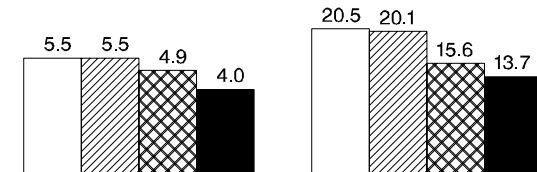
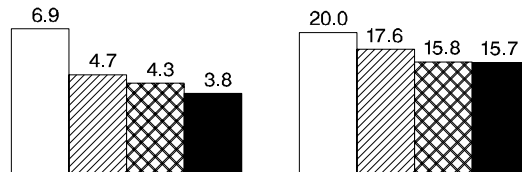
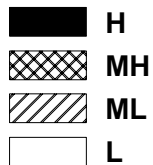

★ MUNI COMPOSITE	1.18	47	1.32	45	57.87	38	60.68	38
□ EQTY COMPOSITE	1.18	47	1.32	45	57.87	38	60.68	38
♥ DELAWARE	2.21	7	2.18	8	99.24	3	77.46	24
♣ ALLIANCE	0.48	82	0.70	74	57.94	38	82.07	19
* S&P 500	1.84	17	1.78	20	89.46	8	88.75	13
🔔 R 1000(R) GR	1.08	53	1.03	58	74.97	23	75.03	26
☾ R 1000(R) VALUE	2.44	3	2.46	3	83.57	18	82.95	18
◆ R 2000(R)	1.07	53	1.12	54	1.06	95	0.91	95
MEDIAN	1.13		1.23		43.55		40.86	

VERMONT MUNICIPAL EMPLOYEES

DOMESTIC EQUITY ONLY PORTFOLIO CHARACTERISTICS

PERIODS ENDING 9/05

DIVIDEND YIELD

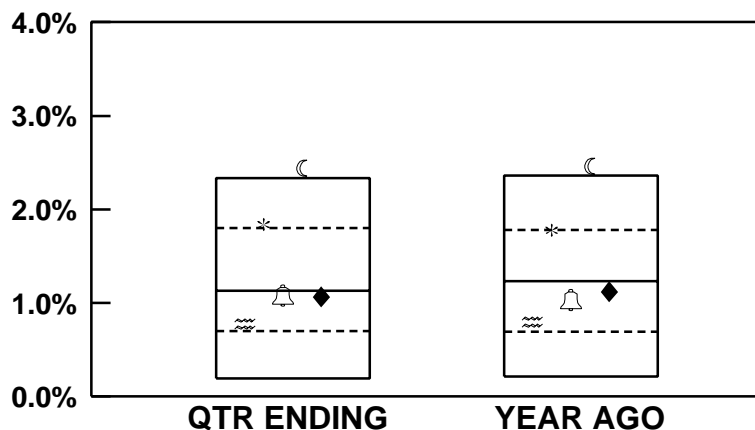

CAPITALIZATION

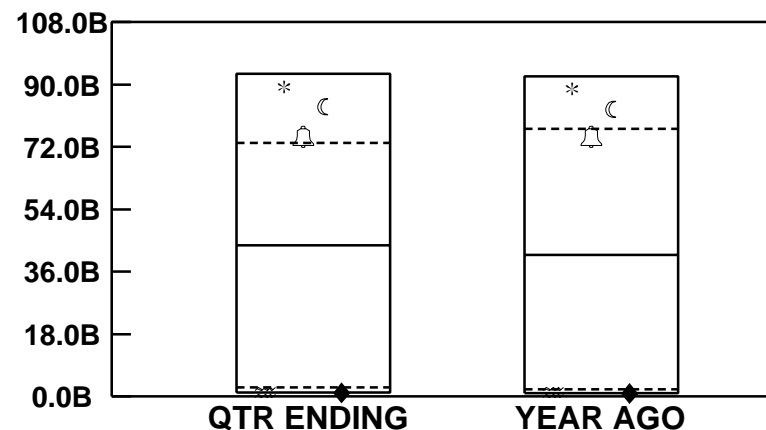

EFFECTS ON RETURN

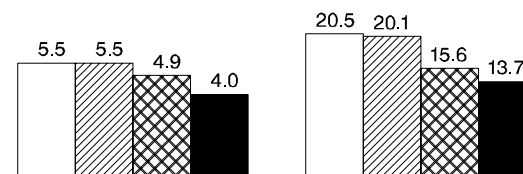
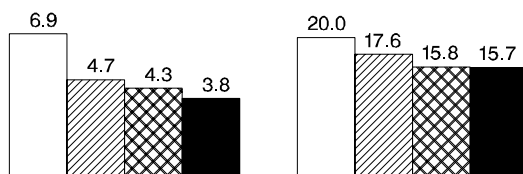
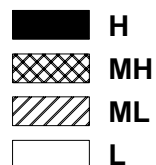

≈ LAZARD	0.78	69	0.80	70	1.16	94	1.16	88
* S&P 500	1.84	17	1.78	20	89.46	8	88.75	13
🔔 R 1000(R) GR	1.08	53	1.03	58	74.97	23	75.03	26
☾ R 1000(R) VALUE	2.44	3	2.46	3	83.57	18	82.95	18
◆ R 2000(R)	1.07	53	1.12	54	1.06	95	0.91	95
MEDIAN	1.13		1.23		43.55		40.86	

VERMONT MUNICIPAL EMPLOYEES

DOMESTIC EQUITY ONLY PORTFOLIO CHARACTERISTICS

PERIODS ENDING 9/05

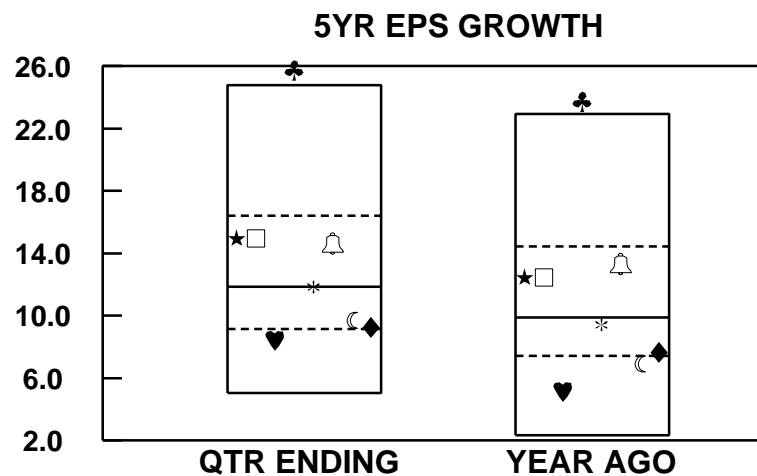
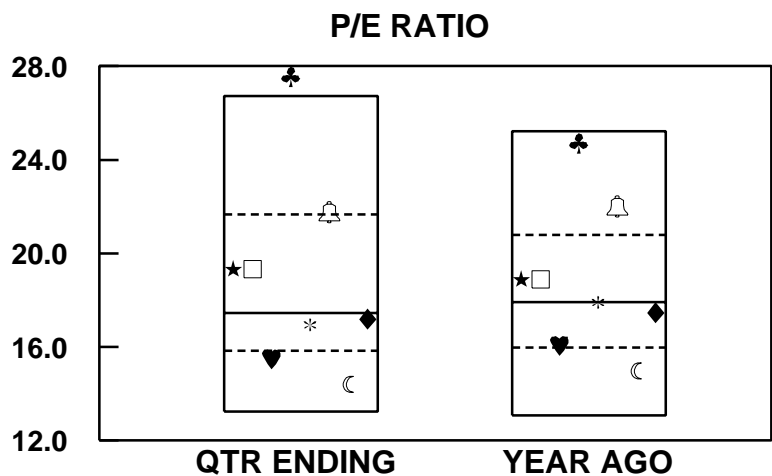

EFFECTS ON RETURN

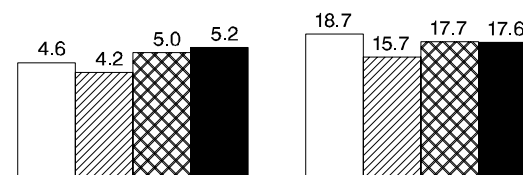
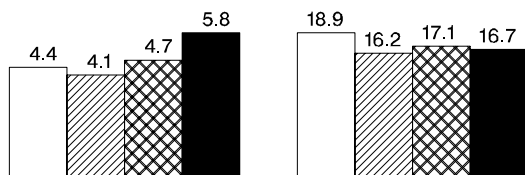
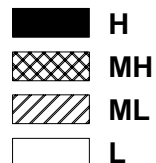

★ MUNI COMPOSITE	19.32	35	18.90	38	14.96	29	12.45	33
□ EQTY COMPOSITE	19.32	35	18.90	38	14.96	29	12.45	33
♥ DELAWARE	15.51	78	16.08	74	8.43	80	5.14	83
♣ ALLIANCE	27.58	3	24.73	6	25.77	3	23.76	4
* S&P 500	16.96	62	17.92	46	11.86	49	9.42	56
🔔 R 1000(R) GR	21.78	24	22.00	18	14.64	31	13.33	29
☾ R 1000(R) VALUE	14.39	86	14.99	84	9.71	70	6.90	77
◆ R 2000(R)	17.19	53	17.46	57	9.25	74	7.68	73
MEDIAN	17.46		17.92		11.85		9.88	

VERMONT MUNICIPAL EMPLOYEES

DOMESTIC EQUITY ONLY PORTFOLIO CHARACTERISTICS

PERIODS ENDING 9/05

P/E RATIO

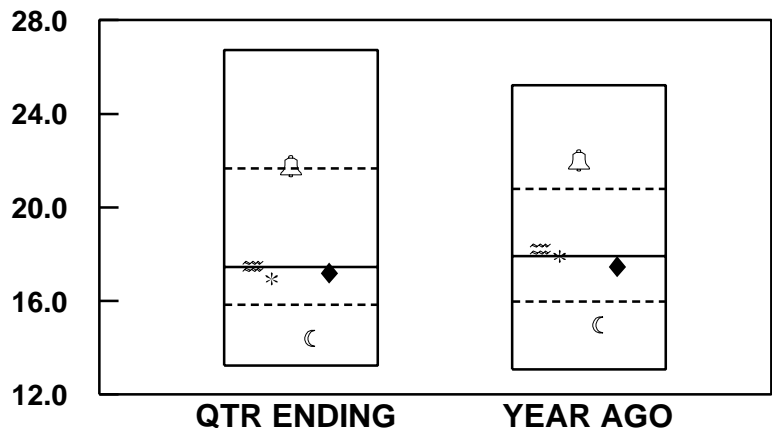

5YR EPS GROWTH

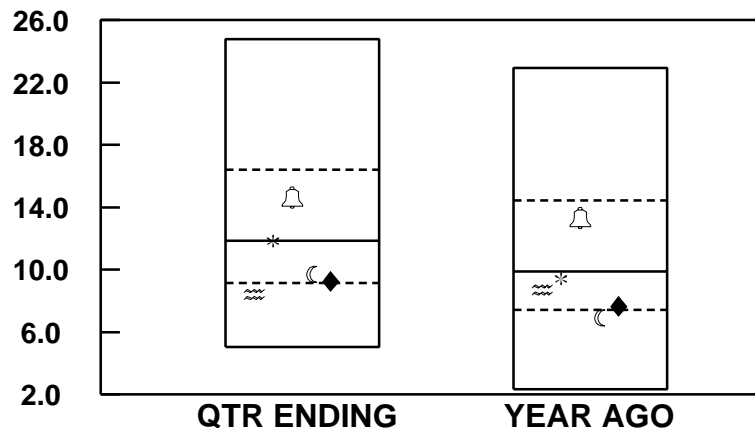

EFFECTS ON RETURN

- H
- MH
- ML
- L

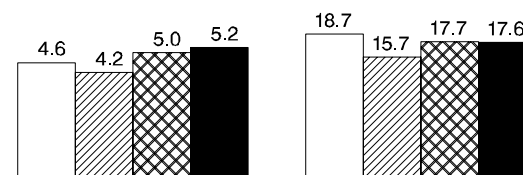
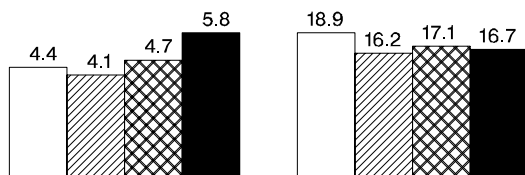

≈ LAZARD	17.50	49	18.24	42	8.42	80	8.73	66
* S&P 500	16.96	62	17.92	46	11.86	49	9.42	56
🔔 R 1000(R) GR	21.78	24	22.00	18	14.64	31	13.33	29
☾ R 1000(R) VALUE	14.39	86	14.99	84	9.71	70	6.90	77
◆ R 2000(R)	17.19	53	17.46	57	9.25	74	7.68	73
MEDIAN	17.46		17.92		11.85		9.88	

VERMONT MUNICIPAL EMPLOYEES

DOMESTIC EQUITY ONLY PORTFOLIO CHARACTERISTICS

PERIODS ENDING 9/05

RETURN ON EQUITY

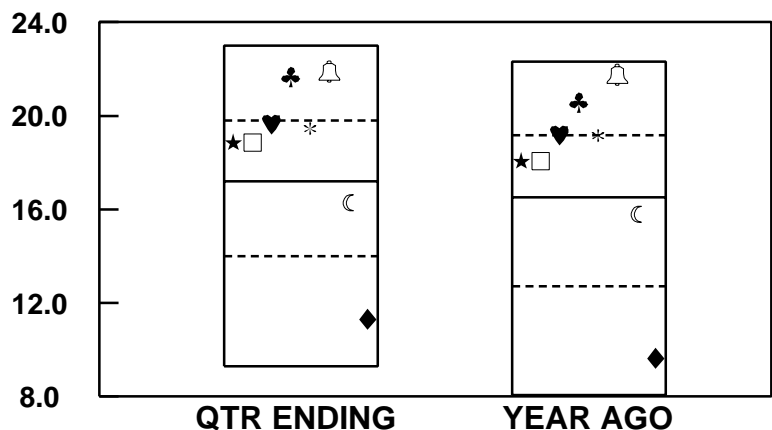

PRICE/BOOK

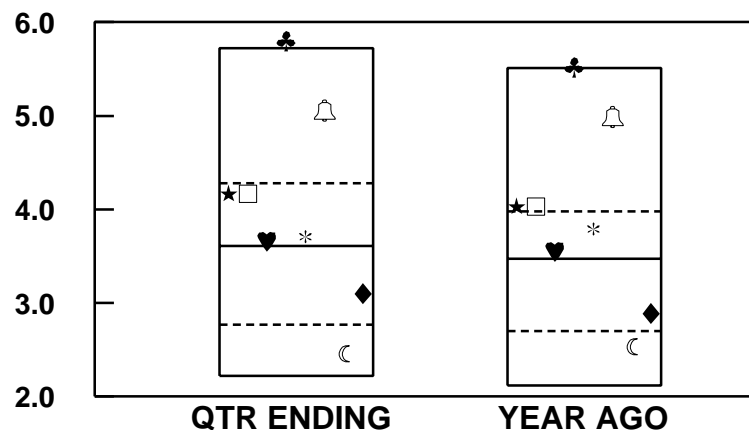

EFFECTS ON RETURN

- H
- MH
- ML
- L

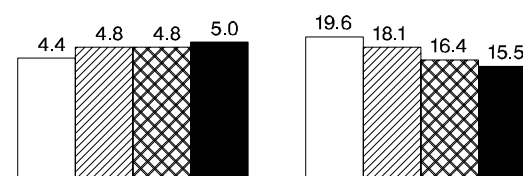
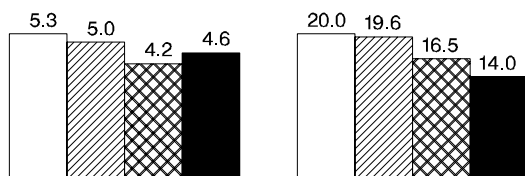

★ MUNI COMPOSITE	18.86	38	18.07	39	4.17	27	4.03	23
□ EQTY COMPOSITE	18.86	38	18.07	39	4.17	27	4.03	23
♥ DELAWARE	19.65	25	19.18	21	3.66	48	3.55	48
♣ ALLIANCE	21.68	10	20.58	10	5.80	4	5.52	4
* S&P 500	19.47	27	19.15	27	3.71	45	3.79	38
🔔 R 1000(R) GR	21.89	10	21.77	6	5.06	11	4.99	9
☾ R 1000(R) VALUE	16.28	58	15.78	56	2.46	88	2.53	80
◆ R 2000(R)	11.30	90	9.65	91	3.10	63	2.89	65
MEDIAN	17.20		16.51		3.61		3.47	

VERMONT MUNICIPAL EMPLOYEES

DOMESTIC EQUITY ONLY PORTFOLIO CHARACTERISTICS

PERIODS ENDING 9/05

RETURN ON EQUITY

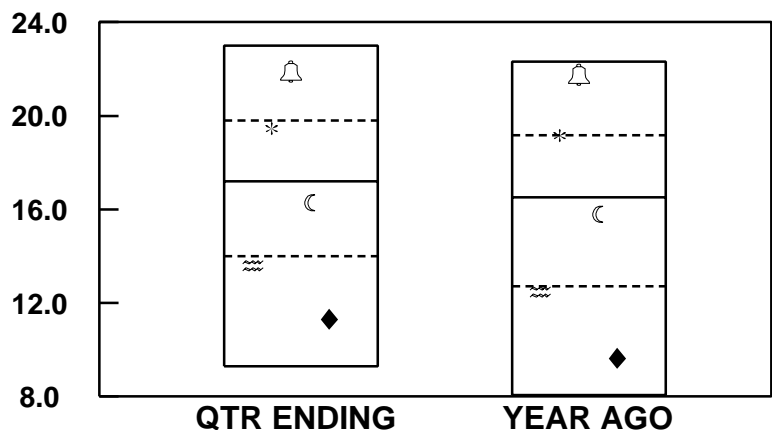

PRICE/BOOK

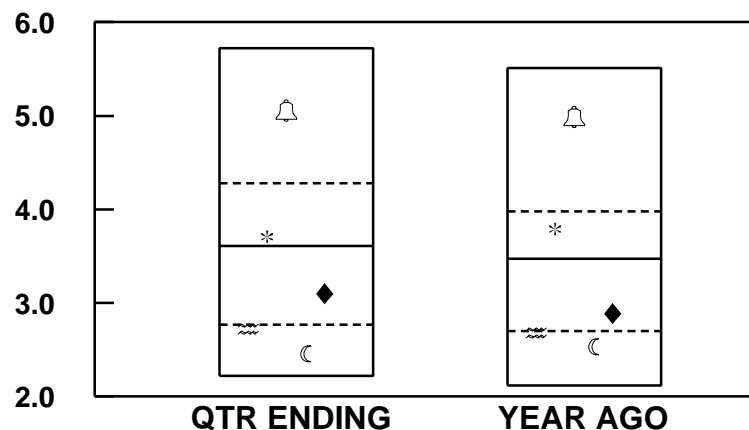

EFFECTS ON RETURN

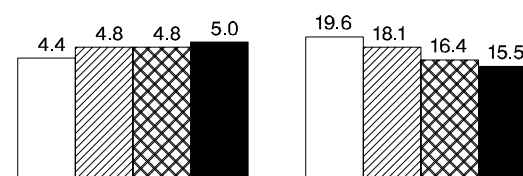
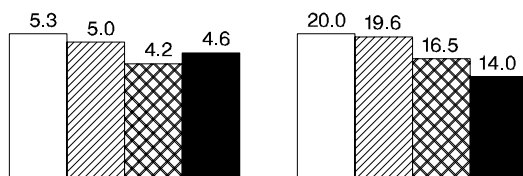
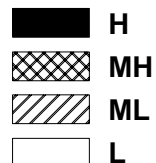

≈ LAZARD	13.61	77	12.49	78	2.72	76	2.68	76
* S&P 500	19.47	27	19.15	27	3.71	45	3.79	38
🔔 R 1000(R) GR	21.89	10	21.77	6	5.06	11	4.99	9
☾ R 1000(R) VALUE	16.28	58	15.78	56	2.46	88	2.53	80
◆ R 2000(R)	11.30	90	9.65	91	3.10	63	2.89	65
MEDIAN	17.20		16.51		3.61		3.47	

VERMONT MUNICIPAL EMPLOYEES

DOMESTIC EQUITY ONLY PORTFOLIO CHARACTERISTICS

PERIODS ENDING 9/05

PORTFOLIO BETA

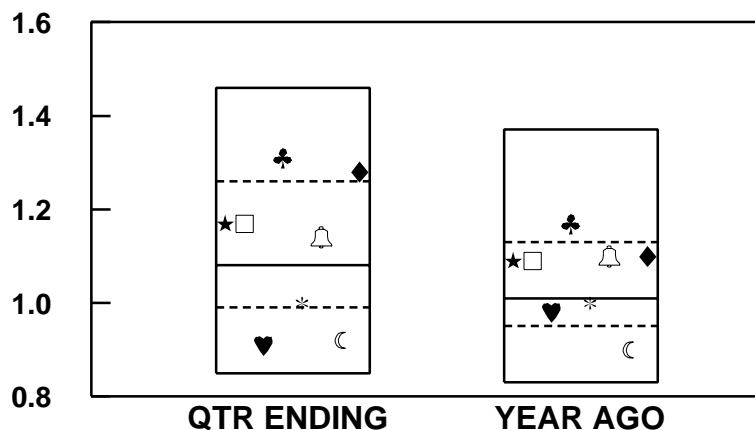

SIZE EXPOSURE

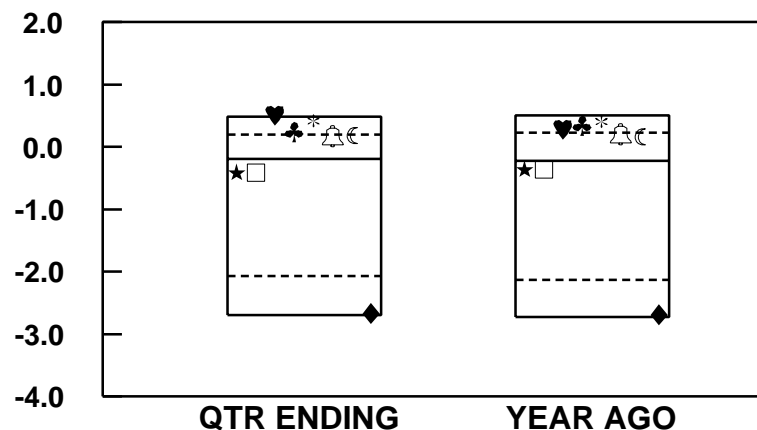

EFFECTS ON RETURN

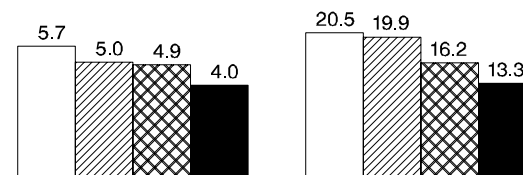
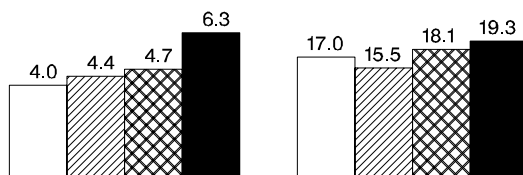
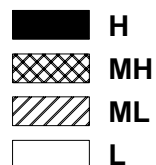

★ MUNI COMPOSITE	1.17	36	1.09	31	-0.41	54	-0.36	53
□ EQTY COMPOSITE	1.17	36	1.09	31	-0.41	54	-0.36	53
♥ DELAWARE	0.91	90	0.98	67	0.51	4	0.29	21
♣ ALLIANCE	1.31	18	1.17	21	0.25	21	0.35	18
* S&P 500	1.00	68	1.00	56	0.42	6	0.41	13
🔔 R 1000(R) GR	1.14	40	1.10	29	0.18	26	0.21	26
☾ R 1000(R) VALUE	0.92	90	0.90	85	0.18	26	0.16	30
◆ R 2000(R)	1.28	22	1.10	30	-2.67	94	-2.69	94
MEDIAN	1.08		1.01		-0.19		-0.22	

VERMONT MUNICIPAL EMPLOYEES

DOMESTIC EQUITY ONLY PORTFOLIO CHARACTERISTICS

PERIODS ENDING 9/05

PORTFOLIO BETA

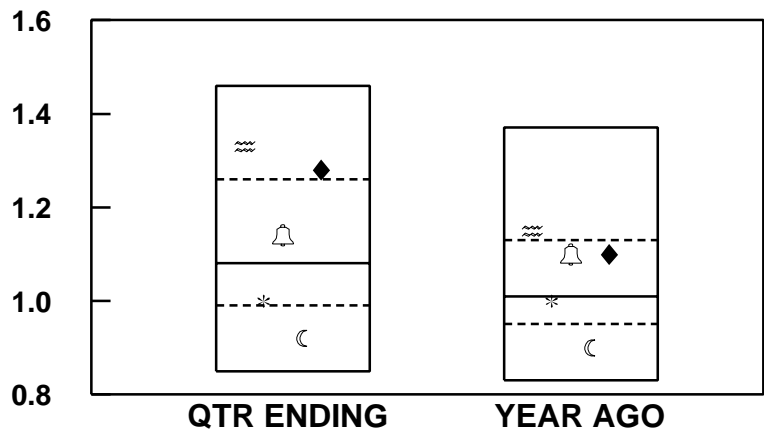

SIZE EXPOSURE

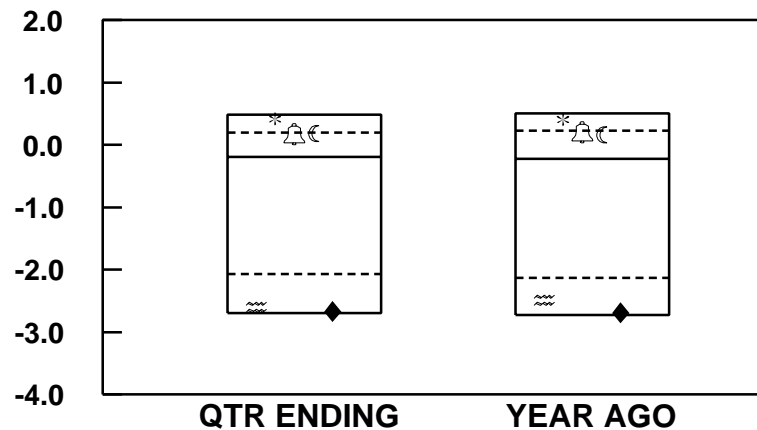

EFFECTS ON RETURN

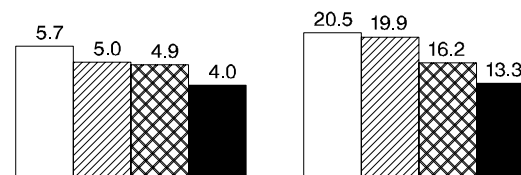
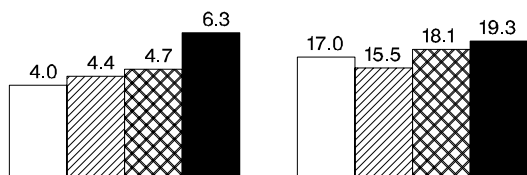
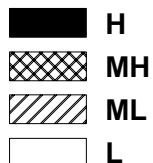

≈ LAZARD	1.33	15	1.15	22	-2.60	92	-2.49	86
* S&P 500	1.00	68	1.00	56	0.42	6	0.41	13
🔔 R 1000(R) GR	1.14	40	1.10	29	0.18	26	0.21	26
☾ R 1000(R) VALUE	0.92	90	0.90	85	0.18	26	0.16	30
◆ R 2000(R)	1.28	22	1.10	30	-2.67	94	-2.69	94
MEDIAN	1.08		1.01		-0.19		-0.22	

VERMONT MUNICIPAL EMPLOYEES

DOMESTIC EQUITY ONLY PORTFOLIO CHARACTERISTICS

PERIODS ENDING 9/05

EQUITY R2

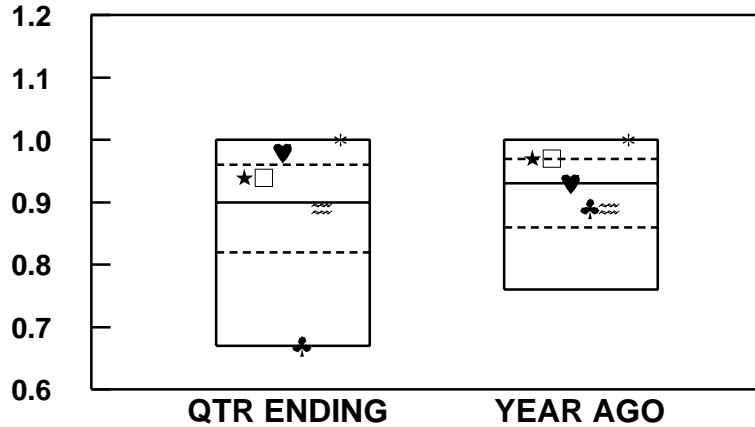

STANDARD ERROR

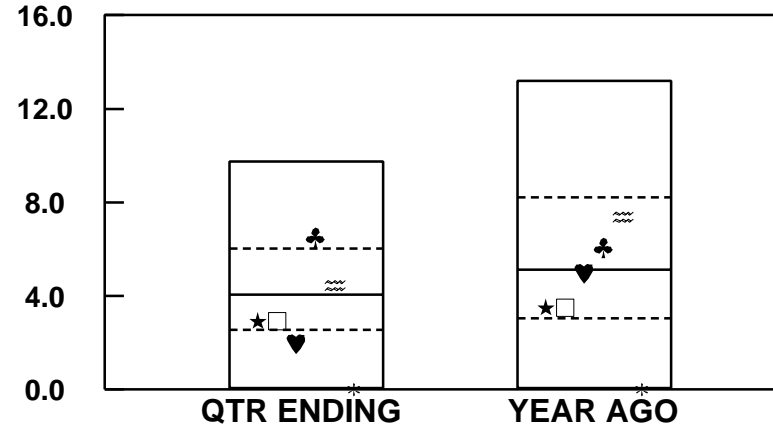

EFFECTS ON RETURN

- H
- MH
- ML
- L

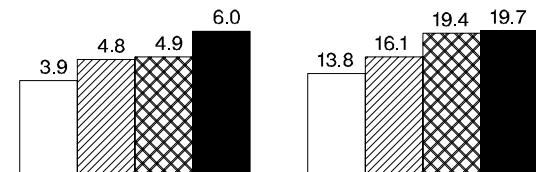
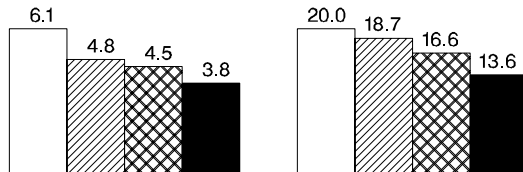

★ MUNI COMPOSITE	0.94	35	0.97	28	2.92	68	3.49	70
□ EQTY COMPOSITE	0.94	35	0.97	28	2.92	68	3.49	70
♥ DELAWARE	0.98	18	0.93	47	1.98	80	4.97	51
♣ ALLIANCE	0.67	94	0.89	63	6.50	21	6.06	40
≈ LAZARD	0.89	53	0.89	67	4.46	45	7.37	32
* S&P 500	1.00	1	1.00	1	0.00		0.00	
MEDIAN	0.90		0.93		4.05		5.12	

VERMONT MUNICIPAL EMPLOYEES

DOMESTIC EQUITY ONLY PORTFOLIO CHARACTERISTICS

PERIODS ENDING 9/05

FINANCIAL LEVERAGE

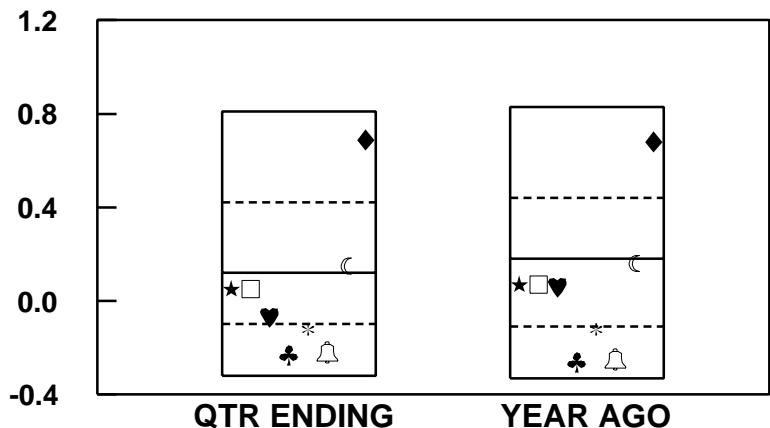

GROWTH EXPOSURE

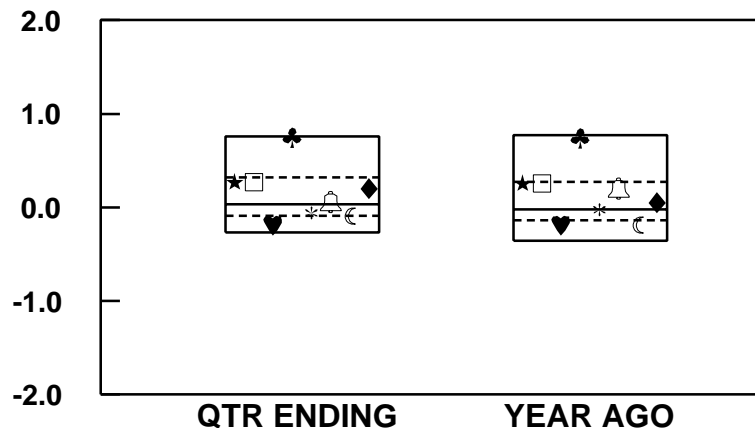

EFFECTS ON RETURN

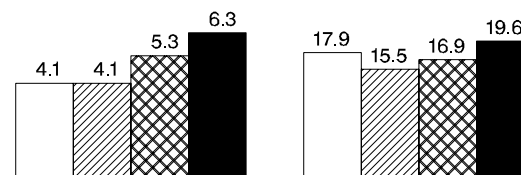
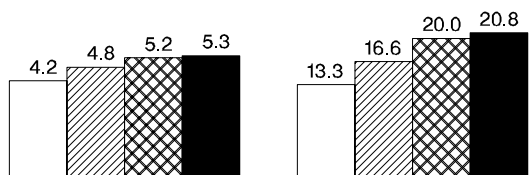
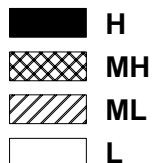

★ MUNI COMPOSITE	0.05	56	0.07	59	0.27	28	0.26	26
□ EQTY COMPOSITE	0.05	56	0.07	59	0.27	28	0.26	26
♥ DELAWARE	-0.07	70	0.06	60	-0.19	87	-0.19	80
♣ ALLIANCE	-0.23	89	-0.26	91	0.75	5	0.74	5
* S&P 500	-0.12	77	-0.12	75	-0.06	69	-0.02	57
🔔 R 1000(R) GR	-0.22	88	-0.25	91	0.06	47	0.20	30
☾ R 1000(R) VALUE	0.15	47	0.16	51	-0.09	74	-0.19	79
◆ R 2000(R)	0.69	9	0.68	11	0.20	33	0.05	41
MEDIAN	0.12		0.18		0.03		-0.02	

VERMONT MUNICIPAL EMPLOYEES

DOMESTIC EQUITY ONLY PORTFOLIO CHARACTERISTICS

PERIODS ENDING 9/05

FINANCIAL LEVERAGE

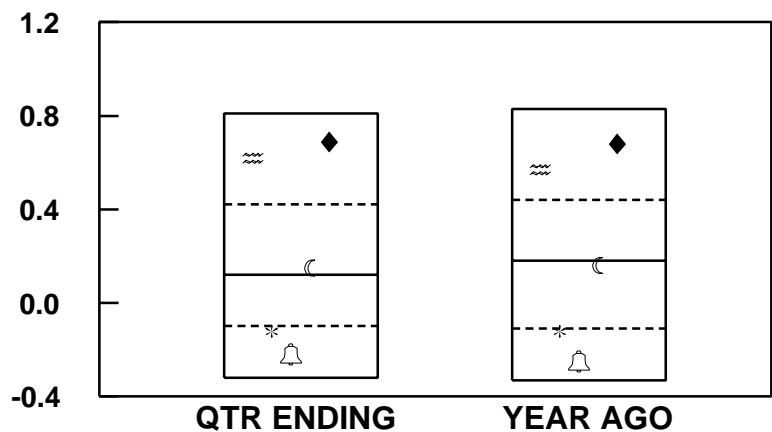

GROWTH EXPOSURE

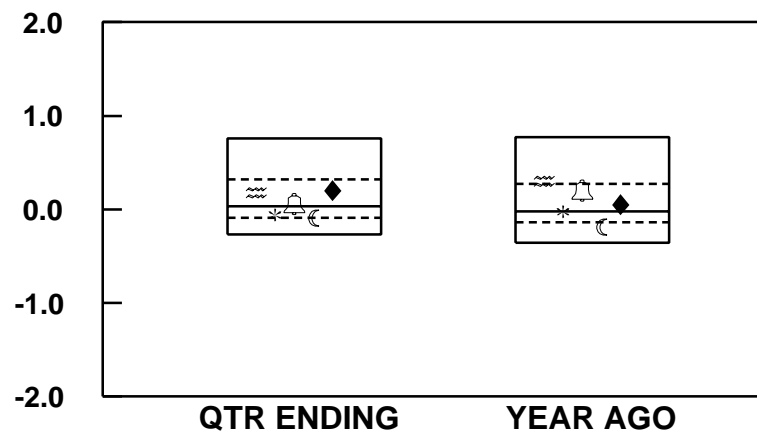

EFFECTS ON RETURN

- H
- MH
- ML
- L

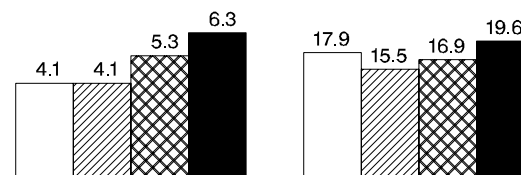
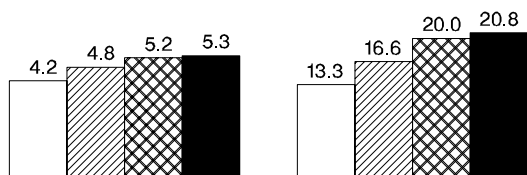

	QTR ENDING	YEAR AGO	QTR ENDING	YEAR AGO
≈ LAZARD	0.62	11	0.57	16
* S&P 500	-0.12	77	-0.12	75
🔔 R 1000(R) GR	-0.22	88	-0.25	91
☾ R 1000(R) VALUE	0.15	47	0.16	51
◆ R 2000(R)	0.69	9	0.68	11
MEDIAN	0.12	0.18	0.03	-0.02

VERMONT MUNICIPAL EMPLOYEES

DIVERSIFICATION BY INDUPLY SECTOR

QUARTER ENDING 9/05

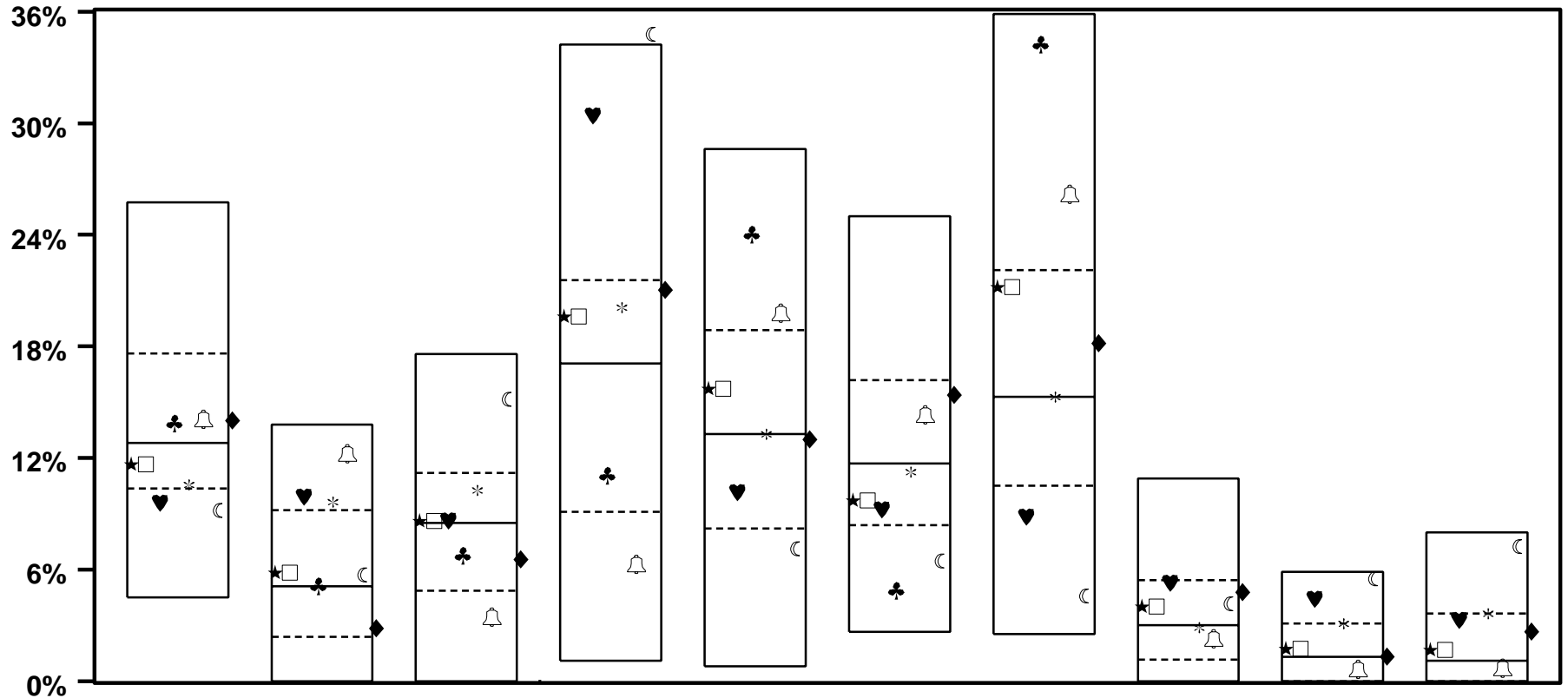

	CONSUMER DISCR		CONSUMER STAPLES		EN-ERGY		FINAN-CIALS		HEALTH CARE		INDUST-RIALS		INFO TECH		MATER-IALS		TELECOM SERVICES		UTIL-ITIES	
★ MUNI COMPOSITE	11.7	58	5.9	44	8.6	49	19.6	38	15.7	36	9.7	68	21.2	27	4.0	37	1.8	43	1.7	45
□ EQTY COMPOSITE	11.7	58	5.9	44	8.6	49	19.6	38	15.7	36	9.7	68	21.2	27	4.0	37	1.8	43	1.7	45
♥ DELAWARE	9.6	79	9.9	14	8.6	49	30.4	9	10.2	68	9.3	71	8.9	79	5.3	25	4.5	11	3.3	32
♣ ALLIANCE	13.9	44	5.1	49	6.8	62	11.1	68	24.0	11	4.9	90	34.2	6						
* S&P 500	10.6	71	9.6	21	10.3	33	20.1	32	13.3	50	11.2	55	15.3	51	2.9	53	3.1	22	3.6	25
🔔 R 1000(R) GR	14.1	42	12.2	6	3.5	80	6.3	84	19.8	22	14.3	34	26.2	16	2.3	62	0.6	57	0.7	52
☾ R 1000(R) VALUE	9.2	82	5.7	45	15.2	11	34.8	3	7.1	79	6.5	85	4.6	91	4.2	36	5.5	6	7.3	6
◆ R 2000(R)	14.0	43	2.9	68	6.5	63	21.1	26	13.0	56	15.4	28	18.2	35	4.8	28	1.3	49	2.7	37
MEDIAN	12.8		5.1		8.5		17.1		13.3		11.7		15.3		3.0		1.3		1.1	

VERMONT MUNICIPAL EMPLOYEES

DIVERSIFICATION BY INDUSTRY SECTOR

QUARTER ENDING 9/05

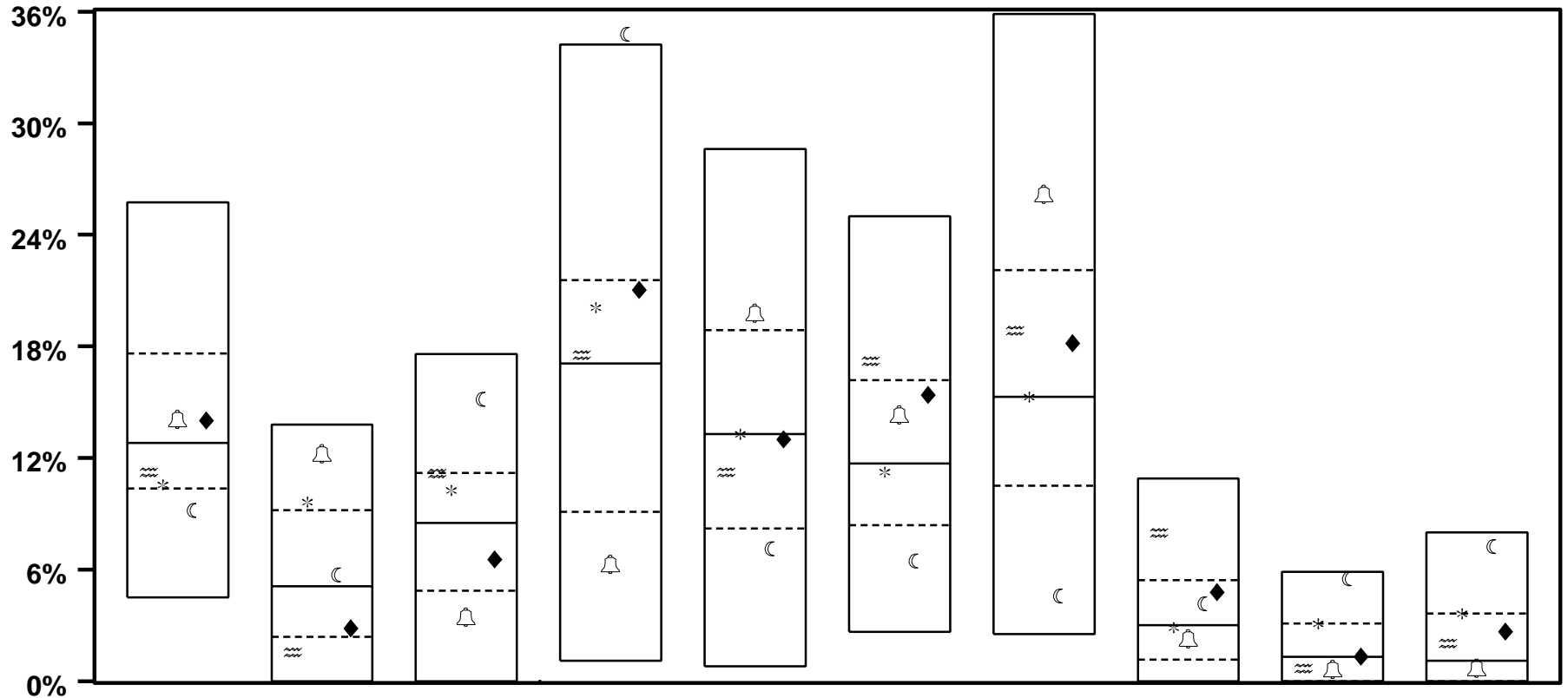

	CONSUMER DISCR		CONSUMER STAPLES		EN-ERGY		FINAN-CIALS		HEALTH CARE		INDUST-RIALS		INFO TECH		MATER-IALS		TELECOM SERVICES		UTIL-ITIES	
⋈ LAZARD	11.2	62	1.6	81	11.2	25	17.6	47	11.2	63	17.2	20	18.9	33	8.0	13	0.7	56	2.0	41
* S&P 500	10.6	71	9.6	21	10.3	33	20.1	32	13.3	50	11.2	55	15.3	51	2.9	53	3.1	22	3.6	25
🔔 R 1000(R) GR	14.1	42	12.2	6	3.5	80	6.3	84	19.8	22	14.3	34	26.2	16	2.3	62	0.6	57	0.7	52
☾ R 1000(R) VALUE	9.2	82	5.7	45	15.2	11	34.8	3	7.1	79	6.5	85	4.6	91	4.2	36	5.5	6	7.3	6
◆ R 2000(R)	14.0	43	2.9	68	6.5	63	21.1	26	13.0	56	15.4	28	18.2	35	4.8	28	1.3	49	2.7	37
MEDIAN	12.8		5.1		8.5		17.1		13.3		11.7		15.3		3.0		1.3		1.1	

VERMONT MUNICIPAL EMPLOYEES

RATES OF RETURN BY INDUSTRY SECTOR

QUARTER ENDING 9/05

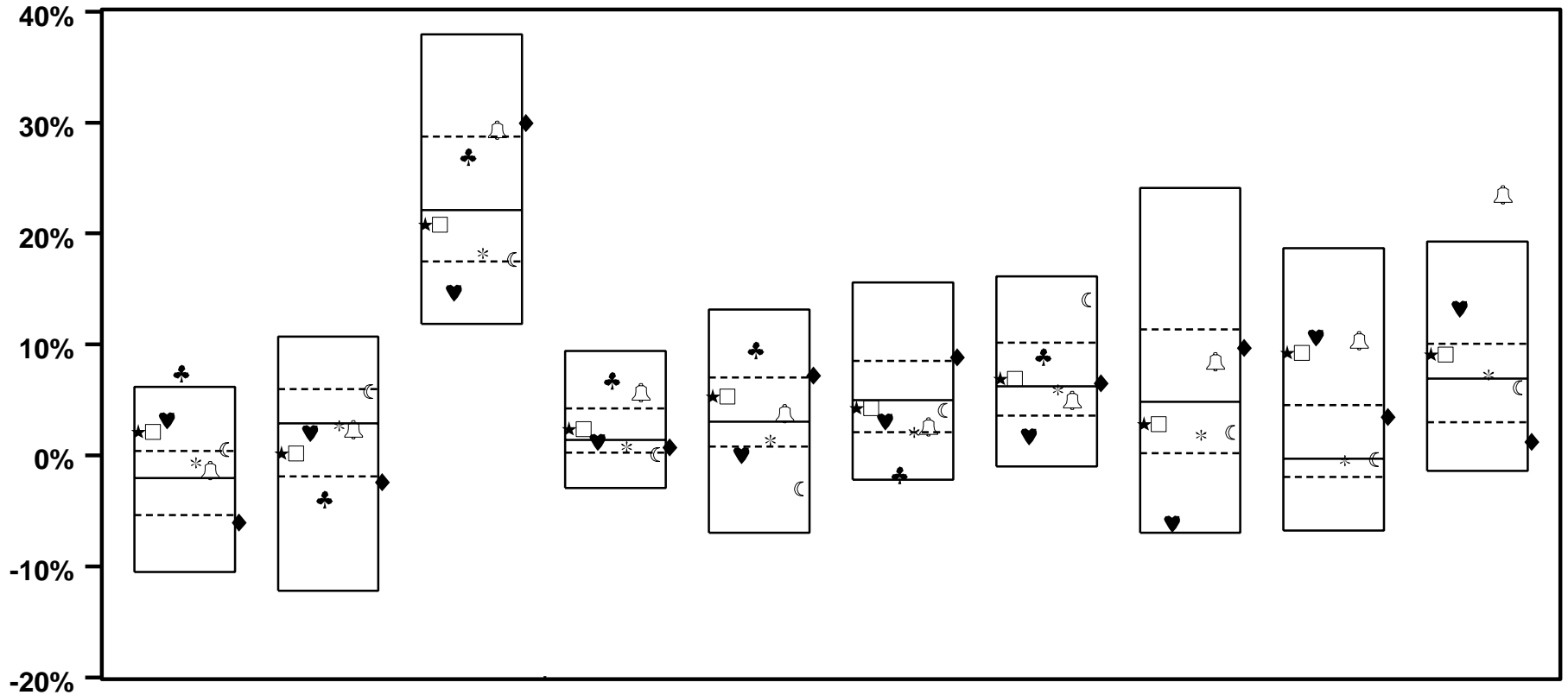

	CONSUMER DISCR		CONSUMER STAPLES		EN-ERGY		FINAN-CIALS		HEALTH CARE		INDUST-RIALS		INFO TECH		MATER-IALS		TELECOM SERVICES		UTIL-ITIES	
★ MUNI COMPOSITE	2.1	15	0.2	66	20.8	55	2.4	41	5.3	35	4.3	55	6.9	44	2.8	58	9.3	12	9.1	28
□ EQTY COMPOSITE	2.1	15	0.2	66	20.8	55	2.4	41	5.3	35	4.3	55	6.9	44	2.8	58	9.3	12	9.1	28
♥ DELAWARE	3.2	9	2.0	55	14.7	86	1.3	52	0.0	78	3.1	64	1.7	85	-6.1	92	10.7	11	13.2	17
♣ ALLIANCE	7.4	2	-3.9	81	26.9	31	6.8	13	9.5	12	-1.8	92	8.9	31						
* S&P 500	-0.7	39	2.7	52	18.2	70	0.8	59	1.4	64	2.1	73	5.9	52	1.9	69	-0.5	62	7.3	43
🔔 R 1000(R) GR	-1.4	43	2.3	54	29.3	23	5.7	16	3.8	44	2.6	67	5.0	63	8.5	35	10.4	11	23.5	1
🌙 R 1000(R) VALUE	0.6	23	5.8	25	17.7	74	0.1	76	-3.0	87	4.1	56	14.1	9	2.1	61	-0.4	51	6.1	54
◆ R 2000(R)	-6.0	79	-2.4	77	30.0	21	0.7	62	7.2	23	8.9	23	6.5	47	9.7	31	3.5	27	1.2	83
MEDIAN	-2.1		2.9		22.1		1.4		3.1		5.0		6.2		4.8		-0.3		6.9	

VERMONT MUNICIPAL EMPLOYEES

RATES OF RETURN BY INDUSTRY SECTOR

QUARTER ENDING 9/05

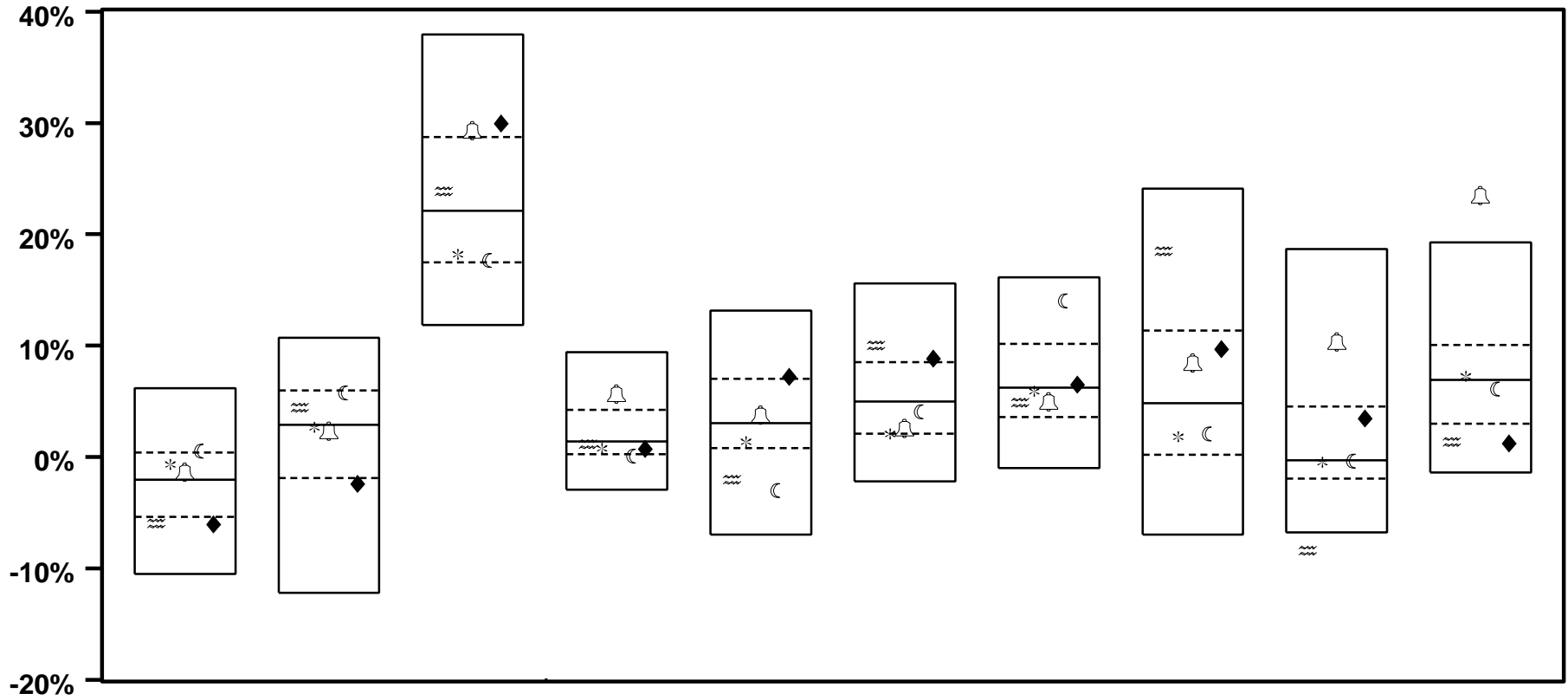

	CONSUMER DISCR		CONSUMER STAPLES		EN-ERGY		FINAN-CIALS		HEALTH CARE		INDUST-RIALS		INFO TECH		MATER-IALS		TELECOM SERVICES		UTIL-ITIES	
≈ LAZARD	-5.9	78	4.5	34	23.9	43	1.2	54	-2.0	84	10.0	17	4.9	64	18.5	13	-8.4	96	1.4	82
* S&P 500	-0.7	39	2.7	52	18.2	70	0.8	59	1.4	64	2.1	73	5.9	52	1.9	69	-0.5	62	7.3	43
🔔 R 1000(R) GR	-1.4	43	2.3	54	29.3	23	5.7	16	3.8	44	2.6	67	5.0	63	8.5	35	10.4	11	23.5	1
Ⓒ R 1000(R) VALUE	0.6	23	5.8	25	17.7	74	0.1	76	-3.0	87	4.1	56	14.1	9	2.1	61	-0.4	51	6.1	54
◆ R 2000(R)	-6.0	79	-2.4	77	30.0	21	0.7	62	7.2	23	8.9	23	6.5	47	9.7	31	3.5	27	1.2	83
MEDIAN	-2.1		2.9		22.1		1.4		3.1		5.0		6.2		4.8		-0.3		6.9	

VERMONT MUNICIPAL EMPLOYEES

RATES OF RETURN BY INDUSTRY SECTOR

YEAR ENDING 9/05

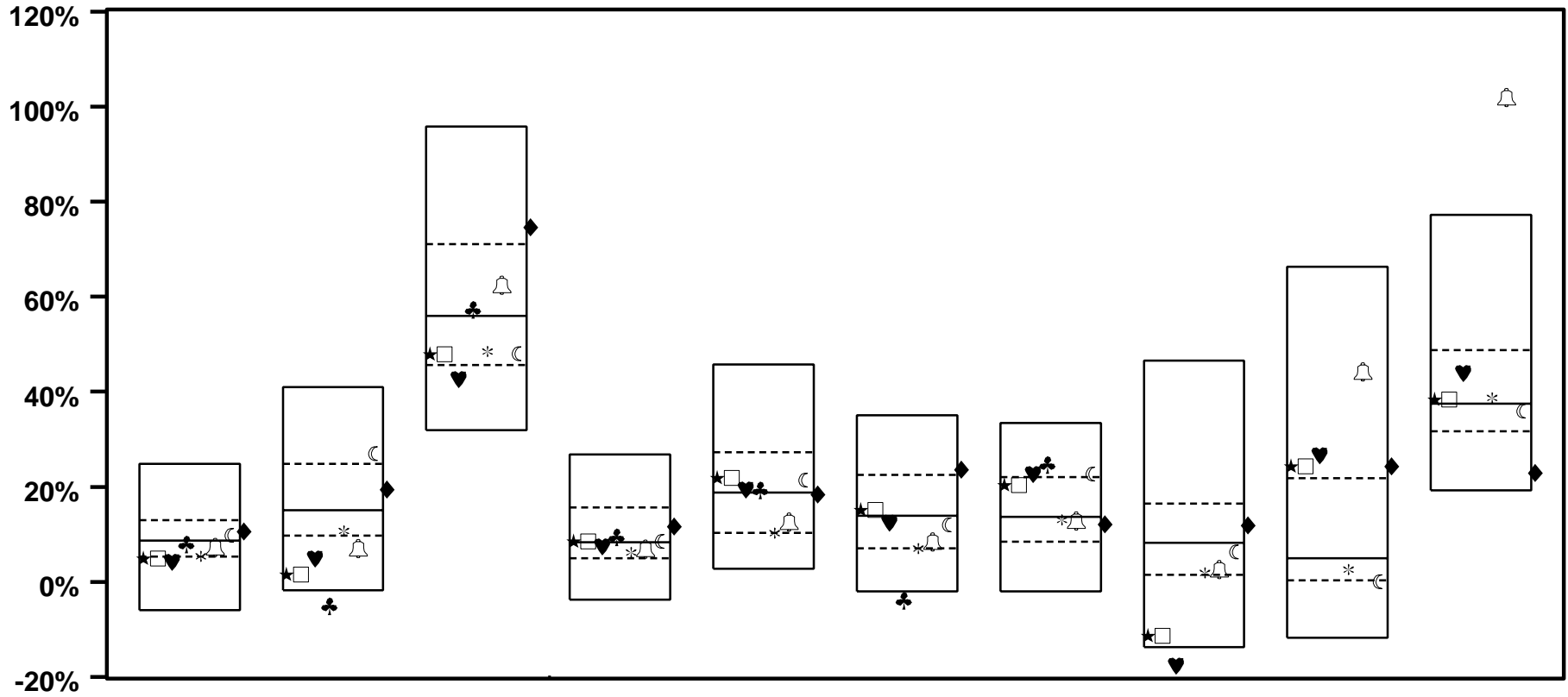

	CONSUMER DISCR		CONSUMER STAPLES		EN-ERGY		FINAN-CIALS		HEALTH CARE		INDUST-RIALS		INFO TECH		MATER-IALS		TELECOM SERVICES		UTIL-ITIES	
★ MUNI COMPOSITE	5.0	75	1.6	90	48.0	71	8.6	48	21.9	41	15.2	43	20.4	29	-11.3	94	24.4	24	38.4	48
□ EQTY COMPOSITE	5.0	75	1.6	90	48.0	71	8.6	48	21.9	41	15.2	43	20.4	29	-11.3	94	24.4	24	38.4	48
♥ DELAWARE	4.2	78	5.0	85	42.7	81	7.5	55	19.5	48	12.5	54	22.7	23	-17.6	96	26.7	22	43.9	30
♣ ALLIANCE	7.9	54	-5.0	96	57.4	48	9.4	44	19.3	48	-3.9	97	24.6	18						
* S&P 500	5.4	74	10.7	71	48.5	66	6.3	62	10.3	75	7.1	78	13.1	57	2.0	70	2.6	59	38.7	37
🔔 R 1000(R) GR	7.2	59	7.0	79	62.5	38	6.9	58	12.6	69	8.4	67	12.8	59	2.6	66	44.2	13	101.9	1
🌙 R 1000(R) VALUE	9.9	41	26.9	20	48.0	71	8.5	48	21.4	41	12.0	56	22.7	23	6.3	55	0.0	75	35.9	56
◆ R 2000(R)	10.7	37	19.5	37	74.7	19	11.7	37	18.4	51	23.7	22	12.1	63	12.0	36	24.4	24	23.0	91
MEDIAN	8.6		15.1		56.0		8.3		18.8		13.9		13.6		8.2		5.0		37.5	

VERMONT MUNICIPAL EMPLOYEES

RATES OF RETURN BY INDUSTRY SECTOR

YEAR ENDING 9/05

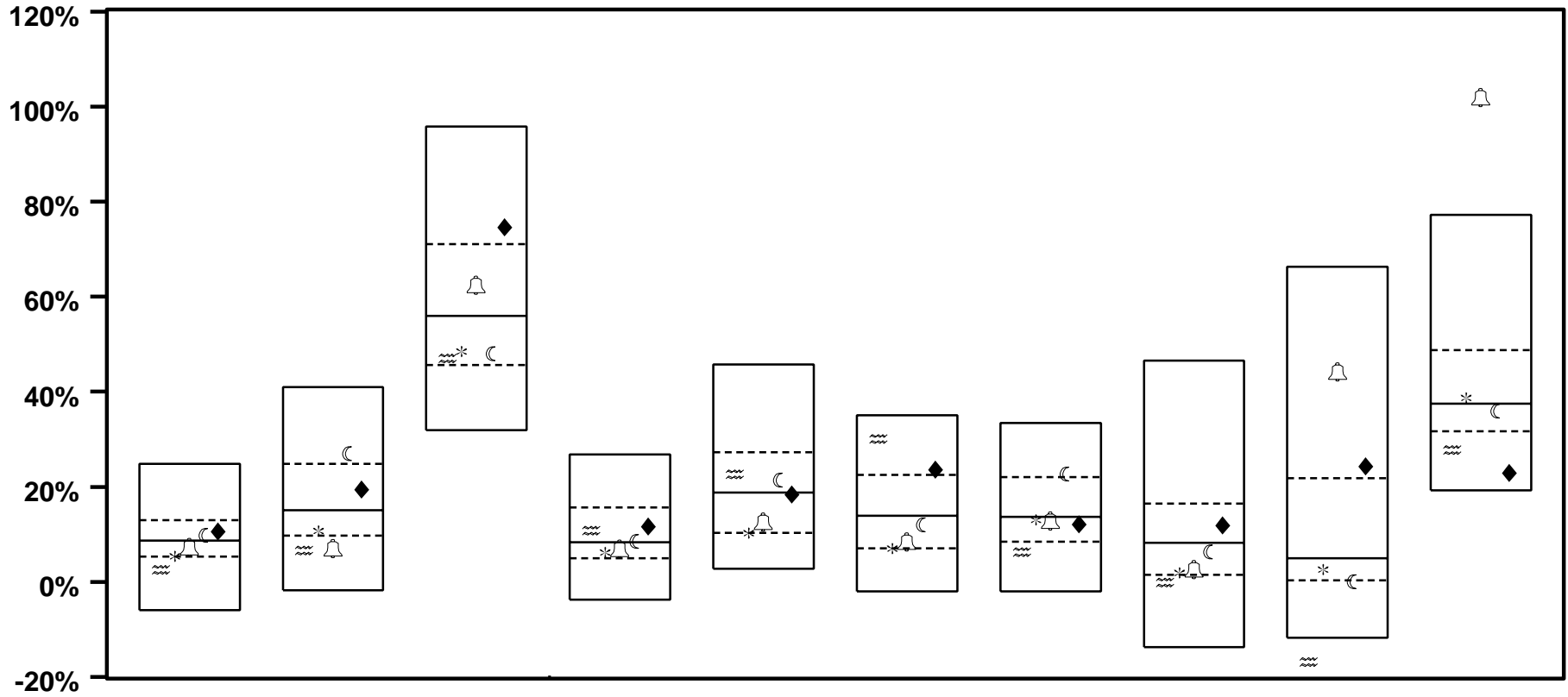

	CONSUMER DISCR		CONSUMER STAPLES		EN-ERGY		FINAN-CIALS		HEALTH CARE		INDUST-RIALS		INFO TECH		MATER-IALS		TELECOM SERVICES		UTIL-ITIES	
⋈ LAZARD	2.6	83	6.7	80	47.1	73	10.8	40	22.6	39	30.2	10	6.3	82	-0.1	79	-16.8	97	27.8	84
* S&P 500	5.4	74	10.7	71	48.5	66	6.3	62	10.3	75	7.1	78	13.1	57	2.0	70	2.6	59	38.7	37
🔔 R 1000(R) GR	7.2	59	7.0	79	62.5	38	6.9	58	12.6	69	8.4	67	12.8	59	2.6	66	44.2	13	101.9	1
☾ R 1000(R) VALUE	9.9	41	26.9	20	48.0	71	8.5	48	21.4	41	12.0	56	22.7	23	6.3	55	0.0	75	35.9	56
◆ R 2000(R)	10.7	37	19.5	37	74.7	19	11.7	37	18.4	51	23.7	22	12.1	63	12.0	36	24.4	24	23.0	91
MEDIAN	8.6		15.1		56.0		8.3		18.8		13.9		13.6		8.2		5.0		37.5	

VERMONT MUNICIPAL EMPLOYEES
EQUITY PERFORMANCE ATTRIBUTION
QUARTER ENDING 9/05

MUNICIPAL SYSTEM COMPOSITE

	PORTFOLIO		S&P 500		SELECTION		
	PCT OF BEGIN MKT VAL A	RATE OF RETURN B	PCT OF BEGIN MKT VAL C	RATE OF RETURN D	STOCK E	SECTOR F	TOTAL G
CONS DISCRETIONARY	11.7	2.1	11.5	-0.7	0.3	0.0	0.3
CONSUMER STAPLES	6.5	0.2	10.5	2.7	-0.2	0.0	-0.1
ENERGY	7.7	20.8	8.6	18.2	0.2	-0.1	0.1
FINANCIALS	20.8	2.4	20.2	0.8	0.3	0.0	0.3
HEALTH CARE	14.7	5.3	13.2	1.4	0.6	0.0	0.5
INDUSTRIALS	10.1	4.3	11.3	2.1	0.2	0.0	0.2
INFO TECHNOLOGY	20.1	6.9	15.2	5.9	0.2	0.1	0.3
MATERIALS	3.8	2.8	2.9	1.9	0.0	0.0	0.0
TELECOM SERVICES	1.9	9.3	3.1	-0.5	0.2	0.0	0.2
UTILITIES	1.8	9.1	3.4	7.3	0.0	-0.1	0.0
MISCELLANEOUS	0.9	14.0	0.0		0.1	0.0	0.1
	100.0%	5.4	100.0%	3.5	2.0	-0.1	1.9

EQUITY ONLY BUY&HOLD RETURN (B)	5.4	STOCK SELECTION (E)	2.0
BENCHMARK BUY&HOLD RETURN (D)	3.5	SECTOR WEIGHTING (F)	-0.1
TOTAL RELATIVE RETURN DIFFERENCE (B/D)	1.9	TOTAL SELECTION (E * F)	1.9
EQUITY ONLY ACTUAL RETURN (*)	5.4		
EQUITY ONLY BUY&HOLD RETURN (B)	5.4		
INTRA-PERIOD TRADING (* / B)	-0.1		
TOTAL ACTIVE MANAGEMENT VALUE ADDED (SELECTION * TRADING)	1.9		

VERMONT MUNICIPAL EMPLOYEES
EQUITY PERFORMANCE ATTRIBUTION
QUARTER ENDING 9/05

DOMESTIC EQUITY COMPOSITE

	PORTFOLIO		S&P 500		SELECTION		
	PCT OF BEGIN MKT VAL A	RATE OF RETURN B	PCT OF BEGIN MKT VAL C	RATE OF RETURN D	STOCK E	SECTOR F	TOTAL G
CONS DISCRETIONARY	11.7	2.1	11.5	-0.7	0.3	0.0	0.3
CONSUMER STAPLES	6.5	0.2	10.5	2.7	-0.2	0.0	-0.1
ENERGY	7.7	20.8	8.6	18.2	0.2	-0.1	0.1
FINANCIALS	20.8	2.4	20.2	0.8	0.3	0.0	0.3
HEALTH CARE	14.7	5.3	13.2	1.4	0.6	0.0	0.5
INDUSTRIALS	10.1	4.3	11.3	2.1	0.2	0.0	0.2
INFO TECHNOLOGY	20.1	6.9	15.2	5.9	0.2	0.1	0.3
MATERIALS	3.8	2.8	2.9	1.9	0.0	0.0	0.0
TELECOM SERVICES	1.9	9.3	3.1	-0.5	0.2	0.0	0.2
UTILITIES	1.8	9.1	3.4	7.3	0.0	-0.1	0.0
MISCELLANEOUS	0.9	14.0	0.0		0.1	0.0	0.1
	100.0%	5.4	100.0%	3.5	2.0	-0.1	1.9

EQUITY ONLY BUY&HOLD RETURN (B)	5.4	STOCK SELECTION (E)	2.0
BENCHMARK BUY&HOLD RETURN (D)	3.5	SECTOR WEIGHTING (F)	-0.1
TOTAL RELATIVE RETURN DIFFERENCE (B/D)	1.9	TOTAL SELECTION (E * F)	1.9
EQUITY ONLY ACTUAL RETURN (*)	5.4		
EQUITY ONLY BUY&HOLD RETURN (B)	5.4		
INTRA-PERIOD TRADING (* / B)	-0.1		
TOTAL ACTIVE MANAGEMENT VALUE ADDED (SELECTION * TRADING)	1.9		

VERMONT MUNICIPAL EMPLOYEES
EQUITY PERFORMANCE ATTRIBUTION
QUARTER ENDING 9/05

DELAWARE

PORTFOLIO	R 1000(R) VALUE		SELECTION				
	PCT OF BEGIN MKT VAL A	RATE OF RETURN B	PCT OF BEGIN MKT VAL C	RATE OF RETURN D	STOCK E	SECTOR F	TOTAL G
CONS DISCRETIONARY	7.3	3.2	9.6	0.6	0.2	0.1	0.3
CONSUMER STAPLES	10.0	2.0	5.6	5.8	-0.4	0.1	-0.3
ENERGY	8.3	14.7	13.4	17.7	-0.2	-0.7	-0.9
FINANCIALS	30.3	1.3	36.0	0.1	0.4	0.2	0.6
HEALTH CARE	11.2	0.0	7.6	-3.0	0.3	-0.2	0.1
INDUSTRIALS	9.5	3.1	6.4	4.1	-0.1	0.0	-0.1
INFO TECHNOLOGY	7.4	1.7	4.2	14.1	-0.9	0.3	-0.6
MATERIALS	6.3	-6.1	4.2	2.1	-0.5	0.0	-0.6
TELECOM SERVICES	4.5	10.7	5.8	-0.4	0.5	0.1	0.6
UTILITIES	3.1	13.2	7.1	6.1	0.2	-0.1	0.1
MISCELLANEOUS	2.1		0.0		0.0	-0.1	-0.1
	100.0%	3.0	100.0%	3.9	-0.5	-0.4	-0.9

EQUITY ONLY BUY&HOLD RETURN (B)	3.0	STOCK SELECTION (E)	-0.5
BENCHMARK BUY&HOLD RETURN (D)	3.9	SECTOR WEIGHTING (F)	-0.4
TOTAL RELATIVE RETURN DIFFERENCE (B/D)	-0.9	TOTAL SELECTION (E * F)	-0.9
EQUITY ONLY ACTUAL RETURN (*)	2.7		
EQUITY ONLY BUY&HOLD RETURN (B)	3.0		
INTRA-PERIOD TRADING (* / B)	-0.3		
TOTAL ACTIVE MANAGEMENT VALUE ADDED (SELECTION * TRADING)	-1.2		

VERMONT MUNICIPAL EMPLOYEES
EQUITY PERFORMANCE ATTRIBUTION
QUARTER ENDING 9/05

ALLIANCE LARGE CAP GROWTH FUND

	PORTFOLIO		R 1000(R) GR		SELECTION		
	PCT OF BEGIN MKT VAL A	RATE OF RETURN B	PCT OF BEGIN MKT VAL C	RATE OF RETURN D	STOCK E	SECTOR F	TOTAL G
CONS DISCRETIONARY	13.8	7.4	14.9	-1.4	1.2	0.1	1.3
CONSUMER STAPLES	5.9	-3.9	12.4	2.3	-0.4	0.1	-0.3
ENERGY	5.2	26.9	2.8	29.3	-0.1	0.6	0.4
FINANCIALS	11.5	6.8	6.2	5.7	0.1	0.1	0.2
HEALTH CARE	23.0	9.5	19.8	3.8	1.3	0.0	1.3
INDUSTRIALS	7.4	-1.8	14.5	2.6	-0.3	0.1	-0.2
INFO TECHNOLOGY	33.3	8.9	26.0	5.0	1.3	0.1	1.3
MATERIALS	0.0		2.2	8.5	0.0	-0.1	-0.1
TELECOM SERVICES	0.0		0.6	10.4	0.0	0.0	0.0
UTILITIES	0.0		0.6	23.5	0.0	-0.1	-0.1
MISCELLANEOUS	0.0		0.0	-2.3			
	100.0%	8.0	100.0%	4.1	3.0	0.7	3.8

EQUITY ONLY BUY&HOLD RETURN (B)	8.0	STOCK SELECTION (E)	3.0
BENCHMARK BUY&HOLD RETURN (D)	4.1	SECTOR WEIGHTING (F)	0.7
TOTAL RELATIVE RETURN DIFFERENCE (B/D)	3.8	TOTAL SELECTION (E * F)	3.8
EQUITY ONLY ACTUAL RETURN (*)	8.6		
EQUITY ONLY BUY&HOLD RETURN (B)	8.0		
INTRA-PERIOD TRADING (* / B)	0.6		
TOTAL ACTIVE MANAGEMENT VALUE ADDED (SELECTION * TRADING)	4.4		

VERMONT MUNICIPAL EMPLOYEES
EQUITY PERFORMANCE ATTRIBUTION
QUARTER ENDING 9/05

LAZARD SMALL CAP FUND

	PORTFOLIO		R 2000(R)		SELECTION		
	PCT OF BEGIN MKT VAL A	RATE OF RETURN B	PCT OF BEGIN MKT VAL C	RATE OF RETURN D	STOCK E	SECTOR F	TOTAL G
CONS DISCRETIONARY	15.5	-5.9	15.5	-6.0	0.0	0.0	0.0
CONSUMER STAPLES	1.9	4.5	3.1	-2.4	0.1	0.1	0.2
ENERGY	10.7	23.9	5.2	30.0	-0.6	1.3	0.7
FINANCIALS	20.1	1.2	22.0	0.7	0.1	0.1	0.2
HEALTH CARE	7.4	-2.0	12.7	7.2	-0.7	-0.1	-0.8
INDUSTRIALS	15.3	10.0	14.9	8.9	0.2	0.0	0.2
INFO TECHNOLOGY	19.8	4.9	17.8	6.5	-0.3	0.0	-0.3
MATERIALS	5.7	18.5	4.7	9.7	0.5	0.0	0.6
TELECOM SERVICES	0.6	-8.4	1.3	3.5	-0.1	0.0	-0.1
UTILITIES	2.6	1.4	2.7	1.2	0.0	0.0	0.0
MISCELLANEOUS	0.5	14.0	0.1	31.0	-0.1	0.1	0.0
	100.0%	5.4	100.0%	4.7	-0.8	1.6	0.7

EQUITY ONLY BUY&HOLD RETURN (B)	5.4	STOCK SELECTION (E)	-0.8
BENCHMARK BUY&HOLD RETURN (D)	4.7	SECTOR WEIGHTING (F)	1.6
TOTAL RELATIVE RETURN DIFFERENCE (B/D)	0.7	TOTAL SELECTION (E * F)	0.7
EQUITY ONLY ACTUAL RETURN (*)	4.9		
EQUITY ONLY BUY&HOLD RETURN (B)	5.4		
INTRA-PERIOD TRADING (* / B)	-0.5		
TOTAL ACTIVE MANAGEMENT VALUE ADDED (SELECTION * TRADING)	0.2		

VERMONT MUNICIPAL EMPLOYEES
HISTORICAL EQUITY ATTRIBUTION
PERIODS ENDING 9/05

MUNICIPAL SYSTEM COMPOSITE

	EQUITY ONLY BUY&HOLD RETURN	BENCHMARK RETURN	STOCK	SECTOR	TOTAL	SELECTION IMPACT	INTRA MONTH TRADING	TOTAL VALUE ADDED
LAST QTR	5.4	3.5	1.9	-0.1	1.8	1.8	-0.1	1.8
LAST 2 QTRS	8.7	5.0	3.7	-0.1	3.6	3.6	0.2	3.8
LAST 3 QTRS	5.2	2.7	3.2	-0.8	2.4	2.4	0.1	2.6
LAST YEAR	14.9	12.1	3.0	-0.6	2.5	2.5	0.6	3.1
LAST 2 YEARS	13.3	13.0	1.0	-0.7	0.3	0.3	0.8	1.1
LAST 3 YEARS	16.3	16.7	0.3	-0.6	-0.3	-0.3	0.6	0.3
LAST 4 YEARS	7.2	6.1	1.1	0.0	1.1	1.1	1.0	2.1
LAST 5 YEARS								
YEAR ENDING 12/04	9.5	10.8	-0.6	-0.6	-1.2	-1.2	1.2	0.0
YEAR ENDING 12/03	30.3	28.6	0.7	0.6	1.3	1.3	0.3	1.6

BENCHMARK: S&P 500

VERMONT MUNICIPAL EMPLOYEES
HISTORICAL EQUITY ATTRIBUTION
PERIODS ENDING 9/05

DOMESTIC EQUITY COMPOSITE

	EQUITY ONLY BUY&HOLD RETURN	BENCHMARK RETURN	STOCK	SECTOR	TOTAL	SELECTION IMPACT	INTRA MONTH TRADING	TOTAL VALUE ADDED
LAST QTR	5.4	3.5	1.9	-0.1	1.8	1.8	-0.1	1.8
LAST 2 QTRS	8.7	5.0	3.7	-0.1	3.6	3.6	0.2	3.8
LAST 3 QTRS	5.2	2.7	3.2	-0.8	2.4	2.4	0.1	2.6
LAST YEAR	14.9	12.1	3.0	-0.6	2.5	2.5	0.6	3.1
LAST 2 YEARS	13.3	13.0	1.0	-0.7	0.3	0.3	0.8	1.1
LAST 3 YEARS	16.3	16.7	0.3	-0.6	-0.3	-0.3	0.6	0.3
LAST 4 YEARS	7.2	6.1	1.1	0.0	1.1	1.1	1.0	2.1
LAST 5 YEARS								
YEAR ENDING 12/04	9.5	10.8	-0.6	-0.6	-1.2	-1.2	1.2	0.0
YEAR ENDING 12/03	30.3	28.6	0.7	0.6	1.3	1.3	0.3	1.6

BENCHMARK: S&P 500

VERMONT MUNICIPAL EMPLOYEES
HISTORICAL EQUITY ATTRIBUTION
PERIODS ENDING 9/05

DELAWARE

	EQUITY ONLY BUY&HOLD RETURN	BENCHMARK RETURN	STOCK	SECTOR	TOTAL	SELECTION IMPACT	INTRA MONTH TRADING	TOTAL VALUE ADDED
LAST QTR	3.0	3.9	-0.5	-0.4	-0.9	-0.9	-0.3	-1.2
LAST 2 QTRS	4.6	5.7	-0.7	-0.4	-1.0	-1.0	-0.6	-1.6
LAST 3 QTRS	3.9	5.8	-1.0	-0.7	-1.7	-1.7	-1.2	-2.9
LAST YEAR	12.8	16.7	-3.4	0.1	-3.3	-3.3	-1.0	-4.3
LAST 2 YEARS	14.1	18.5	-2.9	-0.8	-3.7	-3.7	-0.4	-4.1
LAST 3 YEARS	17.2	20.7	-1.6	-1.3	-2.9	-2.9	-0.2	-3.1
LAST 4 YEARS	8.7	8.2	0.0	0.4	0.4	0.4	-0.3	0.2
LAST 5 YEARS								
YEAR ENDING 12/04	11.0	16.4	-4.0	-0.6	-4.6	-4.6	0.4	-4.2
YEAR ENDING 12/03	29.9	30.0	0.2	-0.3	-0.1	-0.1	-0.3	-0.4

BENCHMARK: R 1000(R) VALUE

VERMONT MUNICIPAL EMPLOYEES
HISTORICAL EQUITY ATTRIBUTION
PERIODS ENDING 9/05

ALLIANCE LARGE CAP GROWTH FUND

	EQUITY ONLY BUY&HOLD RETURN	BENCHMARK RETURN	STOCK	SECTOR	TOTAL	SELECTION IMPACT	INTRA MONTH TRADING	TOTAL VALUE ADDED
LAST QTR	8.0	4.1	3.0	0.7	3.8	3.8	0.6	4.4
LAST 2 QTRS	14.6	6.6	6.1	1.3	7.5	7.5	0.9	8.5
LAST 3 QTRS	6.6	2.2	4.1	0.2	4.3	4.3	1.7	6.1
LAST YEAR	16.1	11.5	3.5	0.6	4.1	4.1	2.0	6.2
LAST 2 YEARS	10.4	9.5	1.4	-0.6	0.8	0.8	1.5	2.3
LAST 3 YEARS	12.9	14.8	-0.8	-0.8	-1.6	-1.6	1.2	-0.4
LAST 4 YEARS	2.1	4.0	-1.3	-0.6	-1.9	-1.9	2.1	0.2
LAST 5 YEARS								
YEAR ENDING 12/04	5.0	6.4	-0.1	-1.3	-1.3	-1.3	1.5	0.1
YEAR ENDING 12/03	26.1	29.7	-2.4	-0.4	-2.8	-2.8	0.0	-2.8

BENCHMARK: R 1000(R) GR

VERMONT MUNICIPAL EMPLOYEES
HISTORICAL EQUITY ATTRIBUTION
PERIODS ENDING 9/05

LAZARD SMALL CAP FUND

	EQUITY ONLY BUY&HOLD RETURN	BENCHMARK RETURN	STOCK	SECTOR	TOTAL	SELECTION IMPACT	INTRA MONTH TRADING	TOTAL VALUE ADDED
LAST QTR	5.4	4.7	-0.8	1.6	0.7	0.7	-0.5	0.2
LAST 2 QTRS	6.6	9.3	-3.8	1.5	-2.4	-2.4	0.3	-2.1
LAST 3 QTRS	5.1	3.5	-0.7	2.3	1.6	1.6	-0.1	1.5
LAST YEAR	16.2	18.0	-3.7	2.2	-1.6	-1.6	1.2	-0.4
LAST 2 YEARS	16.6	18.5	-3.6	2.0	-1.7	-1.7	1.5	-0.2
LAST 3 YEARS	20.3	24.2	-3.6	0.5	-3.2	-3.2	1.0	-2.2
LAST 4 YEARS	12.6	14.9	-1.7	-0.3	-2.0	-2.0	1.4	-0.6
LAST 5 YEARS								
YEAR ENDING 12/04	14.1	18.7	-4.8	1.0	-3.9	-3.9	1.8	-2.2
YEAR ENDING 12/03	39.4	47.0	-4.2	-1.0	-5.2	-5.2	0.4	-4.8

BENCHMARK: R 2000(R)

VERMONT MUNICIPAL EMPLOYEES

EQUITY ONLY - RATES OF RETURN

COMPARED TO FUNDS WITH SIMILAR BETA

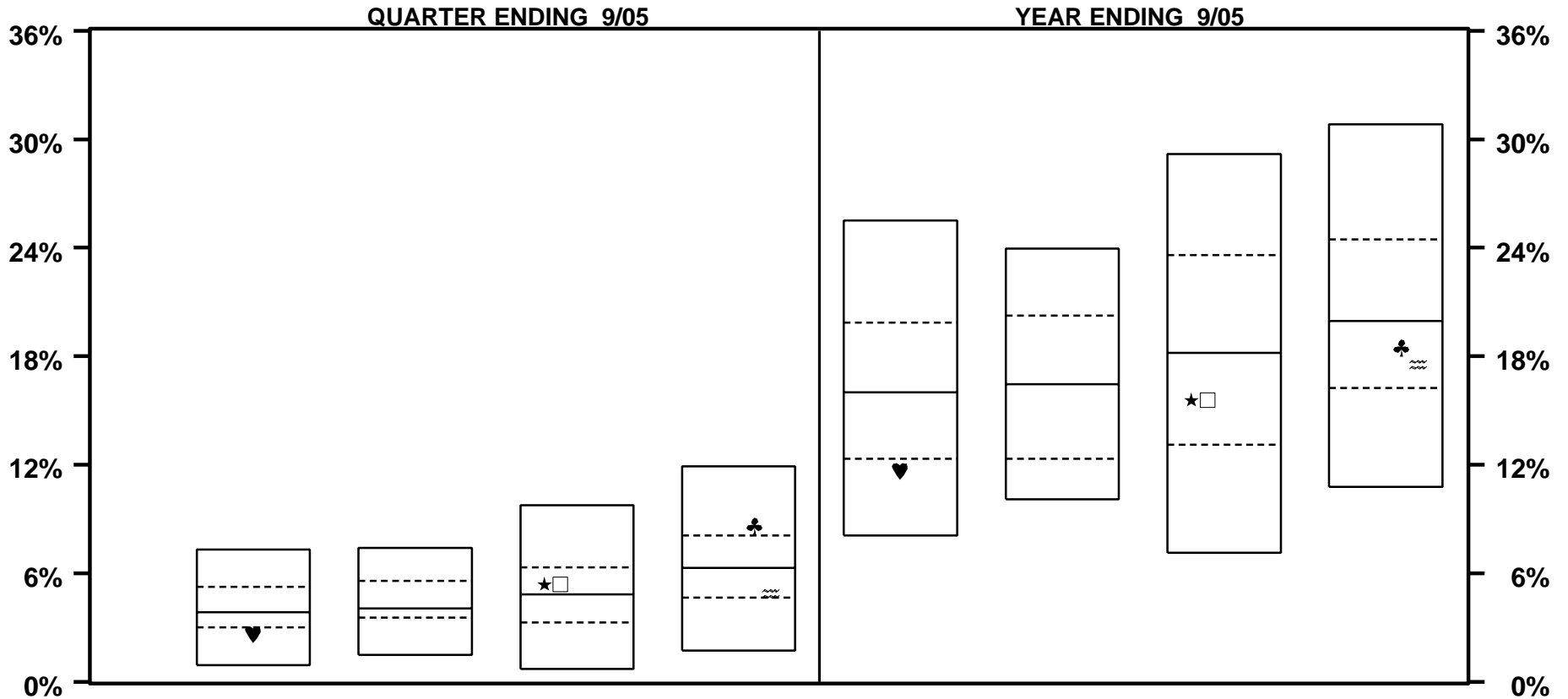

	QUARTER ENDING 9/05				YEAR ENDING 9/05			
	BELOW 1.0	1.0-1.1	1.1-1.2	ABOVE 1.2	BELOW 1.0	1.0-1.1	1.1-1.2	ABOVE 1.2
★ MUNI COMPOSITE			5.4				15.6	
□ EQTY COMPOSITE			5.4				15.6	
♥ DELAWARE	2.7				11.7			
♣ ALLIANCE				8.6				18.5
≡ LAZARD				4.9				17.5
MEDIAN	3.9	4.1	4.8	6.3	16.0	16.4	18.2	19.9

VERMONT MUNICIPAL EMPLOYEES

EQUITY ONLY - RATES OF RETURN

COMPARED TO FUNDS WITH SIMILAR DIVERSIFICATION

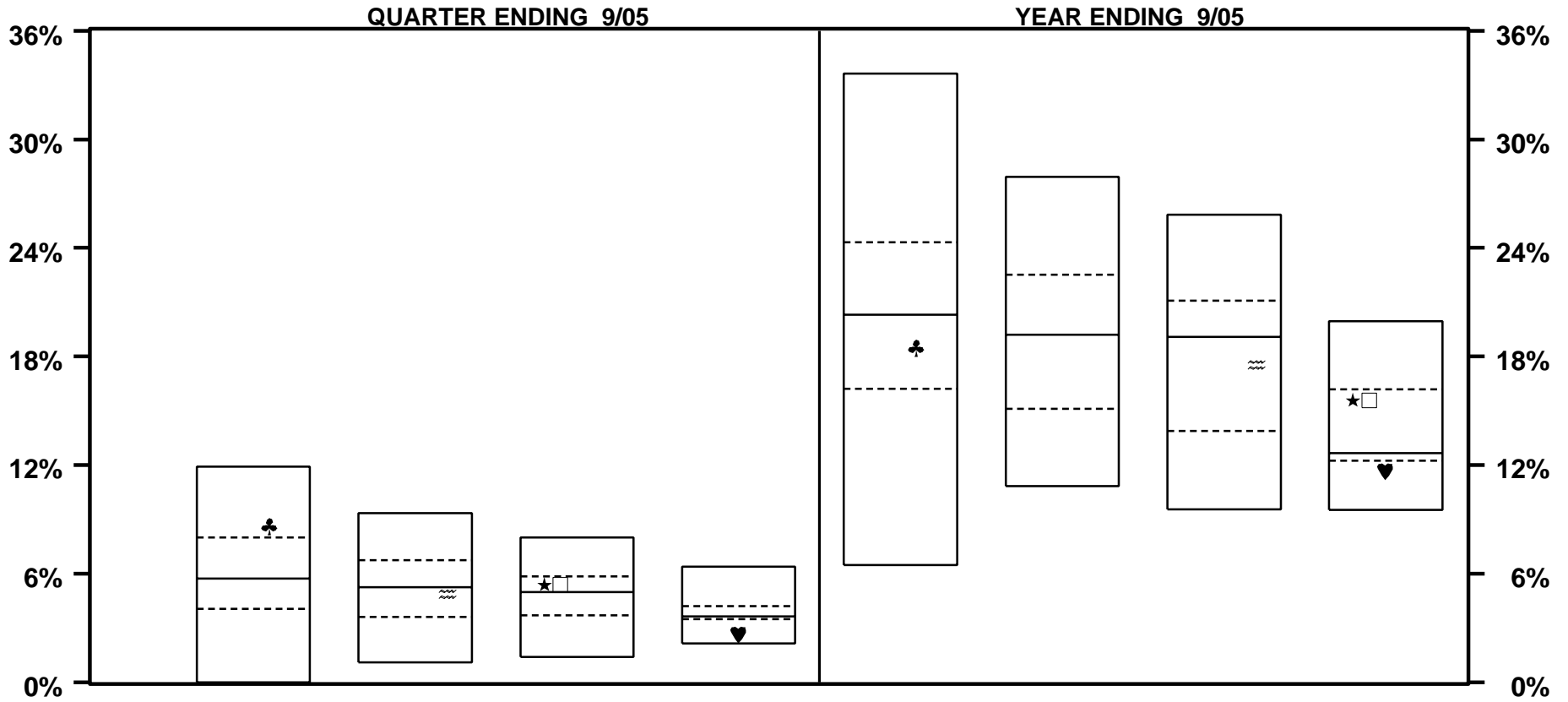

	BELOW 0.85	0.85- 0.90	0.90- 0.95	ABOVE 0.95	BELOW 0.85	0.85- 0.90	0.90- 0.95	ABOVE 0.95
★ MUNI COMPOSITE			5.4 40					15.6 28
□ EQTY COMPOSITE			5.4 40					15.6 28
♥ DELAWARE				2.7 91				11.7 86
♣ ALLIANCE	8.6 19				18.5 61			
≈ LAZARD		4.9 55					17.5 59	
MEDIAN	5.7	5.2	5.0	3.6	20.3	19.2	19.1	12.7

VERMONT MUNICIPAL EMPLOYEES

EQUITY ONLY - RATES OF RETURN

COMPARED TO FUNDS WITH SIMILAR P/E RATIO

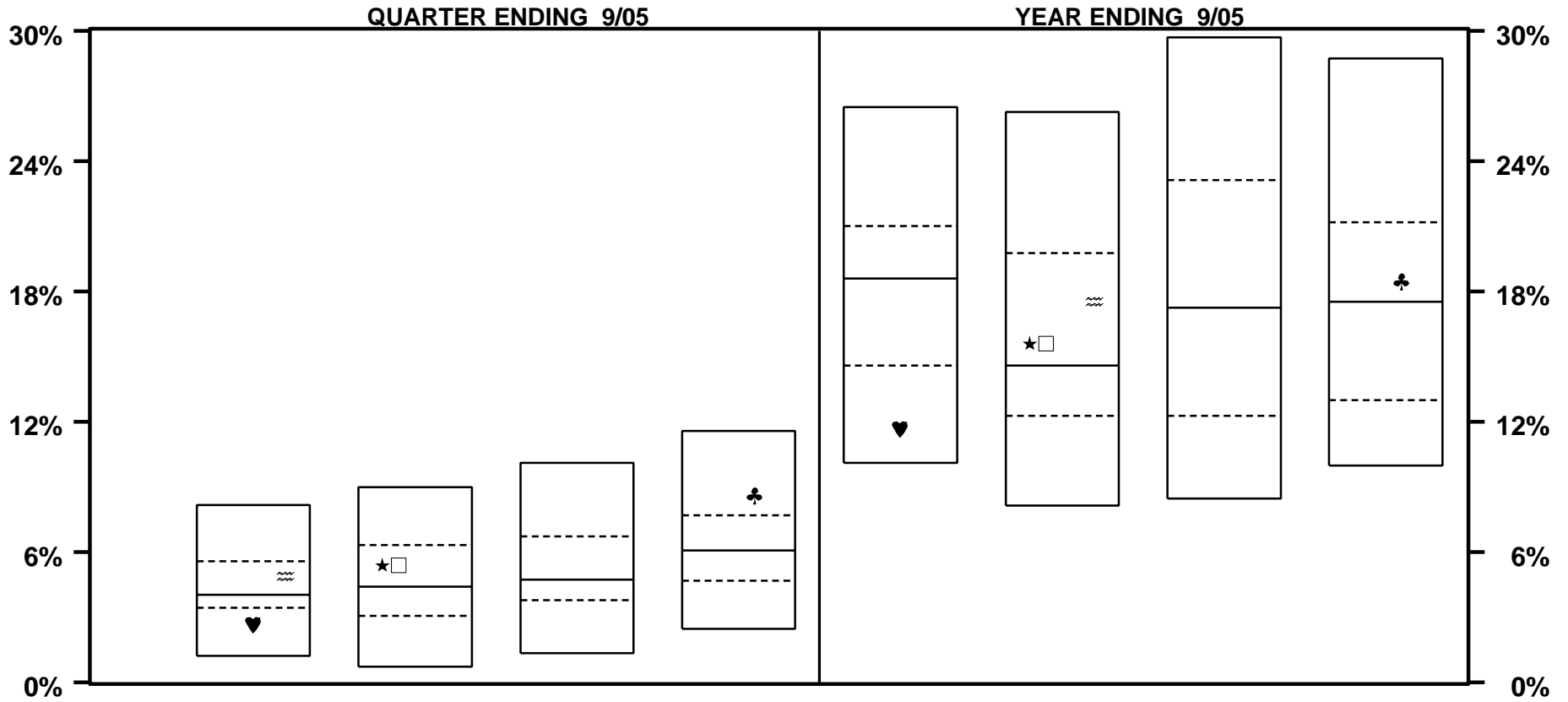

	QUARTER ENDING 9/05				YEAR ENDING 9/05			
	BELOW 17.5	17.5- 20.0	20.0- 22.5	ABOVE 22.5	BELOW 17.5	17.5- 20.0	20.0- 22.5	ABOVE 22.5
★ MUNI COMPOSITE		5.4				15.6		
□ EQTY COMPOSITE		5.4				15.6		
♥ DELAWARE	2.7				11.7			
♣ ALLIANCE				8.6				18.5
≍ LAZARD	4.9					17.5		
MEDIAN	4.0	4.4	4.7	6.1	18.6	14.6	17.2	17.5

VERMONT MUNICIPAL EMPLOYEES

EQUITY STYLE SPECTRUM METHODOLOGY

Background:

Equity Style Spectrum analysis is employed in characterizing the investment approach of a managed equity portfolio. It further provides the means for grouping equity portfolios with similar investment styles. While no rule-based methodology can claim to capture all of the decisions made by an investment manager, the size of the firm in which a manager invests and the fundamental growth or value orientation of portfolio constituent holdings serve to explain a significant portion of fund performance.

Exhibits:

The intersection of Size (Y-axis) and Value/Growth (X-axis) coordinates drive equity style spectrum mappings on a nine-quadrant grid. Each of the nine quadrants is bounded by both a metric of size and a measure of value, growth or neutrality. The style map depicts the magnitude of an individual manager's style bias while similarly identifying style gaps and redundancies among multiple investment managers. As style bias is characterized at points in time over extended intervals, the style map similarly captures any "style drift" that may be exhibited.

While portfolio-level assignments are driven by a weighted-average calculation of constituent holding size and value/growth scores, the portfolio cross-sectional distribution of such scores is of additional interest. Consider, for example, that a Mid Cap assignment can result from holding either a portfolio that is concentrated exclusively in mid cap stocks or alternatively as a result of holding both large and small cap names. Similarly, a Core assignment can be accorded to a portfolio that is wholly comprised of constituent holdings that have no style bias (neutral) or equivalently by holding securities that carry both a growth and value bias in equal proportion.

Methodology:

Size scores for constituent holdings are identically the risk index exposure values for Size as obtained from BARRA's US-E3 Equity Risk Model. The log of market capitalization is, in turn, employed in deriving the risk index exposure value.

The Value/Growth score associated with a given portfolio is derived by way of a probabilistic assesment of the tendency toward value and growth exhibited by its constituent portfolio holdings. Value is characterized through an aggregation of BARRA US-E3 risk index exposures to Earnings Yield, Book/Price ratio and Dividend Yield, respectively. Growth is assessed through a consideration of exposure to the US-E3 Growth index.

Size quadrants are bounded per:

Small: Size Exposure < -1.90
Mid: -1.90 <= Size Exposure <= -1.00
Large: Size Exposure > -1.00

Value/Growth quadrants are bounded per:

Value: Value/Growth Exposure < -0.15
Core: -0.15 <= Value/Growth Exposure <= 0.15
Growth: Value/Growth Exposure > 0.15

VERMONT MUNICIPAL EMPLOYEES

EQUITY MANAGER SPECTRUM STYLE ANALYSIS - TOTAL RETURNS

QUARTER ENDING 9/05

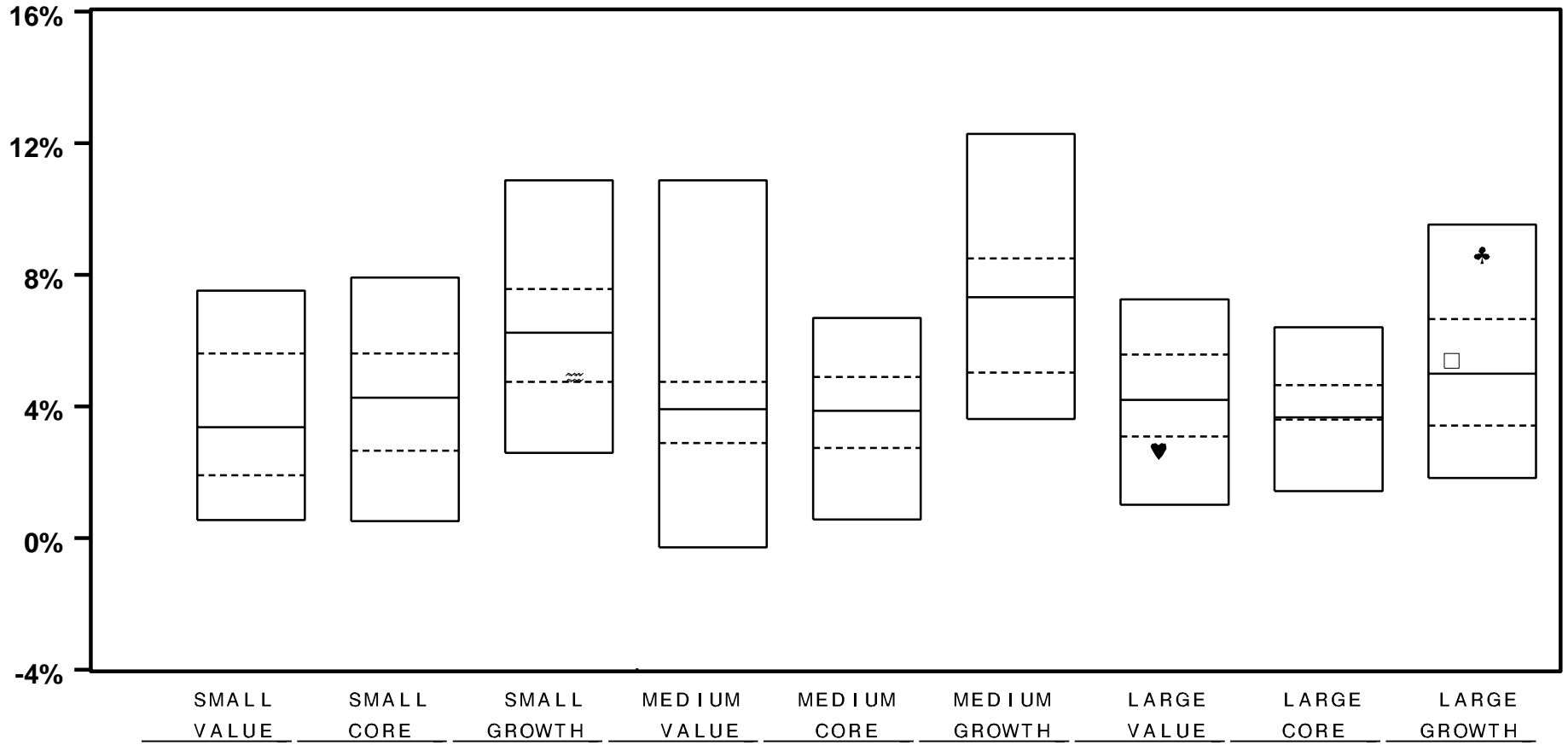

□	EQTY COMPOSITE								5.4	43
♥	DELAWARE							2.6	82	
♣	ALLIANCE								8.6	7
≍	LAZARD			4.9	71					
MEDIAN		3.4	4.3	6.2	3.9	3.9	7.3	4.2	3.7	5.0

VERMONT MUNICIPAL EMPLOYEES

EQUITY MANAGER SPECTRUM STYLE ANALYSIS - TOTAL RETURNS

YEAR ENDING 9/05

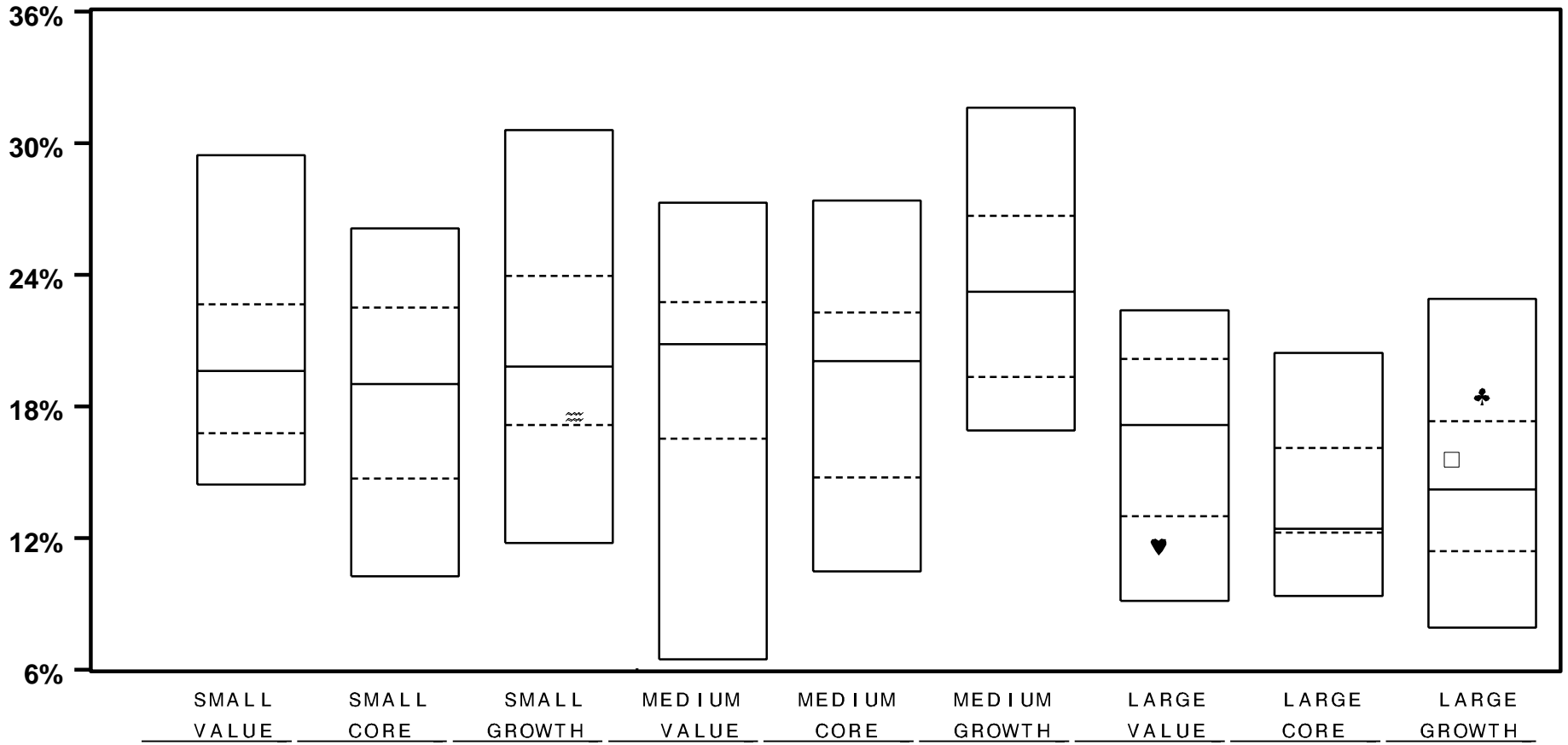

	SMALL VALUE	SMALL CORE	SMALL GROWTH	MEDIUM VALUE	MEDIUM CORE	MEDIUM GROWTH	LARGE VALUE	LARGE CORE	LARGE GROWTH
EQTY COMPOSITE									15.6 41
DELAWARE							11.6 84		
ALLIANCE									18.5 22
LAZARD			17.5 72						
MEDIAN	19.6	19.0	19.8	20.8	20.1	23.2	17.2	12.4	14.2

VERMONT MUNICIPAL EMPLOYEES

EQUITY MANAGER SPECTRUM STYLE ANALYSIS - TOTAL RETURNS

TWO YEARS ENDING 9/05

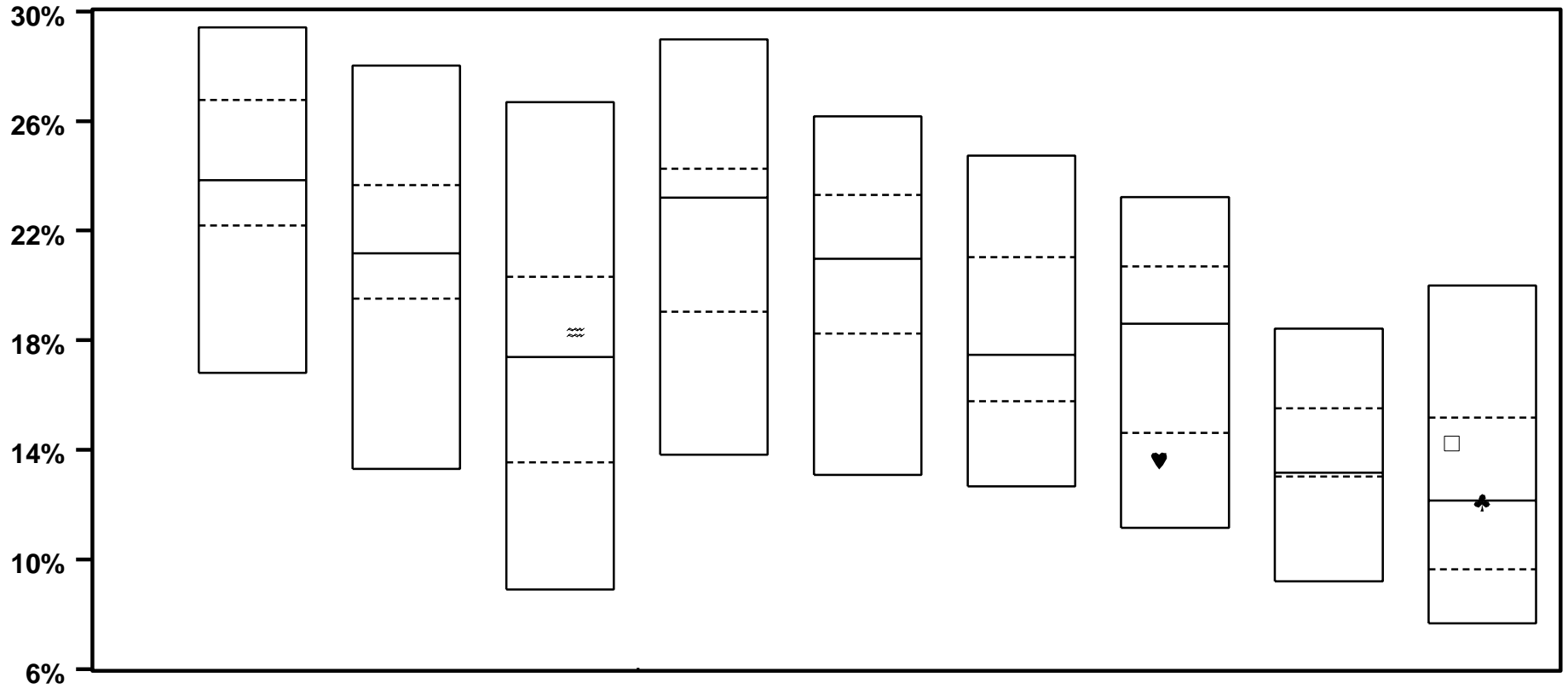

	SMALL VALUE	SMALL CORE	SMALL GROWTH	MEDIUM VALUE	MEDIUM CORE	MEDIUM GROWTH	LARGE VALUE	LARGE CORE	LARGE GROWTH
EQTY COMPOSITE									14.2 34
DELAWARE							13.6 83		
ALLIANCE									12.1 50
LAZARD			18.3 37						
MEDIAN	23.9	21.2	17.4	23.2	21.0	17.5	18.6	13.2	12.2

VERMONT MUNICIPAL EMPLOYEES

EQUITY MANAGER SPECTRUM STYLE ANALYSIS - TOTAL RETURNS

THREE YEARS ENDING 9/05

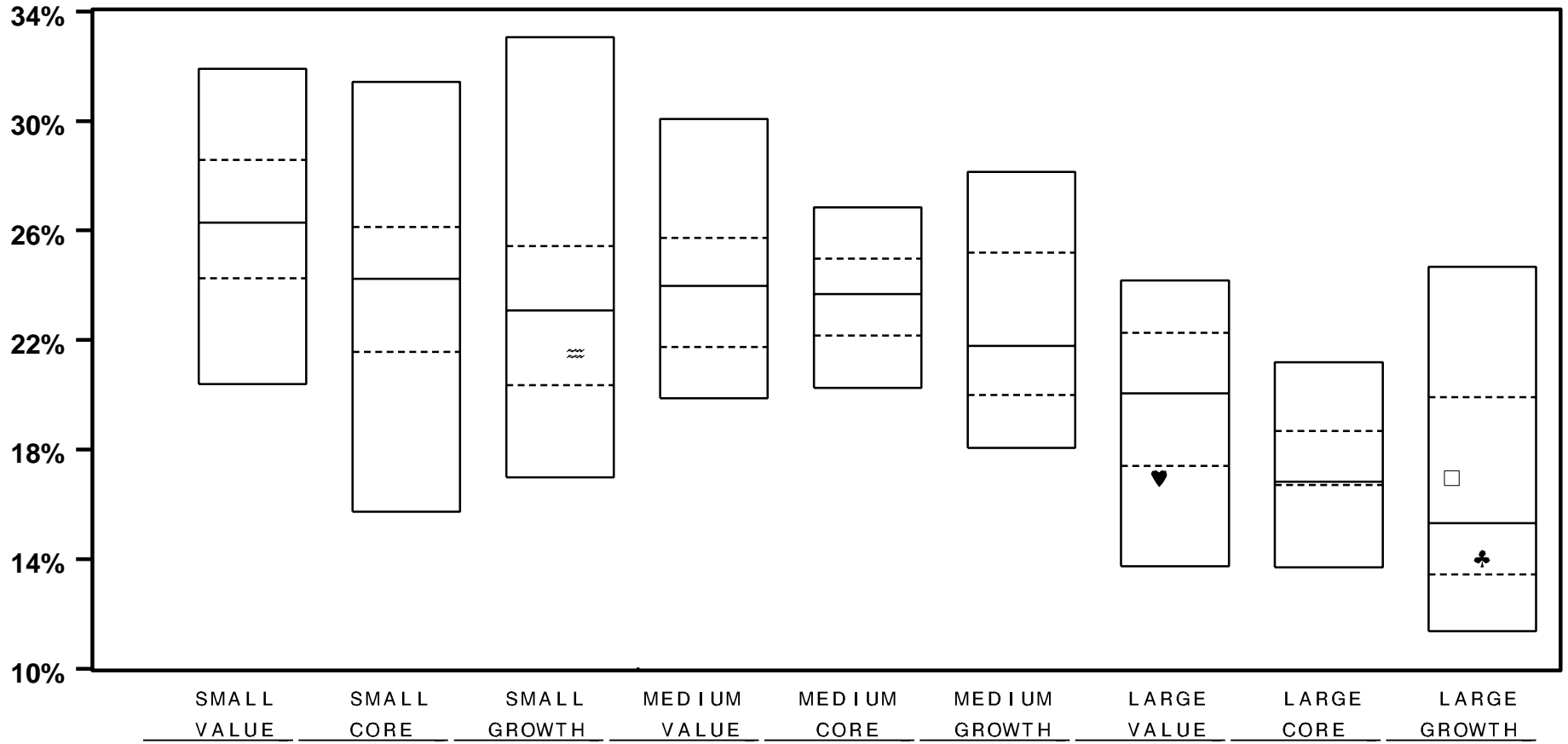

- EQTY COMPOSITE
- ♥ DELAWARE
- ♣ ALLIANCE
- ≡ LAZARD

									17.0	41
									17.0	79
									14.0	65

			21.5	64						
MEDIAN	26.3	24.2	23.1	24.0	23.7	21.8	20.1	16.8	15.3	

VERMONT MUNICIPAL EMPLOYEES

EQUITY MANAGER SPECTRUM STYLE ANALYSIS - TOTAL RETURNS

FOUR YEARS ENDING 9/05

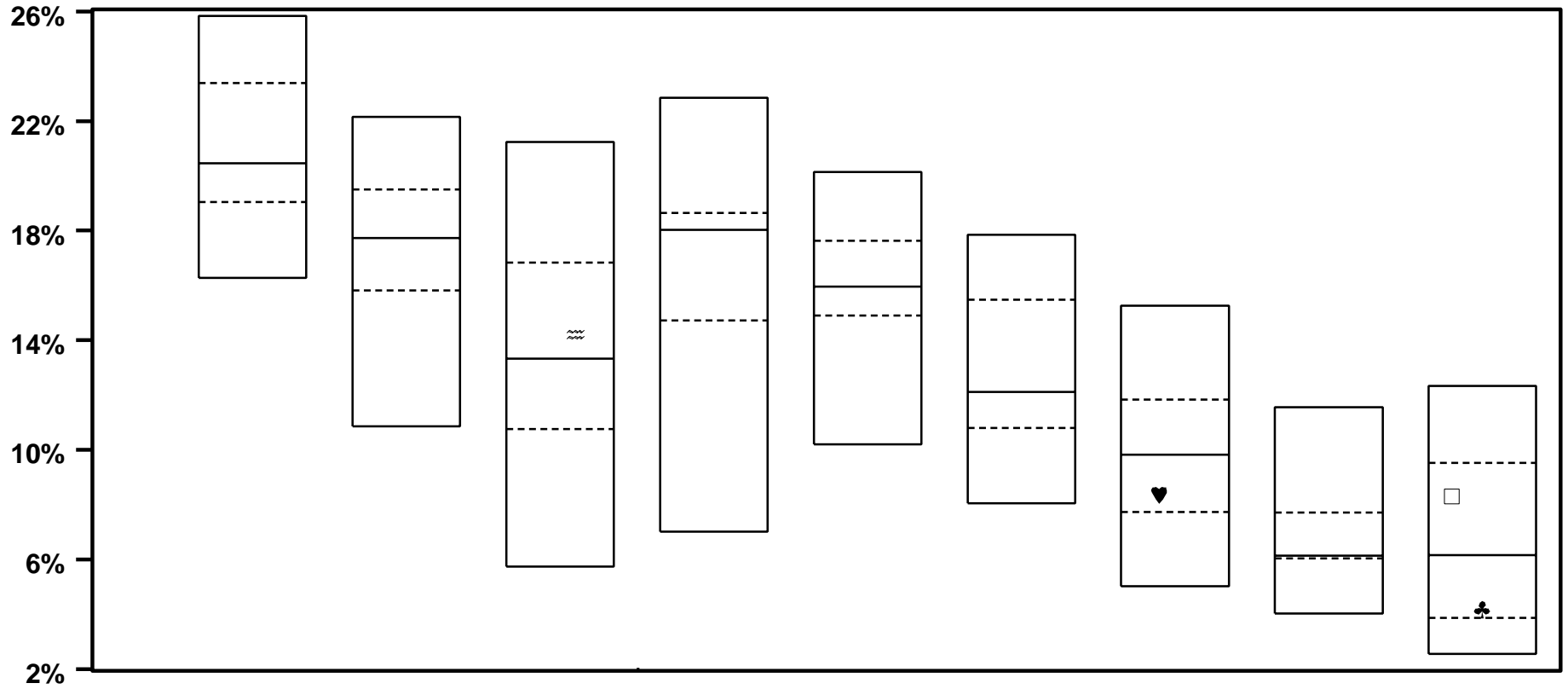

	SMALL VALUE	SMALL CORE	SMALL GROWTH	MEDIUM VALUE	MEDIUM CORE	MEDIUM GROWTH	LARGE VALUE	LARGE CORE	LARGE GROWTH
EQTY COMPOSITE									8.3 31
DELAWARE							8.4 63		
ALLIANCE									4.2 65
LAZARD			14.2 42						
MEDIAN	20.4	17.7	13.3	18.0	16.0	12.1	9.8	6.1	6.2

VERMONT MUNICIPAL EMPLOYEES

EQUITY MANAGER SPECTRUM STYLE ANALYSIS - TOTAL RETURNS

FIVE YEARS ENDING 9/05

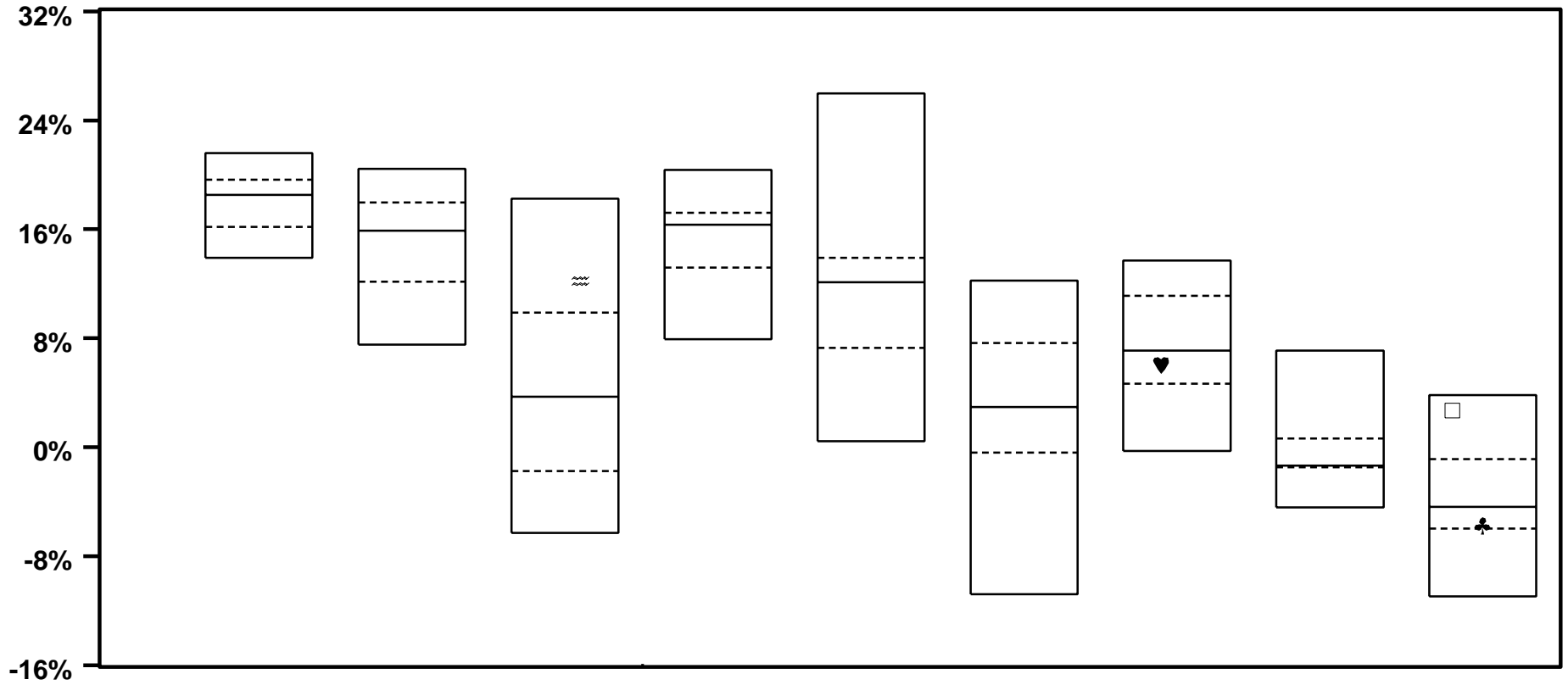

	SMALL VALUE	SMALL CORE	SMALL GROWTH	MEDIUM VALUE	MEDIUM CORE	MEDIUM GROWTH	LARGE VALUE	LARGE CORE	LARGE GROWTH
EQTY COMPOSITE									2.7 9
DELAWARE							6.1 58		
ALLIANCE									-5.7 69
LAZARD			12.2 19						
MEDIAN	18.5	15.9	3.7	16.3	12.1	2.9	7.1	-1.3	-4.4

VERMONT MUNICIPAL EMPLOYEES

EQUITY MANAGER SPECTRUM STYLE ANALYSIS - TOTAL RETURNS

YEAR ENDING 9/04

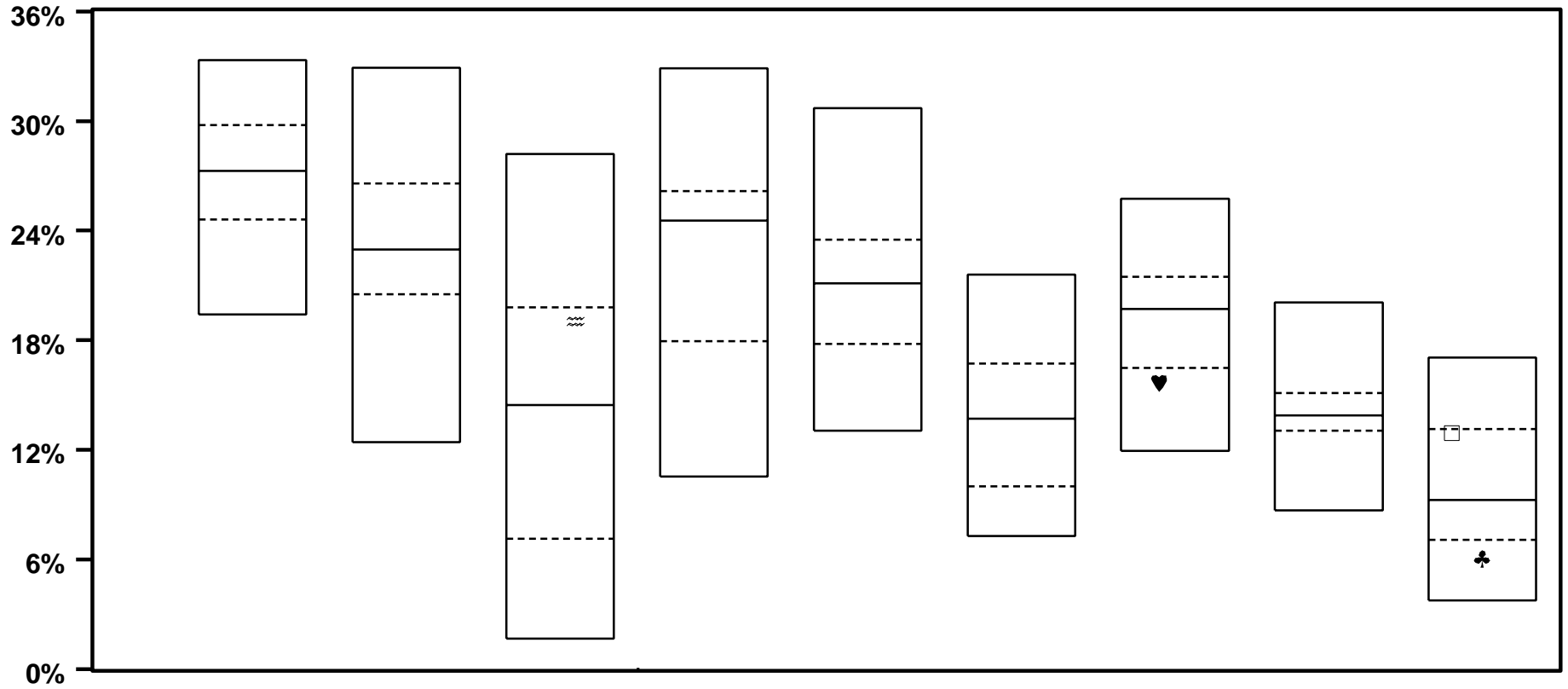

	SMALL VALUE	SMALL CORE	SMALL GROWTH	MEDIUM VALUE	MEDIUM CORE	MEDIUM GROWTH	LARGE VALUE	LARGE CORE	LARGE GROWTH
EQTY COMPOSITE									12.9 25
DELAWARE							15.7 78		
ALLIANCE									6.1 85
LAZARD			19.1 27						
MEDIAN	27.3	23.0	14.5	24.6	21.1	13.7	19.7	13.9	9.3

VERMONT MUNICIPAL EMPLOYEES

EQUITY MANAGER SPECTRUM STYLE ANALYSIS - TOTAL RETURNS

YEAR ENDING 9/03

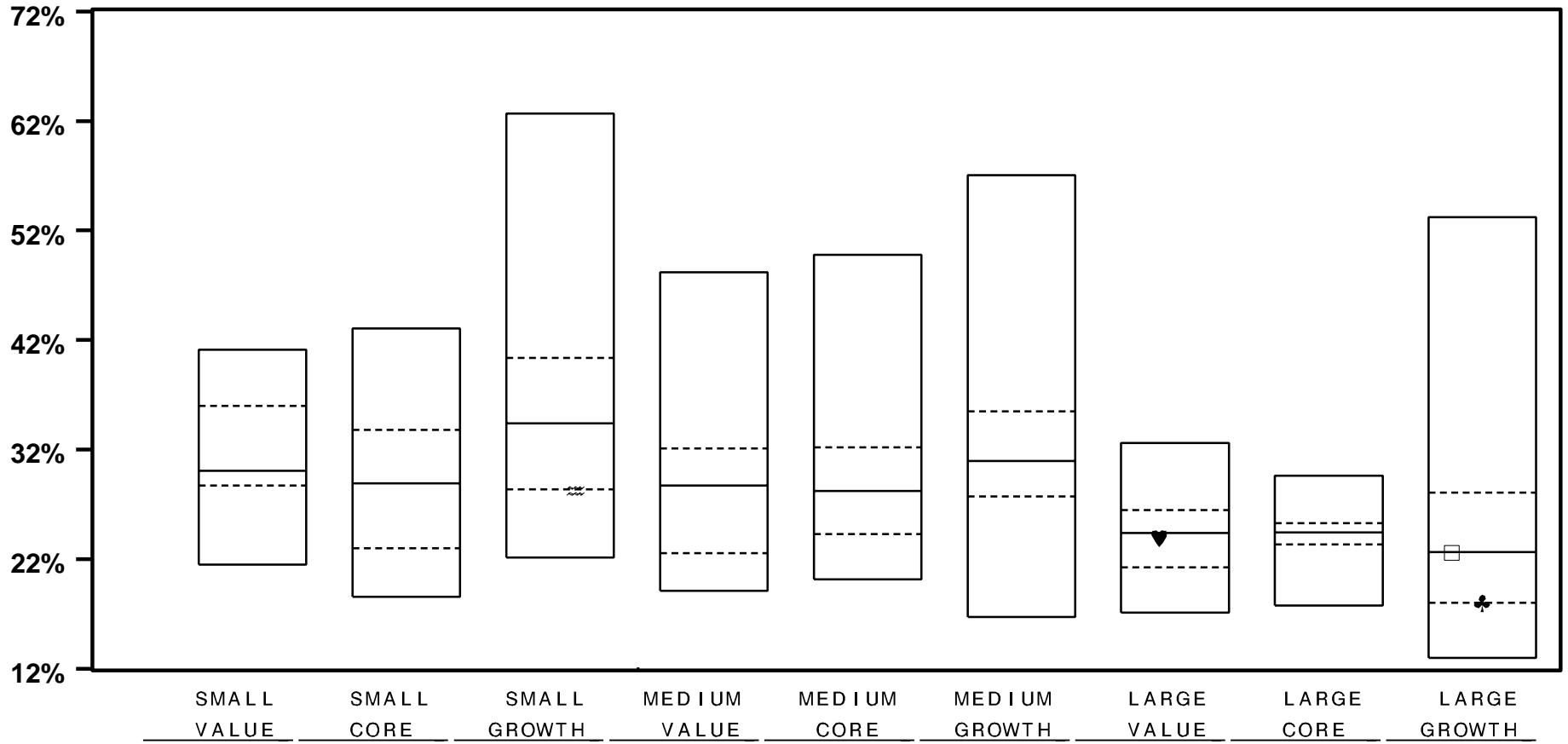

	SMALL VALUE	SMALL CORE	SMALL GROWTH	MEDIUM VALUE	MEDIUM CORE	MEDIUM GROWTH	LARGE VALUE	LARGE CORE	LARGE GROWTH
EQTY COMPOSITE									22.6 50
DELAWARE							24.0 55		
ALLIANCE									18.0 75
LAZARD			28.2 76						
MEDIAN	30.1	28.9	34.4	28.7	28.2	31.0	24.4	24.4	22.6

VERMONT MUNICIPAL EMPLOYEES

EQUITY MANAGER SPECTRUM STYLE ANALYSIS - TOTAL RETURNS

YEAR ENDING 9/02

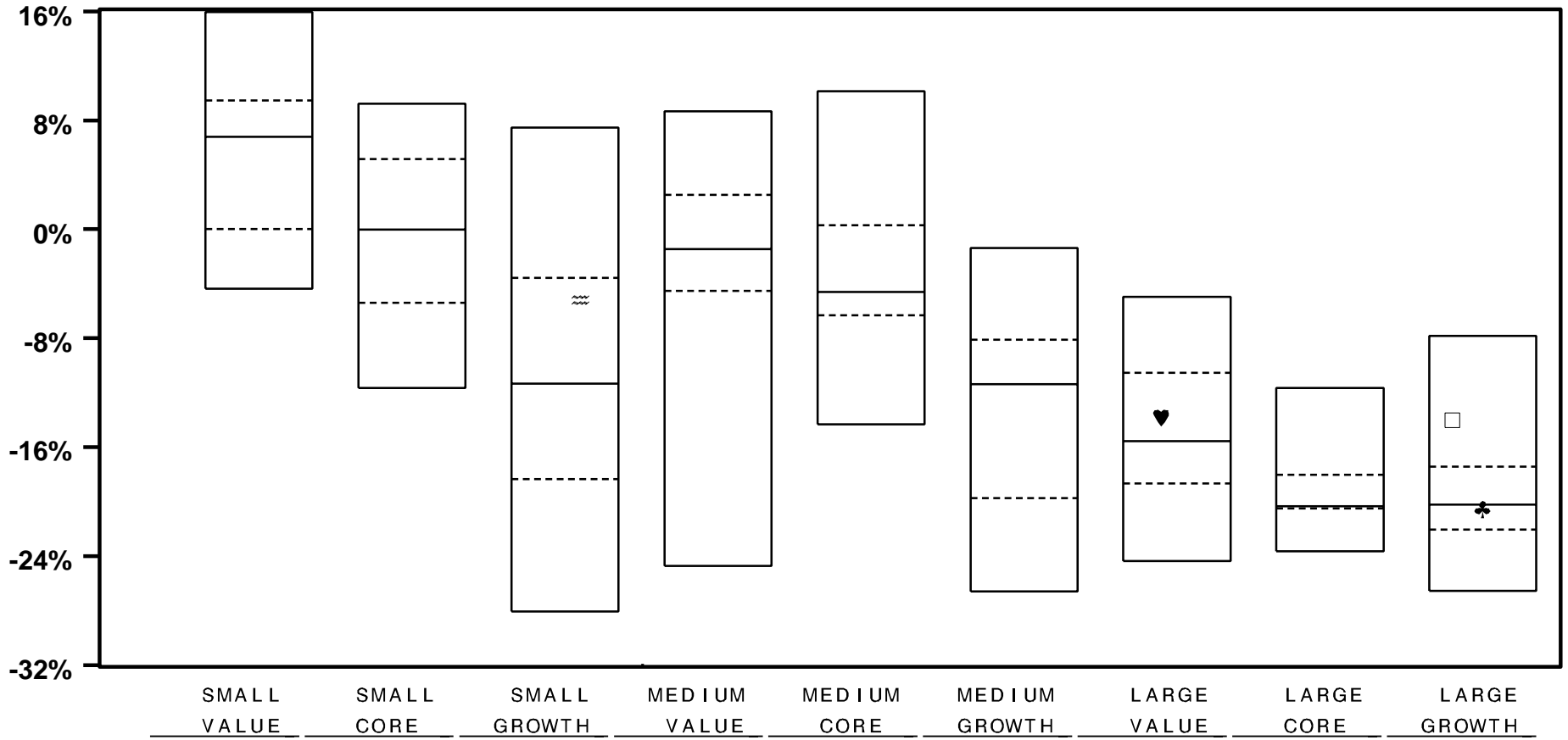

	SMALL VALUE	SMALL CORE	SMALL GROWTH	MEDIUM VALUE	MEDIUM CORE	MEDIUM GROWTH	LARGE VALUE	LARGE CORE	LARGE GROWTH
EQTY COMPOSITE									-14.0 16
DELAWARE							-13.8 38		
ALLIANCE									-20.5 56
LAZARD			-5.2 30						
MEDIAN	6.8	0.0	-11.3	-1.4	-4.6	-11.4	-15.6	-20.3	-20.2

VERMONT MUNICIPAL EMPLOYEES

EQUITY MANAGER SPECTRUM STYLE ANALYSIS - TOTAL RETURNS

YEAR ENDING 9/01

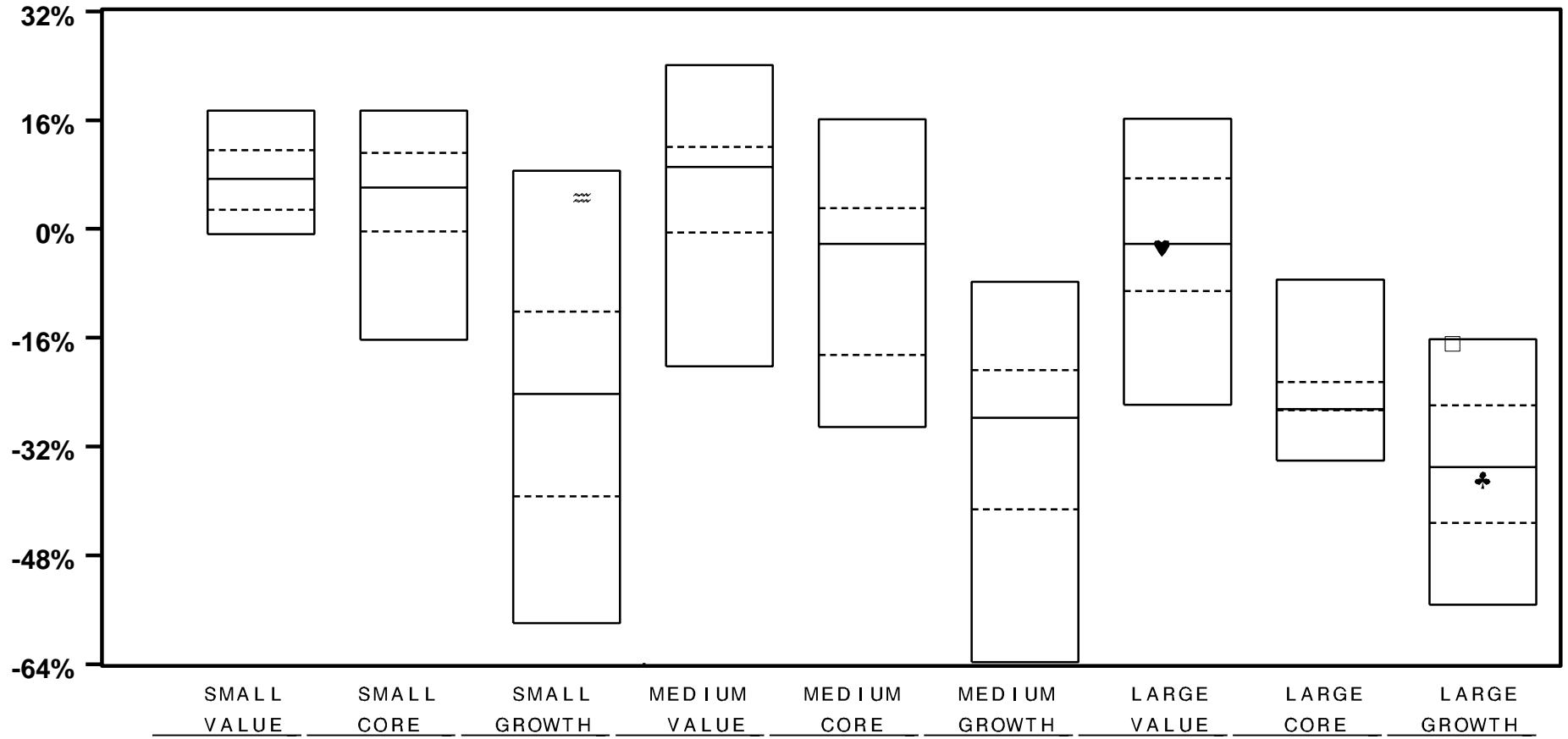

- EQTY COMPOSITE
- ♥ DELAWARE
- ♣ ALLIANCE
- ≡ LAZARD

- 2.7 51
- 16.9 7
- 36.9 56

MEDIAN 7.3 6.1 -24.3 9.1 -2.2 -27.8 -2.2 -26.5 -35.0

VERMONT MUNICIPAL EMPLOYEES

EQUITY MANAGER SPECTRUM STYLE ANALYSIS - TOTAL RETURNS

YEAR ENDING 9/00

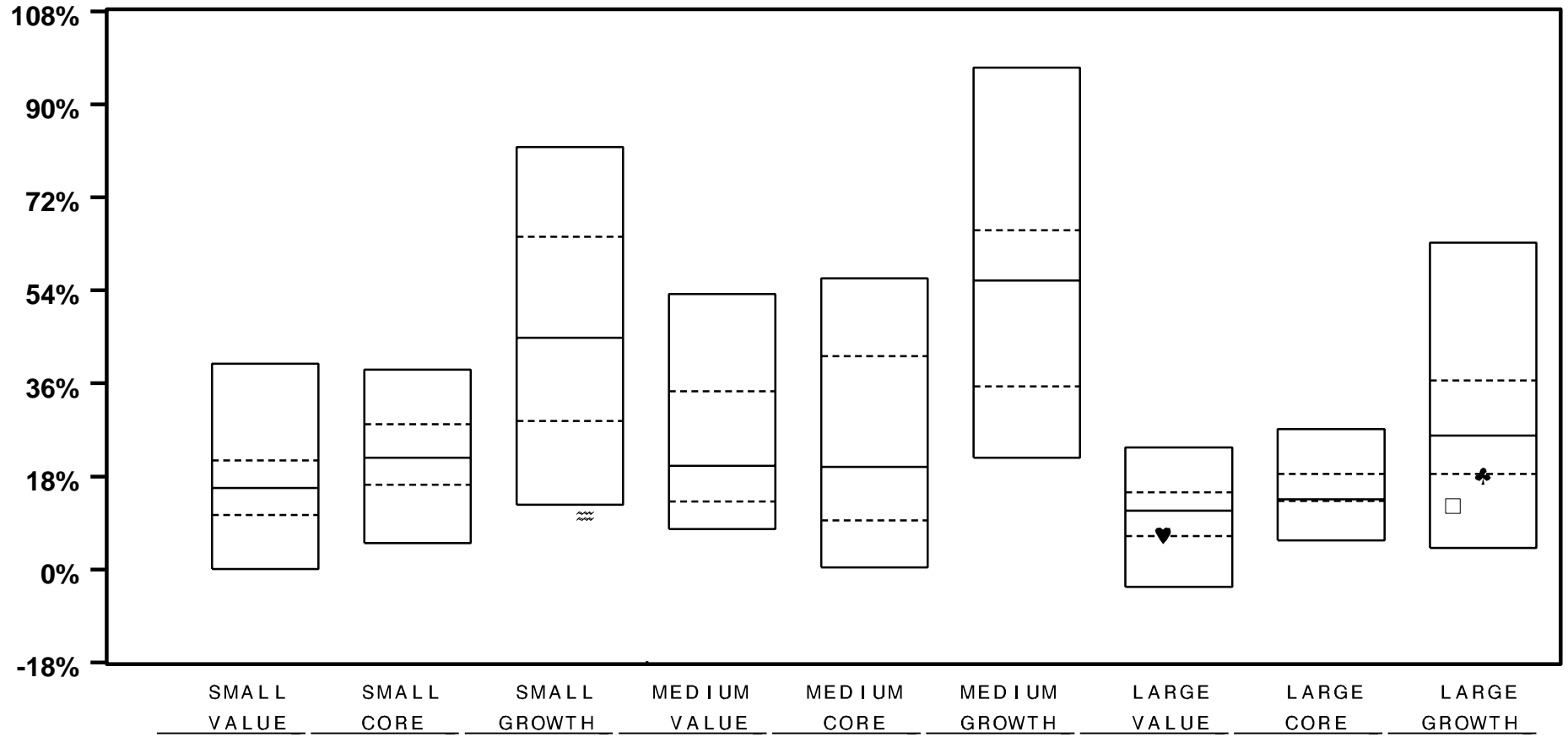

	SMALL VALUE	SMALL CORE	SMALL GROWTH	MEDIUM VALUE	MEDIUM CORE	MEDIUM GROWTH	LARGE VALUE	LARGE CORE	LARGE GROWTH
EQTY COMPOSITE									12.3 87
DELAWARE							6.6 74		
ALLIANCE									18.1 77
LAZARD			10.4 96						
MEDIAN	15.8	21.6	44.8	20.0	19.9	55.9	11.3	13.5	25.9

VERMONT MUNICIPAL EMPLOYEES

EQUITY MANAGER SPECTRUM STYLE ANALYSIS - EQUITY ONLY RETURNS

QUARTER ENDING 9/05

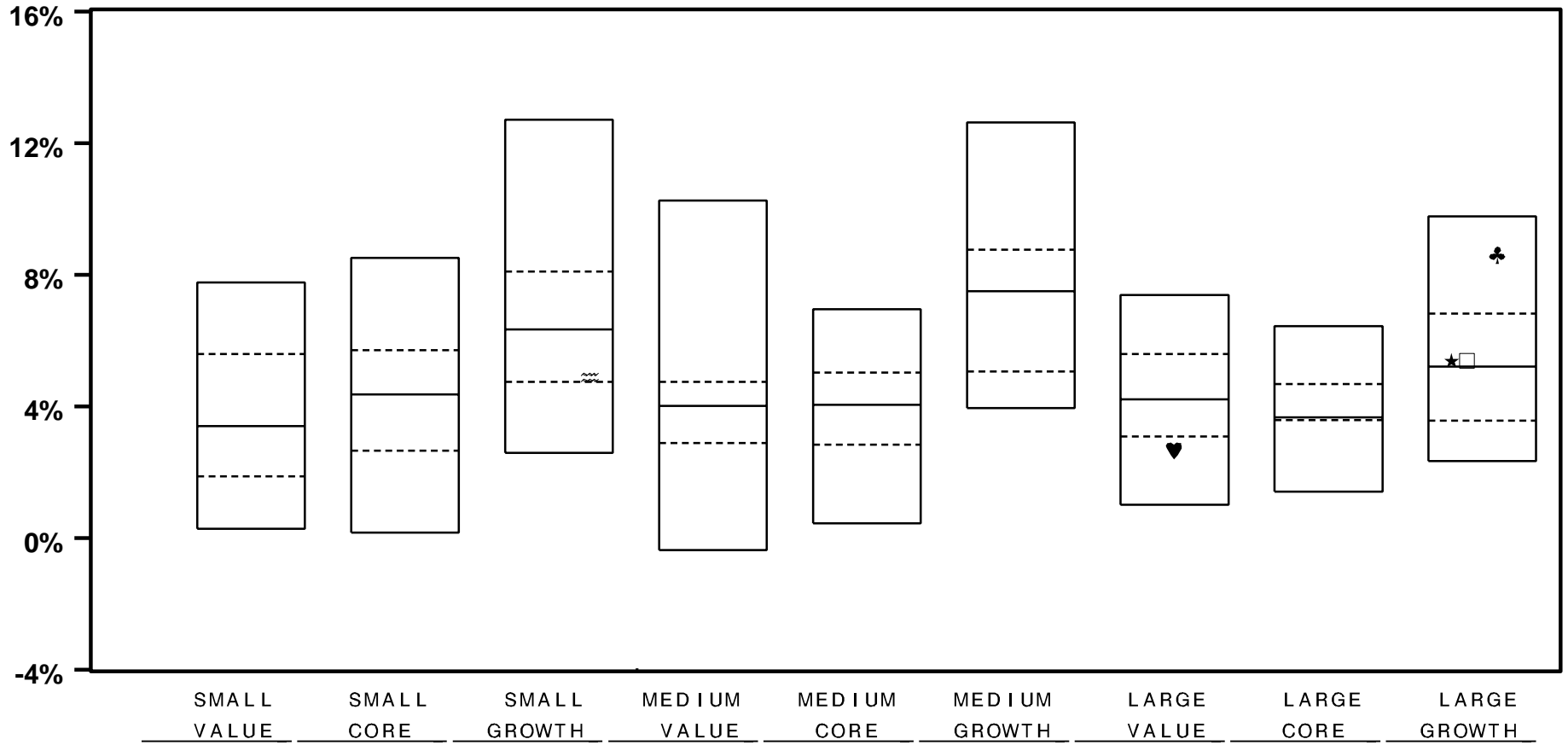

	SMALL VALUE	SMALL CORE	SMALL GROWTH	MEDIUM VALUE	MEDIUM CORE	MEDIUM GROWTH	LARGE VALUE	LARGE CORE	LARGE GROWTH
★ MUNI COMPOSITE									5.4 45
□ EQTY COMPOSITE									5.4 45
♥ DELAWARE							2.7 82		
♣ ALLIANCE									8.6 8
≈ LAZARD			4.9 72						
MEDIAN	3.4	4.4	6.3	4.0	4.0	7.5	4.2	3.7	5.2

VERMONT MUNICIPAL EMPLOYEES

EQUITY MANAGER SPECTRUM STYLE ANALYSIS - EQUITY ONLY RETURNS

YEAR ENDING 9/05

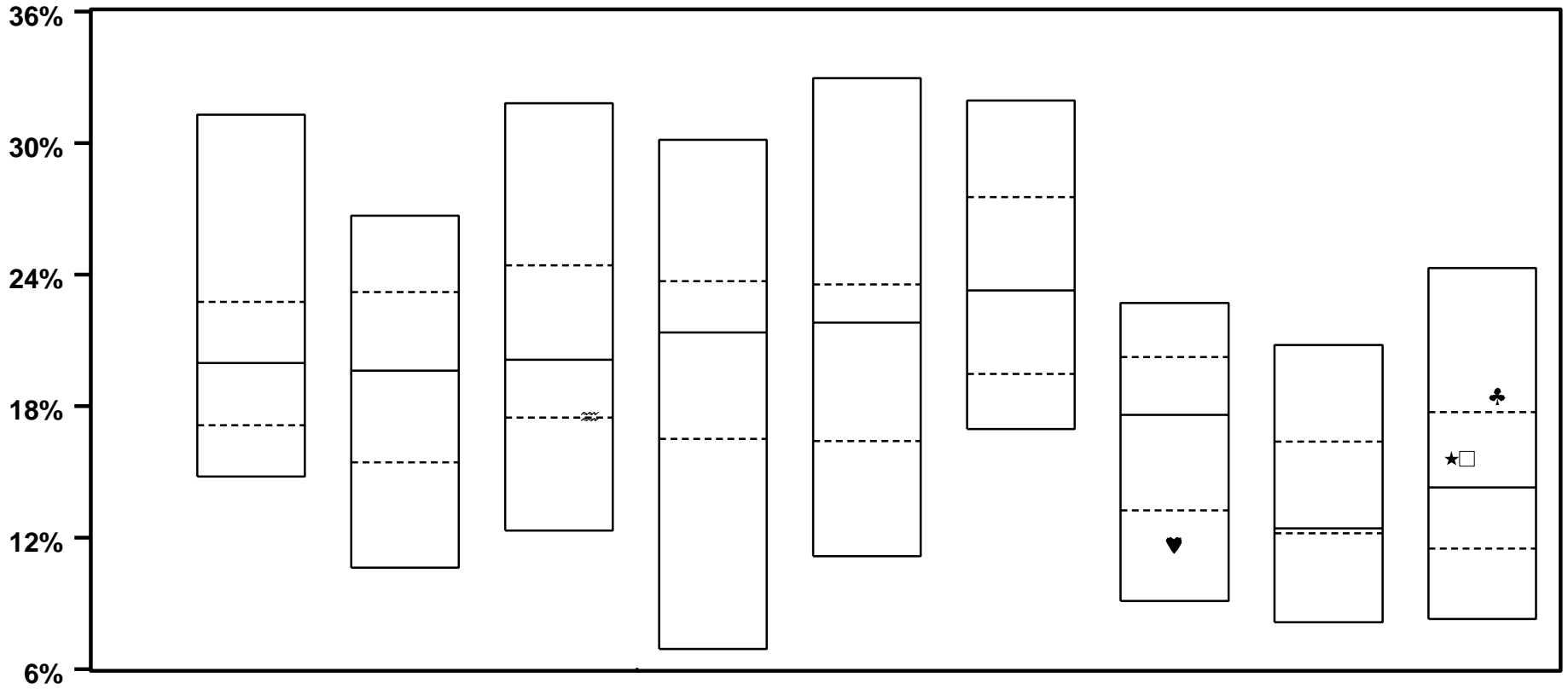

	SMALL VALUE	SMALL CORE	SMALL GROWTH	MEDIUM VALUE	MEDIUM CORE	MEDIUM GROWTH	LARGE VALUE	LARGE CORE	LARGE GROWTH
★ MUNI COMPOSITE									15.6 42
□ EQTY COMPOSITE									15.6 42
♥ DELAWARE							11.7 83		
♣ ALLIANCE									18.5 23
≈ LAZARD			17.5 74						
MEDIAN	20.0	19.6	20.1	21.4	21.8	23.3	17.6	12.4	14.3

VERMONT MUNICIPAL EMPLOYEES

EQUITY MANAGER SPECTRUM STYLE ANALYSIS - EQUITY ONLY RETURNS

TWO YEARS ENDING 9/05

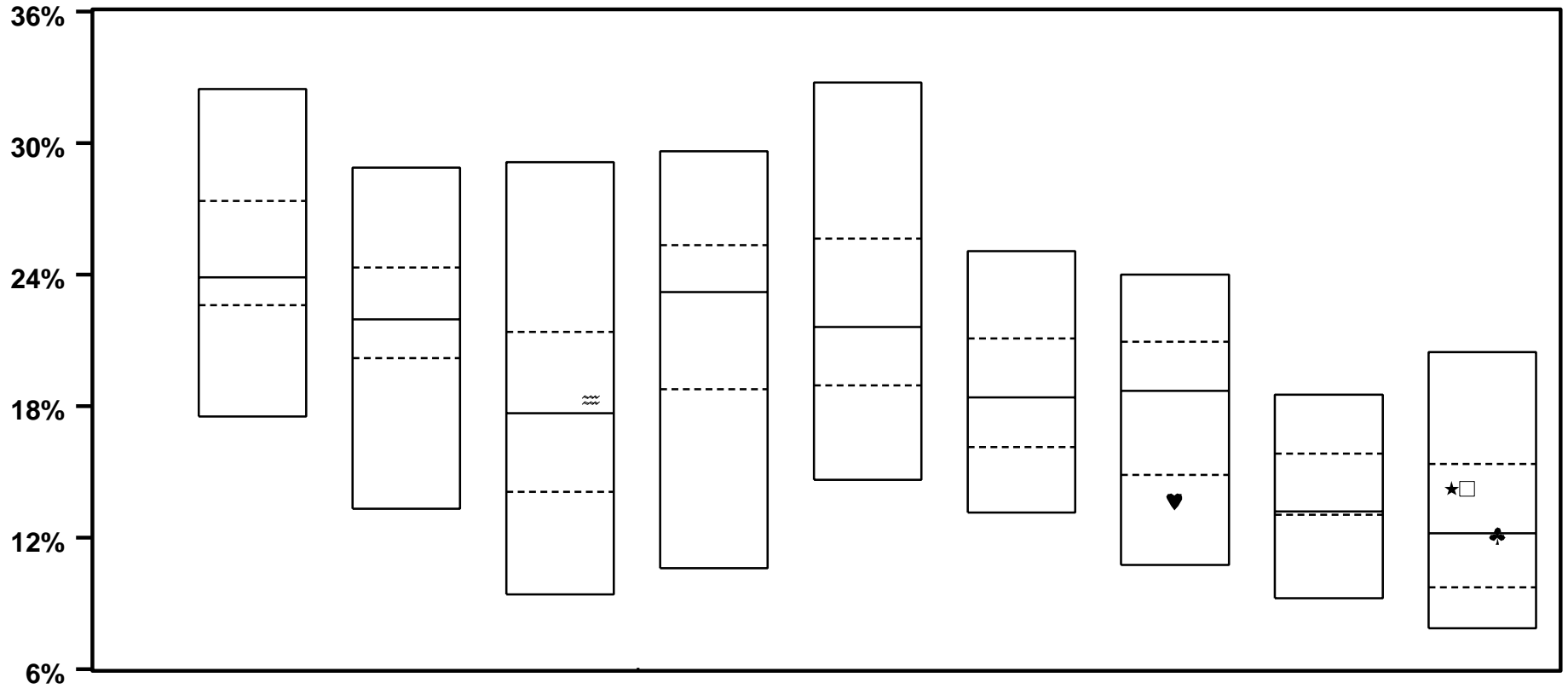

	SMALL VALUE	SMALL CORE	SMALL GROWTH	MEDIUM VALUE	MEDIUM CORE	MEDIUM GROWTH	LARGE VALUE	LARGE CORE	LARGE GROWTH
★ MUNI COMPOSITE									14.2 35
□ EQTY COMPOSITE									14.2 35
♥ DELAWARE							13.7 84		
♣ ALLIANCE									12.1 50
≈ LAZARD			18.3 42						
MEDIAN	23.9	22.0	17.7	23.2	21.6	18.4	18.7	13.2	12.2

VERMONT MUNICIPAL EMPLOYEES

EQUITY MANAGER SPECTRUM STYLE ANALYSIS - EQUITY ONLY RETURNS

THREE YEARS ENDING 9/05

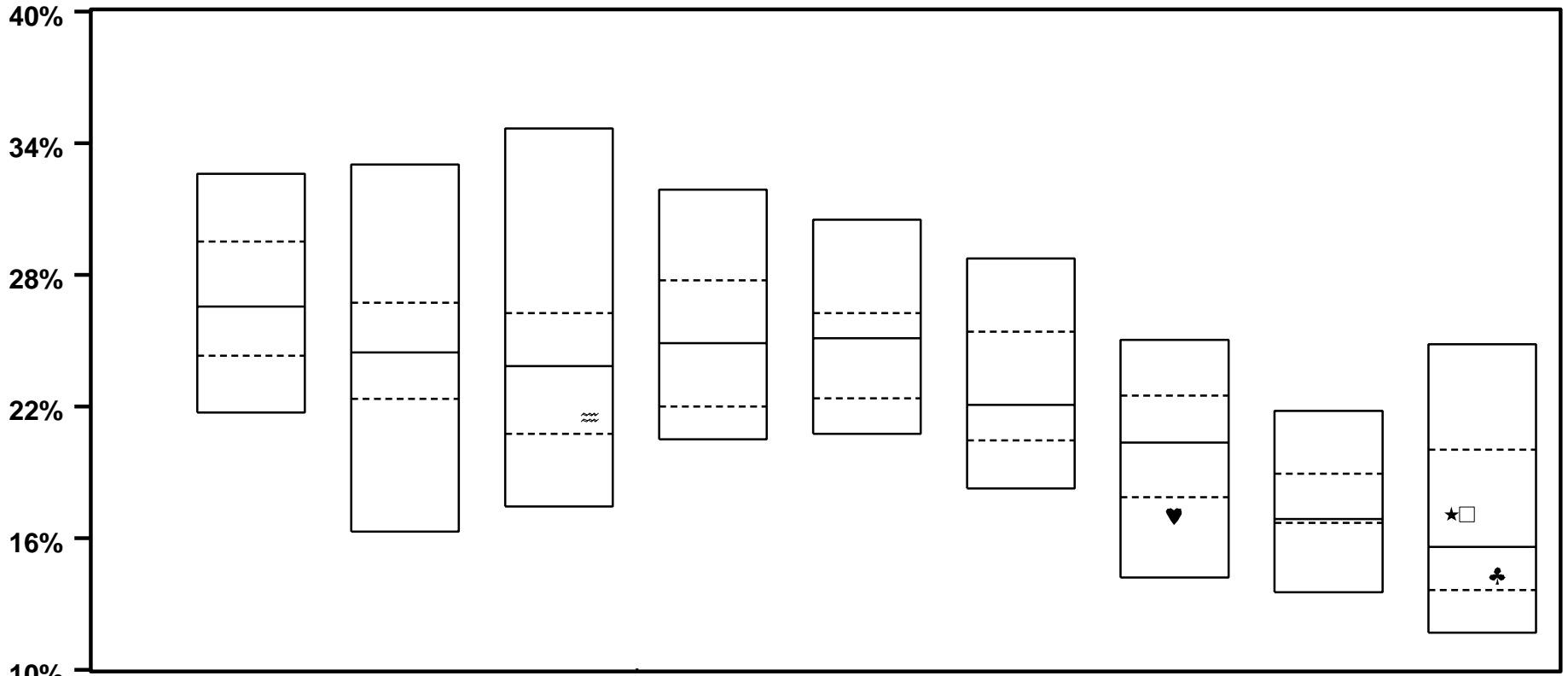

	SMALL VALUE	SMALL CORE	SMALL GROWTH	MEDIUM VALUE	MEDIUM CORE	MEDIUM GROWTH	LARGE VALUE	LARGE CORE	LARGE GROWTH
★ MUNI COMPOSITE									17.1 40
□ EQTY COMPOSITE									17.1 40
♥ DELAWARE							17.0 81		
♣ ALLIANCE									14.3 63
≈ LAZARD			21.5 69						
MEDIAN	26.6	24.4	23.8	24.9	25.1	22.1	20.3	16.9	15.6

VERMONT MUNICIPAL EMPLOYEES

EQUITY MANAGER SPECTRUM STYLE ANALYSIS - EQUITY ONLY RETURNS

FOUR YEARS ENDING 9/05

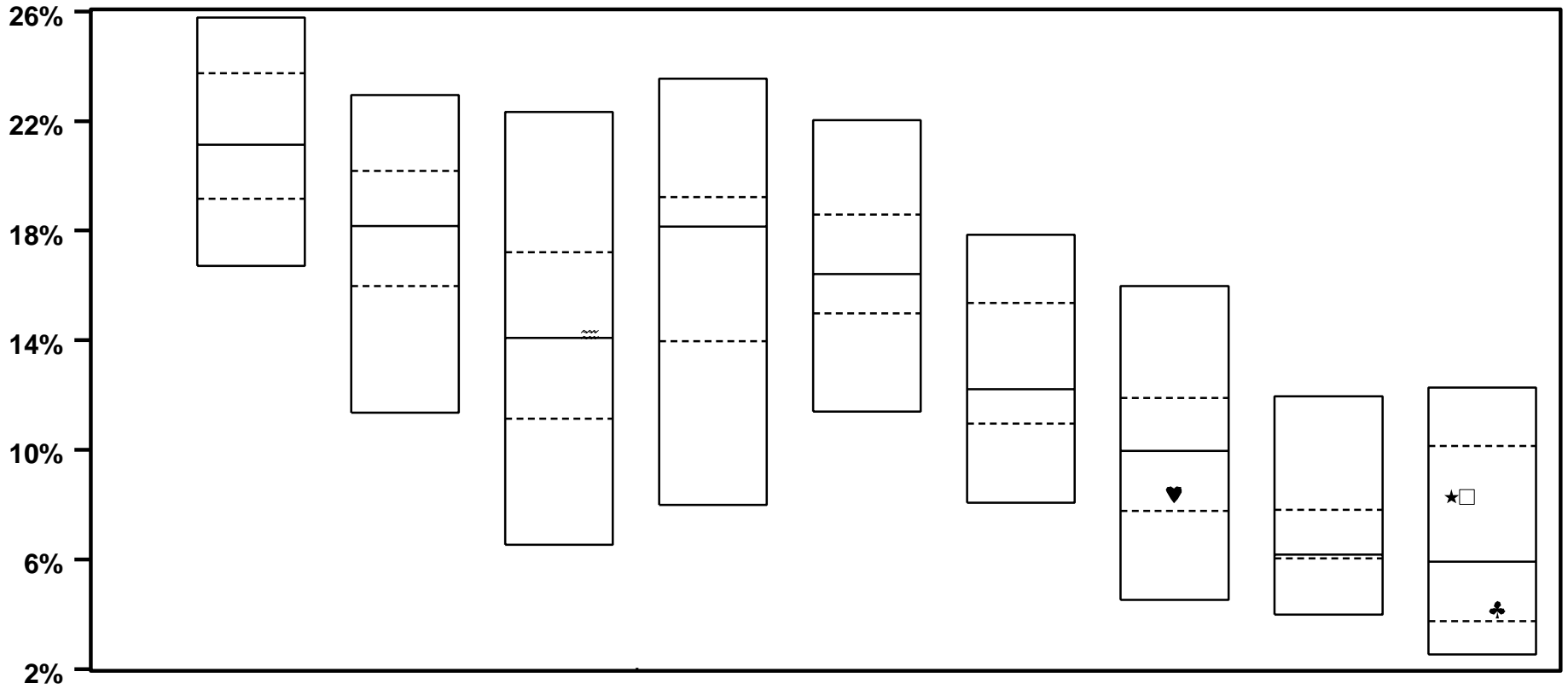

	SMALL VALUE	SMALL CORE	SMALL GROWTH	MEDIUM VALUE	MEDIUM CORE	MEDIUM GROWTH	LARGE VALUE	LARGE CORE	LARGE GROWTH
★ MUNI COMPOSITE									8.3 32
□ EQTY COMPOSITE									8.3 32
♥ DELAWARE							8.4 65		
♣ ALLIANCE									4.2 62
≈ LAZARD			14.2 48						
MEDIAN	21.1	18.2	14.1	18.1	16.4	12.2	10.0	6.2	5.9

VERMONT MUNICIPAL EMPLOYEES

EQUITY MANAGER SPECTRUM STYLE ANALYSIS - EQUITY ONLY RETURNS

FIVE YEARS ENDING 9/05

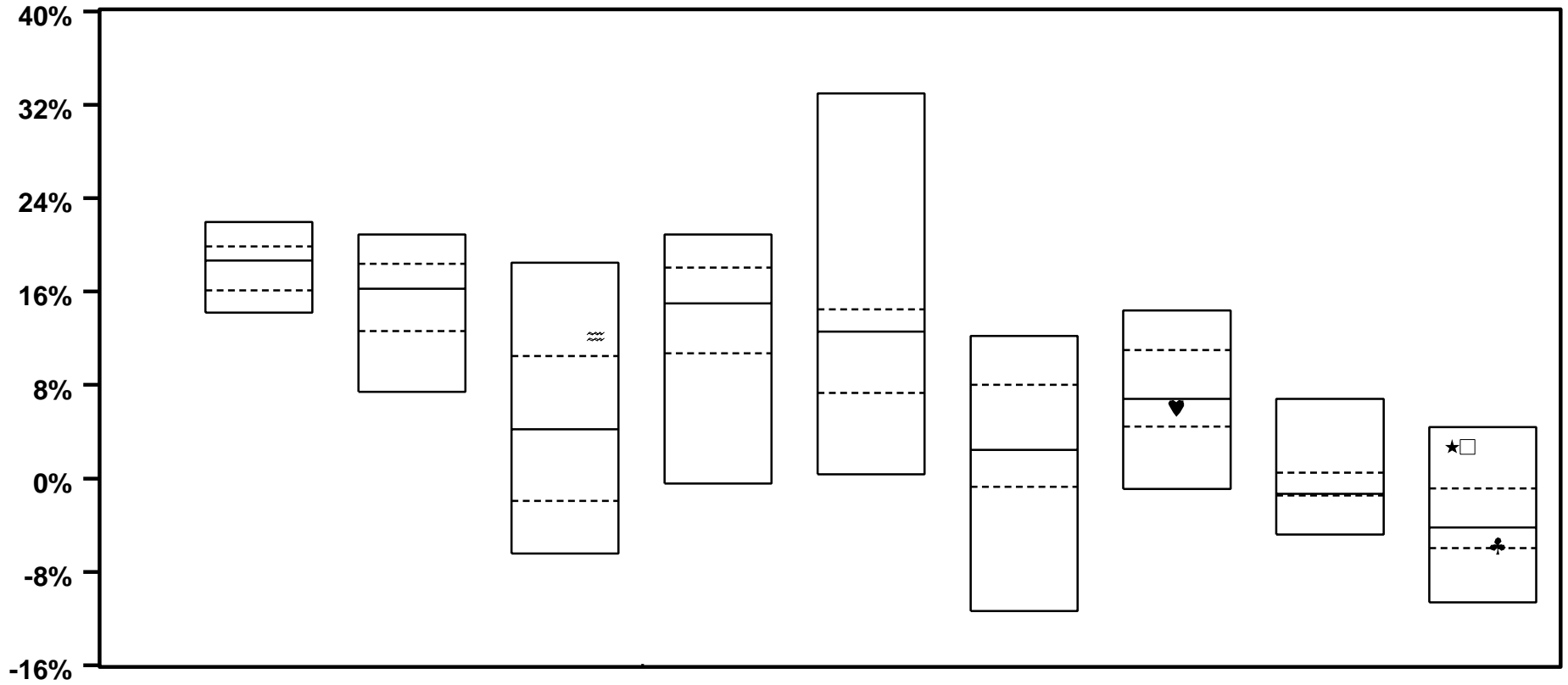

	SMALL VALUE	SMALL CORE	SMALL GROWTH	MEDIUM VALUE	MEDIUM CORE	MEDIUM GROWTH	LARGE VALUE	LARGE CORE	LARGE GROWTH
★ MUNI COMPOSITE									2.7 10
□ EQTY COMPOSITE									2.7 10
♥ DELAWARE							6.1 54		
♣ ALLIANCE									- 5.8 69
≈ LAZARD			12.2 21						
MEDIAN	18.7	16.2	4.2	15.0	12.6	2.4	6.8	- 1.3	- 4.2

VERMONT MUNICIPAL EMPLOYEES

EQUITY MANAGER SPECTRUM STYLE ANALYSIS - EQUITY ONLY RETURNS

YEAR ENDING 9/04

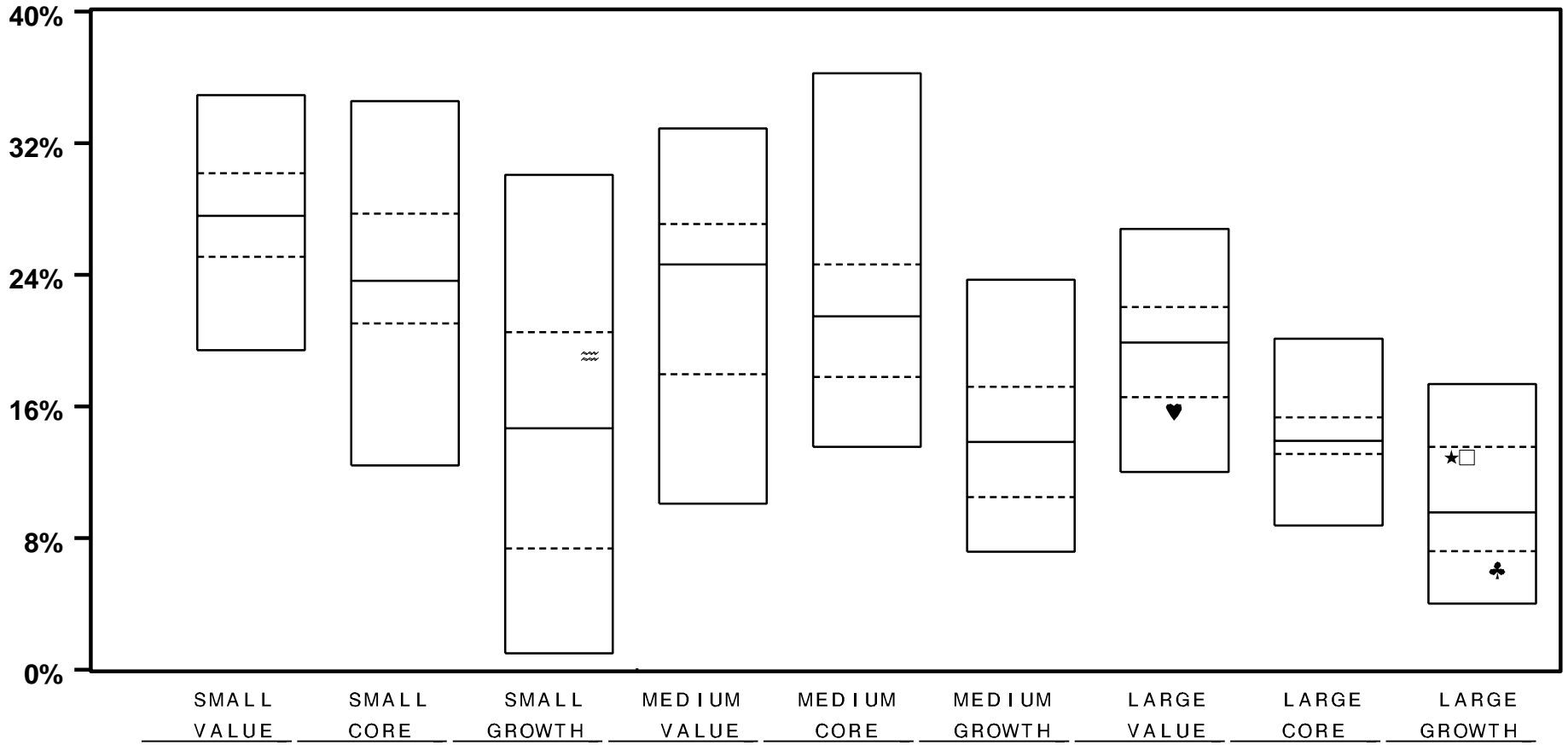

	SMALL VALUE	SMALL CORE	SMALL GROWTH	MEDIUM VALUE	MEDIUM CORE	MEDIUM GROWTH	LARGE VALUE	LARGE CORE	LARGE GROWTH
★ MUNI COMPOSITE									12.9 29
□ EQTY COMPOSITE									12.9 29
♥ DELAWARE							15.7 78		
♣ ALLIANCE									6.1 84
≈ LAZARD			19.1 30						
MEDIAN	27.6	23.6	14.7	24.6	21.5	13.8	19.9	13.9	9.6

VERMONT MUNICIPAL EMPLOYEES

EQUITY MANAGER SPECTRUM STYLE ANALYSIS - EQUITY ONLY RETURNS

YEAR ENDING 9/03

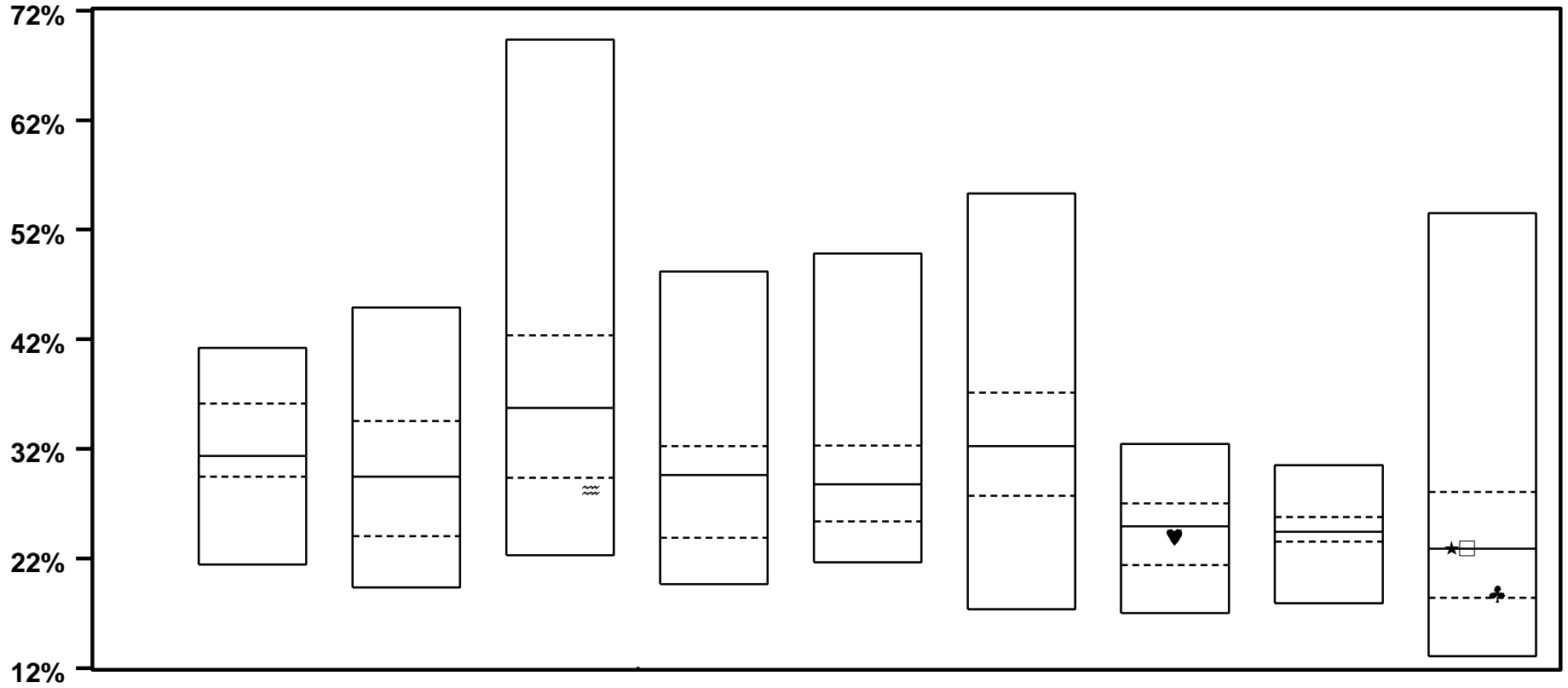

	SMALL VALUE	SMALL CORE	SMALL GROWTH	MEDIUM VALUE	MEDIUM CORE	MEDIUM GROWTH	LARGE VALUE	LARGE CORE	LARGE GROWTH
★ MUNI COMPOSITE									22.9 49
□ EQTY COMPOSITE									22.9 49
♥ DELAWARE							24.0 58		
♣ ALLIANCE									18.8 73
≈ LAZARD			28.2 78						
MEDIAN	31.4	29.5	35.8	29.6	28.8	32.2	24.9	24.4	22.9

VERMONT MUNICIPAL EMPLOYEES

EQUITY MANAGER SPECTRUM STYLE ANALYSIS - EQUITY ONLY RETURNS

YEAR ENDING 9/02

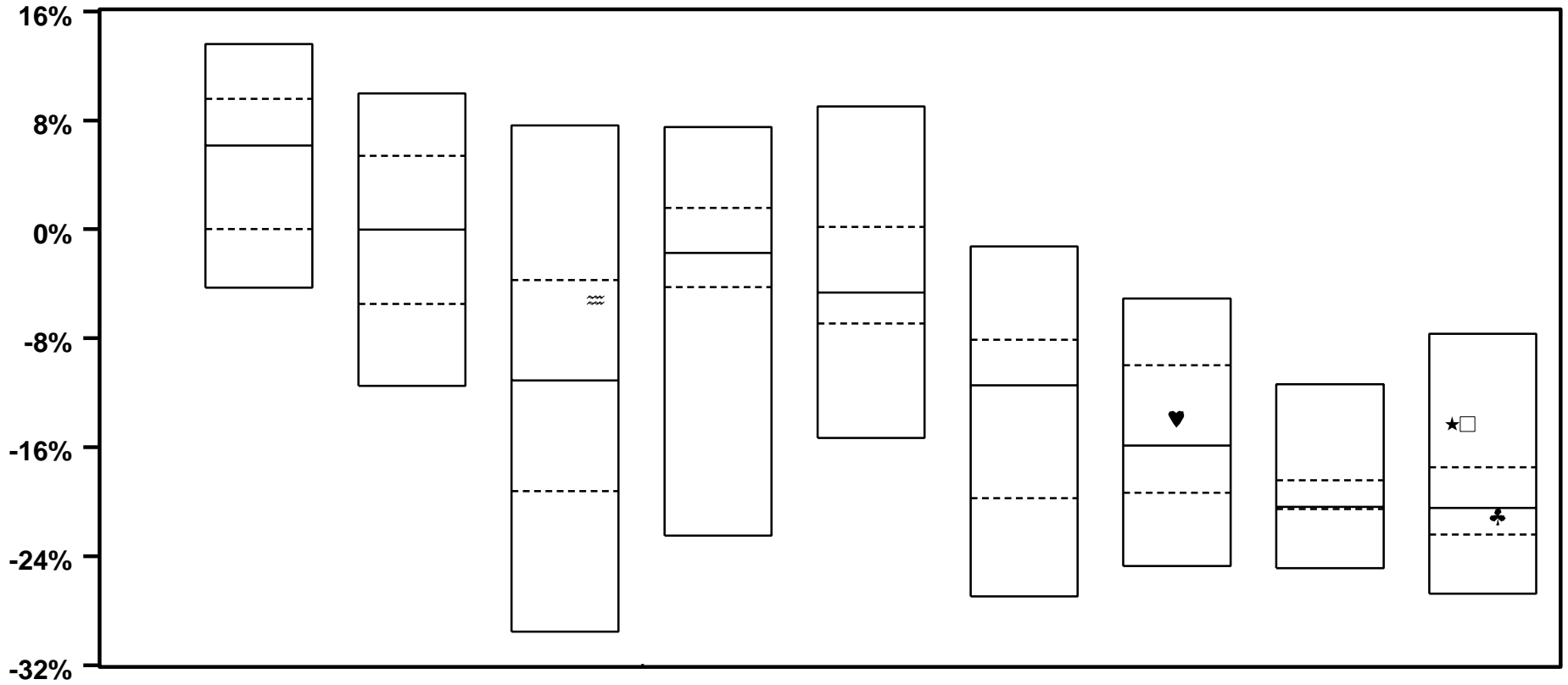

	SMALL VALUE	SMALL CORE	SMALL GROWTH	MEDIUM VALUE	MEDIUM CORE	MEDIUM GROWTH	LARGE VALUE	LARGE CORE	LARGE GROWTH
★ MUNI COMPOSITE									- 14.3 16
□ EQTY COMPOSITE									- 14.3 16
♥ DELAWARE							- 13.9 38		
♣ ALLIANCE									- 21.1 60
≡ LAZARD			- 5.2 29						
MEDIAN	6.2	0.0	- 11.1	- 1.7	- 4.6	- 11.5	- 15.9	- 20.4	- 20.4

VERMONT MUNICIPAL EMPLOYEES

EQUITY MANAGER SPECTRUM STYLE ANALYSIS - EQUITY ONLY RETURNS

YEAR ENDING 9/01

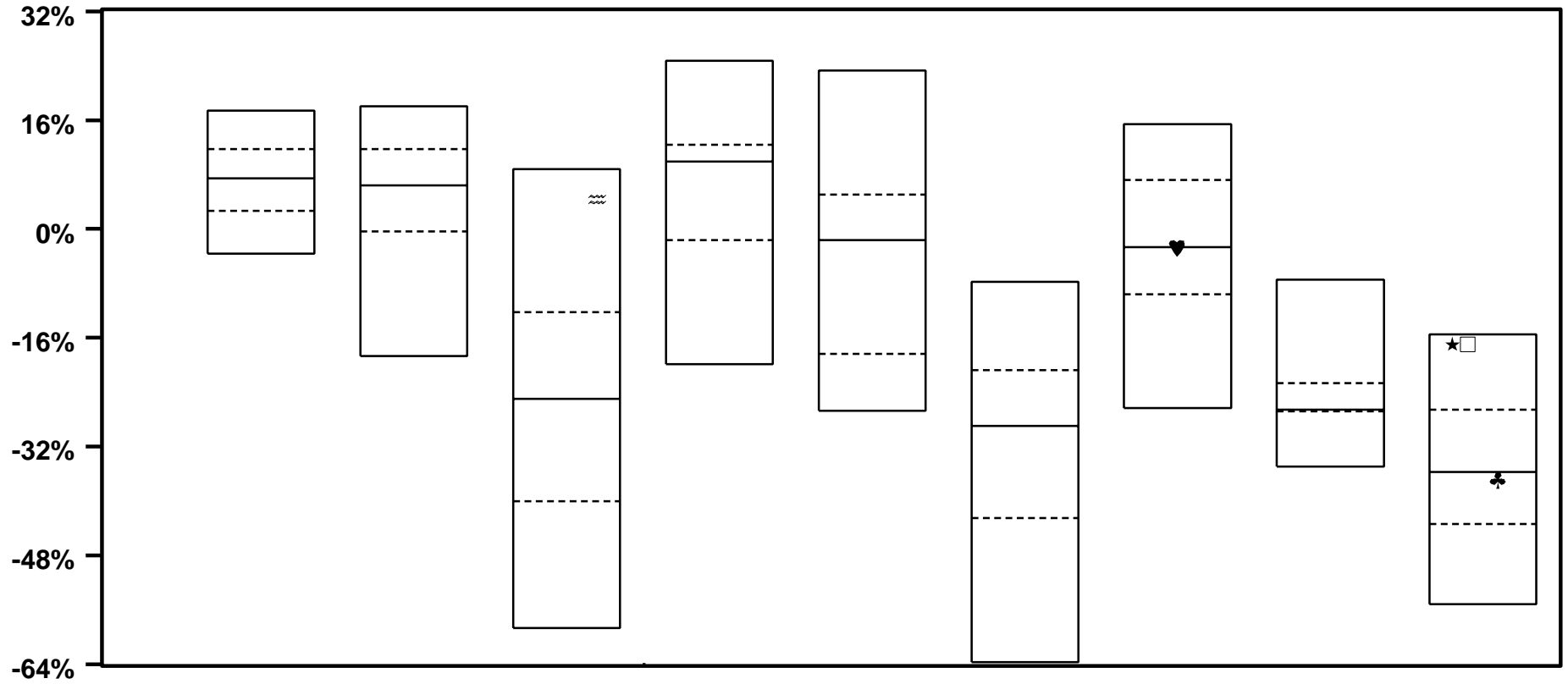

	SMALL VALUE	SMALL CORE	SMALL GROWTH	MEDIUM VALUE	MEDIUM CORE	MEDIUM GROWTH	LARGE VALUE	LARGE CORE	LARGE GROWTH
★ MUNI COMPOSITE									- 16.9 7
□ EQTY COMPOSITE									- 16.9 7
♥ DELAWARE							- 2.8 50		
♣ ALLIANCE									- 36.9 57
≡ LAZARD			4.4 10						
MEDIAN	7.4	6.4	- 25.0	9.9	- 1.6	- 29.0	- 2.7	- 26.6	- 35.7

VERMONT MUNICIPAL EMPLOYEES

EQUITY MANAGER SPECTRUM STYLE ANALYSIS - EQUITY ONLY RETURNS

YEAR ENDING 9/00

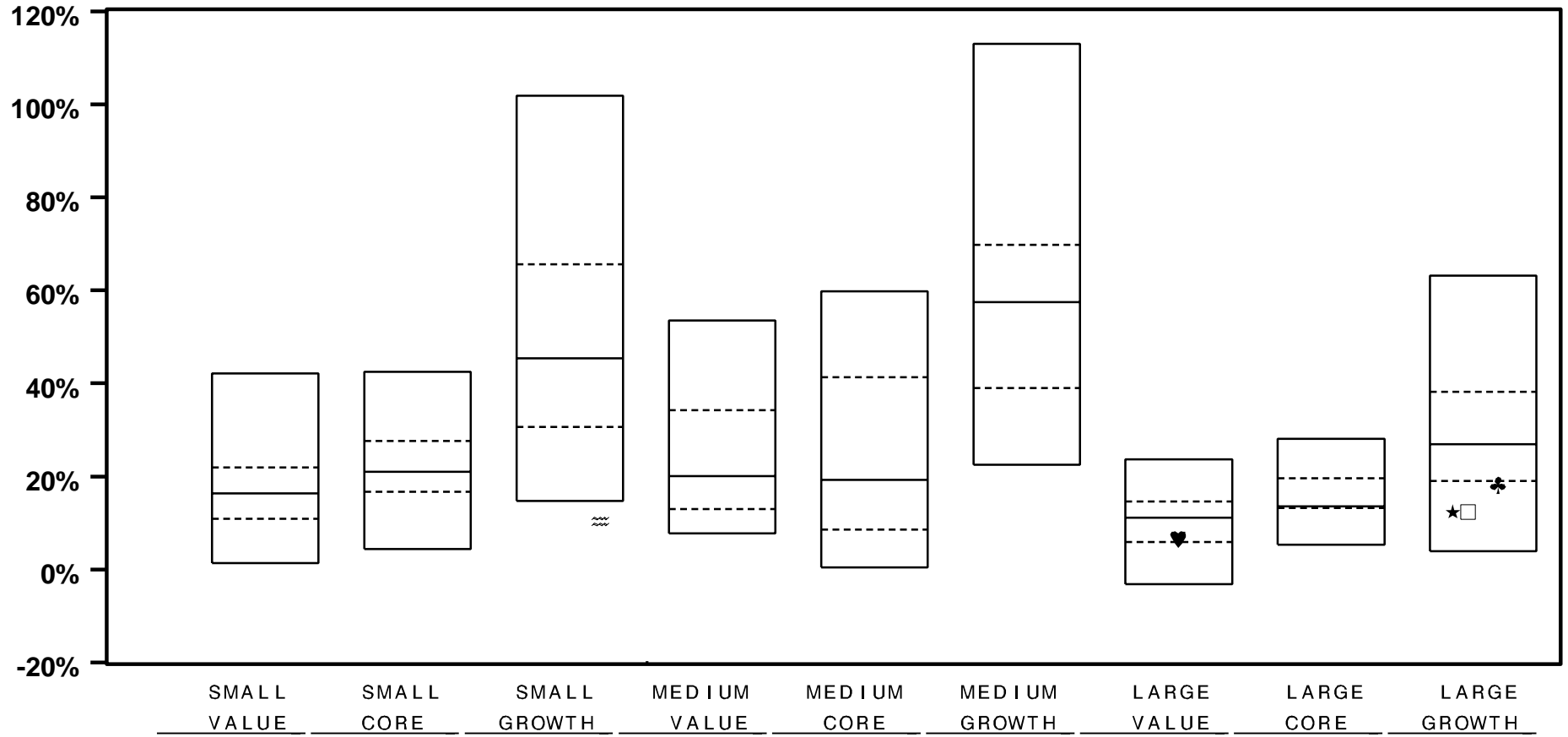

★ MUNI COMPOSITE										12.3	87
□ EQTY COMPOSITE										12.3	87
♥ DELAWARE							6.6	72			
♣ ALLIANCE										18.1	78
≈ LAZARD			10.4	97							
MEDIAN	16.4	21.0	45.4	20.1	19.3	57.5	11.1	13.5	27.0		

VERMONT MUNICIPAL EMPLOYEES

EQUITY STYLE SPECTRUM ANALYSIS

AS OF 9/05

(MOVEMENT OVER PAST TWO YEARS)

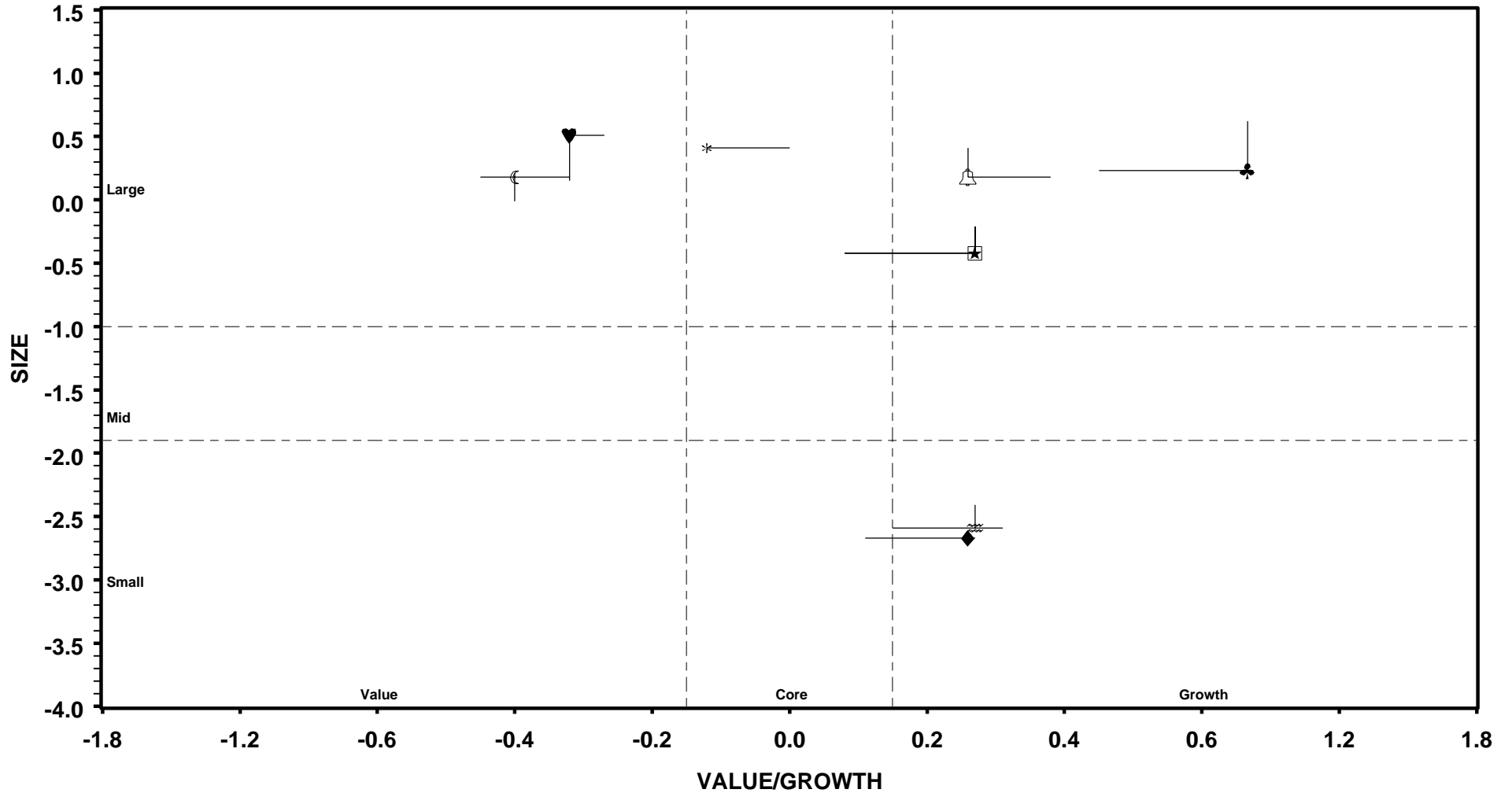

★ MUNI COMPOSITE □ EQTY COMPOSITE ♥ DELAWARE ♣ ALLIANCE ≡ LAZARD
 * S&P 500 Ⓒ R 1000(R) VALUE Ⓔ R 1000(R) GR

VERMONT MUNICIPAL EMPLOYEES

EQUITY STYLE SPECTRUM ANALYSIS

CURRENT DISTRIBUTION AND PORTFOLIO HISTORY

AS OF 9/05

MUNICIPAL SYSTEM COMPOSITE

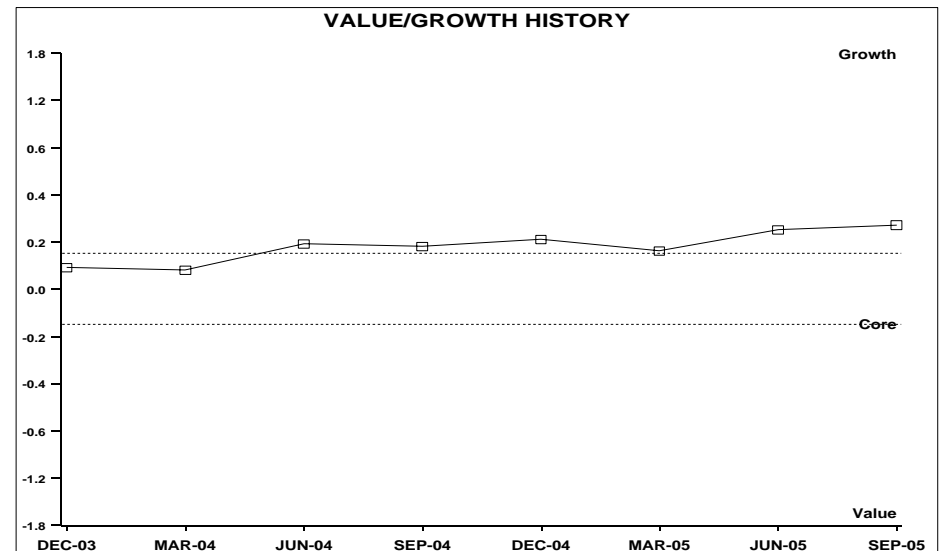
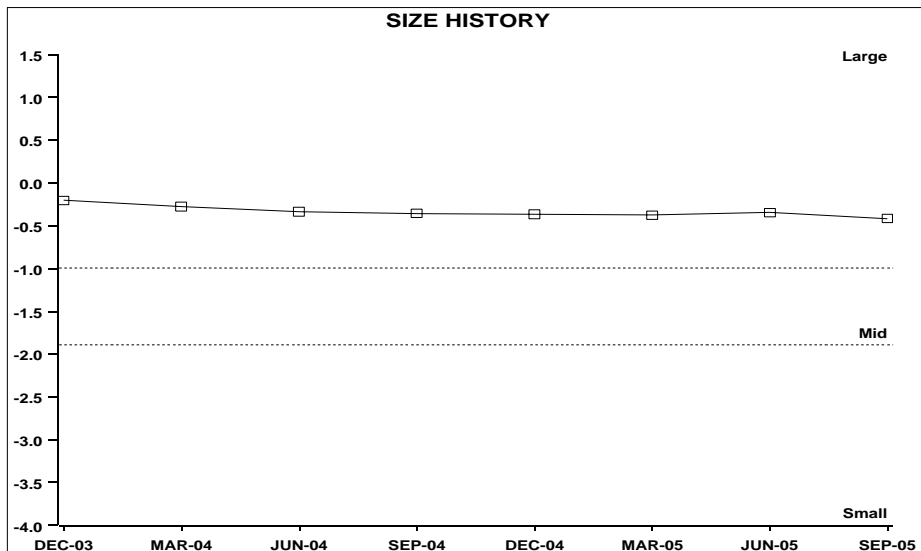
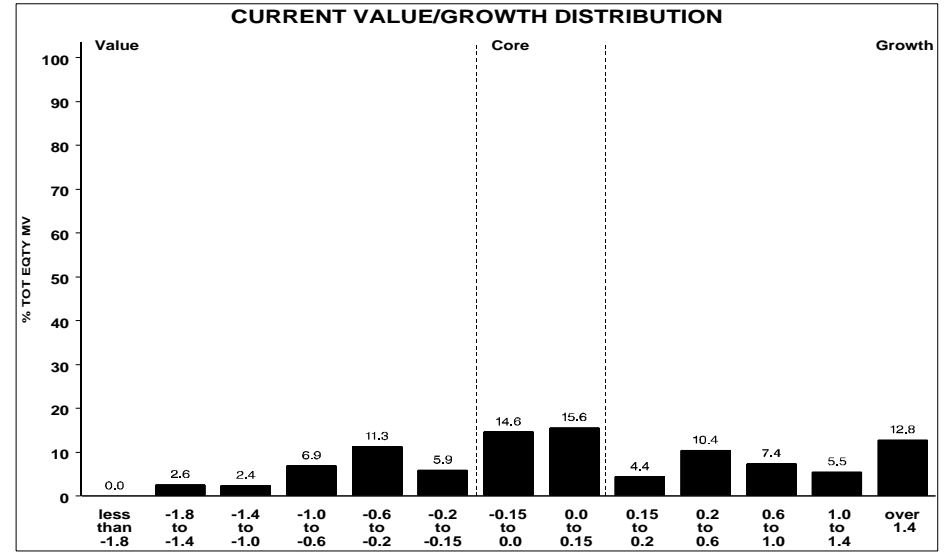
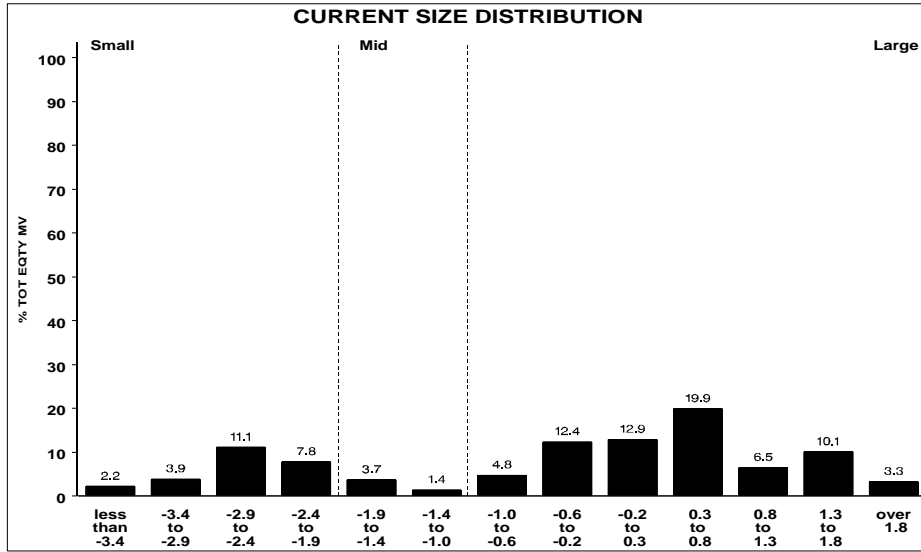

VERMONT MUNICIPAL EMPLOYEES

EQUITY STYLE SPECTRUM ANALYSIS

CURRENT DISTRIBUTION AND PORTFOLIO HISTORY

AS OF 9/05

DOMESTIC EQUITY COMPOSITE

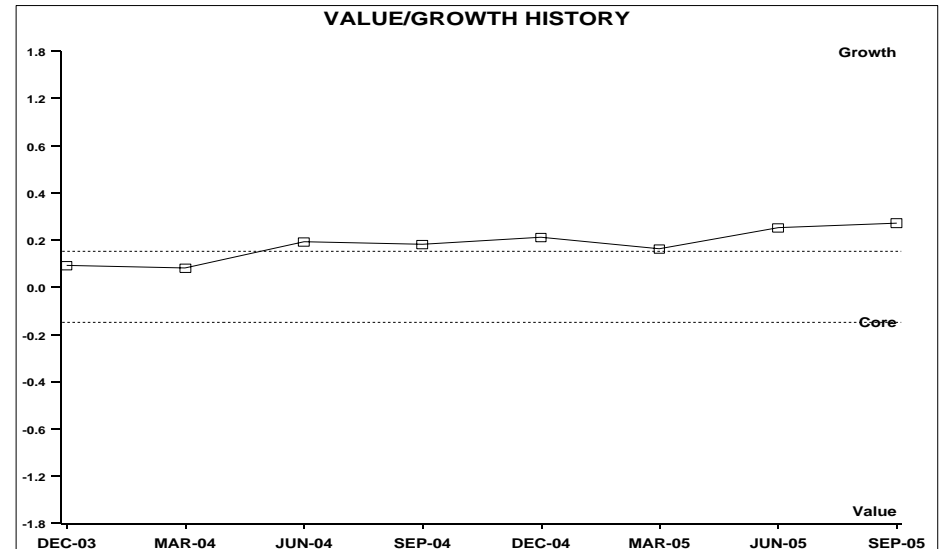
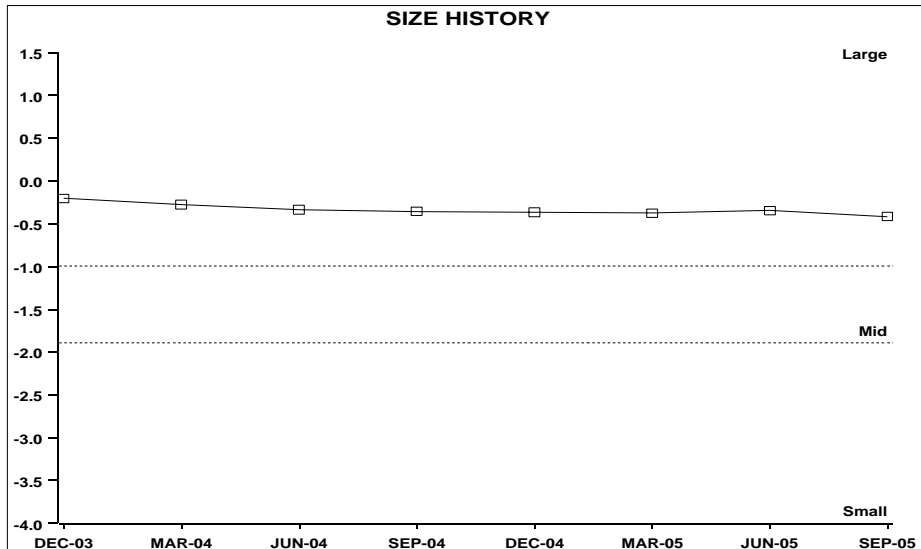
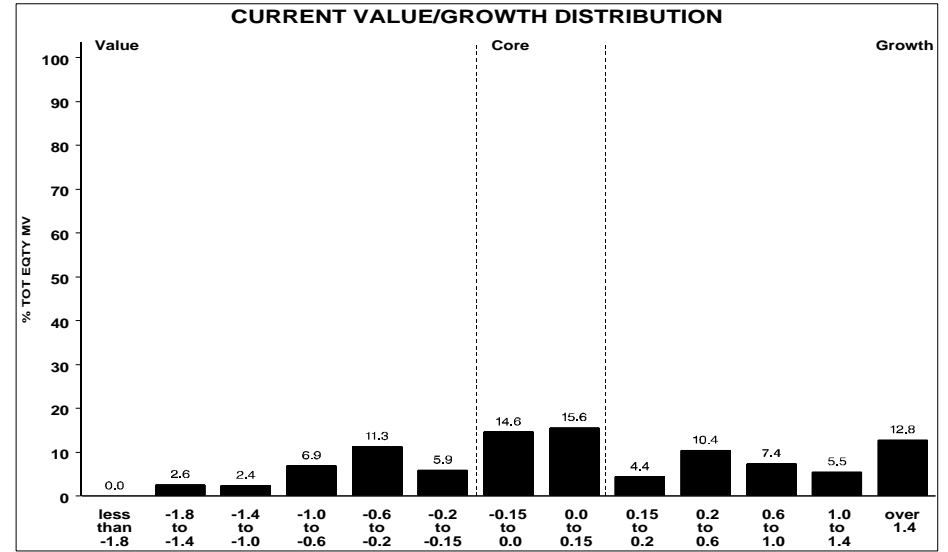
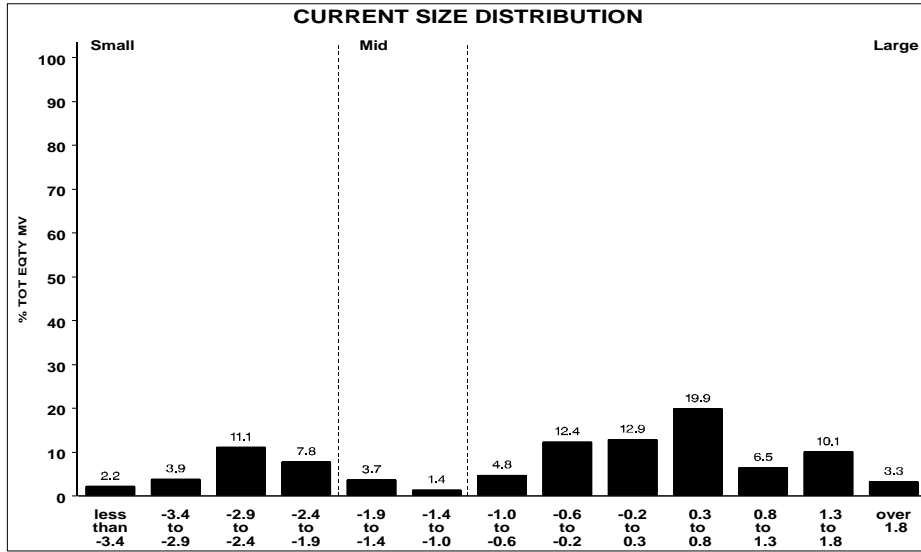

VERMONT MUNICIPAL EMPLOYEES

EQUITY STYLE SPECTRUM ANALYSIS

CURRENT DISTRIBUTION AND PORTFOLIO HISTORY

AS OF 9/05

DELAWARE

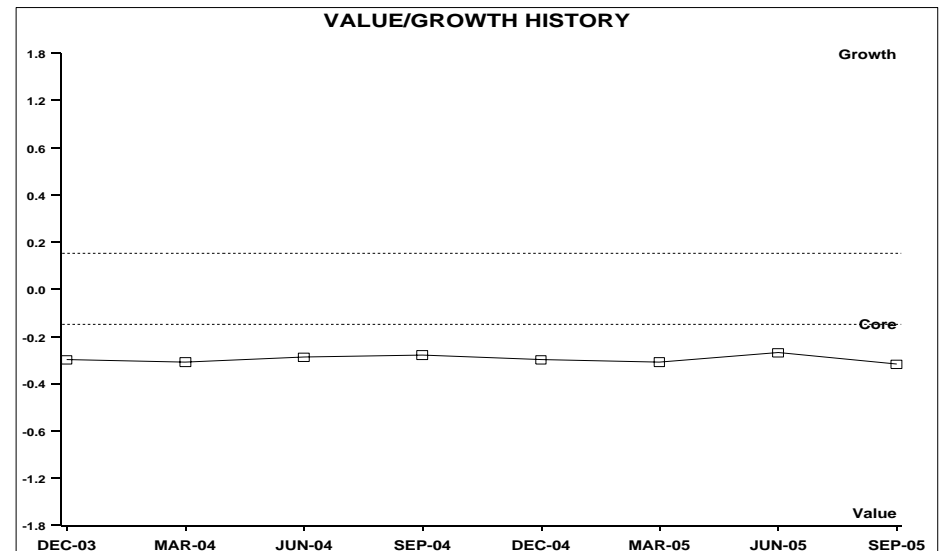
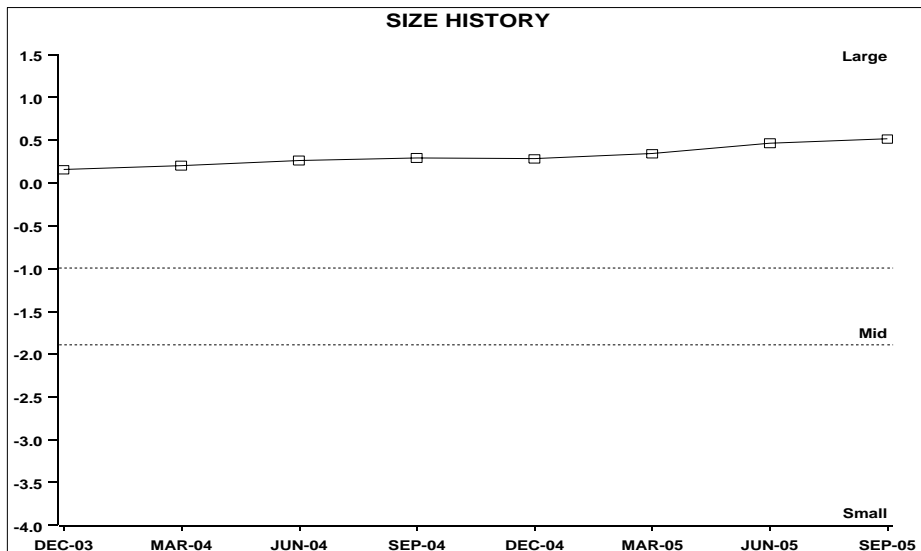
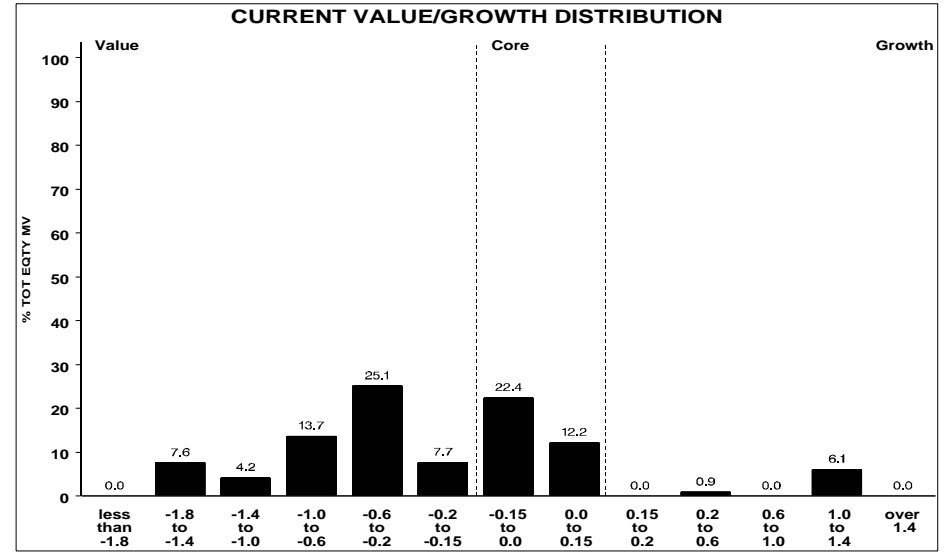
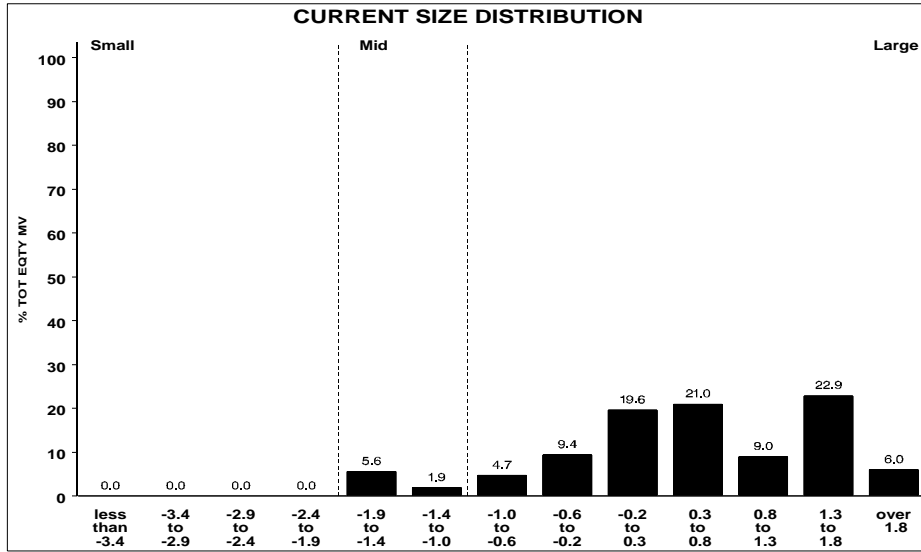

VERMONT MUNICIPAL EMPLOYEES

EQUITY STYLE SPECTRUM ANALYSIS

CURRENT DISTRIBUTION AND PORTFOLIO HISTORY

AS OF 9/05

ALLIANCE LARGE CAP GROWTH FUND

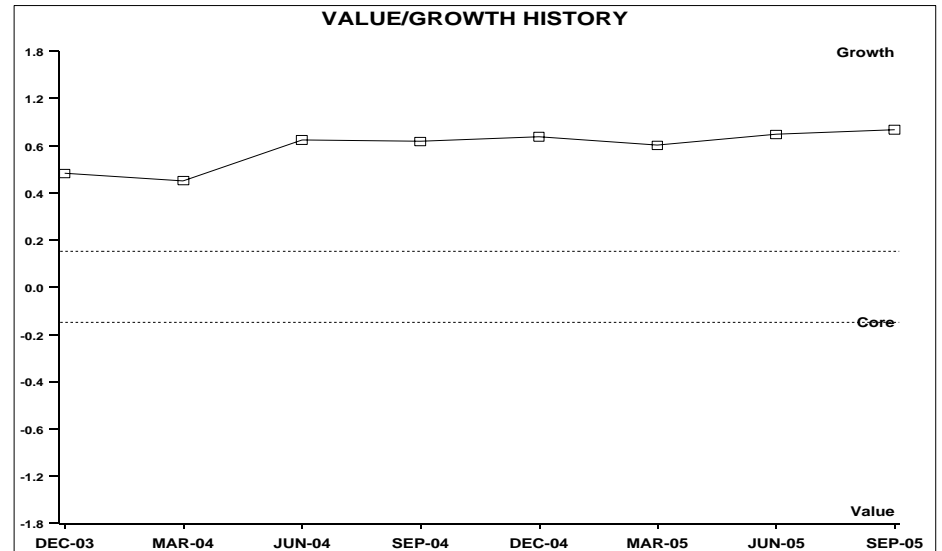
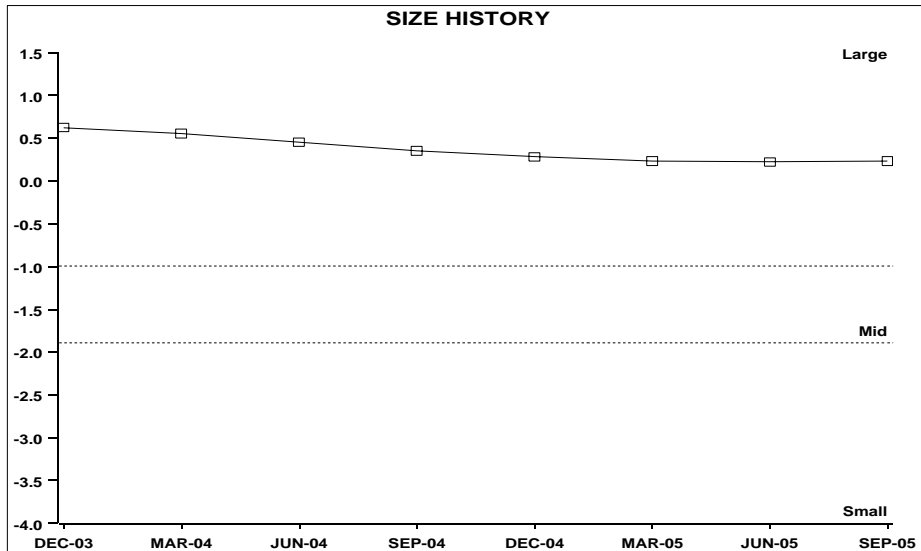
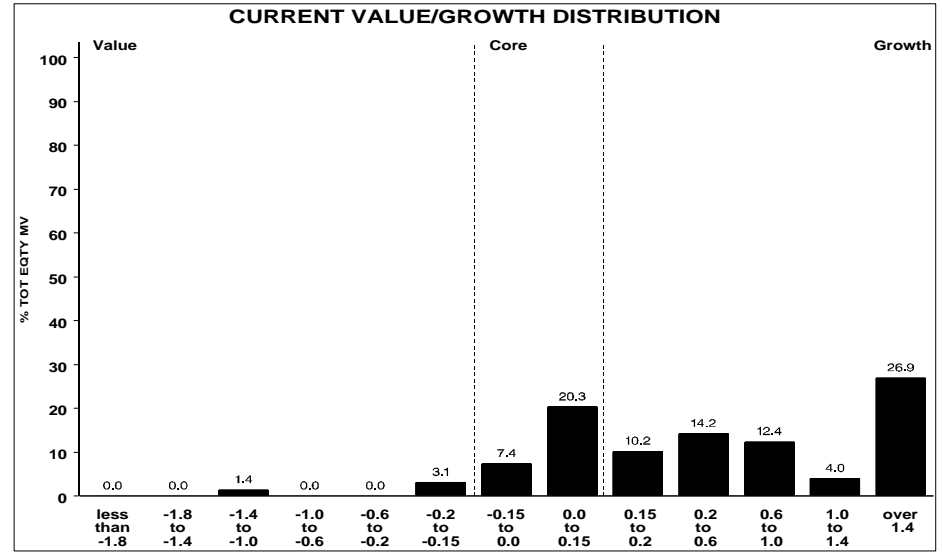
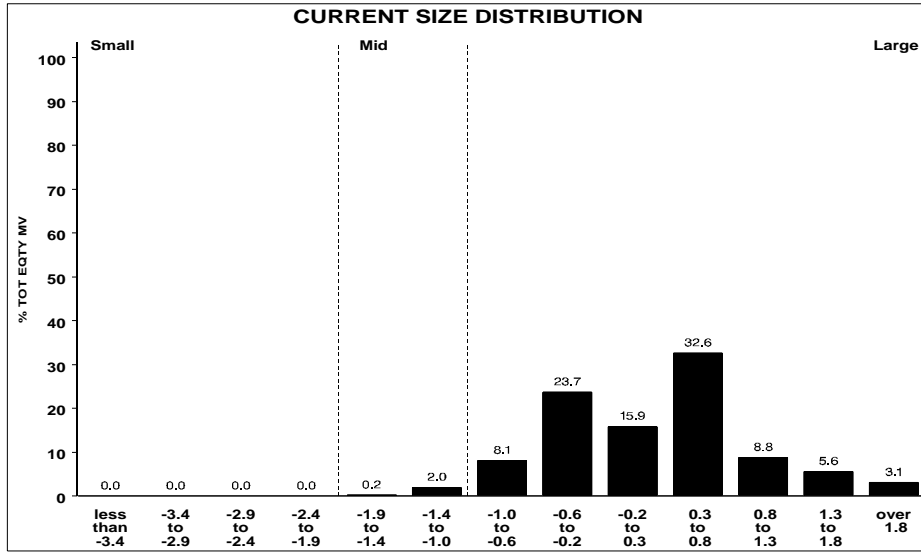

VERMONT MUNICIPAL EMPLOYEES

EQUITY STYLE SPECTRUM ANALYSIS

CURRENT DISTRIBUTION AND PORTFOLIO HISTORY

AS OF 9/05

LAZARD SMALL CAP FUND

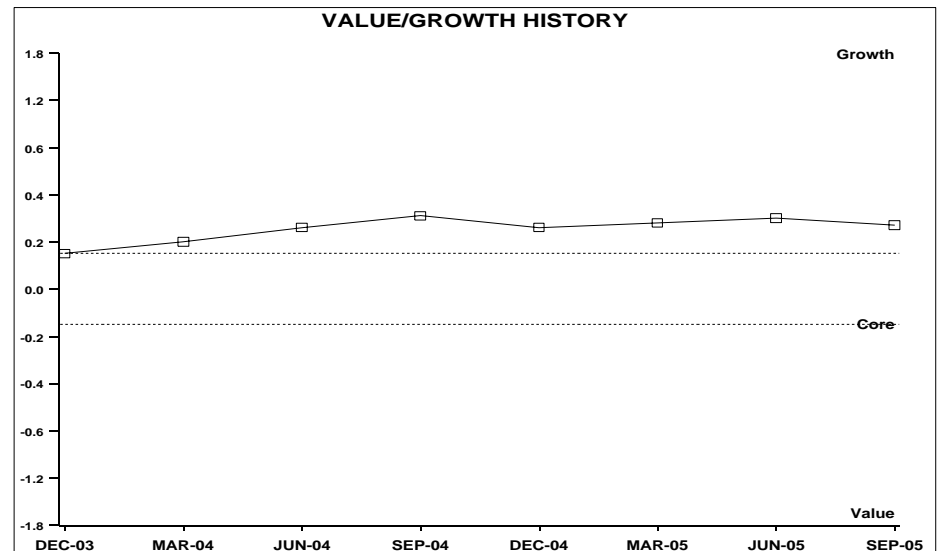
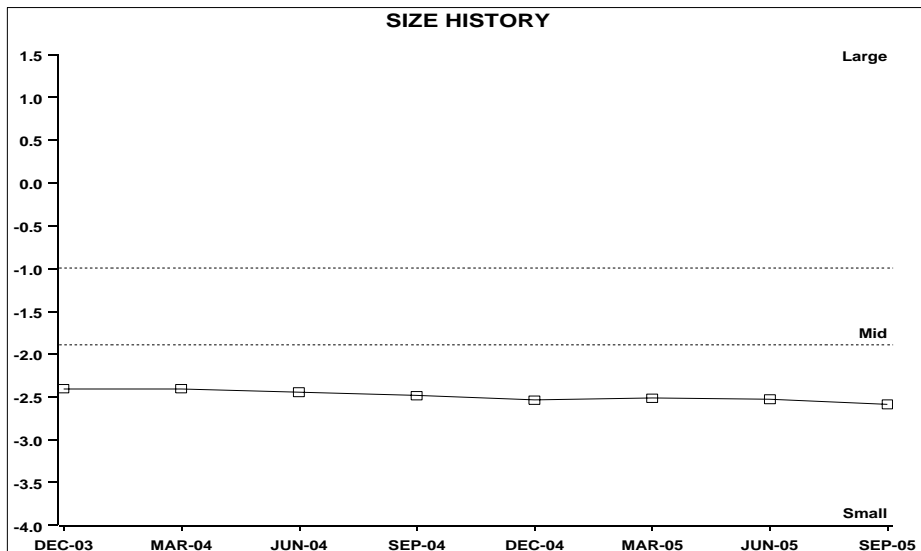
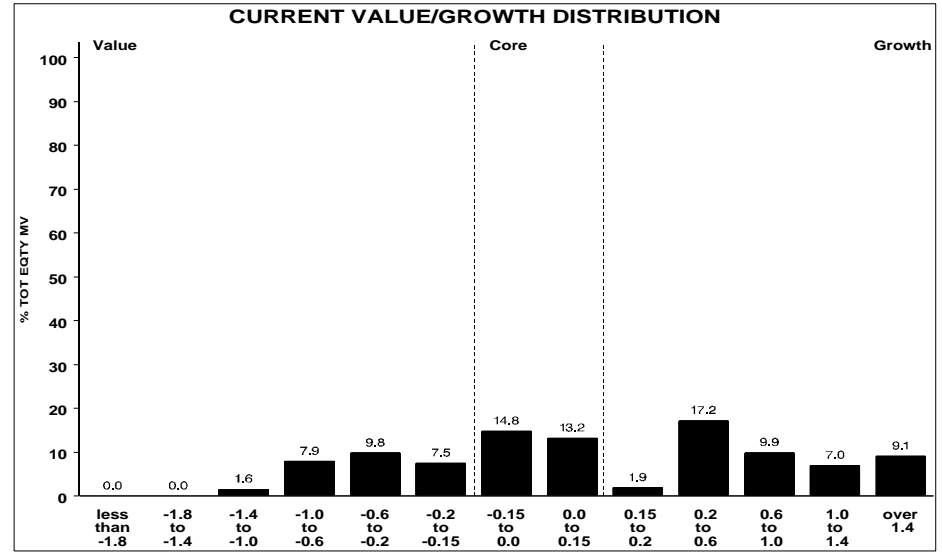
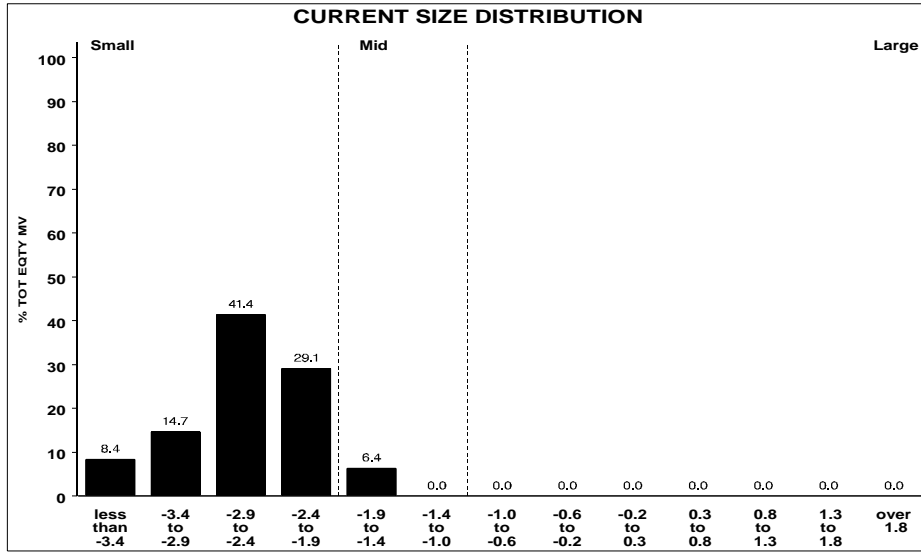

VERMONT MUNICIPAL EMPLOYEES

INT'L DEVELOPED MKT EQUITY MANAGER STYLE ANALYSIS - TOTAL RETURNS

QUARTER ENDING 9/05

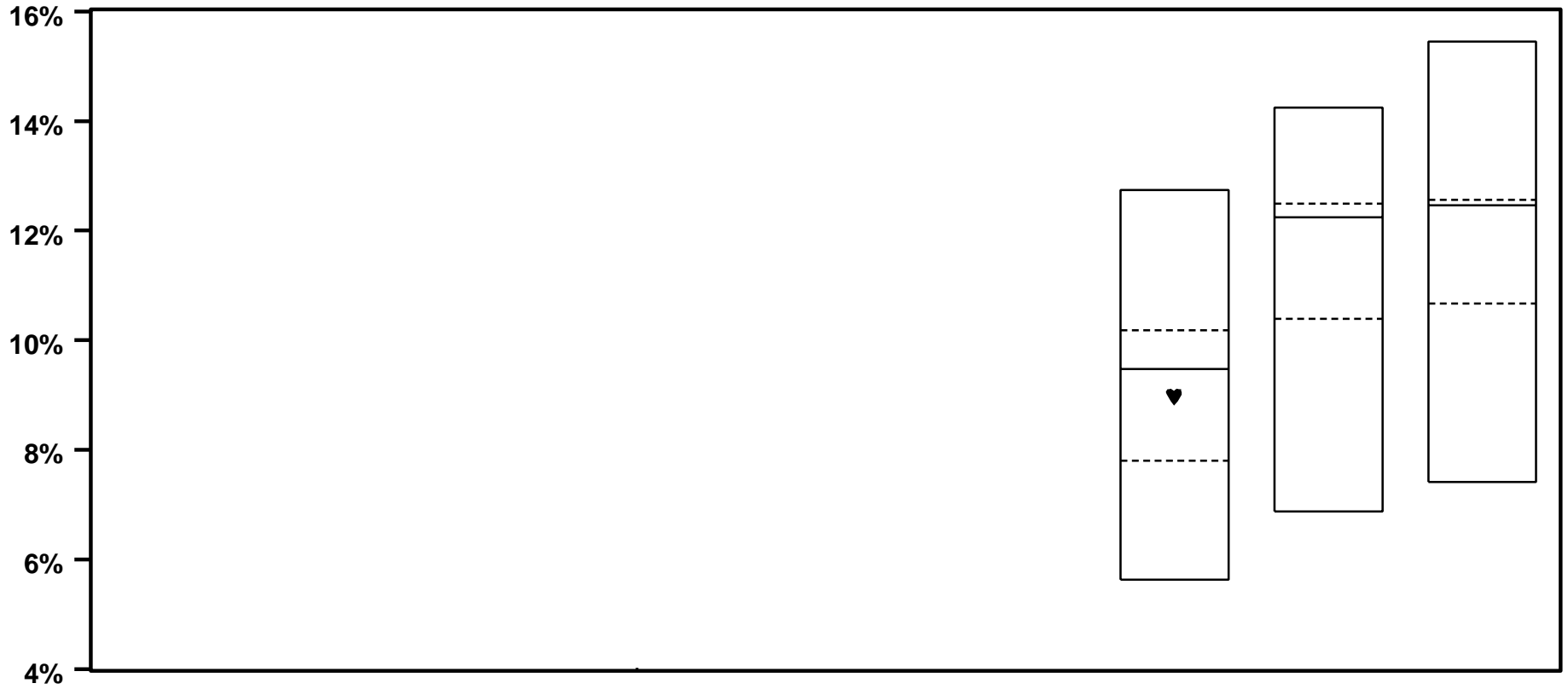

	LARGE VALUE	LARGE CORE	LARGE GROWTH
♥ UBS	9.0		
MEDIAN	9.5	12.2	12.5

VERMONT MUNICIPAL EMPLOYEES

INT'L DEVELOPED MKT EQUITY MANAGER STYLE ANALYSIS - TOTAL RETURNS

YEAR ENDING 9/05

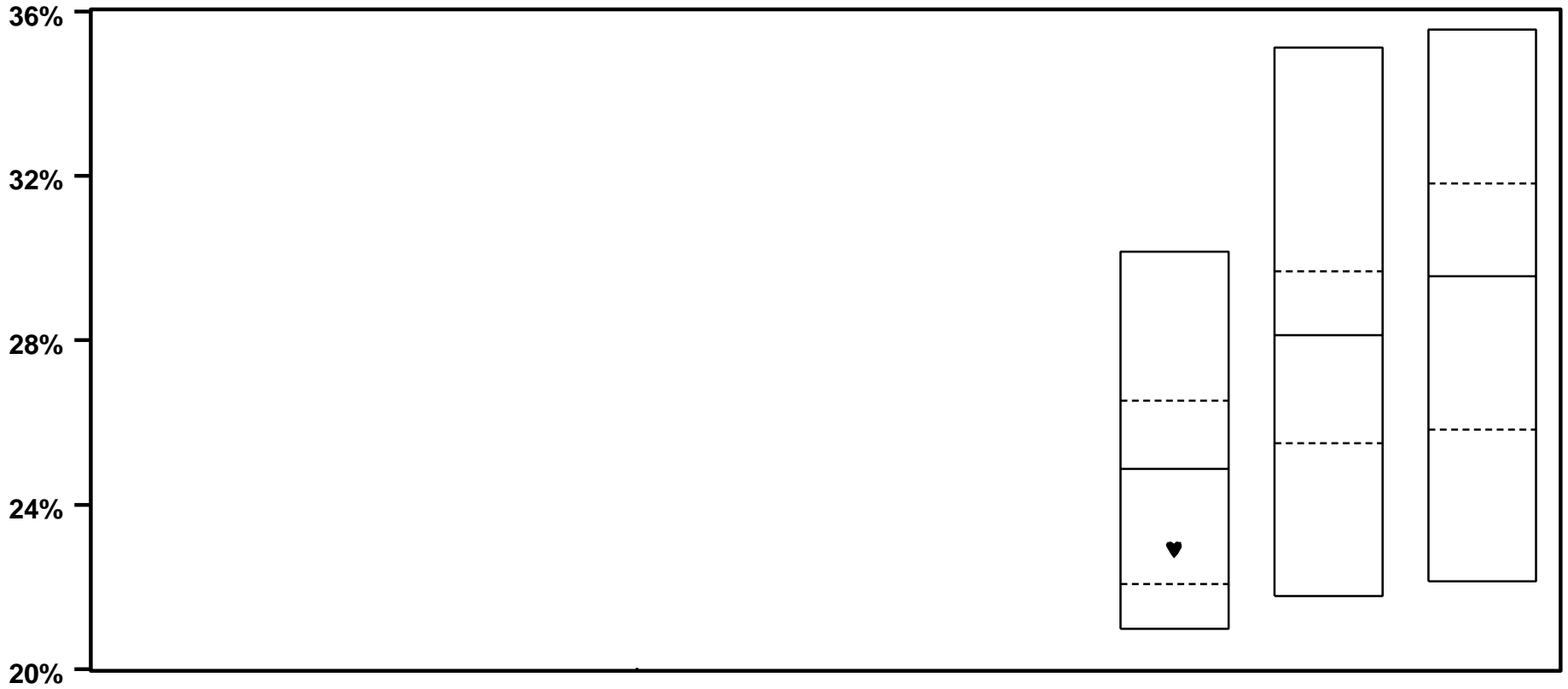

	LARGE VALUE	LARGE CORE	LARGE GROWTH
♥ UBS	22.9		
MEDIAN	24.9	28.1	29.6

VERMONT MUNICIPAL EMPLOYEES

INT'L DEVELOPED MKT EQUITY MANAGER STYLE ANALYSIS - TOTAL RETURNS

TWO YEARS ENDING 9/05

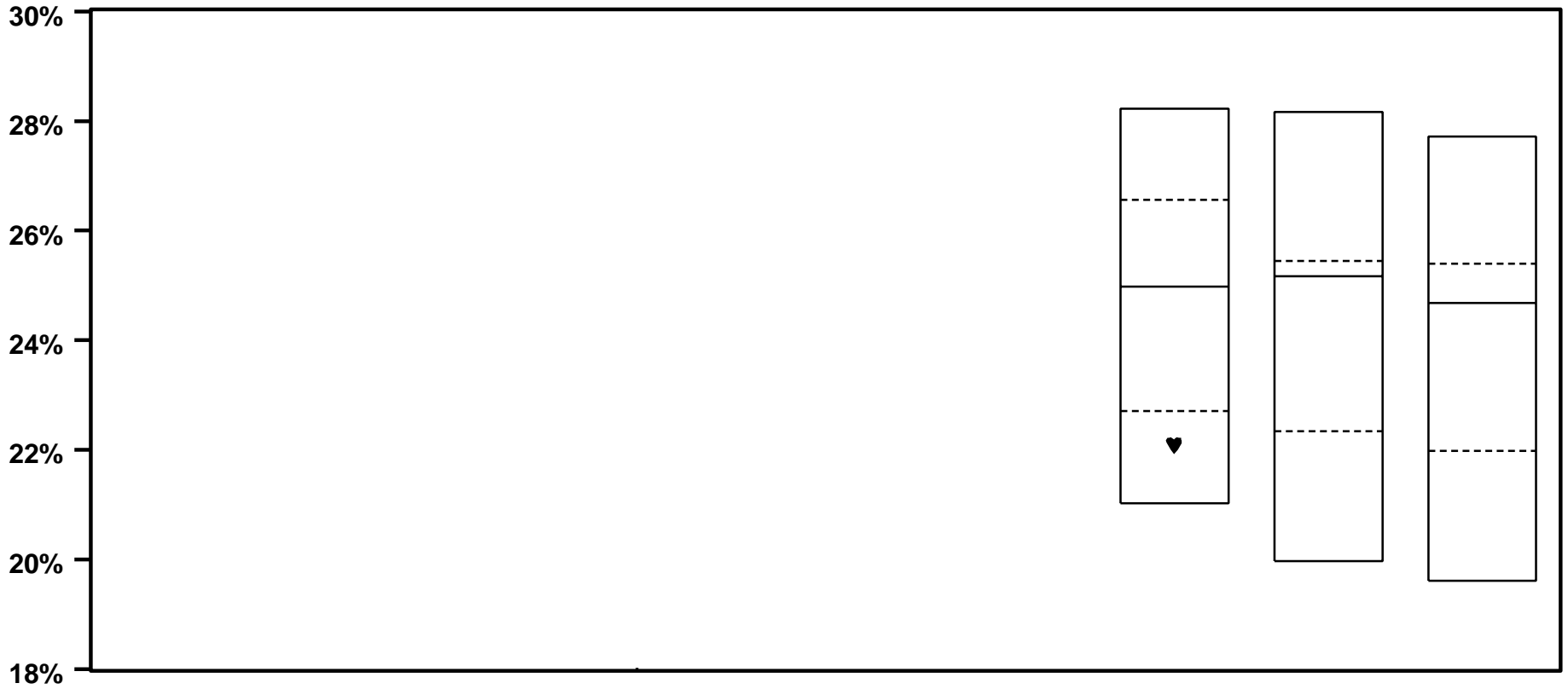

	LARGE VALUE	LARGE CORE	LARGE GROWTH
♥ UBS	22.1		
MEDIAN	25.0	25.2	24.7

VERMONT MUNICIPAL EMPLOYEES

INT'L DEVELOPED MKT EQUITY MANAGER STYLE ANALYSIS - TOTAL RETURNS

THREE YEARS ENDING 9/05

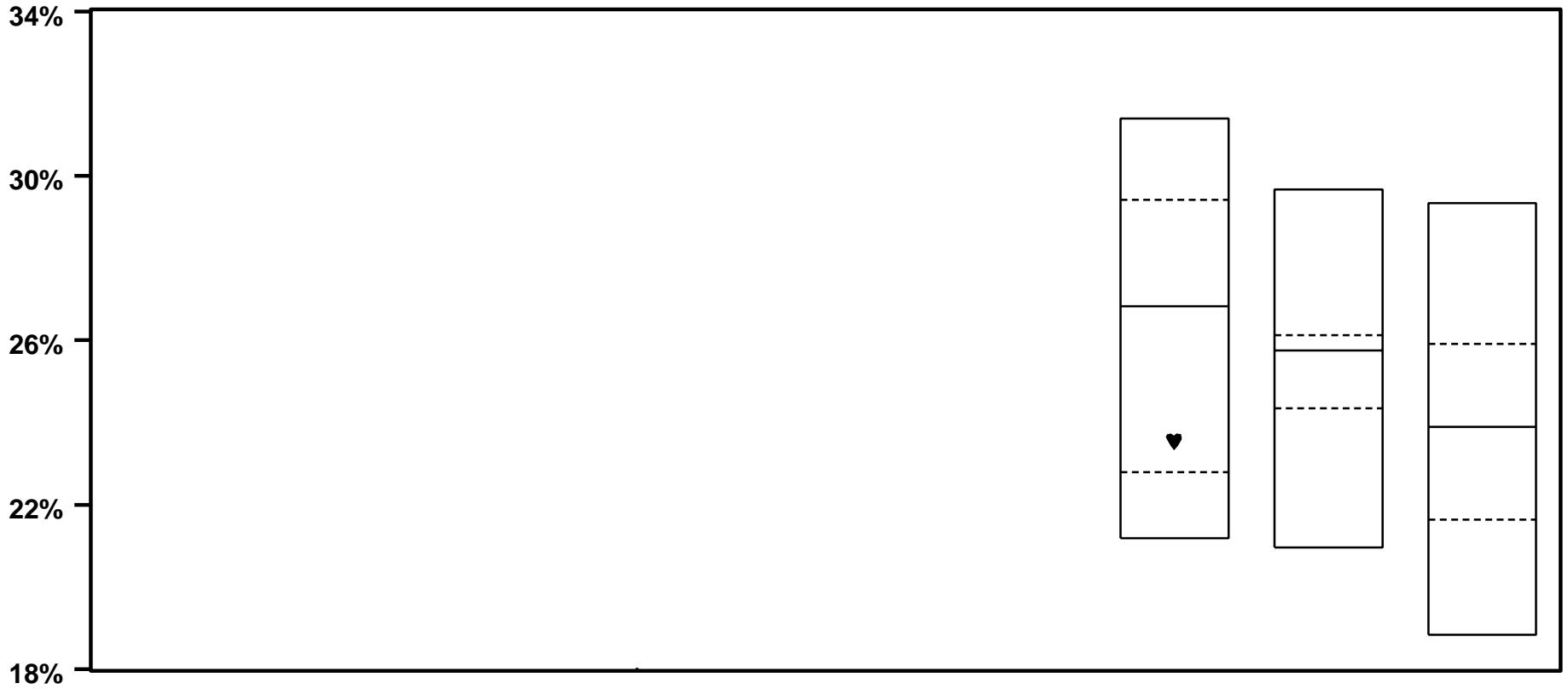

	LARGE VALUE	LARGE CORE	LARGE GROWTH
♥ UBS	23.5		
MEDIAN	26.8	25.8	23.9

VERMONT MUNICIPAL EMPLOYEES

INT'L DEVELOPED MKT EQUITY MANAGER STYLE ANALYSIS - TOTAL RETURNS

FOUR YEARS ENDING 9/05

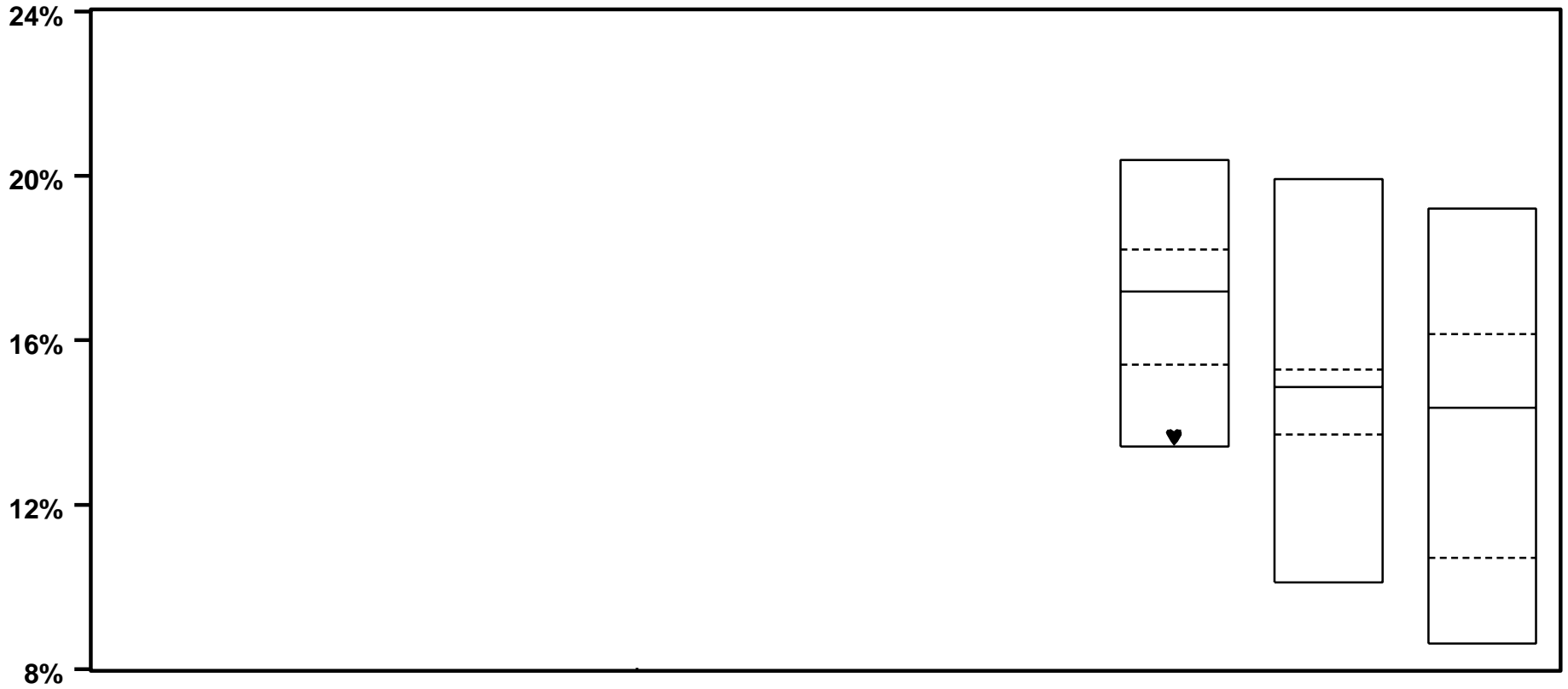

	LARGE VALUE	LARGE CORE	LARGE GROWTH
♥ UBS	13.6		
	92		
MEDIAN	17.2	14.9	14.4

VERMONT MUNICIPAL EMPLOYEES

INT'L DEVELOPED MKT EQUITY MANAGER STYLE ANALYSIS - TOTAL RETURNS

FIVE YEARS ENDING 9/05

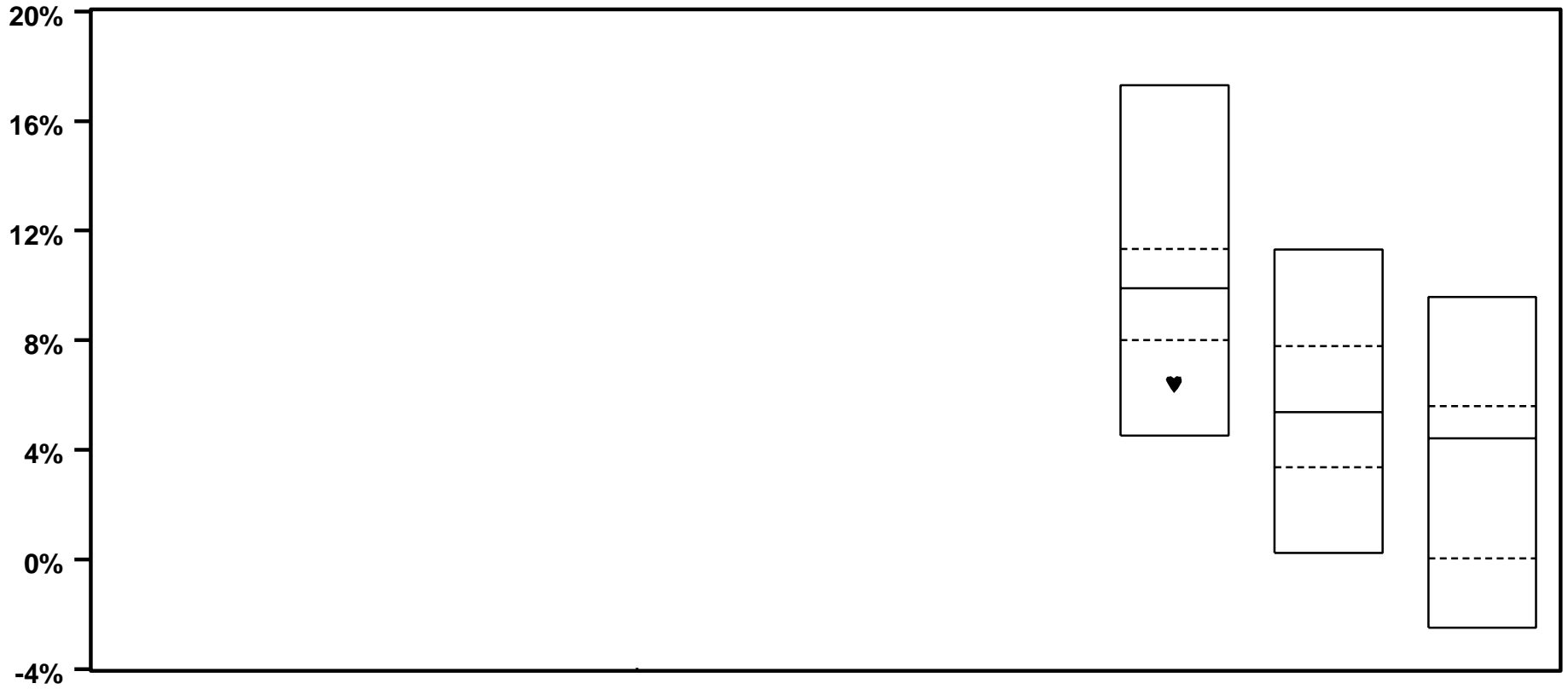

	LARGE VALUE	LARGE CORE	LARGE GROWTH
♥ UBS	6.4		
MEDIAN	9.9	5.4	4.4

VERMONT MUNICIPAL EMPLOYEES

INT'L DEVELOPED MKT EQUITY MANAGER STYLE ANALYSIS - TOTAL RETURNS

YEAR ENDING 9/04

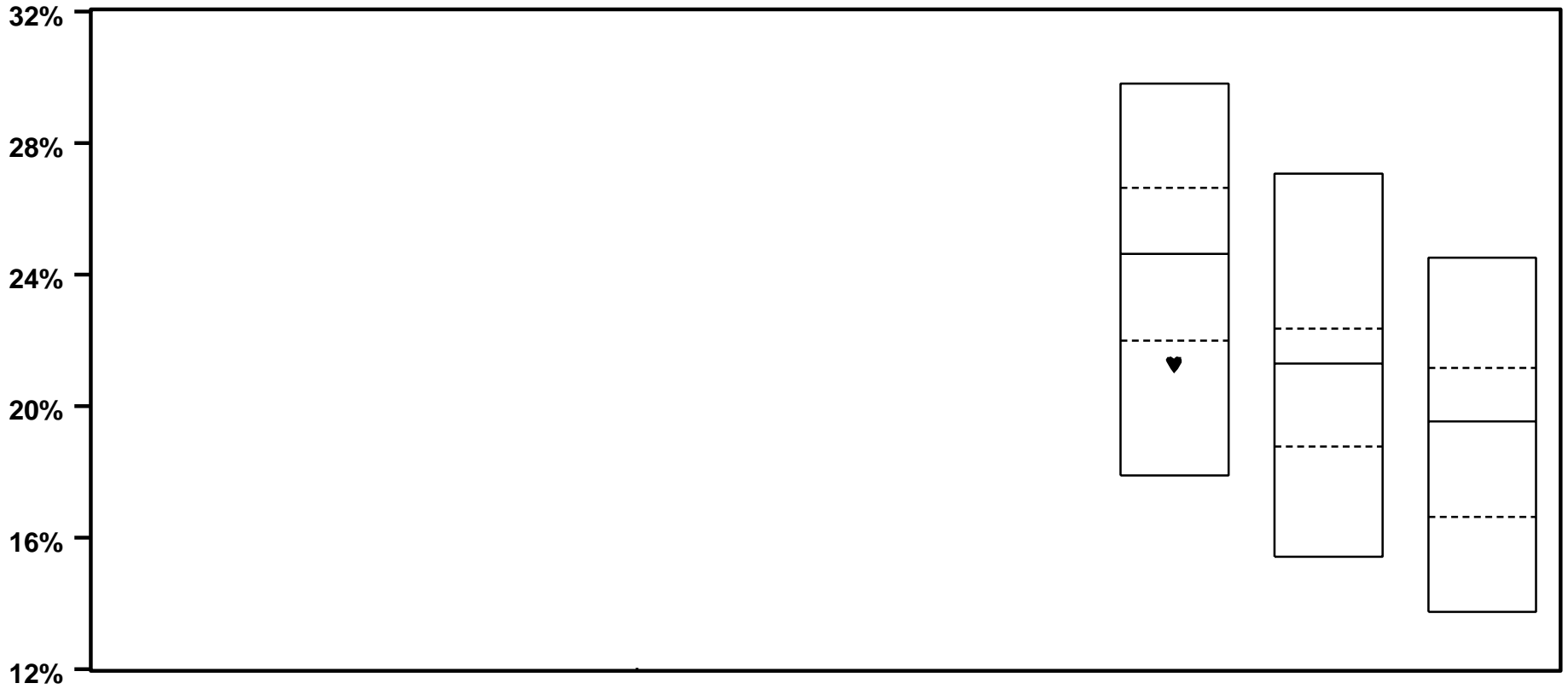

	LARGE VALUE	LARGE CORE	LARGE GROWTH
♥ UBS	21.3		
MEDIAN	24.6	21.3	19.5

VERMONT MUNICIPAL EMPLOYEES

INT'L DEVELOPED MKT EQUITY MANAGER STYLE ANALYSIS - TOTAL RETURNS

YEAR ENDING 9/03

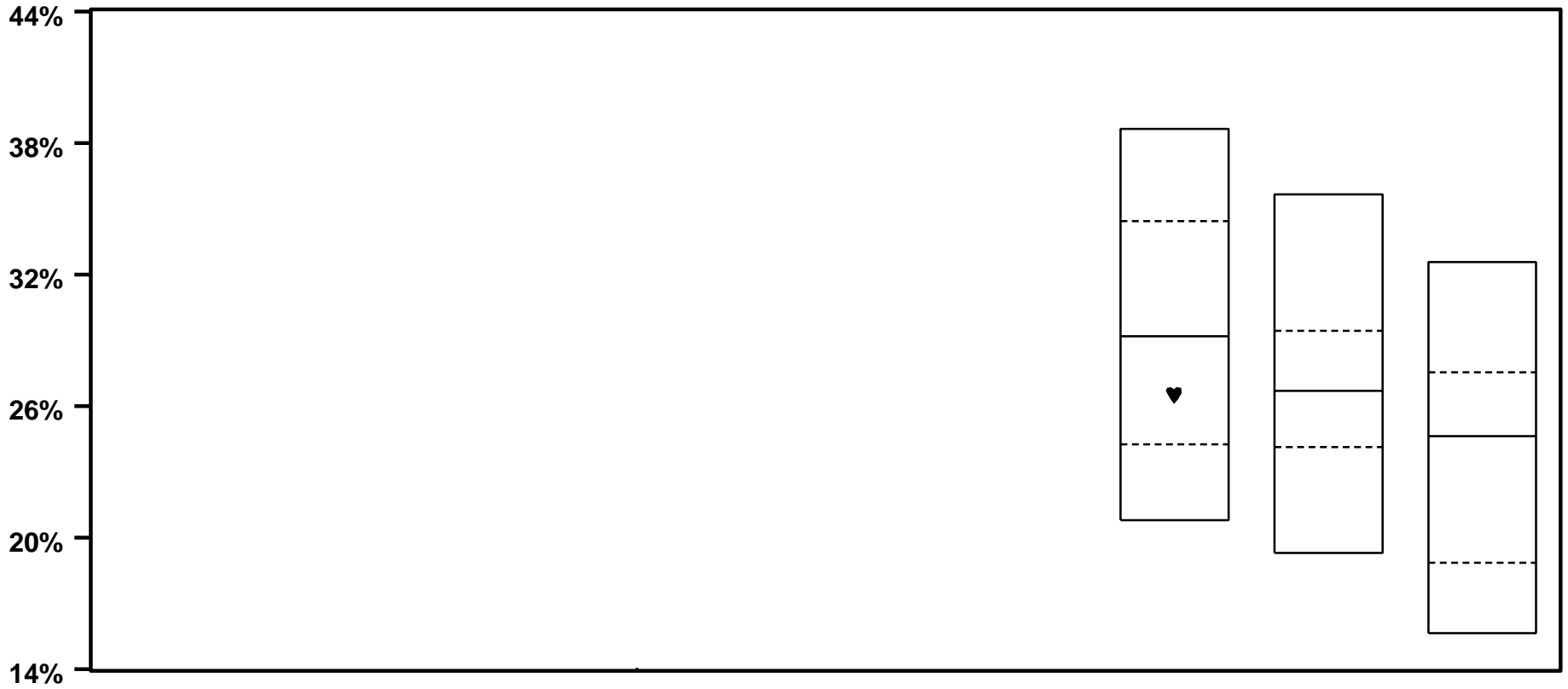

	LARGE VALUE	LARGE CORE	LARGE GROWTH
♥ UBS	26.5		
MEDIAN	29.2	26.7	24.6

VERMONT MUNICIPAL EMPLOYEES

INT'L DEVELOPED MKT EQUITY MANAGER STYLE ANALYSIS - TOTAL RETURNS

YEAR ENDING 9/02



	LARGE VALUE	LARGE CORE	LARGE GROWTH
♥ UBS	- 11.5	69	
MEDIAN	- 9.7	- 11.7	- 13.7

VERMONT MUNICIPAL EMPLOYEES

INT'L DEVELOPED MKT EQUITY MANAGER STYLE ANALYSIS - TOTAL RETURNS

YEAR ENDING 9/01



	LARGE VALUE	LARGE CORE	LARGE GROWTH
♥ UBS	- 18.2	58	
MEDIAN	- 17.0	- 26.2	- 30.9

VERMONT MUNICIPAL EMPLOYEES

INT'L DEVELOPED MKT EQUITY MANAGER STYLE ANALYSIS - TOTAL RETURNS

YEAR ENDING 9/00



	LARGE VALUE	LARGE CORE	LARGE GROWTH
♥ UBS	3.4		
MEDIAN	8.1	13.1	16.1

VERMONT MUNICIPAL EMPLOYEES

BOND SUMMARY STATISTICS

QUARTER ENDING 9/05

MUNICIPAL SYSTEM COMPOSITE

	<u>PORTFOLIO</u>	<u>LB AGGREGATE</u>
TOTAL NUMBER OF SECURITIES	364	
TOTAL MARKET VALUE	\$ 72,364,015	
CURRENT COUPON	5.20	5.21
YIELD TO MATURITY	4.90	4.94
AVERAGE MATURITY	6.48	7.00
DURATION	4.37	4.44
QUALITY	9.08	9.54

YIELD TO MATURITY	% HELD
0.0 - 5.0	57.2
5.0 - 7.0	33.0
7.0 - 9.0	4.7
9.0 - 11.0	0.0
11.0 - 13.0	0.0
13.0+	0.0
UNCLASSIFIED	5.0

AVERAGE MATURITY	% HELD
0.0 - 1.0	7.3
1.0 - 3.0	26.7
3.0 - 5.0	22.3
5.0 - 10.0	28.9
10.0 - 20.0	0.6
20.0+	9.2
UNCLASSIFIED	5.0

DURATION YEARS	% HELD
0.0 - 1.0	7.8
1.0 - 3.0	30.4
3.0 - 4.0	20.4
4.0 - 6.0	13.6
6.0 - 8.0	13.3
8.0+	9.5
UNCLASSIFIED	5.0

QUALITY	% HELD
GOVT (10)	72.6
Aaa (10)	1.3
Aa (9)	1.6
A (8)	1.9
Baa (7)	4.7
Below Baa (6 - 1)	14.9
Other	3.1

COUPON	% HELD
0.0 - 5.0	47.4
5.0 - 7.0	36.9
7.0 - 9.0	11.8
9.0 - 11.0	3.5
11.0 - 13.0	0.3
13.0+	0.0
UNCLASSIFIED	0.0

VERMONT MUNICIPAL EMPLOYEES

BOND SUMMARY STATISTICS

QUARTER ENDING 9/05

SEIX CORE

	PORTFOLIO	LB AGGREGATE
TOTAL NUMBER OF SECURITIES	116	
TOTAL MARKET VALUE	\$ 61,492,445	
CURRENT COUPON	4.65	5.21
YIELD TO MATURITY	4.58	4.94
AVERAGE MATURITY	6.47	7.00
DURATION	4.40	4.44
QUALITY	9.76	9.54

YIELD TO MATURITY	% HELD
0.0 - 5.0	66.9
5.0 - 7.0	26.5
7.0 - 9.0	0.7
9.0 - 11.0	0.0
11.0 - 13.0	0.0
13.0+	0.0
UNCLASSIFIED	5.9

AVERAGE MATURITY	% HELD
0.0 - 1.0	7.4
1.0 - 3.0	27.6
3.0 - 5.0	21.9
5.0 - 10.0	27.4
10.0 - 20.0	0.3
20.0+	9.5
UNCLASSIFIED	5.9

DURATION YEARS	% HELD
0.0 - 1.0	8.3
1.0 - 3.0	30.8
3.0 - 4.0	20.7
4.0 - 6.0	10.0
6.0 - 8.0	14.7
8.0+	9.5
UNCLASSIFIED	5.9

QUALITY	% HELD
GOVT (10)	85.4
Aaa (10)	1.6
Aa (9)	1.8
A (8)	2.2
Baa (7)	4.4
Below Baa (6 - 1)	1.0
Other	3.6

COUPON	% HELD
0.0 - 5.0	55.7
5.0 - 7.0	40.5
7.0 - 9.0	3.5
9.0 - 11.0	0.4
11.0 - 13.0	0.0
13.0+	0.0
UNCLASSIFIED	0.0

VERMONT MUNICIPAL EMPLOYEES

BOND SUMMARY STATISTICS

QUARTER ENDING 9/05

SEIX HIGH YIELD

	PORTFOLIO	CITI BB&B ALL
TOTAL NUMBER OF SECURITIES	248	
TOTAL MARKET VALUE	\$ 10,871,570	
CURRENT COUPON	8.29	
YIELD TO MATURITY	6.54	
AVERAGE MATURITY	6.56	
DURATION	4.21	
QUALITY	5.51	

YIELD TO MATURITY	% HELD
0.0 - 5.0	2.3
5.0 - 7.0	69.7
7.0 - 9.0	27.7
9.0 - 11.0	0.2
11.0 - 13.0	0.0
13.0+	0.0
UNCLASSIFIED	0.0

AVERAGE MATURITY	% HELD
0.0 - 1.0	6.5
1.0 - 3.0	21.7
3.0 - 5.0	24.8
5.0 - 10.0	37.5
10.0 - 20.0	2.6
20.0+	7.0
UNCLASSIFIED	0.0

DURATION YEARS	% HELD
0.0 - 1.0	5.3
1.0 - 3.0	28.1
3.0 - 4.0	18.6
4.0 - 6.0	33.6
6.0 - 8.0	5.2
8.0+	9.2
UNCLASSIFIED	0.0

QUALITY	% HELD
GOVT (10)	0.0
Aaa (10)	0.0
Aa (9)	0.0
A (8)	0.0
Baa (7)	6.4
Below Baa (6 - 1)	93.6
Other	0.0

COUPON	% HELD
0.0 - 5.0	0.4
5.0 - 7.0	16.9
7.0 - 9.0	58.9
9.0 - 11.0	21.5
11.0 - 13.0	2.3
13.0+	0.0
UNCLASSIFIED	0.0

VERMONT MUNICIPAL EMPLOYEES

BOND PORTFOLIO CHARACTERISTICS

PERIODS ENDING 9/05

AVERAGE MATURITY (YRS)

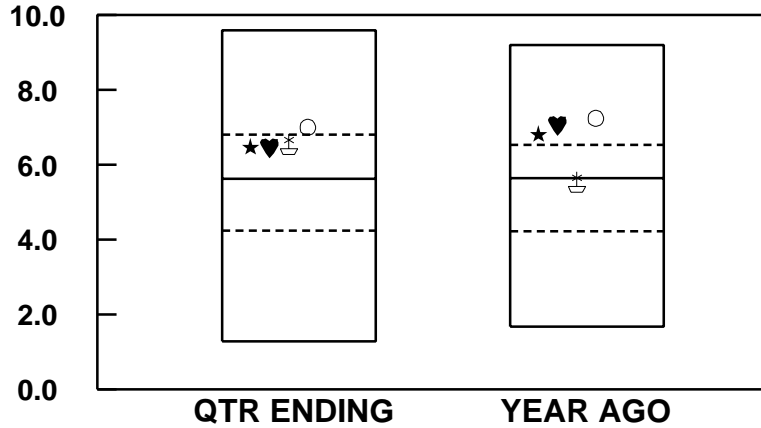

DURATION (YRS)

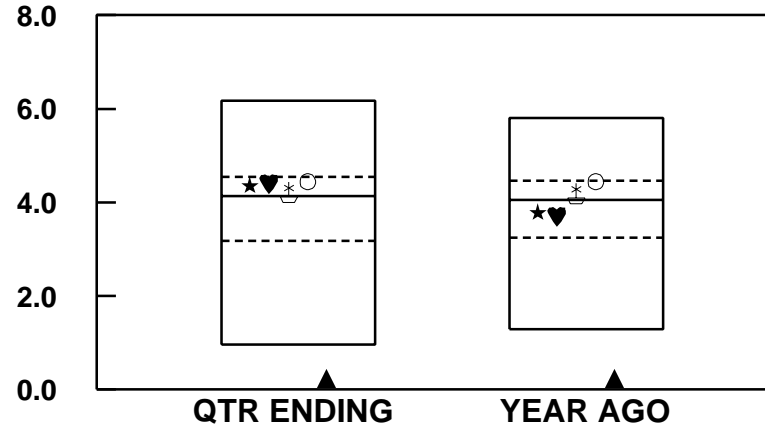

EFFECTS ON RETURN

- H
- MH
- ML
- L

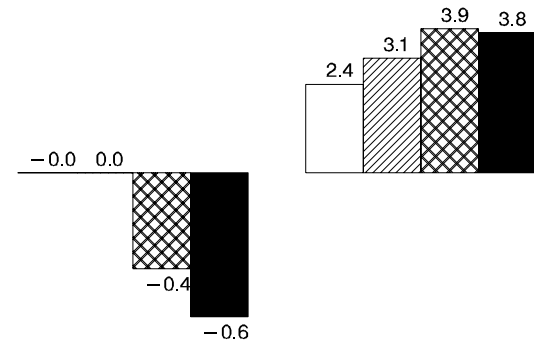
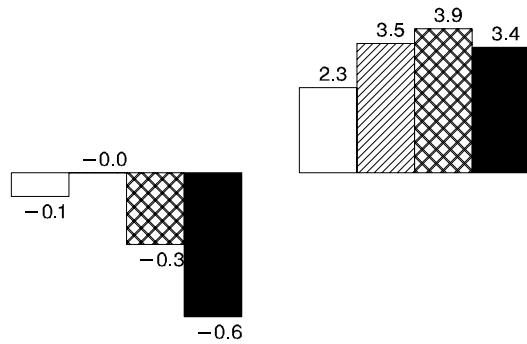

★ MUNI COMPOSITE	6.48	31	6.82	20
♥ SEIX CORE	6.47	32	7.07	17
⊕ SEIX HIGH YIELD	6.56	29	5.55	51
○ LB AGGREGATE	7.00	22	7.24	14
▲ 90 DAY T-BILLS				
MEDIAN	5.63		5.65	

	4.37	38	3.79	58
	4.40	37	3.71	61
	4.21	46	4.19	45
	4.44	29	4.45	26
	0.25	97	0.25	98
	4.13		4.05	

VERMONT MUNICIPAL EMPLOYEES

BOND PORTFOLIO CHARACTERISTICS

PERIODS ENDING 9/05

COUPON

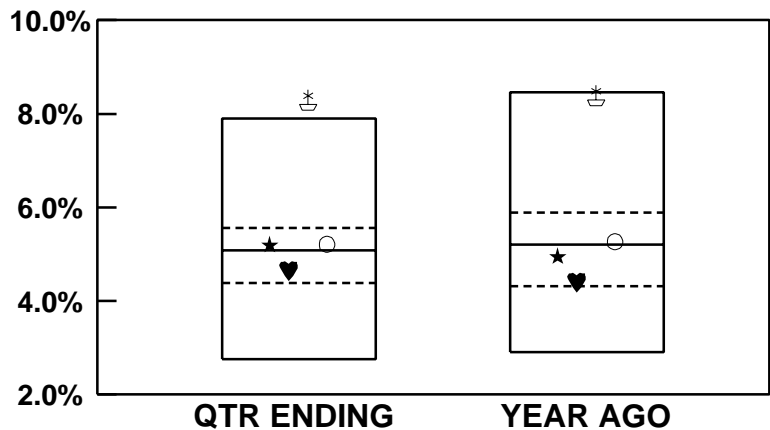

QUALITY

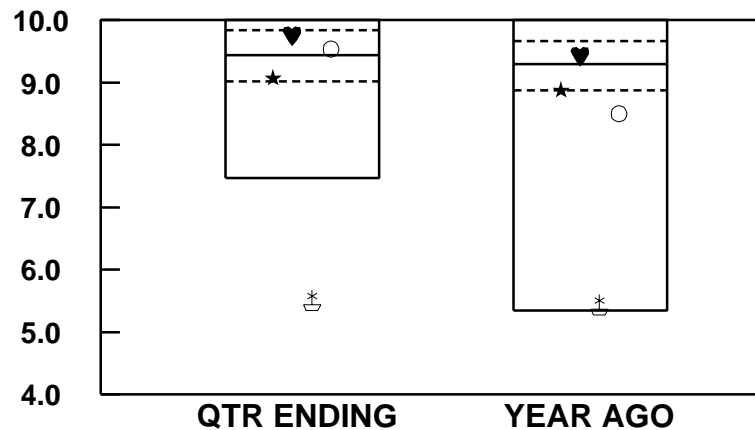

EFFECTS ON RETURN

- H
- MH
- ML
- L

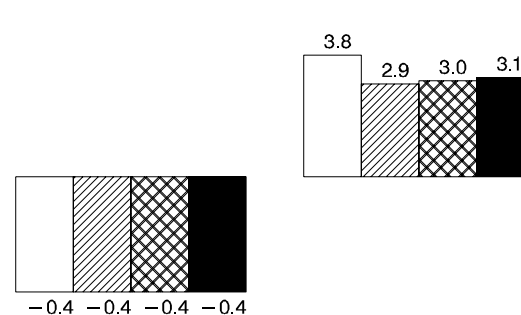
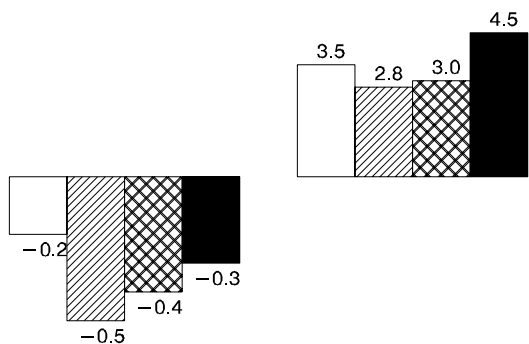

★ MUNI COMPOSITE	5.20	43	4.96	57	9.08	72	8.88	74
♥ SEIX CORE	4.65	67	4.41	73	9.76	29	9.43	40
⊕ SEIX HIGH YIELD	8.29	2	8.39	6	5.51	97	5.44	92
○ LB AGGREGATE	5.21	42	5.27	46	9.54	43	8.50	83
MEDIAN	5.08		5.20		9.44		9.30	

**VERMONT MUNICIPAL EMPLOYEES
FIXED INCOME SECTOR ALLOCATION
AS OF SEPTEMBER 30, 2005**

MUNICIPAL SYSTEM COMPOSITE

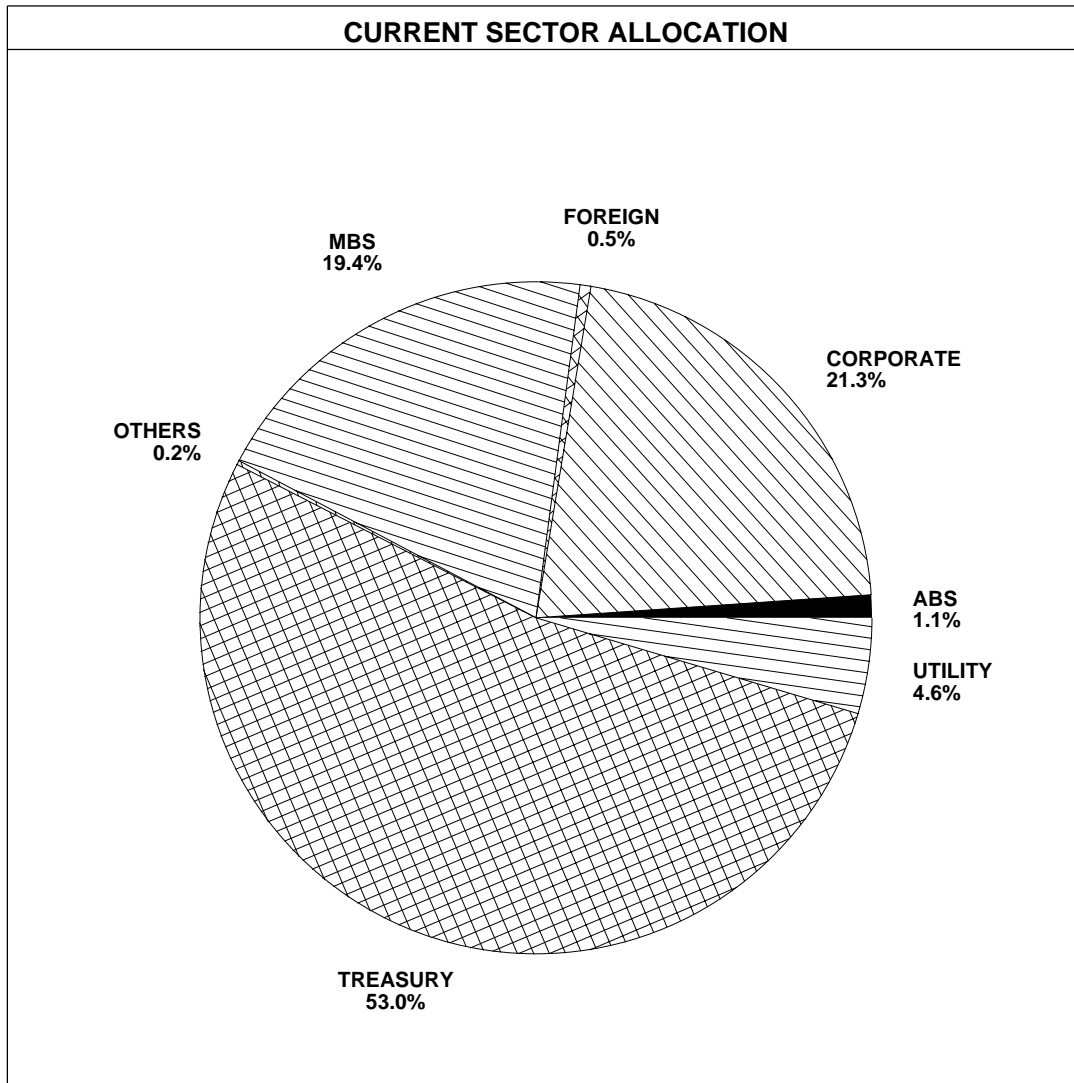

<u>SECTOR</u>	<u>ACCOUNT WEIGHT</u>	<u>INDEX WEIGHT</u>	<u>DIFFERENCE</u>
TREASURIES	53.0%	26.6%	26.4%
AGENCIES	0.0%	11.0%	-11.0%
CORPORATES	21.3%	17.8%	3.5%
UTILITIES	4.6%	1.9%	2.7%
FOREIGN	0.5%	4.1%	-3.6%
MBS	19.4%	33.7%	-14.3%
CMO	0.0%	0.0%	0.0%
ABS	1.1%	4.9%	-3.8%
MUNICIPALS	0.0%	0.0%	0.0%
OTHERS	0.2%	0.0%	0.2%
TOTAL	100.0%	100.0%	0.0%

Benchmark: LB AGGREGATE

VERMONT MUNICIPAL EMPLOYEES

FIXED INCOME SECTOR ALLOCATION

AS OF SEPTEMBER 30, 2005

SEIX CORE

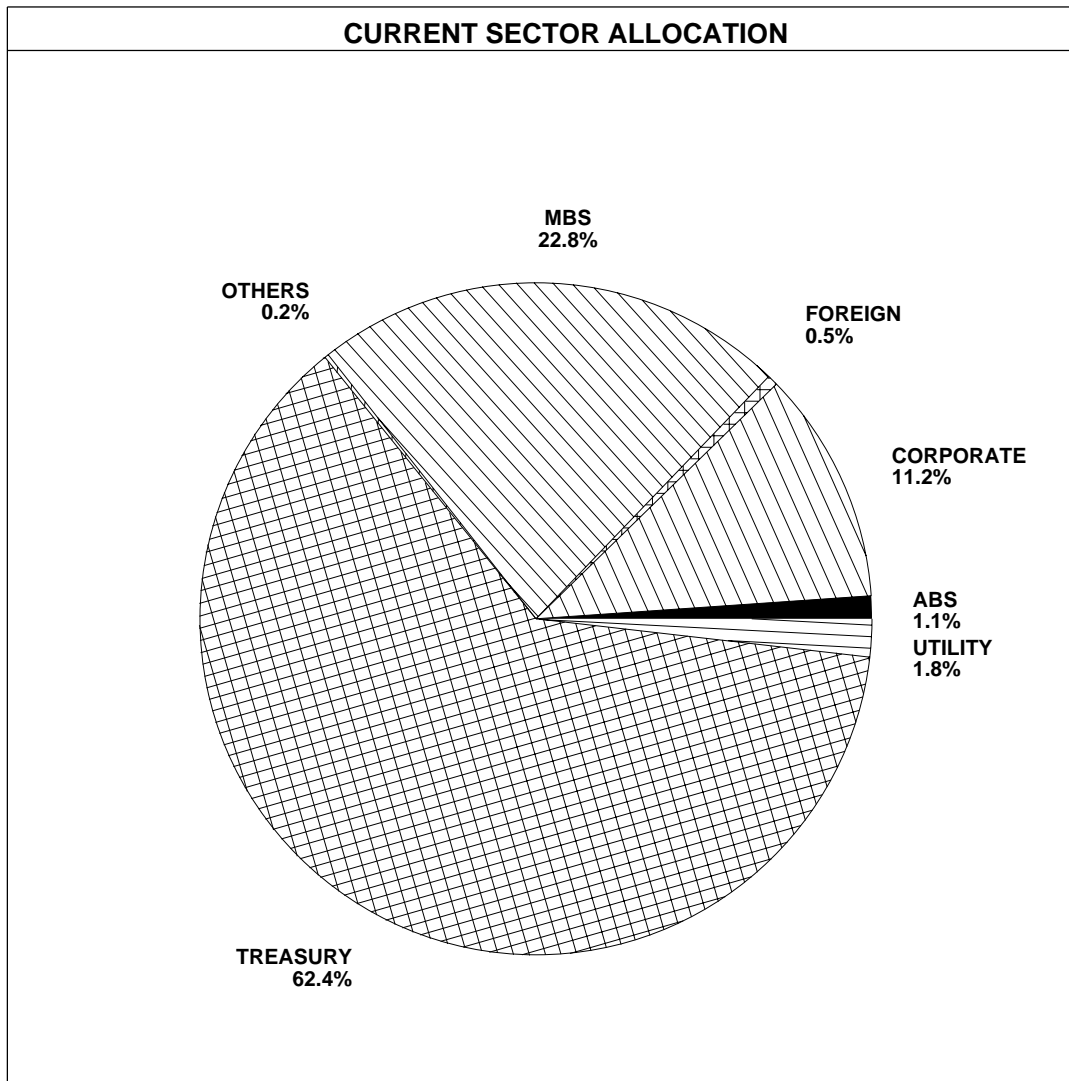

SECTOR	ACCOUNT WEIGHT	INDEX WEIGHT	DIFFERENCE
TREASURIES	62.4%	26.6%	35.8%
AGENCIES	0.0%	11.0%	-11.0%
CORPORATES	11.2%	17.8%	-6.6%
UTILITIES	1.8%	1.9%	-0.1%
FOREIGN	0.5%	4.1%	-3.5%
MBS	22.8%	33.7%	-10.9%
CMO	0.0%	0.0%	0.0%
ABS	1.1%	4.9%	-3.9%
MUNICIPALS	0.0%	0.0%	0.0%
OTHERS	0.2%	0.0%	0.2%
TOTAL	100.0%	100.0%	0.0%

Benchmark: LB AGGREGATE

VERMONT MUNICIPAL EMPLOYEES
FIXED INCOME SECTOR ALLOCATION
AS OF SEPTEMBER 30, 2005

SEIX HIGH YIELD

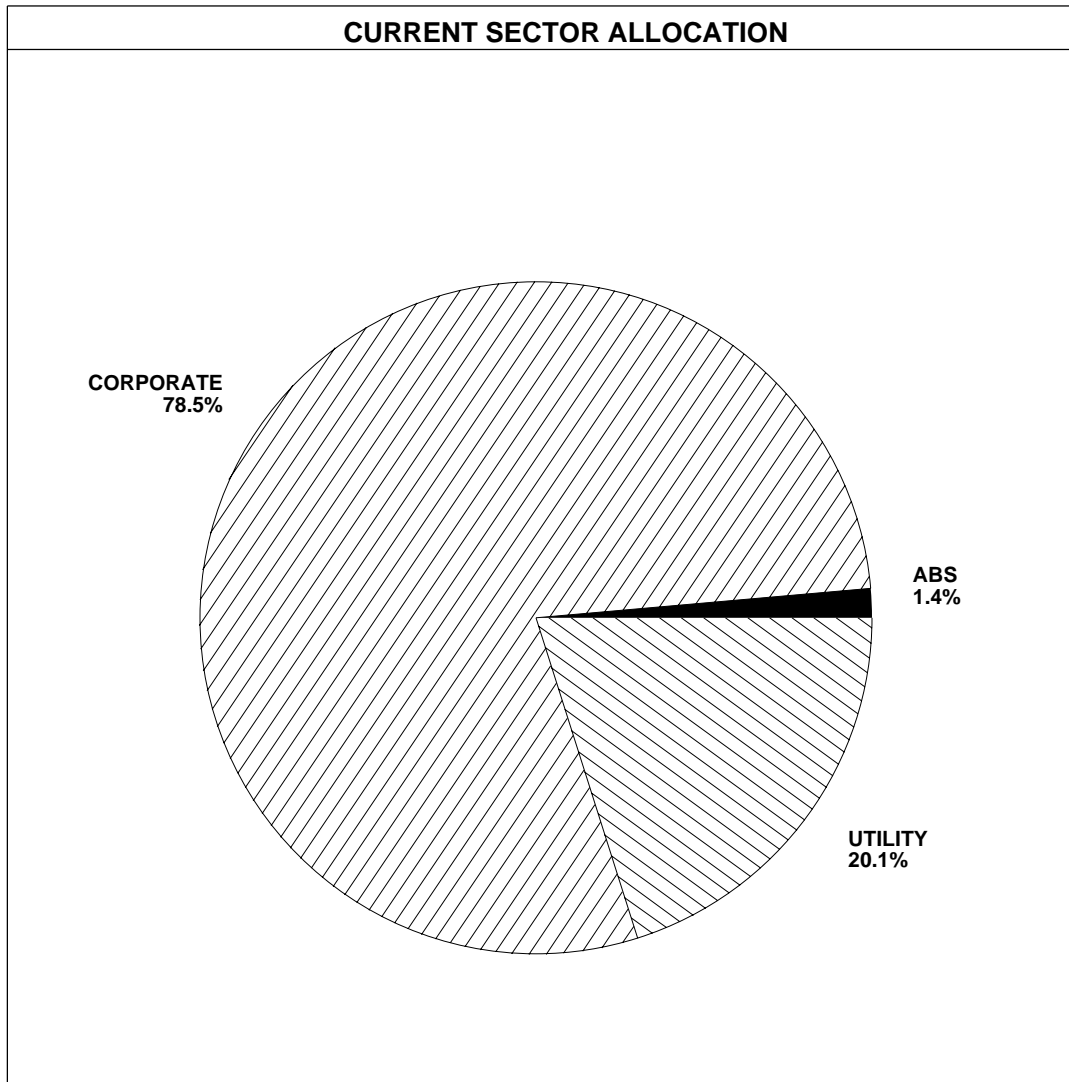

<u>SECTOR</u>	<u>ACCOUNT WEIGHT</u>	<u>INDEX WEIGHT</u>	<u>DIFFERENCE</u>
TREASURIES	0.0%	N/ A	N/ A
AGENCIES	0.0%	N/ A	N/ A
CORPORATES	78.5%	N/ A	N/ A
UTILITIES	20.1%	N/ A	N/ A
FOREIGN	0.0%	N/ A	N/ A
MBS	0.0%	N/ A	N/ A
CMO	0.0%	N/ A	N/ A
ABS	1.4%	N/ A	N/ A
MUNICIPALS	0.0%	N/ A	N/ A
OTHERS	0.0%	N/ A	N/ A
TOTAL	100.0%	N/ A	N/ A

Benchmark: CITI BB&B ALL

VERMONT MUNICIPAL EMPLOYEES

DURATION LINE ANALYSIS

QUARTER ENDING 9/05

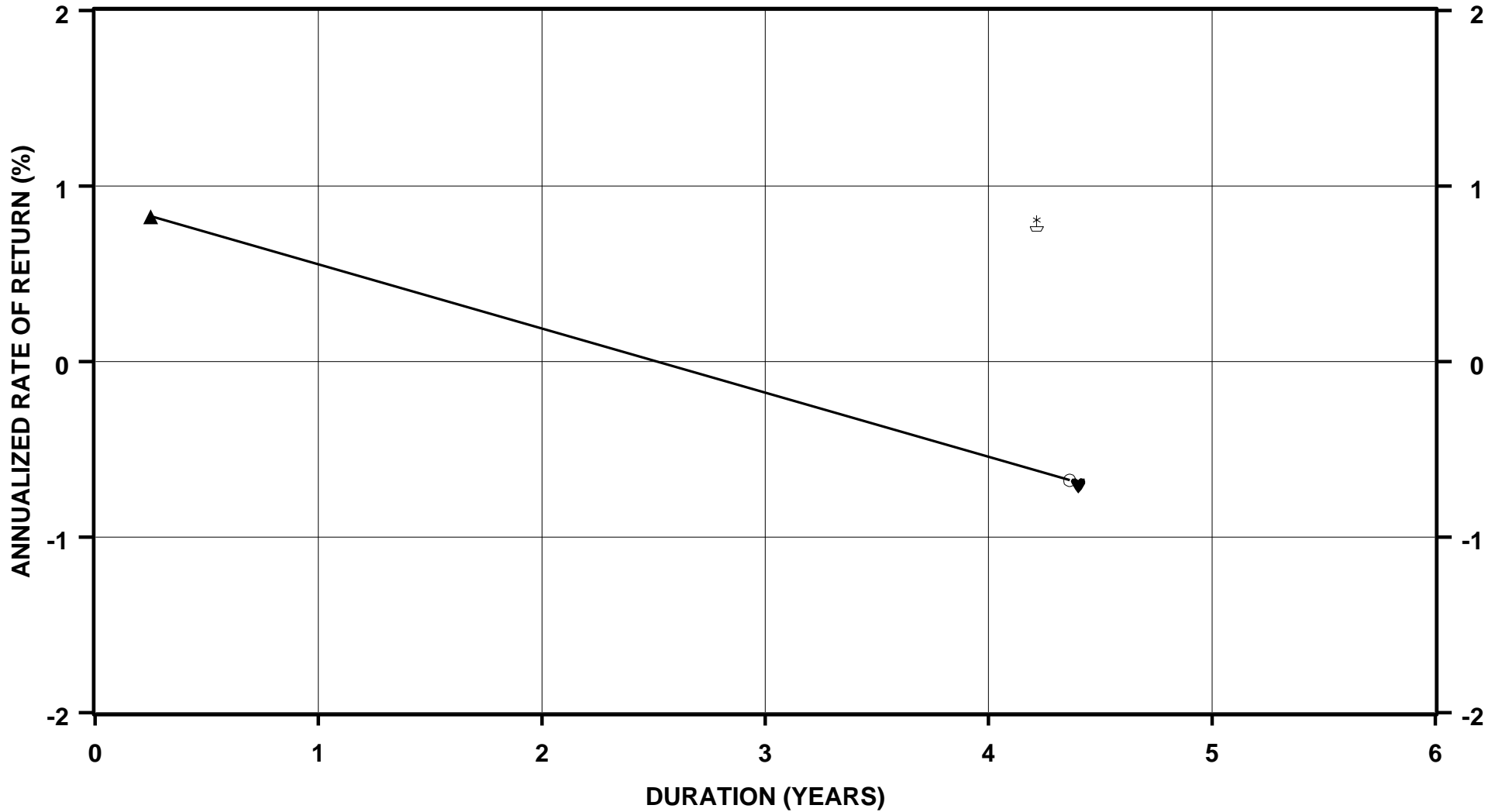

♥ SEIX CORE ⚡ SEIX HIGH YIELD ○ LB AGGREGATE
▲ 90 DAY T-BILLS

VERMONT MUNICIPAL EMPLOYEES
FIXED INCOME ATTRIBUTION - BOND FUNDS
QUARTER ENDING 9/05

<u>MANAGER</u>	<u>RETURN</u>	<u>BEGINNING DURATION</u>	<u>ENDING DURATION</u>	<u>AVERAGE DURATION</u>	<u>RETURN DUE TO MARKET</u>	<u>INTEREST RATE ANTICIPATION</u>	<u>SECURITY SELECTION</u>
SEIX CORE	- 0.70	4.08	4.40	4.24	- 0.60	- 0.06	- 0.04
SEIX HIGH YIELD	0.79	4.31	4.21	4.26	- 0.61	0.02	1.38
<u>BENCHMARKS</u>							
LB AGGREGATE	- 0.67	4.16	4.44	4.31			
90 DAY T-BILLS	0.83	0.25	0.25	0.25			
MARKET SENSITIVITY	- 0.36						

Due to Market = T-Bill return + (relative market sensitivity x (average duration - T-Bill duration))

Rate Anticipation = relative market sensitivity x current duration - average duration

Selection Effect = (account return - T-Bill return) - (relative market sensitivity x (current duration - T-Bill duration))

Relative Market Sensitivity = (Benchmark return - T-Bill return) / (Benchmark current duration - T-Bill duration)

Duration = Duration Option Adjusted Incl Cash Equiv

VERMONT MUNICIPAL EMPLOYEES
FIXED INCOME ATTRIBUTION - BOND ONLY
QUARTER ENDING 9/05

<u>MANAGER</u>	<u>RETURN</u>	<u>BEGINNING DURATION</u>	<u>ENDING DURATION</u>	<u>AVERAGE DURATION</u>	<u>RETURN DUE TO MARKET</u>	<u>INTEREST RATE ANTICIPATION</u>	<u>SECURITY SELECTION</u>
MUNI COMPOSITE	- 0.47	4.12	4.37	4.24	- 0.60	- 0.05	0.18
SEIX CORE	- 0.70	4.08	4.40	4.24	- 0.60	- 0.06	- 0.04
SEIX HIGH YIELD	0.79	4.31	4.21	4.26	- 0.61	0.02	1.38
<u>BENCHMARKS</u>							
LB AGGREGATE	- 0.67	4.16	4.44	4.31			
90 DAY T-BILLS	0.83	0.25	0.25	0.25			
MARKET SENSITIVITY	- 0.36						

Due to Market = T-Bill return + (relative market sensitivity x (average duration - T-Bill duration))

Rate Anticipation = relative market sensitivity x current duration - average duration

Selection Effect = (account return - T-Bill return) - (relative market sensitivity x (current duration - T-Bill duration))

Relative Market Sensitivity = (Benchmark return - T-Bill return) / (Benchmark current duration - T-Bill duration)

Duration = Duration Option Adjusted

VERMONT MUNICIPAL EMPLOYEES

BOND ONLY - RATES OF RETURN

COMPARED TO FUNDS WITH SIMILAR MATURITY

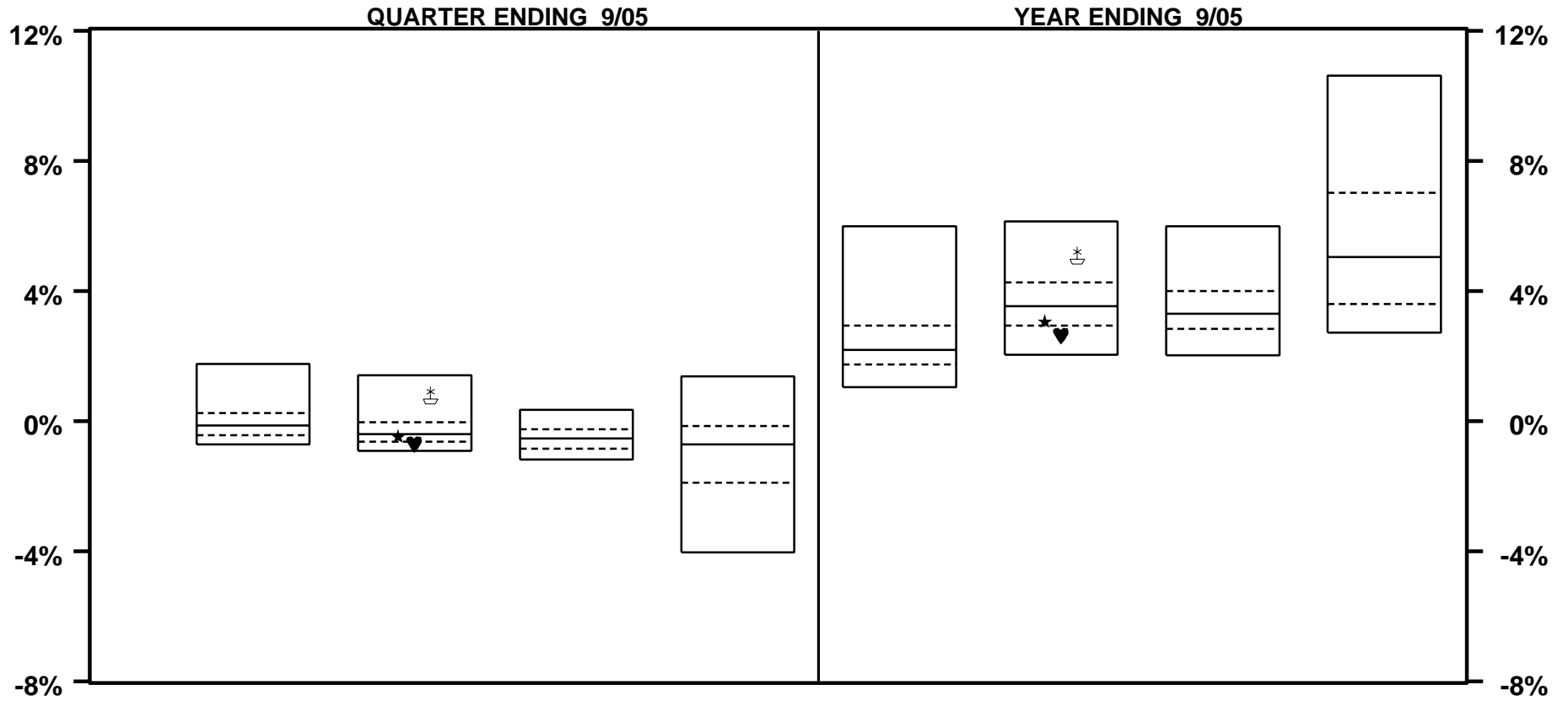

	QUARTER ENDING 9/05				YEAR ENDING 9/05			
	BELOW 5 YEARS	5-7 YEARS	7-9 YEARS	ABOVE 9 YEARS	BELOW 5 YEARS	5-7 YEARS	7-9 YEARS	ABOVE 9 YEARS
★ MUNI COMPOSITE		- 0.5				3.1		
♥ SEIX CORE		- 0.7				2.6		
⌘ SEIX HIGH YIELD		0.8				5.1		
MEDIAN	- 0.1	- 0.4	- 0.5	- 0.7	2.2	3.5	3.3	5.0

VERMONT MUNICIPAL EMPLOYEES

BOND ONLY - RATES OF RETURN

COMPARED TO FUNDS WITH SIMILAR MATURITY

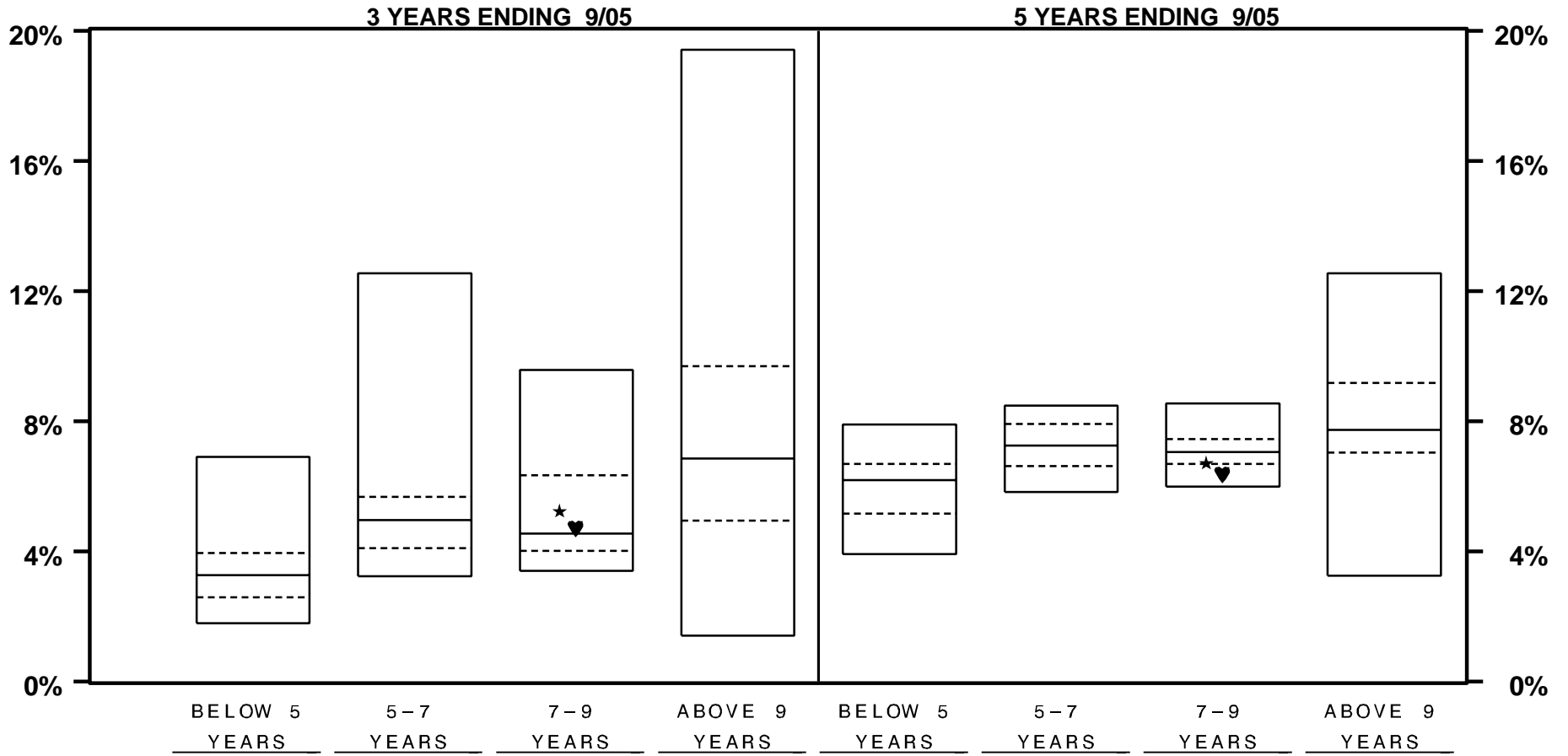

★ MUNI COMPOSITE
♥ SEIX CORE

	BELOW 5 YEARS	5-7 YEARS	7-9 YEARS	ABOVE 9 YEARS	BELOW 5 YEARS	5-7 YEARS	7-9 YEARS	ABOVE 9 YEARS
			5.2 35				6.7 74	
			4.7 42				6.4 86	
MEDIAN	3.3	5.0	4.5	6.9	6.2	7.3	7.0	7.7

VERMONT MUNICIPAL EMPLOYEES

BOND ONLY - RATES OF RETURN

COMPARED TO FUNDS WITH SIMILAR DURATION

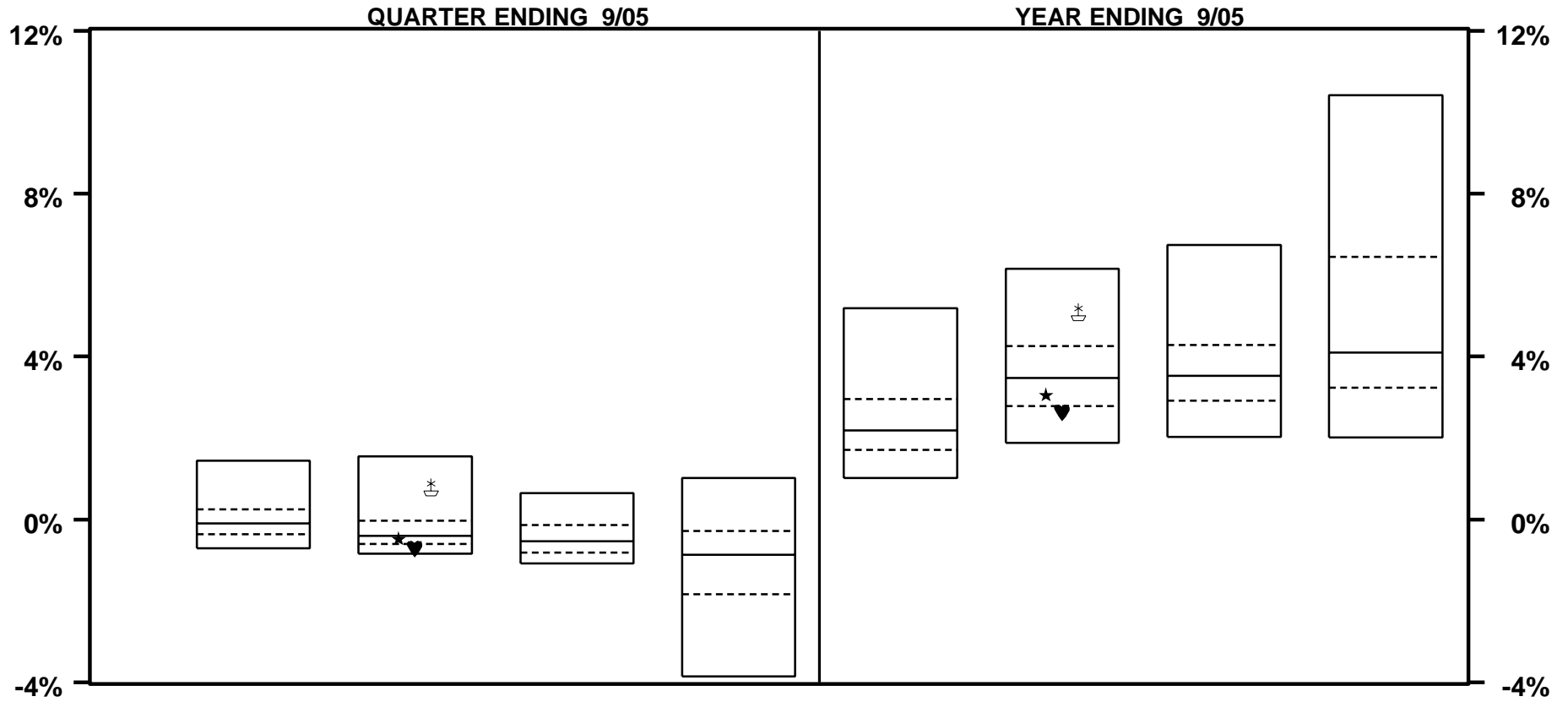

	BELOW 3.5 YEARS	3.5-4.5 YEARS	4.5-5.5 YEARS	ABOVE 5.5 YEARS	BELOW 3.5 YEARS	3.5-4.5 YEARS	4.5-5.5 YEARS	ABOVE 5.5 YEARS
★ MUNI COMPOSITE		- 0.5 59				3.1 62		
♥ SEIX CORE		- 0.7 87				2.6 81		
⚓ SEIX HIGH YIELD		0.8 13				5.1 12		
MEDIAN	- 0.1	- 0.4	- 0.5	- 0.9	2.2	3.5	3.5	4.1

VERMONT MUNICIPAL EMPLOYEES

BOND ONLY - RATES OF RETURN

COMPARED TO FUNDS WITH SIMILAR DURATION

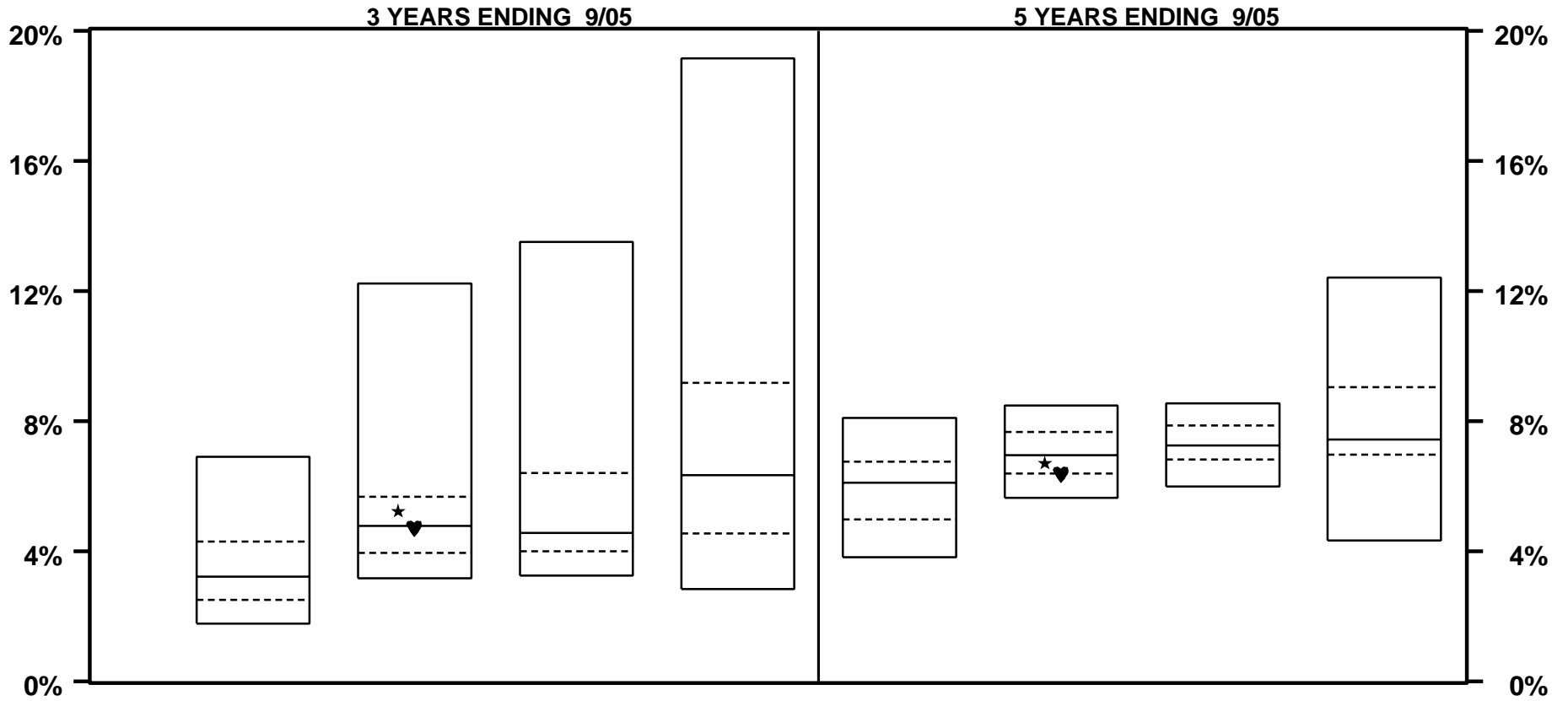

	3 YEARS ENDING 9/05				5 YEARS ENDING 9/05			
	BELOW 3.5 YEARS	3.5-4.5 YEARS	4.5-5.5 YEARS	ABOVE 5.5 YEARS	BELOW 3.5 YEARS	3.5-4.5 YEARS	4.5-5.5 YEARS	ABOVE 5.5 YEARS
★ MUNI COMPOSITE		5.2 40				6.7 61		
♥ SEIX CORE		4.7 51				6.4 75		
MEDIAN	3.2	4.8	4.6	6.3	6.1	7.0	7.3	7.4

VERMONT MUNICIPAL EMPLOYEES

BOND ONLY - RATES OF RETURN

COMPARED TO FUNDS WITH SIMILAR COUPON

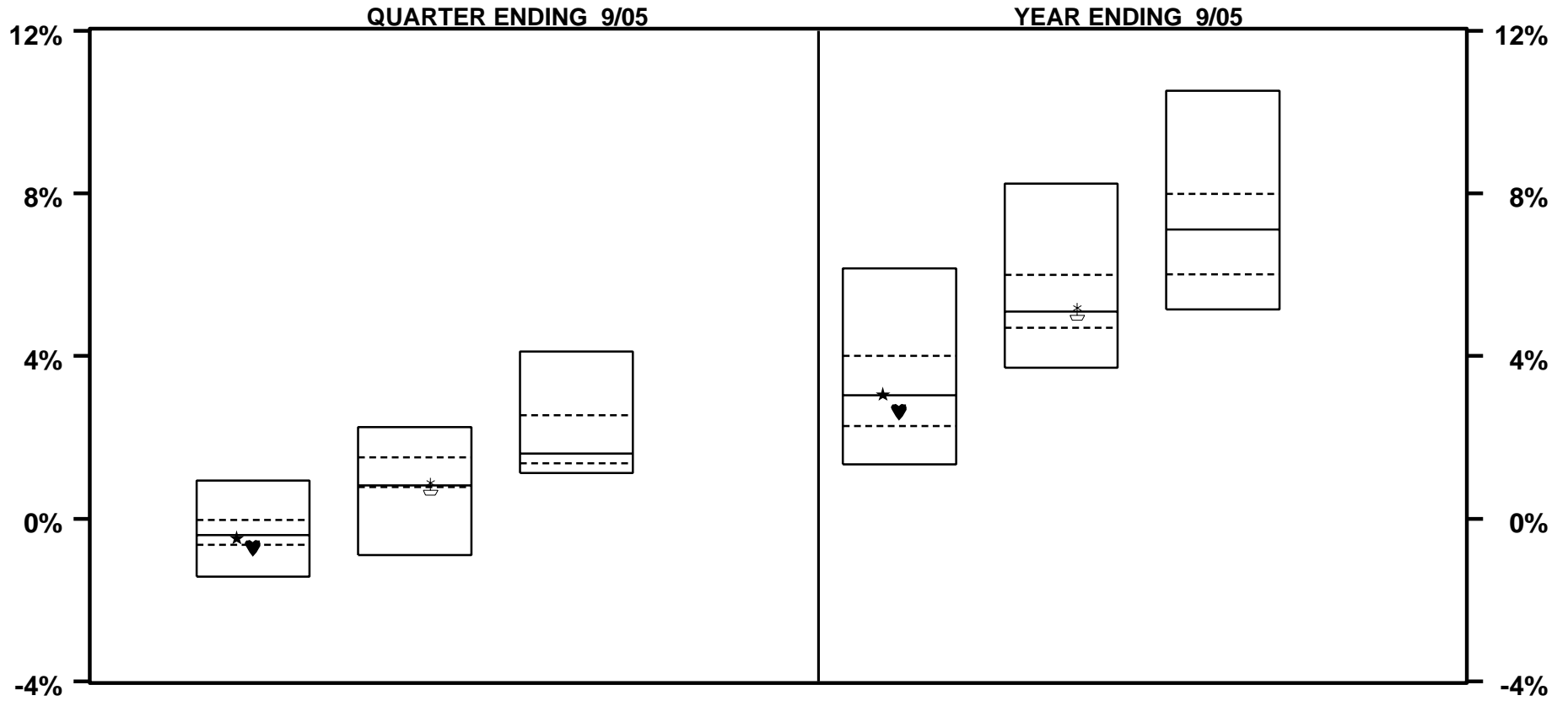

	QUARTER ENDING 9/05			YEAR ENDING 9/05		
	BELOW 8.0%	8.0-8.5%	8.5-9.0% ABOVE 9.0%	BELOW 8.0%	8.0-8.5%	8.5-9.0% ABOVE 9.0%
★ MUNI COMPOSITE	- 0.5		60	3.1		49
♥ SEIX CORE	- 0.7		81	2.6		66
⊠ SEIX HIGH YIELD		0.8	63		5.1	49
MEDIAN	- 0.4	0.8	1.6	3.0	5.1	7.1

VERMONT MUNICIPAL EMPLOYEES

BOND ONLY - RATES OF RETURN

COMPARED TO FUNDS WITH SIMILAR COUPON

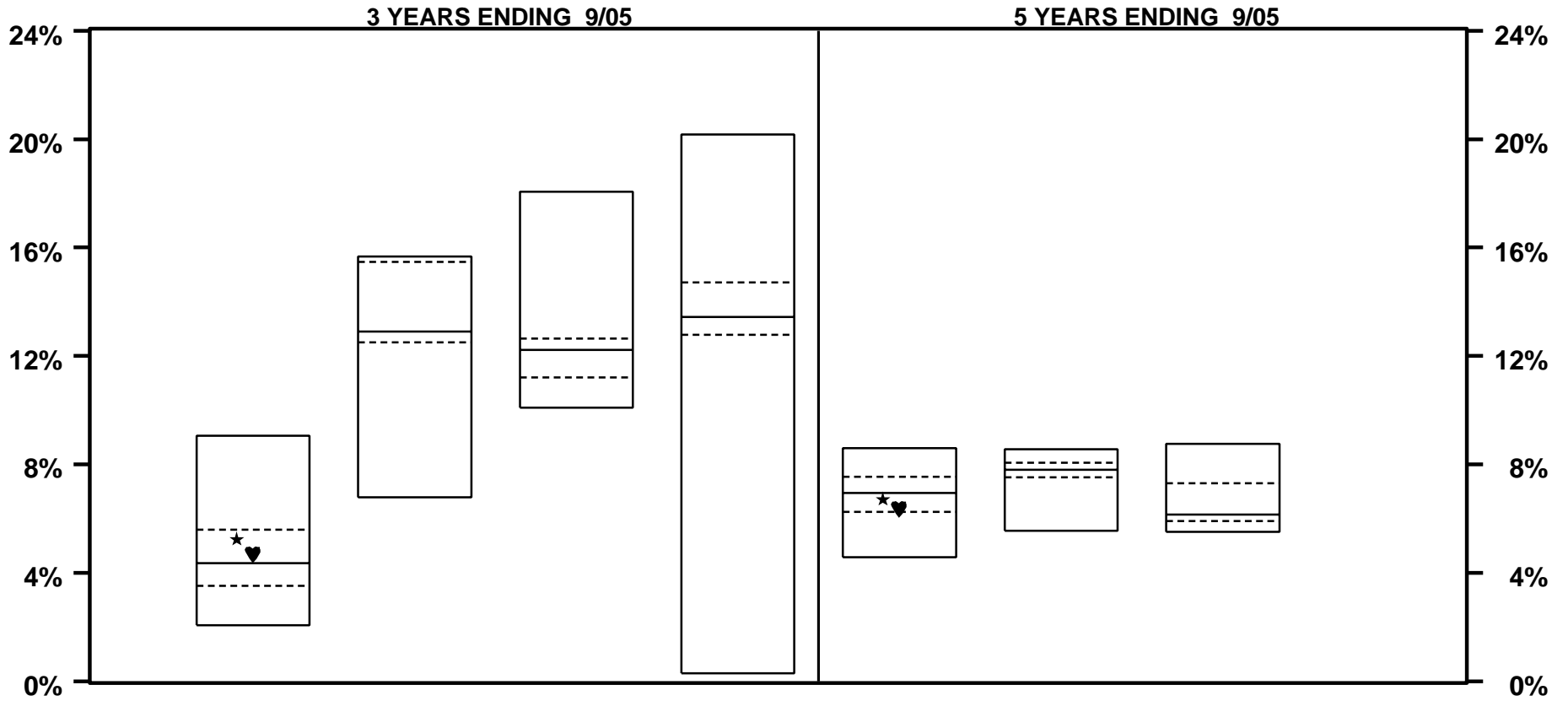

	3 YEARS ENDING 9/05				5 YEARS ENDING 9/05			
	BELOW	8.0-8.5%	8.5-9.0%	ABOVE	BELOW	8.0-8.5%	8.5-9.0%	ABOVE
	8.0%			9.0%	8.0%			9.0%
★ MUNI COMPOSITE	5.2	29			6.7	58		
♥ SEIX CORE	4.7	41			6.4	70		
MEDIAN	4.4	12.9	12.2	13.4	6.9	7.8	6.2	

VERMONT MUNICIPAL EMPLOYEES

FIXED INCOME MANAGER STYLE DEFINITIONS

SHORT

Short Term Fixed Income managers are generally retained as "cash" managers. They provide an alternative to SHORT TERM INVESTMENT VEHICLES and attempt to add value through superior management of high quality short term instruments. In order to be classified as Short Term, a managers portfolio duration should be 0-40% of the Lehman Brothers Aggregate's and an average quality rating of at least 6.3. Contractual restrictions limiting a short term fund's duration generally preclude the use of one of the major bond indices as a relevant benchmark. Instead, 90 day T-Bills are generally used as the portfolio's standard.

INTERMEDIATE

An Intermediate manager invests in high quality issues with a duration that is 40-80% of the Lehman Brothers Aggregate and an average quality rating of at least 6.3. Although many Intermediate managers are contractually prevented from extending a portfolio's maturity, other Intermediate managers assert that intermediate duration securities provide the best risk/reward trade-off relative to short and long duration instruments.

CORE

A Core manager differs from the above three styles in that he does not concentrate on achieving a superior return within a certain duration range. Instead, he prefers to emphasize sector or individual bond selection to create a portfolio whose duration is similar to the index's, but produces a superior return. A Core manager's defining criteria include a duration ranging from 80-120% of the Lehman Brothers Aggregate and an average quality rating of at least 6.3.

CORE PLUS

Core-plus fixed income management is a strategy of incorporating moderate allocations to nonbenchmark sectors in order to achieve excess return without taking on excessive additional risk. Core-plus portfolios typically include diversifying exposure to sovereign, high yield, and/or emerging market debt. Core-plus is an assigned style.

LONG

To be classified as a Long manager, an investment manager's portfolio must have a duration that is greater than 120% of the Lehman Brothers Aggregate's and an average quality rating of at least 6.3. Long managers believe that the increased return provided by the long end of the maturity spectrum compensates for the higher volatility of longer duration issues.

HIGH YIELD

A High Yield Manager invests in lower quality, higher yielding issues; generally companies in financial difficulty or with limited financing means. The debt issued by these types of companies carry higher rates to compensate for the increased credit risk. A High Yield manager emphasizes security selection to take advantage of the superior return produced by the debt of less credit-worthy companies. A High Yield manager's portfolio must have a current yield to maturity that is at least 120% of the Lehman Brothers Aggregate's and an average quality rating less than or equal to 6.3.

VERMONT MUNICIPAL EMPLOYEES

FIXED INCOME MANAGER STYLE ANALYSIS - TOTAL RETURNS

QUARTER ENDING 9/05

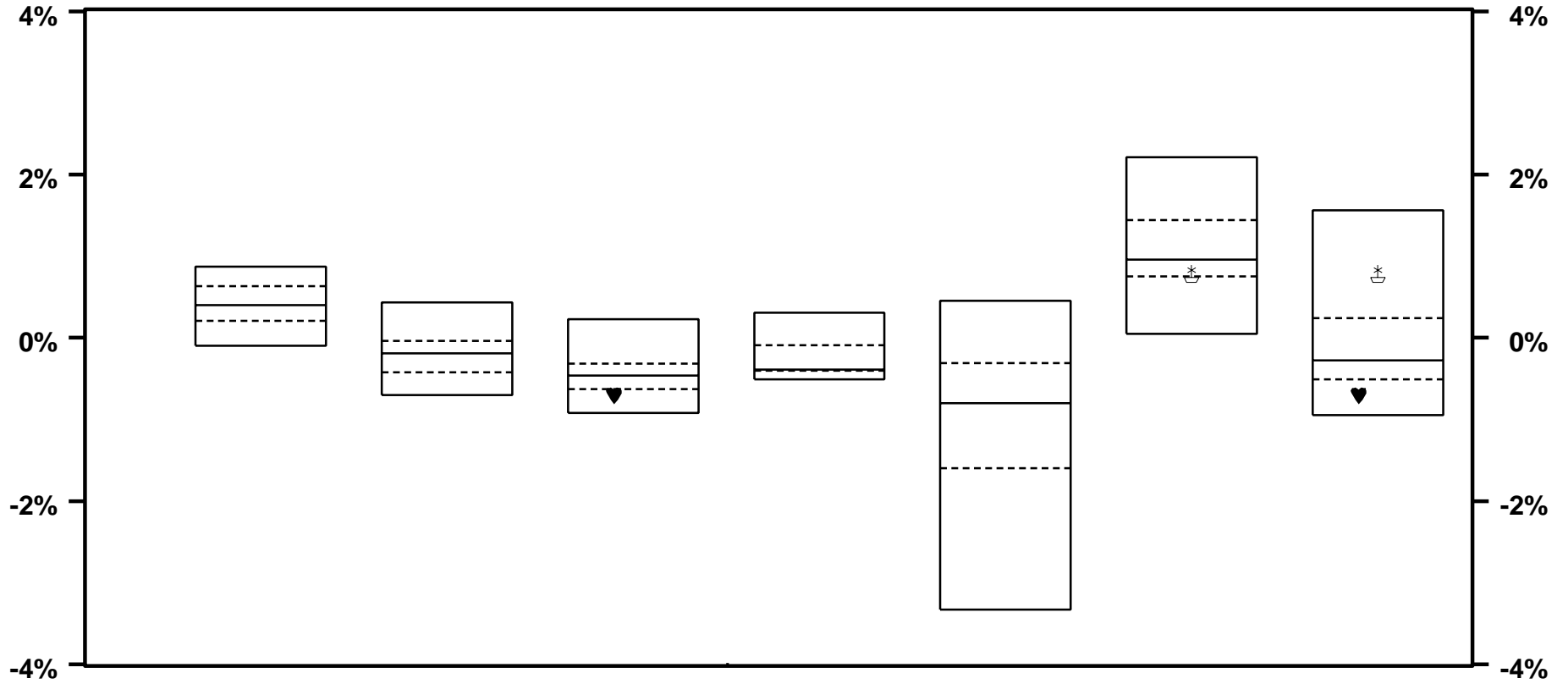

	SHORT	INTER-MEDIATE	CORE	CORE PLUS	LONG	HIGH YIELD	BOND UNIV
♥ SEIX CORE			- 0.7				- 0.7
☆ SEIX HIGH YIELD			85			0.8	89
MEDIAN	0.4	- 0.2	- 0.5	- 0.4	- 0.8	1.0	- 0.3
						63	14

VERMONT MUNICIPAL EMPLOYEES

FIXED INCOME MANAGER STYLE ANALYSIS - TOTAL RETURNS

YEAR ENDING 9/05

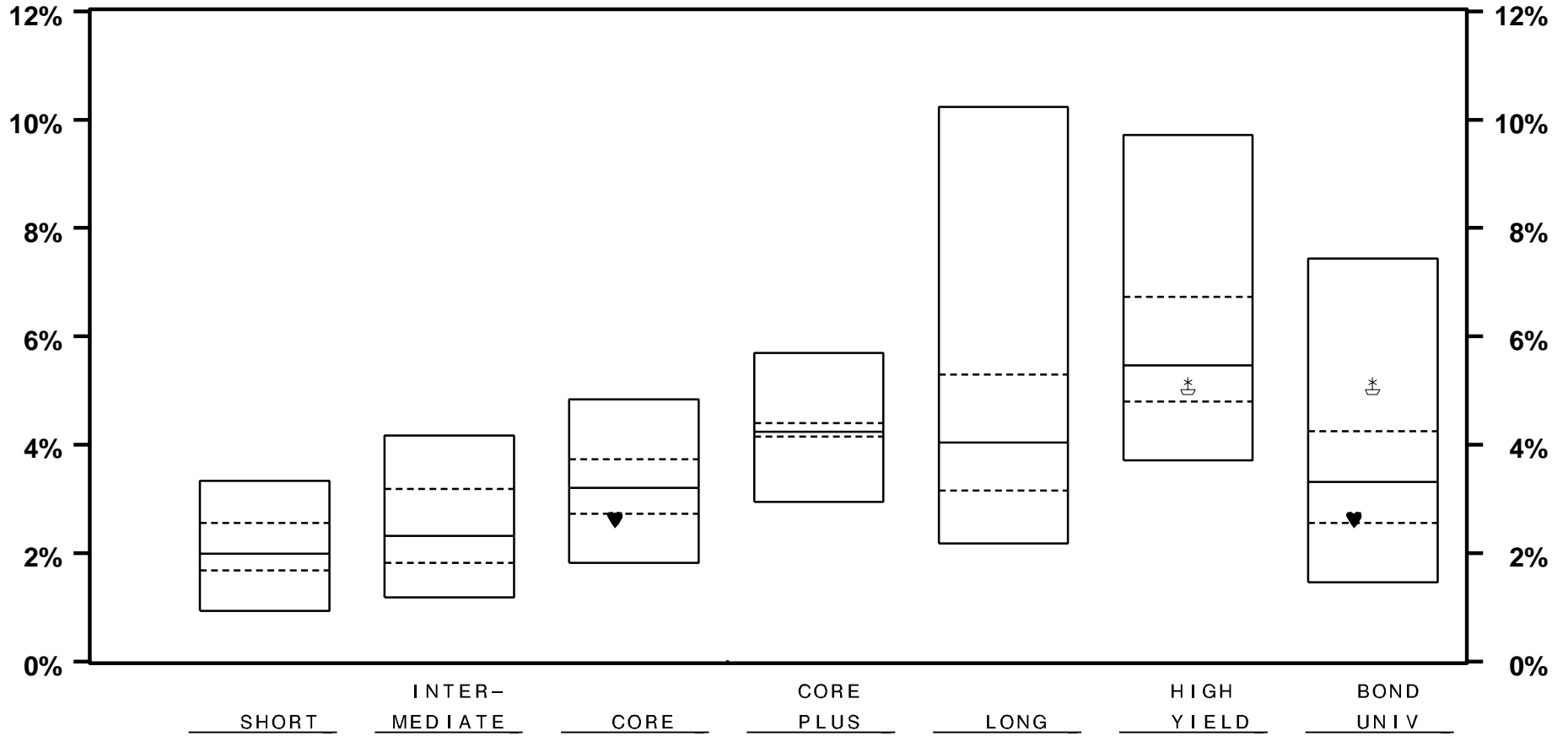

▼ SEIX CORE
 ⊕ SEIX HIGH YIELD

	SHORT	INTER-MEDIATE	CORE	CORE PLUS	LONG	HIGH YIELD	BOND UNIV
MEDIAN	2.0	2.3	3.2	4.2	4.0	5.5	3.3
			2.6 79			5.1 60	2.6 73 5.1 15

VERMONT MUNICIPAL EMPLOYEES

FIXED INCOME MANAGER STYLE ANALYSIS - TOTAL RETURNS

TWO YEARS ENDING 9/05

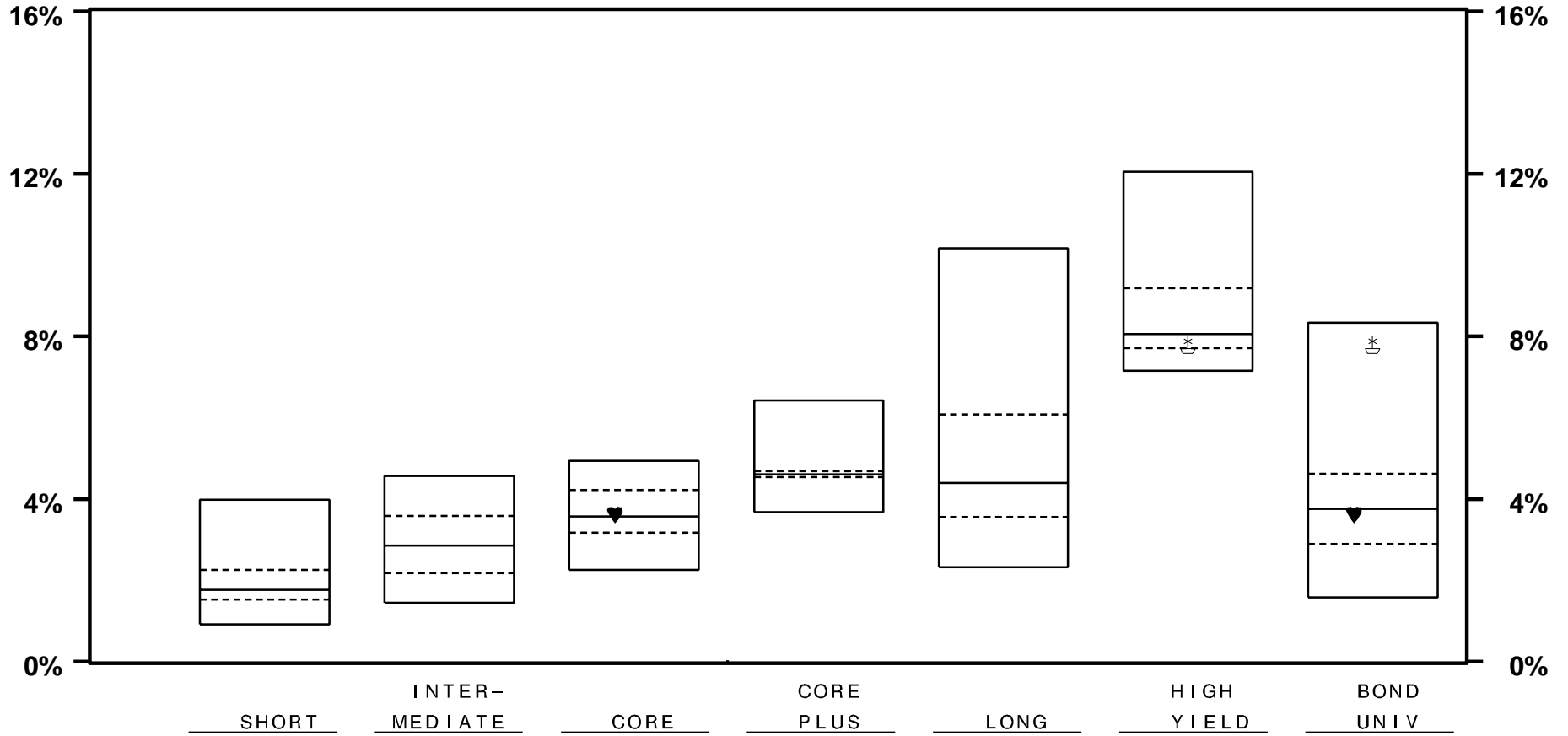

♥ SEIX CORE
 ⊕ SEIX HIGH YIELD

MEDIAN	1.8	2.9	3.6	4.6	4.4	8.1	3.8
			3.6 47			7.8 65	3.6 52
							7.8 7

VERMONT MUNICIPAL EMPLOYEES

FIXED INCOME MANAGER STYLE ANALYSIS - TOTAL RETURNS

THREE YEARS ENDING 9/05

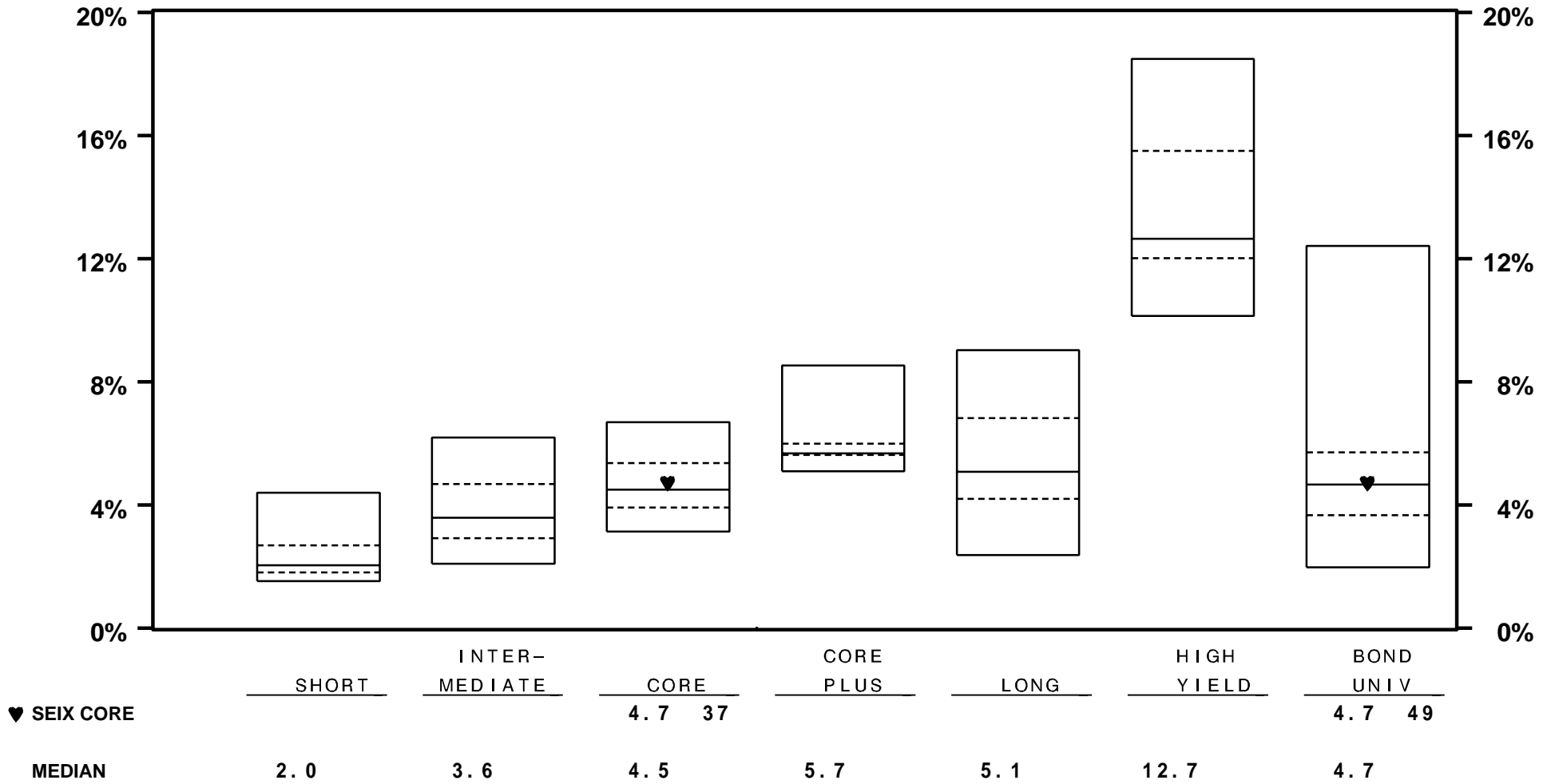

VERMONT MUNICIPAL EMPLOYEES

FIXED INCOME MANAGER STYLE ANALYSIS - TOTAL RETURNS

FOUR YEARS ENDING 9/05

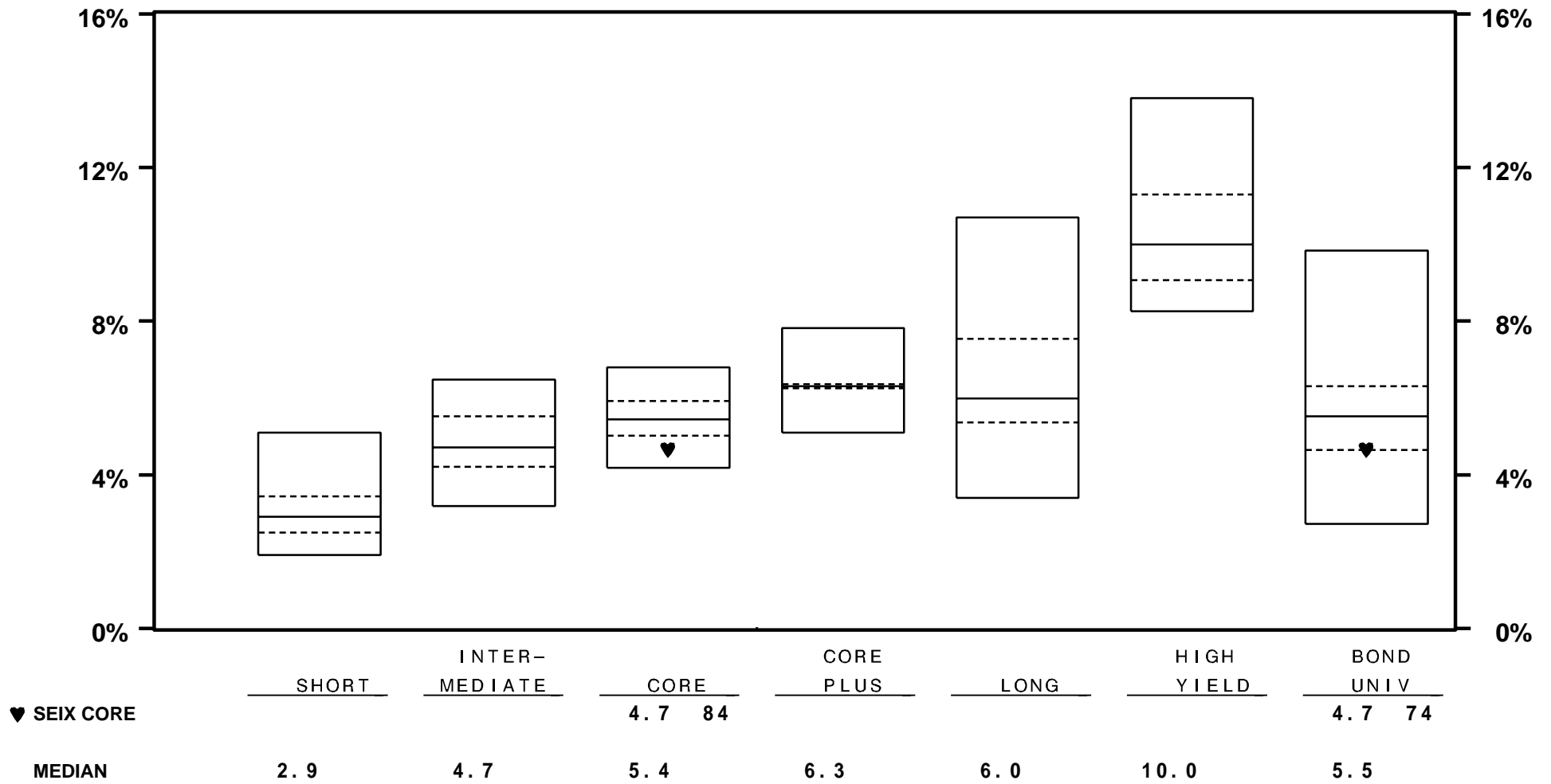

VERMONT MUNICIPAL EMPLOYEES

FIXED INCOME MANAGER STYLE ANALYSIS - TOTAL RETURNS

FIVE YEARS ENDING 9/05

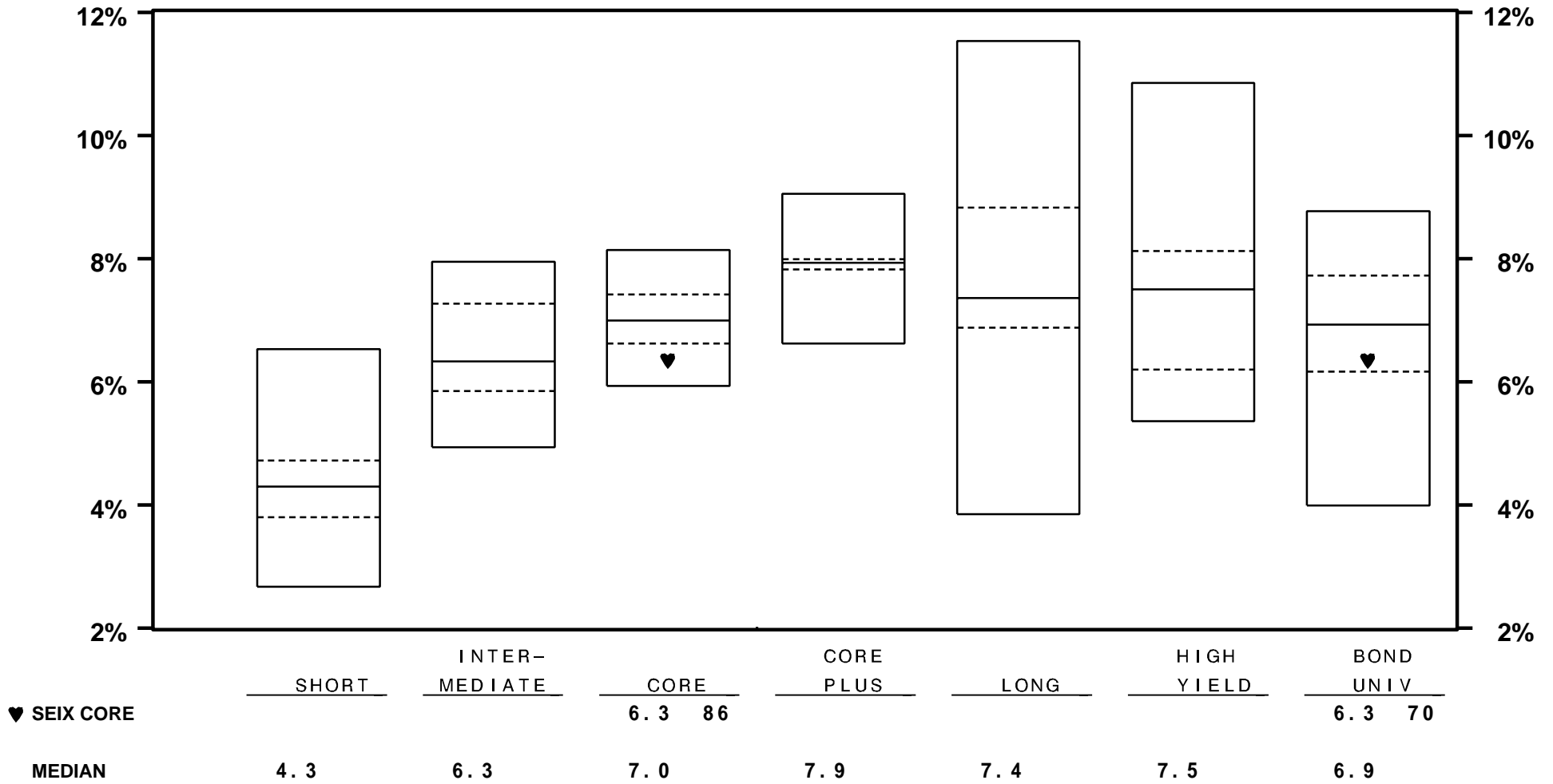

VERMONT MUNICIPAL EMPLOYEES

FIXED INCOME MANAGER STYLE ANALYSIS - BOND ONLY RETURNS

QUARTER ENDING 9/05

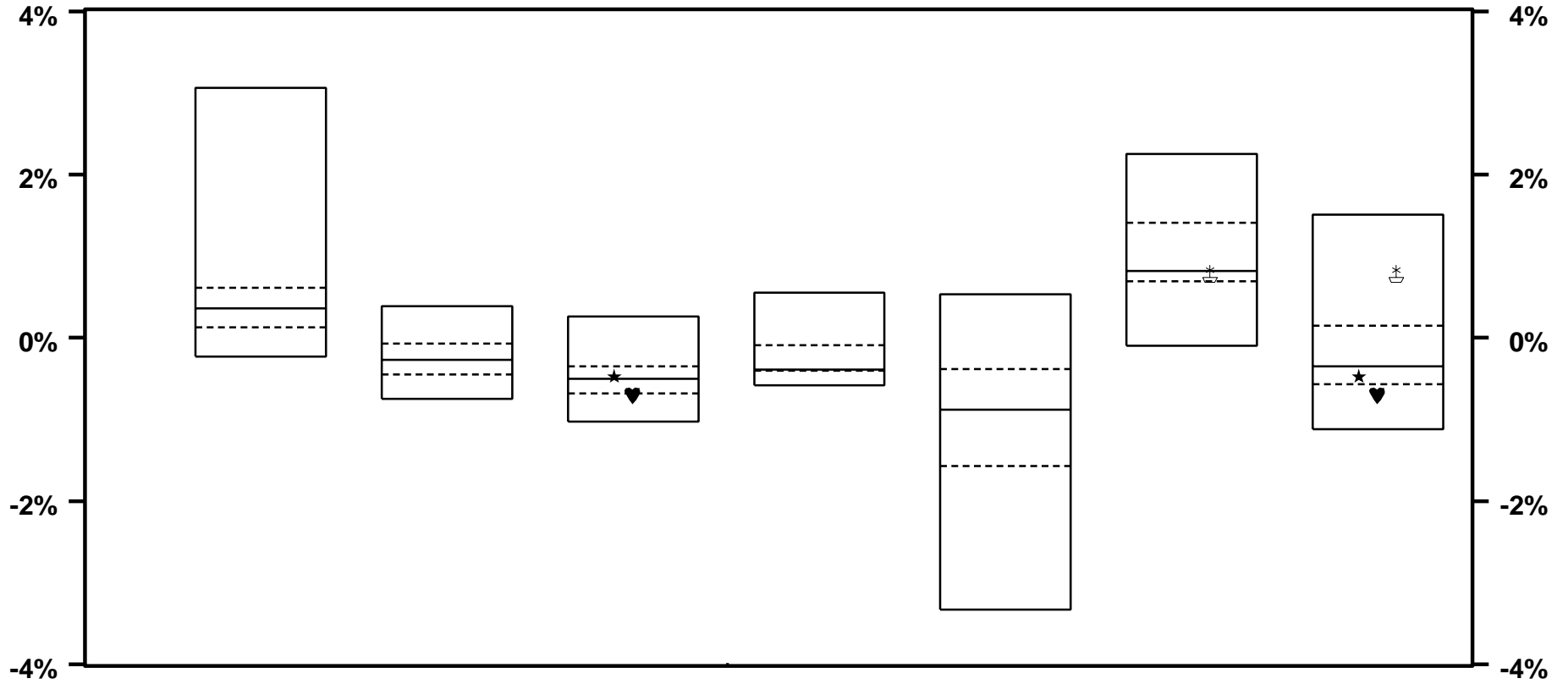

	SHORT	INTER-MEDIATE	CORE	CORE PLUS	LONG	HIGH YIELD	BOND UNIV
★ MUNI COMPOSITE			- 0.5 46				- 0.5 67
♥ SEIX CORE			- 0.7 77				- 0.7 86
⊕ SEIX HIGH YIELD						0.8 57	0.8 11
MEDIAN	0.4	- 0.3	- 0.5	- 0.4	- 0.9	0.8	- 0.4

VERMONT MUNICIPAL EMPLOYEES

FIXED INCOME MANAGER STYLE ANALYSIS - BOND ONLY RETURNS

YEAR ENDING 9/05

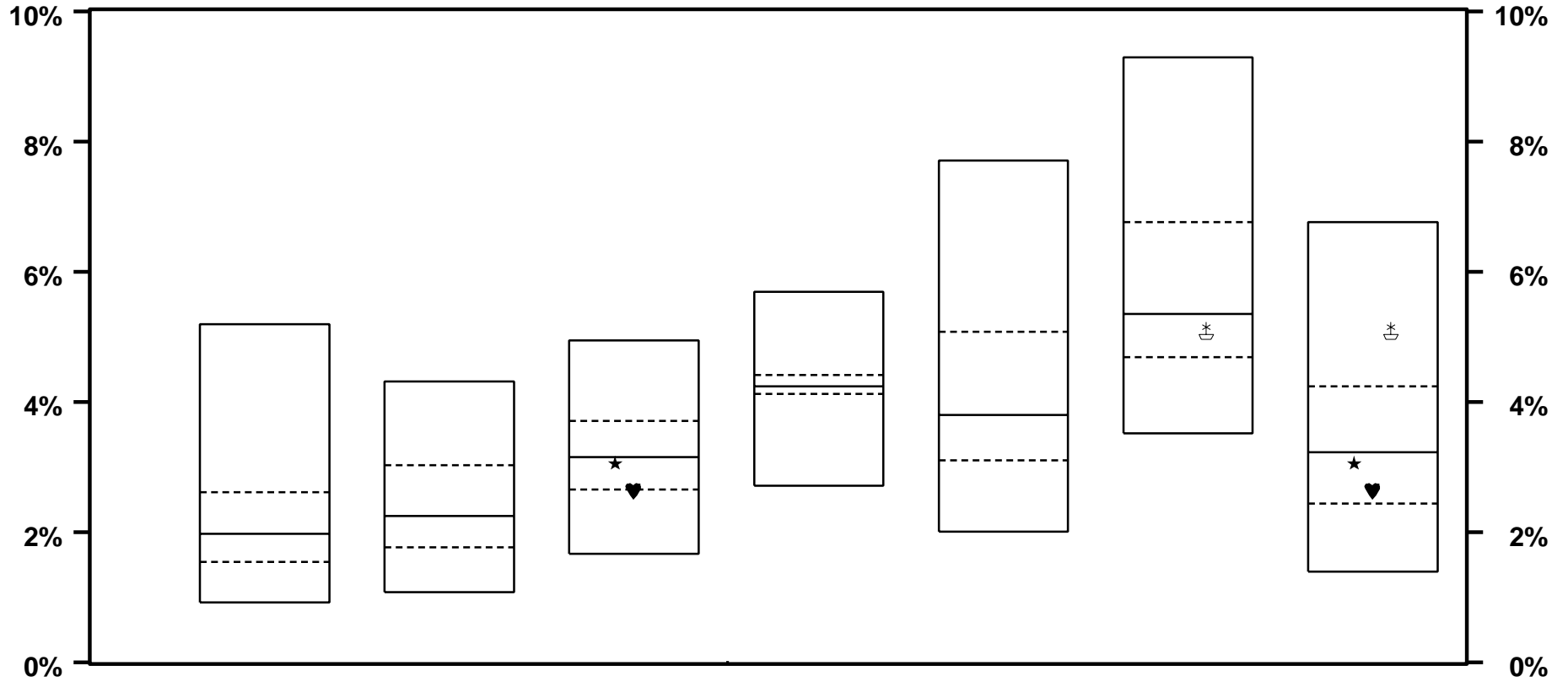

	SHORT	INTER-MEDIATE	CORE	CORE PLUS	LONG	HIGH YIELD	BOND UNIV
★ MUNI COMPOSITE			3.1				3.1
♥ SEIX CORE			2.6				2.6
⊕ SEIX HIGH YIELD						5.1	5.1
MEDIAN	2.0	2.3	3.1	4.2	3.8	5.4	3.2
			54			56	55
			75				70
							14

VERMONT MUNICIPAL EMPLOYEES

FIXED INCOME MANAGER STYLE ANALYSIS - BOND ONLY RETURNS

TWO YEARS ENDING 9/05

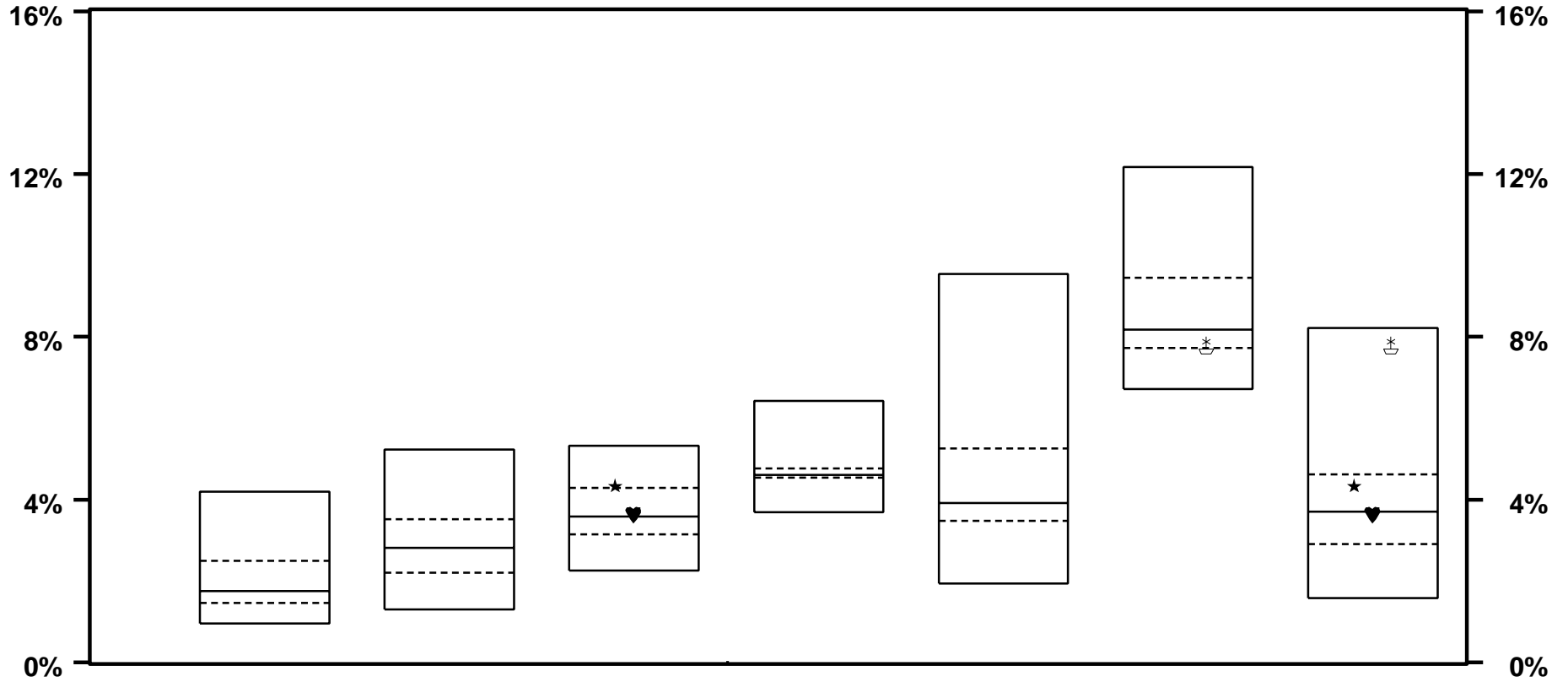

	SHORT	INTER-MEDIATE	CORE	CORE PLUS	LONG	HIGH YIELD	BOND UNIV
★ MUNI COMPOSITE			4.3				4.3
♥ SEIX CORE			3.6				3.6
⊕ SEIX HIGH YIELD						7.8	7.8
MEDIAN	1.8	2.8	3.6	4.6	3.9	8.2	3.7
			22			71	35
			47				52
							7

VERMONT MUNICIPAL EMPLOYEES

FIXED INCOME MANAGER STYLE ANALYSIS - BOND ONLY RETURNS

THREE YEARS ENDING 9/05

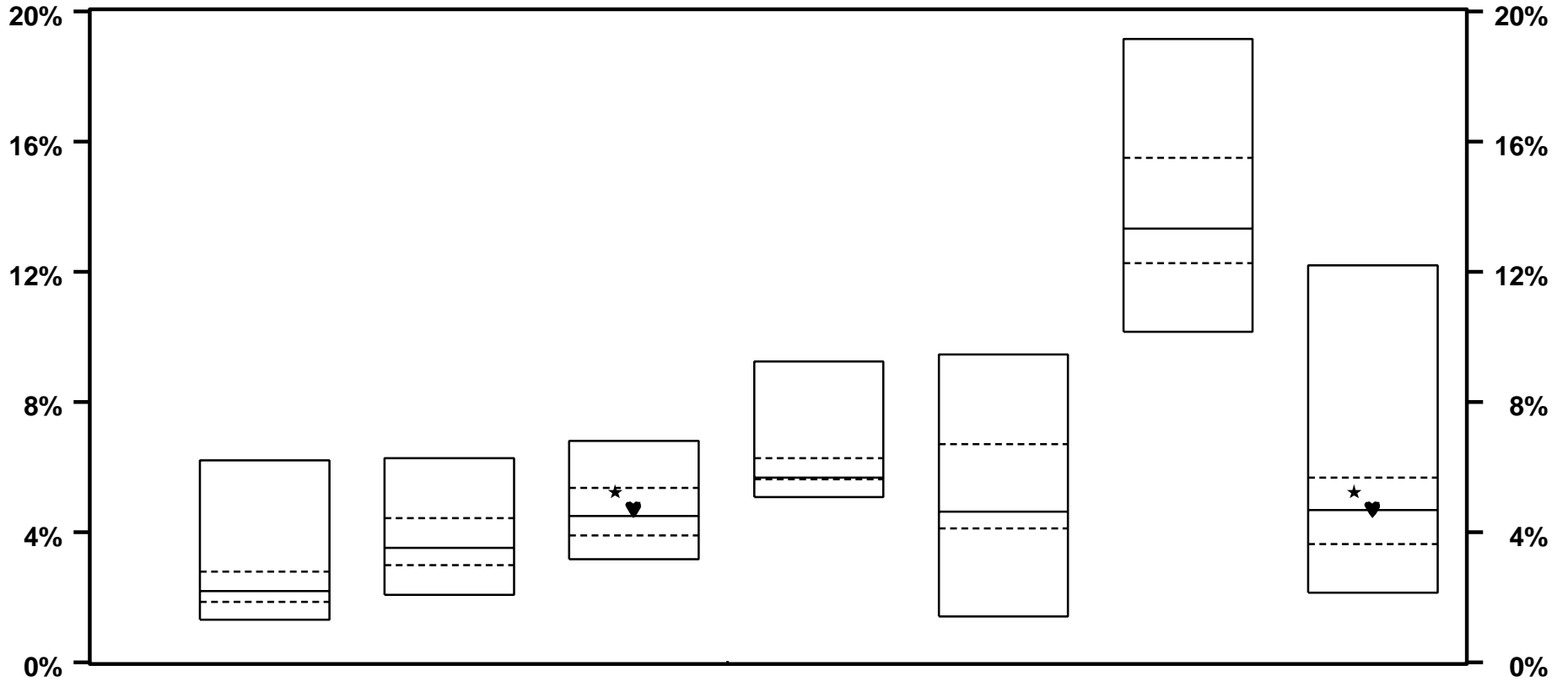

	SHORT	INTER-MEDIATE	CORE	CORE PLUS	LONG	HIGH YIELD	BOND UNIV
★ MUNI COMPOSITE			5.2				5.2
♥ SEIX CORE			4.7				4.7
MEDIAN	2.2	3.5	4.5	5.7	4.6	13.3	4.7
			26				37
			41				49

VERMONT MUNICIPAL EMPLOYEES

FIXED INCOME MANAGER STYLE ANALYSIS - BOND ONLY RETURNS

FOUR YEARS ENDING 9/05

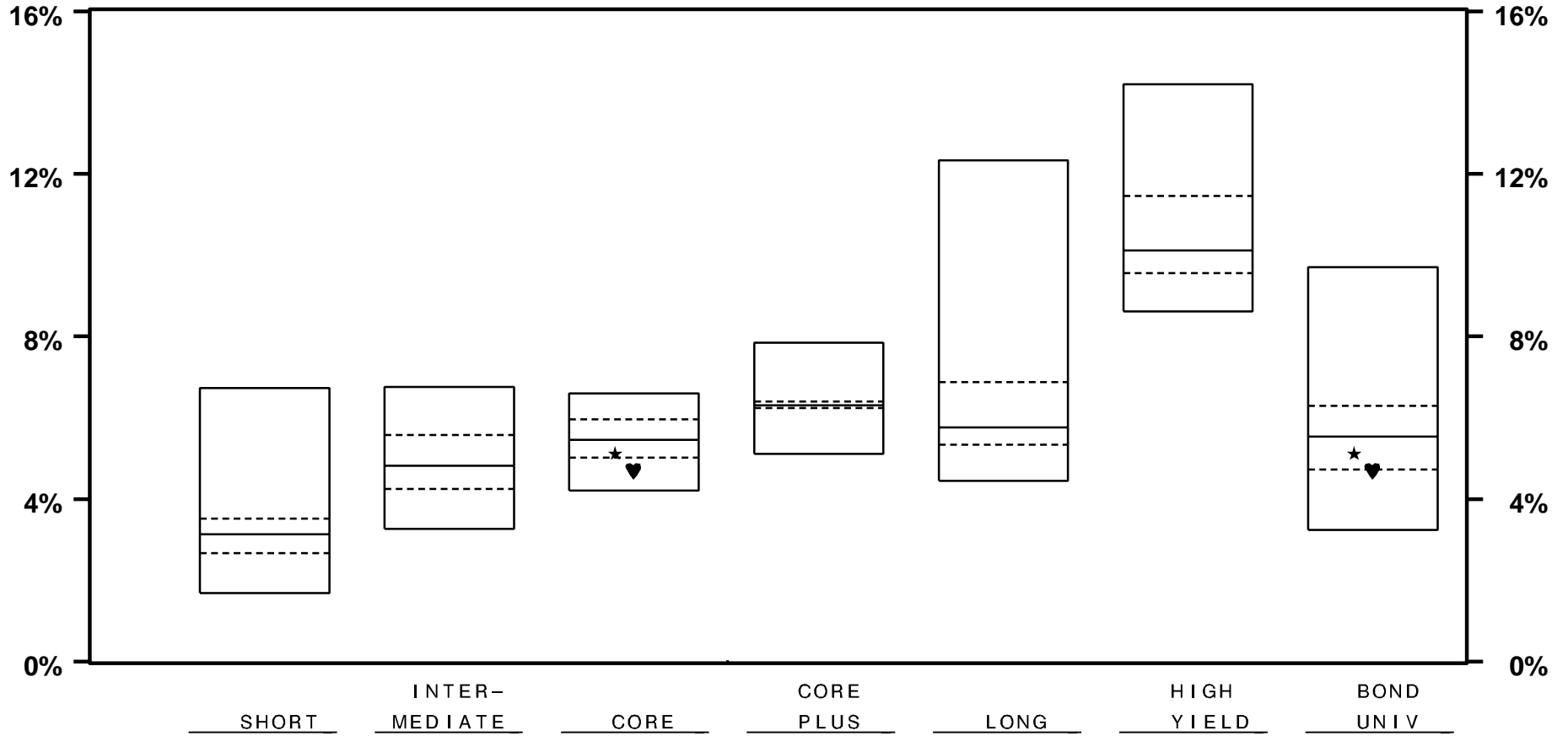

★ MUNI COMPOSITE
♥ SEIX CORE

	SHORT	INTER-MEDIATE	CORE	CORE PLUS	LONG	HIGH YIELD	BOND UNIV
			5.1 69				5.1 63
			4.7 83				4.7 75

MEDIAN 3.1 4.8 5.5 6.3 5.8 10.1 5.5

VERMONT MUNICIPAL EMPLOYEES

FIXED INCOME MANAGER STYLE ANALYSIS - BOND ONLY RETURNS

FIVE YEARS ENDING 9/05

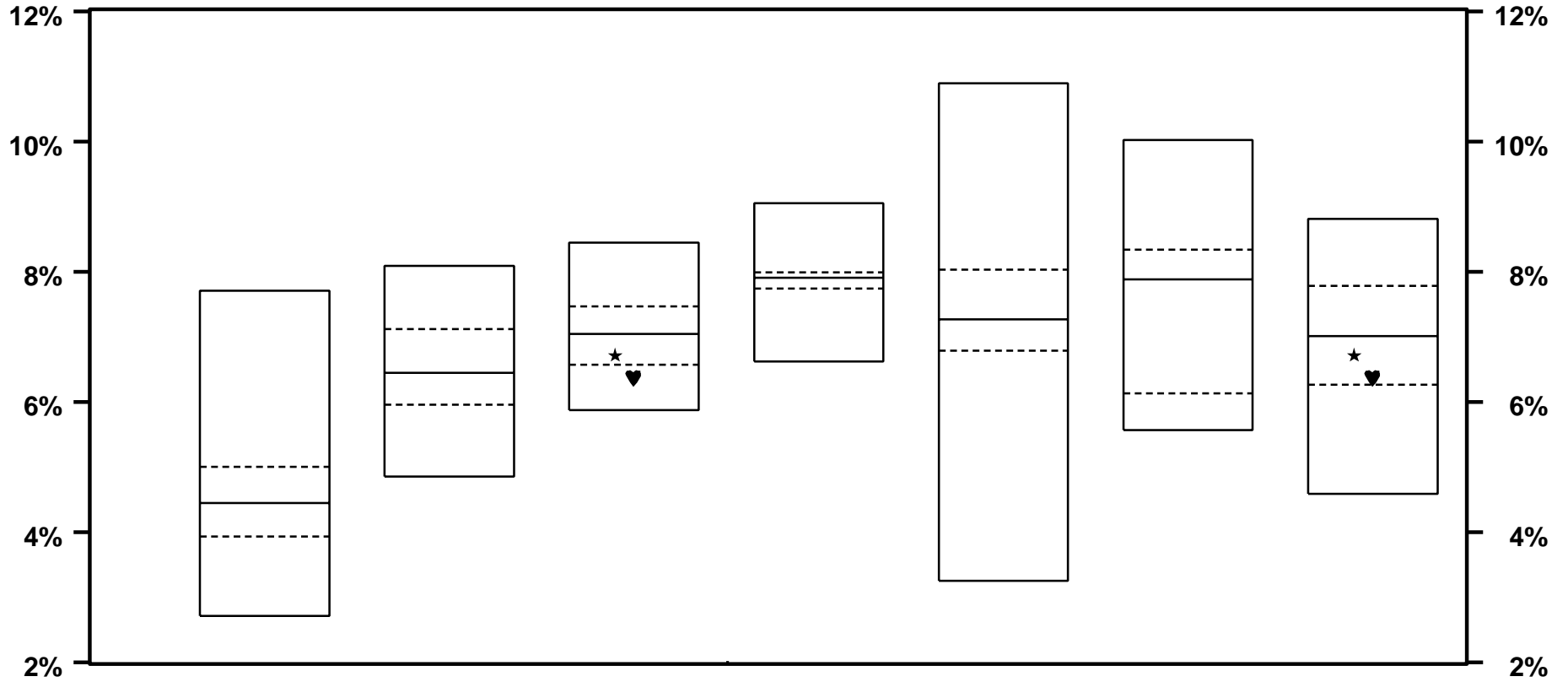

	SHORT	INTER-MEDIATE	CORE	CORE PLUS	LONG	HIGH YIELD	BOND UNIV
★ MUNI COMPOSITE			6.7 69				6.7 60
♥ SEIX CORE			6.4 79				6.4 71
MEDIAN	4.5	6.5	7.0	7.9	7.3	7.9	7.0

VERMONT MUNICIPAL EMPLOYEES

SOURCES OF PORTFOLIO GROWTH (\$000)

MUNICIPAL SYSTEM COMPOSITE

PERIOD ENDING	BEGINNING MARKET VALUE	NET CONTRIB	INCOME RECEIVED	GAIN (LOSS)	ENDING MARKET VALUE	TOTAL RETURN
12/00	168,240	366	0	2,035	170,641	1.2
3/01	170,641	-25	0	-7,468	163,148	-4.4
6/01	163,148	3,226	837	4,904	172,115	3.5
9/01	172,115	472	848	-10,618	162,817	-5.7
12/01	162,817	243	513	9,484	173,055	6.1
3/02	173,055	1,135	490	2,296	176,977	1.6
6/02	176,977	857	761	-6,878	171,715	-3.5
9/02	171,715	994	1,201	-17,722	156,188	-9.7
12/02	156,188	2,089	759	6,029	165,064	4.3
3/03	165,064	5,941	868	-4,721	167,152	-2.3
6/03	167,152	270	799	17,100	185,321	10.7
9/03	185,321	664	891	5,261	192,137	3.3
12/03	192,137	2,358	970	14,746	210,212	8.1
3/04	210,212	2,901	831	4,250	218,194	2.4
6/04	218,194	1,635	694	203	220,726	0.4
9/04	220,726	1,004	1,139	-1,129	221,740	0.0
12/04	221,740	2,177	5,478	10,352	239,747	7.1
3/05	239,747	2,393	837	-4,163	238,815	-1.4
6/05	238,815	1,153	484	5,286	245,739	2.4
9/05	245,739	1,241	3,057	6,838	256,875	4.0

VERMONT MUNICIPAL EMPLOYEES

SOURCES OF PORTFOLIO GROWTH (\$000)

DOMESTIC EQUITY COMPOSITE

PERIOD ENDING	BEGINNING MARKET VALUE	NET CONTRIB	INCOME RECEIVED	GAIN (LOSS)	ENDING MARKET VALUE	TOTAL RETURN
12/00	73,935	1	0	- 1,513	72,423	- 2.1
3/01	72,423	0	0	- 6,591	65,832	- 9.1
6/01	65,832	- 33	155	4,286	70,241	6.7
9/01	70,241	- 30	172	- 8,997	61,386	- 12.6
12/01	61,386	14	143	8,272	69,816	13.7
3/02	69,816	- 33	142	1,528	71,452	2.4
6/02	71,452	1,965	150	- 7,660	65,908	- 10.4
9/02	65,908	6,721	668	- 11,998	61,299	- 17.6
12/02	61,299	219	168	2,827	64,514	4.9
3/03	64,514	9,969	176	- 2,633	72,027	- 3.6
6/03	72,027	1,993	191	11,543	85,754	16.1
9/03	85,754	- 40	207	3,577	89,499	4.4
12/03	89,499	- 5,041	210	9,788	94,456	11.8
3/04	94,456	- 44	219	2,102	96,733	2.5
6/04	96,733	957	147	1,704	99,540	1.9
9/04	99,540	- 43	277	- 3,479	96,296	- 3.2
12/04	96,296	1,954	4,337	5,179	107,767	9.7
3/05	107,767	- 2,049	229	- 3,735	102,212	- 3.3
6/05	102,212	1,957	231	3,183	107,582	3.3
9/05	107,582	- 51	1,925	3,867	113,323	5.4

VERMONT MUNICIPAL EMPLOYEES

SOURCES OF PORTFOLIO GROWTH (\$000)

DELAWARE

PERIOD ENDING	BEGINNING MARKET VALUE	NET CONTRIB	INCOME RECEIVED	GAIN (LOSS)	ENDING MARKET VALUE	TOTAL RETURN
12/00	26,354	0	0	2,630	28,984	10.0
3/01	28,984	0	0	-1,141	27,843	-3.9
6/01	27,843	0	155	926	28,925	3.9
9/01	28,925	0	160	-3,452	25,632	-11.4
12/01	25,632	49	143	2,049	27,874	8.6
3/02	27,874	0	142	1,406	29,422	5.5
6/02	29,422	0	149	-2,363	27,208	-7.5
9/02	27,208	0	152	-5,222	22,137	-18.6
12/02	22,137	0	161	1,611	23,909	8.0
3/03	23,909	4,500	176	-1,650	26,935	-5.4
6/03	26,935	1,527	191	4,819	33,472	18.2
9/03	33,472	1	207	648	34,329	2.6
12/03	34,329	-1,000	210	4,121	37,660	12.9
3/04	37,660	0	219	450	38,329	1.8
6/04	38,329	0	147	585	39,060	1.9
9/04	39,060	0	213	-672	38,601	-1.2
12/04	38,601	0	207	3,167	41,975	8.7
3/05	41,975	0	229	-766	41,437	-1.3
6/05	41,437	0	231	312	41,980	1.3
9/05	41,980	0	234	877	43,091	2.6

VERMONT MUNICIPAL EMPLOYEES

SOURCES OF PORTFOLIO GROWTH (\$000)

ALLIANCE LARGE CAP GROWTH FUND

PERIOD ENDING	BEGINNING MARKET VALUE	NET CONTRIB	INCOME RECEIVED	GAIN (LOSS)	ENDING MARKET VALUE	TOTAL RETURN
12/00	33,578	0	0	-4,985	28,593	-14.9
3/01	28,593	0	0	-4,990	23,603	-17.4
6/01	23,603	0	0	1,479	25,082	6.3
9/01	25,082	0	0	-3,889	21,193	-15.5
12/01	21,193	0	0	3,222	24,415	15.2
3/02	24,415	0	0	-1,130	23,285	-4.6
6/02	23,285	2,000	1	-3,597	21,689	-14.9
9/02	21,689	4,750	9	-2,949	23,499	-15.0
12/02	23,499	250	6	413	24,168	1.8
3/03	24,168	4,500	0	-181	28,487	-1.1
6/03	28,487	0	0	3,620	32,107	12.7
9/03	32,107	0	0	1,262	33,369	3.9
12/03	33,369	-2,000	0	2,753	34,121	8.8
3/04	34,121	0	0	549	34,671	1.6
6/04	34,671	1,000	0	639	36,310	1.8
9/04	36,310	0	0	-2,084	34,225	-5.7
12/04	34,225	2,000	0	3,343	39,569	9.2
3/05	39,569	0	0	-2,453	37,116	-6.2
6/05	37,116	0	0	2,389	39,505	6.4
9/05	39,505	0	0	3,406	42,910	8.6

VERMONT MUNICIPAL EMPLOYEES

SOURCES OF PORTFOLIO GROWTH (\$000)

LAZARD SMALL CAP FUND

PERIOD ENDING	BEGINNING MARKET VALUE	NET CONTRIB	INCOME RECEIVED	GAIN (LOSS)	ENDING MARKET VALUE	TOTAL RETURN
12/00	14,003	0	0	843	14,846	6.0
3/01	14,846	0	0	-460	14,386	-2.9
6/01	14,386	-33	0	1,882	16,234	13.1
9/01	16,234	-30	13	-1,656	14,562	-10.1
12/01	14,562	-36	0	3,001	17,527	20.6
3/02	17,527	-33	0	1,252	18,746	7.2
6/02	18,746	-35	0	-1,699	17,012	-9.1
9/02	17,012	1,971	507	-3,827	15,664	-19.3
12/02	15,664	-31	0	804	16,437	5.1
3/03	16,437	969	0	-801	16,605	-4.9
6/03	16,605	466	0	3,103	20,174	18.4
9/03	20,174	-40	0	1,667	21,801	8.3
12/03	21,801	-2,041	0	2,914	22,675	14.7
3/04	22,675	-44	0	1,103	23,733	4.9
6/04	23,733	-43	0	480	24,171	1.7
9/04	24,171	-44	65	-722	23,469	-2.7
12/04	23,469	-46	4,130	-1,331	26,223	11.9
3/05	26,223	-2,049	0	-516	23,659	-1.8
6/05	23,659	1,957	0	482	26,098	2.0
9/05	26,098	-51	1,690	-416	27,322	4.9

VERMONT MUNICIPAL EMPLOYEES

SOURCES OF PORTFOLIO GROWTH (\$000)

BRINSON - UBS

PERIOD ENDING	BEGINNING MARKET VALUE	NET CONTRIB	INCOME RECEIVED	GAIN (LOSS)	ENDING MARKET VALUE	TOTAL RETURN
12/00	24,448	0	0	469	24,917	1.9
3/01	24,917	9,000	0	-2,923	30,994	-11.7
6/01	30,994	-12	4	638	31,624	2.1
9/01	31,624	0	0	-3,480	28,143	-11.0
12/01	28,143	0	0	2,158	30,301	7.7
3/02	30,301	0	0	1,006	31,307	3.3
6/02	31,307	2,000	0	-145	33,163	-0.3
9/02	33,163	3,000	0	-6,800	29,363	-20.3
12/02	29,363	0	1	2,620	31,984	8.9
3/03	31,984	-6,000	0	-2,502	23,482	-8.1
6/03	23,482	495	0	4,288	28,265	18.2
9/03	28,265	0	0	1,955	30,220	6.9
12/03	30,220	0	0	4,931	35,152	16.3
3/04	35,152	0	0	985	36,136	2.8
6/04	36,136	-6	0	-58	36,073	-0.2
9/04	36,073	0	0	566	36,639	1.6
12/04	36,639	0	0	5,249	41,888	14.3
3/05	41,888	-2,000	-4	-161	39,723	-0.4
6/05	39,723	0	0	-375	39,348	-1.0
9/05	39,348	0	0	3,531	42,880	9.0

VERMONT MUNICIPAL EMPLOYEES

SOURCES OF PORTFOLIO GROWTH (\$000)

MET LIFE / SSR TOWER FUND

PERIOD ENDING	BEGINNING MARKET VALUE	NET CONTRIB	INCOME RECEIVED	GAIN (LOSS)	ENDING MARKET VALUE	TOTAL RETURN
12/00	11,672	0	0	509	12,181	4.4
3/01	12,181	0	0	222	12,403	1.8
6/01	12,403	-2	0	228	12,628	1.8
9/01	12,628	0	0	70	12,698	0.6
12/01	12,698	-38	0	79	12,740	0.6
3/02	12,740	-38	0	4	12,705	0.0
6/02	12,705	-38	262	-147	12,782	0.9
9/02	12,782	-37	242	-189	12,799	0.4
12/02	12,799	18	218	-146	12,889	0.6
3/03	12,889	-31	226	2	13,086	1.8
6/03	13,086	-33	232	48	13,334	2.1
9/03	13,334	-34	0	321	13,621	2.4
12/03	13,621	-35	219	-144	13,660	0.6
3/04	13,660	-34	0	140	13,767	1.0
6/04	13,767	-35	0	393	14,125	2.9
9/04	14,125	-42	0	22	14,106	0.2
12/04	14,106	-42	0	340	14,404	2.4
3/05	14,404	1,958	0	641	17,003	4.4
6/05	17,003	-49	0	713	17,668	4.2
9/05	17,668	-50	0	942	18,559	5.3

VERMONT MUNICIPAL EMPLOYEES

SOURCES OF PORTFOLIO GROWTH (\$000)

SEIX CORE

PERIOD ENDING	BEGINNING MARKET VALUE	NET CONTRIB	INCOME RECEIVED	GAIN (LOSS)	ENDING MARKET VALUE	TOTAL RETURN
12/00	55,106	- 1	0	2,505	57,610	4.5
3/01	57,610	- 7,003	0	1,730	52,337	3.0
6/01	52,337	44	598	- 256	52,723	0.6
9/01	52,723	1	631	1,780	55,136	4.6
12/01	55,136	- 1	352	- 1,025	54,463	- 1.2
3/02	54,463	0	307	- 230	54,540	0.1
6/02	54,540	0	331	1,279	56,150	3.0
9/02	56,150	- 8,000	259	1,238	49,647	2.7
12/02	49,647	0	364	729	50,740	2.2
3/03	50,740	3,000	436	464	54,640	1.7
6/03	54,640	- 8,500	374	1,220	47,733	2.9
9/03	47,733	0	635	- 645	47,723	0.0
12/03	47,723	4,000	333	- 90	51,967	0.5
3/04	51,967	0	433	942	53,342	2.6
6/04	53,342	6,000	314	- 1,441	58,214	- 2.0
9/04	58,214	1,500	648	1,434	61,797	3.5
12/04	61,797	500	323	223	62,842	0.9
3/05	62,842	3,000	413	- 557	65,698	- 0.3
6/05	65,698	0	547	1,226	67,472	2.7
9/05	67,472	1,000	913	- 1,394	67,991	- 0.7

VERMONT MUNICIPAL EMPLOYEES

SOURCES OF PORTFOLIO GROWTH (\$000)

SEIX HIGH YIELD

PERIOD ENDING	BEGINNING MARKET VALUE	NET CONTRIB	INCOME RECEIVED	GAIN (LOSS)	ENDING MARKET VALUE	TOTAL RETURN
12/00						
3/01						
6/01						
9/01						
12/01						
3/02						
6/02						
9/02						
12/02						
3/03						
6/03		9,000		55	9,055	
9/03	9,055	-12	48	46	9,137	1.1
12/03	9,137	986	191	263	10,579	4.5
3/04	10,579	-15	169	71	10,804	2.3
6/04	10,804	-15	163	-321	10,632	-1.5
9/04	10,632	-15	181	347	11,145	5.0
12/04	11,145	-16	306	25	11,461	3.0
3/05	11,461	984	179	-356	12,269	-1.5
6/05	12,269	-17	193	153	12,598	2.8
9/05	12,598	-17	197	-98	12,681	0.8

VERMONT MUNICIPAL EMPLOYEES

SOURCES OF PORTFOLIO GROWTH (\$000)

ALTERNATIVE INVESTMENTS

PERIOD ENDING	BEGINNING MARKET VALUE	NET CONTRIB	INCOME RECEIVED	GAIN (LOSS)	ENDING MARKET VALUE	TOTAL RETURN
12/00	1,036	0	0	1	1,037	0.0
3/01	1,037	0	0	19	1,056	1.9
6/01	1,056	0	60	0	1,117	5.7
9/01	1,117	0	1	0	1,117	0.1
12/01	1,117	0	1	0	1,118	0.0
3/02	1,118	0	0	0	1,118	0.0
6/02	1,118	0	0	-232	887	-20.7
9/02	887	0	0	0	887	0.0
12/02	887	0	0	0	888	0.0
3/03	888	0	0	0	888	0.0
6/03	888	0	0	-59	829	-6.6
9/03	829	0	0	0	830	0.0
12/03	830	0	0	0	830	0.0
3/04	830	0	0	0	830	0.0
6/04	830	0	0	0	830	0.0
9/04	830	0	0	0	831	0.0
12/04	831	80	0	-171	740	-18.7
3/05	740	0	1	0	741	0.1
6/05	741	0	1	-109	632	-14.6
9/05	632	0	1	0	634	0.2

VERMONT MUNICIPAL EMPLOYEES

SOURCES OF PORTFOLIO GROWTH (\$000)

VERMONT INVESTMENTS

PERIOD ENDING	BEGINNING MARKET VALUE	NET CONTRIB	INCOME RECEIVED	GAIN (LOSS)	ENDING MARKET VALUE	TOTAL RETURN
12/00	2,044	366	0	63	2,473	2.1
3/01	2,473	-2,022	0	75	526	2.6
6/01	526	3,229	20	8	3,782	1.1
9/01	3,782	500	44	9	4,335	1.3
12/01	4,335	267	17	-1	4,619	0.4
3/02	4,619	1,206	41	-12	5,854	0.6
6/02	5,854	-3,071	17	25	2,825	0.9
9/02	2,825	-690	31	28	2,193	1.8
12/02	2,193	1,851	9	-2	4,050	0.1
3/03	4,050	-997	30	-54	3,030	-0.8
6/03	3,030	-2,685	1	5	351	0.6
9/03	351	750	0	7	1,108	1.3
12/03	1,108	2,447	16	-2	3,569	0.5
3/04	3,569	2,994	10	9	6,581	0.4
6/04	6,581	-5,267	71	-74	1,311	-0.3
9/04	1,311	-396	32	-20	926	0.8
12/04	926	-300	512	-494	645	1.1
3/05	645	500	20	5	1,170	1.8
6/05	1,170	-738	-488	494	438	0.5
9/05	438	360	20	-10	808	1.0

VERMONT MUNICIPAL EMPLOYEES

PORTFOLIO ASSET GROWTH BY SEGMENT (\$000)

QUARTER ENDING 9/05

<u>PORTFOLIO</u>	<u>BEGINNING VALUE</u>	<u>NET CONTR</u>	<u>INCOME RECEIVED</u>	<u>GAIN (LOSS)</u>	<u>END VALUE</u>
MUNI COMPOSITE	245,739	1,241	3,057	6,838	256,875
COMMON STOCK	107,265	225	1,925	3,867	113,281
INT'L C/S	39,340	0	0	3,531	42,871
BONDS	80,382	961	1,111	-1,490	80,964
CASH EQUIV	612	105	22	-12	728
REAL ESTATE	17,668	-50	0	942	18,559
PRIVATE INVEST	472	0	0	0	472
EQTY COMPOSITE	107,582	-51	1,925	3,867	113,323
COMMON STOCK	107,265	225	1,925	3,867	113,281
CASH EQUIV	317	-276	0	0	42
DELAWARE	41,980	0	234	877	43,091
COMMON STOCK	41,663	276	234	877	43,049
CASH EQUIV	317	-276	0	0	42
ALLIANCE	39,505	0	0	3,406	42,910
COMMON STOCK	39,505	0	0	3,406	42,910
LAZARD	26,098	-51	1,690	-416	27,322
COMMON STOCK	26,098	-51	1,690	-416	27,322

VERMONT MUNICIPAL EMPLOYEES

PORTFOLIO ASSET GROWTH BY SEGMENT (\$000)

QUARTER ENDING 9/05

<u>PORTFOLIO</u>	<u>BEGINNING VALUE</u>	<u>NET CONTR</u>	<u>INCOME RECEIVED</u>	<u>GAIN (LOSS)</u>	<u>END VALUE</u>
UBS	39,348	0	0	3,531	42,880
INT'L C/S	39,340	0	0	3,531	42,871
CASH EQUIV	8	0	0	0	8
SSR TOWER FUND	17,668	-50	0	942	18,559
REAL ESTATE	17,668	-50	0	942	18,559
SEIX CORE	67,472	1,000	913	-1,394	67,991
BONDS	67,472	1,000	913	-1,394	67,991
SEIX HIGH YIELD	12,598	-17	197	-98	12,681
BONDS	12,598	-17	197	-98	12,681
ALT. ASSETS	632	0	1	0	634
CASH EQUIV	160	0	1	0	162
PRIVATE INVEST	472	0	0	0	472
VERMONT INVEST	438	360	20	-10	808
BONDS	312	-21	0	2	292
CASH EQUIV	127	381	20	-12	516

VERMONT MUNICIPAL EMPLOYEES

PORTFOLIO ASSET GROWTH BY SEGMENT (\$000)

YEAR TO DATE

<u>PORTFOLIO</u>	<u>BEGINNING VALUE</u>	<u>NET CONTR</u>	<u>INCOME RECEIVED</u>	<u>GAIN (LOSS)</u>	<u>END VALUE</u>
MUNI COMPOSITE	239,747	4,788	4,379	7,961	256,875
COMMON STOCK	107,767	-184	2,384	3,315	113,281
INT'L C/S	41,880	-2,000	0	2,991	42,871
BONDS	74,617	4,929	2,443	-1,025	80,964
CASH EQUIV	498	185	-448	494	728
REAL ESTATE	14,404	1,859	0	2,296	18,559
PRIVATE INVEST	582	0	0	-109	472
EQTY COMPOSITE	107,767	-143	2,384	3,315	113,323
COMMON STOCK	107,767	-184	2,384	3,315	113,281
CASH EQUIV	0	41	0	0	42
DELAWARE	41,975	0	694	422	43,091
COMMON STOCK	41,975	-41	694	422	43,049
CASH EQUIV	0	41	0	0	42
ALLIANCE	39,569	0	0	3,341	42,910
COMMON STOCK	39,569	0	0	3,341	42,910
LAZARD	26,223	-143	1,690	-449	27,322
COMMON STOCK	26,223	-143	1,690	-449	27,322

VERMONT MUNICIPAL EMPLOYEES

PORTFOLIO ASSET GROWTH BY SEGMENT (\$000)

YEAR TO DATE

<u>PORTFOLIO</u>	<u>BEGINNING VALUE</u>	<u>NET CONTR</u>	<u>INCOME RECEIVED</u>	<u>GAIN (LOSS)</u>	<u>END VALUE</u>
UBS	41,888	- 2,000	- 4	2,995	42,880
INT'L C/S	41,880	- 2,000	0	2,991	42,871
CASH EQUIV	8	0	- 4	4	8
SSR TOWER FUND	14,404	1,859	0	2,296	18,559
REAL ESTATE	14,404	1,859	0	2,296	18,559
SEIX CORE	62,842	4,000	1,873	- 724	67,991
BONDS	62,842	4,000	1,873	- 724	67,991
SEIX HIGH YIELD	11,461	950	570	- 300	12,681
BONDS	11,461	950	570	- 300	12,681
ALT. ASSETS	740	0	3	- 109	634
CASH EQUIV	158	0	3	0	162
PRIVATE INVEST	582	0	0	- 109	472
VERMONT INVEST	645	122	- 448	489	808
BONDS	313	- 21	0	0	292
CASH EQUIV	331	143	- 448	489	516

VERMONT MUNICIPAL EMPLOYEES

PORTFOLIO ASSET GROWTH BY SEGMENT (\$000)

YEAR ENDING 9/05

<u>PORTFOLIO</u>	<u>BEGINNING VALUE</u>	<u>NET CONTR</u>	<u>INCOME RECEIVED</u>	<u>GAIN (LOSS)</u>	<u>END VALUE</u>
MUNI COMPOSITE	221,740	6,965	9,857	18,313	256,875
COMMON STOCK	96,296	1,770	6,721	8,494	113,281
INT'L C/S	36,631	-2,000	0	8,240	42,871
BONDS	73,251	5,413	3,072	-772	80,964
CASH EQUIV	703	-35	64	-4	728
REAL ESTATE	14,106	1,817	0	2,636	18,559
PRIVATE INVEST	753	0	0	-280	472
EQTY COMPOSITE	96,296	1,812	6,721	8,495	113,323
COMMON STOCK	96,296	1,770	6,721	8,494	113,281
CASH EQUIV	0	41	0	0	42
DELAWARE	38,601	0	900	3,589	43,091
COMMON STOCK	38,601	-41	900	3,589	43,049
CASH EQUIV	0	41	0	0	42
ALLIANCE	34,225	2,000	0	6,685	42,910
COMMON STOCK	34,225	2,000	0	6,685	42,910
LAZARD	23,469	-188	5,820	-1,780	27,322
COMMON STOCK	23,469	-188	5,820	-1,780	27,322

VERMONT MUNICIPAL EMPLOYEES

PORTFOLIO ASSET GROWTH BY SEGMENT (\$000)

YEAR ENDING 9/05

<u>PORTFOLIO</u>	<u>BEGINNING VALUE</u>	<u>NET CONTR</u>	<u>INCOME RECEIVED</u>	<u>GAIN (LOSS)</u>	<u>END VALUE</u>
UBS	36,639	- 2,000	- 4	8,244	42,880
INT'L C/S	36,631	- 2,000	0	8,240	42,871
CASH EQUIV	8	0	- 4	4	8
SSR TOWER FUND	14,106	1,817	0	2,636	18,559
REAL ESTATE	14,106	1,817	0	2,636	18,559
SEIX CORE	61,797	4,500	2,196	- 502	67,991
BONDS	61,797	4,500	2,196	- 502	67,991
SEIX HIGH YIELD	11,145	934	876	- 275	12,681
BONDS	11,145	934	876	- 275	12,681
ALT. ASSETS	831	80	3	- 280	634
CASH EQUIV	78	80	3	0	162
PRIVATE INVEST	753	0	0	- 280	472
VERMONT INVEST	926	- 178	64	- 5	808
BONDS	309	- 21	0	4	292
CASH EQUIV	617	- 157	64	- 9	516

VERMONT MUNICIPAL EMPLOYEES
PERFORMANCE ANALYSIS
MUNICIPAL SYSTEM COMPOSITE

PERIODS ENDING 9/05

	<u>LAST QTR</u>		<u>LAST 2 QTRS</u>		<u>LAST 3 QTRS</u>		<u>LAST YEAR</u>		<u>LAST 3 YEARS</u>		<u>LAST 5 YEARS</u>	
TOTAL FUND	4.0	40	6.5	34	5.0	44	12.5	55	13.4	60	5.3	33
ALLOCATION IDX	3.6	51	6.0	48	4.7	51	13.1	45	14.6	39	3.7	66
MEDIAN	3.7		5.9		4.8		12.8		14.1		4.4	
EQUITIES	5.4	36	8.9	33	5.4	46	15.6	58	17.1	70	2.7	50
S&P 500	3.6	71	5.0	77	2.8	77	12.3	81	16.7	79	- 1.5	77
R 1000(R) GR	4.0	59	6.6	54	2.2	84	11.6	87	14.7	89	- 8.6	97
R 1000(R) VALUE	3.9	61	5.6	68	5.7	43	16.7	52	20.5	48	5.8	39
R 2000(R)	4.7	47	9.2	31	3.4	66	18.0	45	24.1	23	6.4	35
MEDIAN	4.5		7.2		5.1		17.1		20.3		2.7	
BONDS	- 0.5	67	2.2	65	1.8	61	3.1	55	5.2	37	6.7	60
LB AGGREGATE	- 0.7	82	2.3	58	1.8	60	2.8	64	4.0	66	6.6	64
ML HIGH YLD II	0.9	8	3.6	10	2.1	46	6.7	5	15.7	1	7.2	42
MEDIAN	- 0.4		2.4		2.0		3.2		4.7		7.0	
INT'L EQUITIES	9.0	77	7.9	77	7.5	78	22.9	78	23.5	72		
MS EAFE NET	10.4	58	9.3	61	9.1	68	25.8	62	24.6	66	3.2	81
CITI PMI EPAC	11.0	51	10.3	49	10.2	56	27.3	47	25.1	58	3.5	77
MEDIAN	11.0		10.1		10.8		26.9		25.8		7.4	

VERMONT MUNICIPAL EMPLOYEES
PERFORMANCE ANALYSIS
MUNI POLICY INDEX

PERIODS ENDING 9/05

	<u>LAST QTR</u>		<u>LAST 2 QTRS</u>		<u>LAST 3 QTRS</u>		<u>LAST YEAR</u>		<u>LAST 3 YEARS</u>		<u>LAST 5 YEARS</u>	
TOTAL FUND	3.7	49	6.0	46	4.9	47	12.8	48	14.8	36	4.2	56
MEDIAN	3.7		5.9		4.8		12.8		14.1		4.4	

VERMONT MUNICIPAL EMPLOYEES
PERFORMANCE ANALYSIS
DOMESTIC EQUITY COMPOSITE

PERIODS ENDING 9/05

	<u>LAST QTR</u>		<u>LAST 2 QTRS</u>		<u>LAST 3 QTRS</u>		<u>LAST YEAR</u>		<u>LAST 3 YEARS</u>		<u>LAST 5 YEARS</u>	
TOTAL FUND	5.4	34	8.9	32	5.4	46	15.6	57	17.0	70	2.7	51
ALLOCATION IDX	4.1	54	6.8	52	3.8	62	15.1	59	18.8	58	- 0.8	66
MEDIAN	4.4		7.1		5.0		16.8		20.1		3.1	
EQUITIES	5.4	36	8.9	33	5.4	46	15.6	58	17.1	70	2.7	50
S&P 500	3.6	71	5.0	77	2.8	77	12.3	81	16.7	79	- 1.5	77
R 1000(R) GR	4.0	59	6.6	54	2.2	84	11.6	87	14.7	89	- 8.6	97
R 1000(R) VALUE	3.9	61	5.6	68	5.7	43	16.7	52	20.5	48	5.8	39
R 2000(R)	4.7	47	9.2	31	3.4	66	18.0	45	24.1	23	6.4	35
MEDIAN	4.5		7.2		5.1		17.1		20.3		2.7	

VERMONT MUNICIPAL EMPLOYEES
PERFORMANCE ANALYSIS
DELAWARE

PERIODS ENDING 9/05

	<u>LAST QTR</u>		<u>LAST 2 QTRS</u>		<u>LAST 3 QTRS</u>		<u>LAST YEAR</u>		<u>LAST 3 YEARS</u>		<u>LAST 5 YEARS</u>	
TOTAL FUND	2.6	85	4.0	88	2.7	79	11.6	86	17.0	70	6.1	39
ALLOCATION IDX	3.9	61	5.6	67	5.7	42	16.7	50	20.7	44	2.7	51
MEDIAN	4.4		7.1		5.0		16.8		20.1		3.1	
EQUITIES	2.7	86	4.0	88	2.7	79	11.7	87	17.0	71	6.1	37
S&P 500	3.6	71	5.0	77	2.8	77	12.3	81	16.7	79	- 1.5	77
R 1000(R) GR	4.0	59	6.6	54	2.2	84	11.6	87	14.7	89	- 8.6	97
R 1000(R) VALUE	3.9	61	5.6	68	5.7	43	16.7	52	20.5	48	5.8	39
R 2000(R)	4.7	47	9.2	31	3.4	66	18.0	45	24.1	23	6.4	35
MEDIAN	4.5		7.2		5.1		17.1		20.3		2.7	

VERMONT MUNICIPAL EMPLOYEES
PERFORMANCE ANALYSIS
ALLIANCE LARGE CAP GROWTH FUND

PERIODS ENDING 9/05

	LAST QTR		LAST 2 QTRS		LAST 3 QTRS		LAST YEAR		LAST 3 YEARS		LAST 5 YEARS	
TOTAL FUND	8.6	6	15.6	2	8.4	19	18.5	39	14.0	90	- 5.7	92
ALLOCATION IDX	4.0	57	6.6	54	2.2	84	11.6	86	13.7	91	- 8.7	97
MEDIAN	4.4		7.1		5.0		16.8		20.1		3.1	
EQUITIES	8.6	7	15.6	3	8.4	20	18.5	41	14.3	90	- 5.8	92
S&P 500	3.6	71	5.0	77	2.8	77	12.3	81	16.7	79	- 1.5	77
R 1000(R) GR	4.0	59	6.6	54	2.2	84	11.6	87	14.7	89	- 8.6	97
R 1000(R) VALUE	3.9	61	5.6	68	5.7	43	16.7	52	20.5	48	5.8	39
R 2000(R)	4.7	47	9.2	31	3.4	66	18.0	45	24.1	23	6.4	35
MEDIAN	4.5		7.2		5.1		17.1		20.3		2.7	

VERMONT MUNICIPAL EMPLOYEES
PERFORMANCE ANALYSIS
LAZARD SMALL CAP FUND

PERIODS ENDING 9/05

	<u>LAST QTR</u>		<u>LAST 2 QTRS</u>		<u>LAST 3 QTRS</u>		<u>LAST YEAR</u>		<u>LAST 3 YEARS</u>		<u>LAST 5 YEARS</u>	
TOTAL FUND	4.9	42	7.0	50	5.0	50	17.5	46	21.5	38	12.2	19
ALLOCATION IDX	4.7	46	9.2	30	3.4	66	18.0	43	24.1	20	6.4	38
MEDIAN	4.4		7.1		5.0		16.8		20.1		3.1	
EQUITIES	4.9	43	7.0	51	5.0	50	17.5	47	21.5	40	12.2	19
S&P 500	3.6	71	5.0	77	2.8	77	12.3	81	16.7	79	- 1.5	77
R 1000(R) GR	4.0	59	6.6	54	2.2	84	11.6	87	14.7	89	- 8.6	97
R 1000(R) VALUE	3.9	61	5.6	68	5.7	43	16.7	52	20.5	48	5.8	39
R 2000(R)	4.7	47	9.2	31	3.4	66	18.0	45	24.1	23	6.4	35
MEDIAN	4.5		7.2		5.1		17.1		20.3		2.7	

VERMONT MUNICIPAL EMPLOYEES
PERFORMANCE ANALYSIS
SEIX CORE

PERIODS ENDING 9/05

	<u>LAST QTR</u>		<u>LAST 2 QTRS</u>		<u>LAST 3 QTRS</u>		<u>LAST YEAR</u>		<u>LAST 3 YEARS</u>		<u>LAST 5 YEARS</u>	
TOTAL FUND	- 0.7	89	2.0	77	1.7	72	2.6	73	4.7	49	6.3	70
ALLOCATION IDX	- 0.7	85	2.3	58	1.8	65	2.8	67	4.0	66	6.6	62
MEDIAN	- 0.3		2.4		2.1		3.3		4.7		6.9	
BONDS	- 0.7	86	2.0	77	1.7	66	2.6	70	4.7	49	6.4	71
LB AGGREGATE	- 0.7	82	2.3	58	1.8	60	2.8	64	4.0	66	6.6	64
ML HIGH YLD II	0.9	8	3.6	10	2.1	46	6.7	5	15.7	1	7.2	42
MEDIAN	- 0.4		2.4		2.0		3.2		4.7		7.0	

VERMONT MUNICIPAL EMPLOYEES
PERFORMANCE ANALYSIS
SEIX HIGH YIELD

PERIODS ENDING 9/05

	LAST QTR		LAST 2 QTRS		LAST 3 QTRS		LAST YEAR		LAST 3 YEARS		LAST 5 YEARS	
TOTAL FUND	0.8	14	3.6	8	2.1	51	5.1	15				
ALLOCATION IDX	0.8	14	3.4	14	2.1	49	5.9	8				
MEDIAN	-0.3		2.4		2.1		3.3		4.7		6.9	
BONDS	0.8	11	3.6	8	2.1	47	5.1	14				
LB AGGREGATE	-0.7	82	2.3	58	1.8	60	2.8	64	4.0	66	6.6	64
ML HIGH YLD II	0.9	8	3.6	10	2.1	46	6.7	5	15.7	1	7.2	42
MEDIAN	-0.4		2.4		2.0		3.2		4.7		7.0	

VERMONT MUNICIPAL EMPLOYEES
PERFORMANCE ANALYSIS
VERMONT INVESTMENTS

PERIODS ENDING 9/05

	<u>LAST QTR</u>		<u>LAST 2 QTRS</u>		<u>LAST 3 QTRS</u>		<u>LAST YEAR</u>		<u>LAST 3 YEARS</u>		<u>LAST 5 YEARS</u>	
TOTAL FUND	1.0	13	1.5	65	3.3	7	4.4	8	2.3	16	3.5	13
ALLOCATION IDX	0.0	97	1.1	88	1.7	82	2.3	69	1.7	46	2.8	29
MEDIAN	0.8		1.5		2.1		2.6		1.7		2.5	
CASH EQUIV.	1.1	7	1.8	9	3.8	3	4.8	4	2.2	11		
MEDIAN	0.8		1.5		2.1		2.6		1.6		2.5	
BONDS	0.5	15	-1.1	99	0.0	98	1.3	96	0.8	99		
LB AGGREGATE	-0.7	82	2.3	58	1.8	60	2.8	64	4.0	66	6.6	64
ML HIGH YLD II	0.9	8	3.6	10	2.1	46	6.7	5	15.7	1	7.2	42
MEDIAN	-0.4		2.4		2.0		3.2		4.7		7.0	

VERMONT MUNICIPAL EMPLOYEES
REAL ESTATE SEGMENT RATES OF RETURN
PERIODS ENDING 9/05

		ASSETS AT MKT \$MM	PCT OF ACCT	LAST QTR	LAST 2 QTRS	LAST 3 QTRS	LAST YEAR	LAST 3 YEARS	LAST 5 YEARS
MUNICIPAL SYSTEM COMPOSITE	INCOME			0.0	0.0	0.0	0.0	2.3	2.2
	APPRECIATION			5.3	9.8	14.6	17.4	7.3	5.7
	TOTAL	18.6	7.2	5.3	9.8	14.6	17.4	9.6	7.9
MET LIFE / SSR TOWER FUND	INCOME			0.0	0.0	0.0	0.0	2.3	2.2
	APPRECIATION			5.3	9.8	14.6	17.4	7.3	5.7
	TOTAL	18.6	100.0	5.3	9.8	14.6	17.4	9.6	7.9

VERMONT MUNICIPAL EMPLOYEES

PERFORMANCE HISTORY

MUNICIPAL SYSTEM COMPOSITE

QUARTER ENDING	TOTAL FUND	ALLOC INDEX	EQUITY SEGMENT	S&P 500 INDEX	BOND SEGMENT	LEHMN AGG INDX	CASH SEGMENT	91-DAY T-BILL
12/ 95	4. 5	4. 6						
03/ 96	2. 4	2. 9						
06/ 96	3. 6	2. 5	3. 2	4. 5	0. 4	0. 6		
09/ 96	2. 8	1. 9	3. 6	3. 1	2. 1	1. 8		
ANNUAL	14. 0	12. 5						
12/ 96	6. 3	4. 9	9. 6	8. 3	3. 5	3. 0		
03/ 97	0. 3	0. 4	0. 8	2. 7	- 0. 1	- 0. 6		
06/ 97	10. 4	11. 6	17. 7	17. 5	3. 7	3. 7		
09/ 97	7. 0	5. 1	11. 3	7. 5	3. 4	3. 3		
ANNUAL	25. 8	23. 5	44. 6	40. 4	10. 8	9. 7		
12/ 97	0. 6	0. 3	0. 6	2. 9	2. 0	2. 9		
03/ 98	10. 1	10. 5	16. 5	13. 9	- 1. 5	1. 5		
06/ 98	2. 2	2. 4	3. 2	3. 3	1. 8	2. 3		
09/ 98	- 4. 2	- 5. 9	- 12. 2	- 9. 9	5. 4	4. 2		
ANNUAL	8. 4	6. 7	6. 1	9. 0	7. 9	11. 5		
12/ 98	13. 2	14. 0	22. 0	21. 3	2. 6	0. 3		
03/ 99	2. 7	2. 4	6. 1	5. 0	- 1. 5	- 0. 5		
06/ 99	2. 6	3. 3	5. 5	7. 0	- 1. 3	- 0. 9		
09/ 99	- 2. 7	- 1. 7	- 7. 7	- 6. 2	0. 6	0. 7		
ANNUAL	16. 0	18. 5	26. 1	27. 8	0. 3	- 0. 4		
12/ 99	6. 9	10. 7	10. 9	14. 9	- 0. 5	- 0. 1		
03/ 00	1. 4	5. 0	1. 9	2. 3	2. 4	2. 2		
06/ 00	0. 4	- 1. 3	- 1. 6	- 2. 7	1. 8	1. 7		
09/ 00	0. 5	0. 3	1. 0	- 1. 0	3. 3	3. 0		
ANNUAL	9. 3	15. 1	12. 3	13. 3	7. 1	7. 0		

VERMONT MUNICIPAL EMPLOYEES

PERFORMANCE HISTORY

MUNICIPAL SYSTEM COMPOSITE

<u>QUARTER ENDING</u>	<u>INT'L C/S</u>	<u>INT'L BOND</u>	<u>CONV</u>	<u>MORT</u>	<u>REAL ESTATE</u>	<u>SV ASSETS</u>	<u>PRVT INVEST</u>	<u>MISC</u>
12/ 95								4.5
03/ 96								2.4
06/ 96					1.1		3.1	
09/ 96					2.2		-1.3	
ANNUAL								
12/ 96					2.2		0.0	
03/ 97					2.0		1.3	
06/ 97					2.2		-2.0	
09/ 97					3.1		1.6	
ANNUAL					9.8		1.0	
12/ 97					3.0		-1.0	
03/ 98					3.6		0.0	
06/ 98					3.1		0.0	
09/ 98					3.4		0.0	
ANNUAL					13.7		-0.9	
12/ 98					3.2		0.0	
03/ 99					2.3		0.0	
06/ 99					3.2		11.2	
09/ 99					2.5		0.0	
ANNUAL					11.7		11.2	
12/ 99					2.9		0.0	
03/ 00					2.8		0.0	
06/ 00					2.3		53.7	
09/ 00					2.8		0.0	
ANNUAL					11.3		53.8	

VERMONT MUNICIPAL EMPLOYEES

PERFORMANCE HISTORY

MUNICIPAL SYSTEM COMPOSITE

QUARTER ENDING	TOTAL FUND	ALLOC INDEX	EQUITY SEGMENT	S&P 500 INDEX	BOND SEGMENT	LEHMN AGG INDX	CASH SEGMENT	91-DAY T-BILL
12/ 00	1.2	-3.2	-2.1	-7.8	4.5	4.2		
03/ 01	-4.4	-6.3	-9.1	-11.9	3.0	3.0		
06/ 01	3.5	3.5	6.7	5.9	0.7	0.6	1.1	1.1
09/ 01	-5.7	-8.8	-12.6	-14.7	4.6	4.6	0.9	1.1
ANNUAL	-5.5	-14.3	-16.9	-26.6	13.4	13.0		
12/ 01	6.1	6.6	13.7	10.7	-1.2	0.0	0.5	0.6
03/ 02	1.6	0.4	2.4	0.3	0.1	0.1	0.5	0.4
06/ 02	-3.5	-4.2	-10.5	-13.4	3.1	3.7	0.4	0.5
09/ 02	-9.7	-9.4	-17.8	-17.3	2.7	4.6	0.5	0.5
ANNUAL	-5.9	-7.1	-14.3	-20.5	4.8	8.6	1.8	2.0
12/ 02	4.3	4.6	5.2	8.4	2.2	1.6	0.3	0.4
03/ 03	-2.3	-2.2	-3.6	-3.1	1.6	1.4	0.3	0.3
06/ 03	10.7	11.3	16.1	15.4	3.0	2.5	0.2	0.3
09/ 03	3.3	3.5	4.4	2.6	0.2	-0.1	0.3	0.2
ANNUAL	16.6	17.8	22.9	24.4	7.1	5.4	1.1	1.3
12/ 03	8.1	9.2	11.8	12.2	1.1	0.3	0.2	0.3
03/ 04	2.4	3.0	2.5	1.7	2.6	2.7	0.3	0.2
06/ 04	0.4	0.1	1.9	1.7	-1.9	-2.4	0.1	0.2
09/ 04	0.0	0.3	-3.2	-1.9	3.8	3.2	0.3	0.4
ANNUAL	11.1	12.9	12.9	13.9	5.6	3.7	0.9	1.1
12/ 04	7.1	8.0	9.7	9.2	1.2	1.0	0.9	0.5
03/ 05	-1.4	-1.2	-3.3	-2.1	-0.4	-0.5	1.6	0.6
06/ 05	2.4	2.3	3.3	1.4	2.7	3.0	0.7	0.7
09/ 05	4.0	3.6	5.4	3.6	-0.5	-0.7	1.1	0.8
ANNUAL	12.5	13.1	15.6	12.3	3.1	2.8	4.4	2.6
HISTORICAL CUMULATIVE	155.6	142.3	165.4	121.7	82.1	84.1	10.6	9.6
ANNUAL EQUIVALENT	9.8	9.3	10.8	8.7	6.5	6.6	2.3	2.1

VERMONT MUNICIPAL EMPLOYEES

PERFORMANCE HISTORY

MUNICIPAL SYSTEM COMPOSITE

<u>QUARTER ENDING</u>	<u>INT'L C/S</u>	<u>INT'L BOND</u>	<u>CONV</u>	<u>MORT</u>	<u>REAL ESTATE</u>	<u>SV ASSETS</u>	<u>PRVT INVEST</u>	<u>MISC</u>
12/ 00					4. 4		0. 0	
03/ 01					1. 8		1. 9	
06/ 01	2. 1				1. 8		5. 9	
09/ 01	- 11. 0				0. 6		0. 0	
ANNUAL					8. 8		7. 9	
12/ 01	7. 7				0. 6		0. 0	
03/ 02	3. 3				0. 0		0. 0	
06/ 02	- 0. 3				0. 9		- 22. 2	
09/ 02	- 20. 3				0. 4		0. 0	
ANNUAL	- 11. 6				2. 0		- 22. 2	
12/ 02	8. 9				0. 6		0. 0	
03/ 03	- 8. 1				1. 8		0. 0	
06/ 03	18. 2				2. 1		- 7. 2	
09/ 03	6. 9				2. 4		0. 0	
ANNUAL	26. 5				7. 1		- 7. 2	
12/ 03	16. 3				0. 6		0. 0	
03/ 04	2. 8				1. 0		0. 0	
06/ 04	- 0. 2				2. 9		0. 0	
09/ 04	1. 6				0. 2		0. 0	
ANNUAL	21. 3				4. 7		0. 0	
12/ 04	14. 3				2. 4		- 22. 7	
03/ 05	- 0. 4				4. 4		0. 0	
06/ 05	- 1. 0				4. 2		- 18. 8	
09/ 05	9. 0				5. 3		0. 0	
ANNUAL	22. 9				17. 4		- 37. 3	
HISTORICAL CUMULATIVE	51. 5				134. 0		- 14. 9	
ANNUAL EQUIVALENT	9. 7				9. 4		- 1. 7	

VERMONT MUNICIPAL EMPLOYEES

PERFORMANCE HISTORY

MUNI POLICY INDEX

<u>QUARTER ENDING</u>	<u>TOTAL FUND</u>	<u>ALLOC INDEX</u>	<u>EQUITY SEGMENT</u>	<u>S&P 500 INDEX</u>	<u>BOND SEGMENT</u>	<u>LEHMN AGG INDX</u>	<u>CASH SEGMENT</u>	<u>91-DAY T-BILL</u>
12/ 95	4. 5							
03/ 96	2. 0							
06/ 96	2. 7							
09/ 96	2. 6							
ANNUAL	12. 4							
12/ 96	5. 4							
03/ 97	1. 0							
06/ 97	10. 6							
09/ 97	5. 0							
ANNUAL	23. 5							
12/ 97	2. 1							
03/ 98	8. 4							
06/ 98	2. 9							
09/ 98	- 4. 2							
ANNUAL	9. 1							
12/ 98	12. 3							
03/ 99	2. 5							
06/ 99	3. 4							
09/ 99	- 1. 6							
ANNUAL	17. 1							
12/ 99	8. 9							
03/ 00	2. 1							
06/ 00	- 0. 8							
09/ 00	- 0. 2							
ANNUAL	10. 1							

VERMONT MUNICIPAL EMPLOYEES

PERFORMANCE HISTORY

MUNI POLICY INDEX

QUARTER ENDING	TOTAL FUND	ALLOC INDEX	EQUITY SEGMENT	S&P 500 INDEX	BOND SEGMENT	LEHMN AGG INDX	CASH SEGMENT	91-DAY T-BILL
12/ 00	- 2. 1							
03/ 01	- 6. 2							
06/ 01	3. 7							
09/ 01	- 8. 3							
ANNUAL	- 12. 7							
12/ 01	7. 0							
03/ 02	1. 0							
06/ 02	- 4. 4							
09/ 02	- 10. 2							
ANNUAL	- 7. 2							
12/ 02	5. 2							
03/ 03	- 2. 0							
06/ 03	11. 4							
09/ 03	3. 5							
ANNUAL	18. 9							
12/ 03	8. 8							
03/ 04	3. 0							
06/ 04	0. 1							
09/ 04	0. 5							
ANNUAL	12. 8							
12/ 04	7. 6							
03/ 05	- 1. 1							
06/ 05	2. 2							
09/ 05	3. 7							
ANNUAL	12. 8							
HISTORICAL CUMULATIVE	139. 6							
ANNUAL EQUIVALENT	9. 1							

VERMONT MUNICIPAL EMPLOYEES

PERFORMANCE HISTORY

DOMESTIC EQUITY COMPOSITE

QUARTER ENDING	TOTAL FUND	ALLOC INDEX	EQUITY SEGMENT	S&P 500 INDEX	BOND SEGMENT	LEHMN AGG INDX	CASH SEGMENT	91-DAY T-BILL
12/ 95								
03/ 96								
06/ 96	3. 2	4. 0	3. 2	4. 5				
09/ 96	3. 6	3. 1	3. 6	3. 1				
ANNUAL								
12/ 96	9. 6	7. 9	9. 6	8. 3				
03/ 97	0. 8	1. 2	0. 8	2. 7				
06/ 97	17. 7	16. 5	17. 7	17. 5				
09/ 97	11. 3	8. 4	11. 3	7. 5				
ANNUAL	44. 6	37. 9	44. 6	40. 4				
12/ 97	0. 6	1. 9	0. 6	2. 9				
03/ 98	16. 5	13. 2	16. 5	13. 9				
06/ 98	3. 2	2. 7	3. 2	3. 3				
09/ 98	- 12. 2	- 11. 0	- 12. 2	- 9. 9				
ANNUAL	6. 1	5. 4	6. 1	9. 0				
12/ 98	22. 0	22. 4	22. 0	21. 3				
03/ 99	6. 1	4. 7	6. 1	5. 0				
06/ 99	5. 5	6. 9	5. 5	7. 0				
09/ 99	- 7. 7	- 6. 3	- 7. 7	- 6. 2				
ANNUAL	26. 1	28. 4	26. 1	27. 8				
12/ 99	10. 9	18. 0	10. 9	14. 9				
03/ 00	1. 9	5. 3	1. 9	2. 3				
06/ 00	- 1. 6	- 3. 2	- 1. 6	- 2. 7				
09/ 00	1. 0	0. 7	1. 0	- 1. 0				
ANNUAL	12. 3	21. 1	12. 3	13. 3				

VERMONT MUNICIPAL EMPLOYEES

PERFORMANCE HISTORY

DOMESTIC EQUITY COMPOSITE

QUARTER ENDING	TOTAL FUND	ALLOC INDEX	EQUITY SEGMENT	S&P 500 INDEX	BOND SEGMENT	LEHMN AGG INDX	CASH SEGMENT	91-DAY T-BILL
12/ 00	- 2. 1	- 9. 8	- 2. 1	- 7. 8				
03/ 01	- 9. 1	- 11. 7	- 9. 1	- 11. 9				
06/ 01	6. 7	8. 0	6. 7	5. 9				
09/ 01	- 12. 6	- 18. 4	- 12. 6	- 14. 7			0. 7	1. 1
ANNUAL	- 16. 9	- 29. 8	- 16. 9	- 26. 6				
12/ 01	13. 7	13. 5	13. 7	10. 7			0. 7	0. 6
03/ 02	2. 4	0. 7	2. 4	0. 3			0. 4	0. 4
06/ 02	- 10. 4	- 12. 5	- 10. 5	- 13. 4			0. 5	0. 5
09/ 02	- 17. 6	- 18. 4	- 17. 8	- 17. 3			0. 5	0. 5
ANNUAL	- 14. 0	- 18. 3	- 14. 3	- 20. 5			2. 2	2. 0
12/ 02	4. 9	6. 7	5. 2	8. 4			0. 4	0. 4
03/ 03	- 3. 6	- 3. 3	- 3. 6	- 3. 1				
06/ 03	16. 1	17. 5	16. 1	15. 4				
09/ 03	4. 4	4. 4	4. 4	2. 6				
ANNUAL	22. 6	26. 5	22. 9	24. 4				
12/ 03	11. 8	12. 9	11. 8	12. 2				
03/ 04	2. 5	3. 0	2. 5	1. 7				
06/ 04	1. 9	1. 2	1. 9	1. 7				
09/ 04	- 3. 2	- 2. 0	- 3. 2	- 1. 9				
ANNUAL	12. 9	15. 3	12. 9	13. 9				
12/ 04	9. 7	10. 8	9. 7	9. 2				
03/ 05	- 3. 3	- 2. 8	- 3. 3	- 2. 1				
06/ 05	3. 3	2. 6	3. 3	1. 4			0. 0	0. 7
09/ 05	5. 4	4. 1	5. 4	3. 6			0. 3	0. 8
ANNUAL	15. 6	15. 1	15. 6	12. 3				
HISTORICAL CUMULATIVE	165. 7	133. 4	165. 4	121. 7			0. 3	1. 6
ANNUAL EQUIVALENT	10. 8	9. 3	10. 8	8. 7			0. 3	1. 6

VERMONT MUNICIPAL EMPLOYEES

PERFORMANCE HISTORY

DELAWARE

QUARTER ENDING	TOTAL FUND	ALLOC INDEX	EQUITY SEGMENT	S&P 500 INDEX	BOND SEGMENT	LEHMN AGG INDX	CASH SEGMENT	91-DAY T-BILL
12/ 95	6. 7	6. 5	6. 7	6. 0				
03/ 96	5. 3	6. 4	5. 3	5. 4				
06/ 96	2. 7	2. 0	2. 7	4. 5				
09/ 96	4. 0	2. 6	4. 0	3. 1				
ANNUAL	20. 1	18. 7	20. 1	20. 3				
12/ 96	8. 4	9. 5	8. 4	8. 3				
03/ 97	2. 4	1. 8	2. 4	2. 7				
06/ 97	15. 7	14. 5	15. 7	17. 5				
09/ 97	9. 0	9. 2	9. 0	7. 5				
ANNUAL	40. 1	39. 2	40. 1	40. 4				
12/ 97	2. 5	2. 2	2. 5	2. 9				
03/ 98	11. 5	11. 6	11. 5	13. 9				
06/ 98	- 0. 8	0. 5	- 0. 8	3. 3				
09/ 98	- 12. 0	- 12. 9	- 12. 0	- 9. 9				
ANNUAL	- 0. 3	- 0. 2	- 0. 3	9. 0				
12/ 98	14. 0	17. 4	14. 0	21. 3				
03/ 99	- 0. 3	2. 9	- 0. 3	5. 0				
06/ 99	6. 7	10. 8	6. 7	7. 0				
09/ 99	- 9. 6	- 9. 2	- 9. 6	- 6. 2				
ANNUAL	9. 6	21. 5	9. 6	27. 8				
12/ 99	3. 5	9. 0	3. 5	14. 9				
03/ 00	- 5. 3	0. 2	- 5. 3	2. 3				
06/ 00	0. 1	- 4. 3	0. 1	- 2. 7				
09/ 00	8. 7	8. 8	8. 7	- 1. 0				
ANNUAL	6. 6	13. 7	6. 6	13. 3				

VERMONT MUNICIPAL EMPLOYEES

PERFORMANCE HISTORY

DELAWARE

QUARTER ENDING	TOTAL FUND	ALLOC INDEX	EQUITY SEGMENT	S&P 500 INDEX	BOND SEGMENT	LEHMN AGG INDX	CASH SEGMENT	91-DAY T-BILL
12/ 00	10. 0	1. 6	10. 0	- 7. 8				
03/ 01	- 3. 9	- 6. 5	- 3. 9	- 11. 9				
06/ 01	3. 9	4. 4	3. 9	5. 9				
09/ 01	- 11. 4	- 16. 2	- 11. 4	- 14. 7			0. 7	1. 1
ANNUAL	- 2. 7	- 16. 9	- 2. 8	- 26. 6				
12/ 01	8. 6	8. 0	8. 6	10. 7			0. 7	0. 6
03/ 02	5. 5	1. 3	5. 6	0. 3			0. 4	0. 4
06/ 02	- 7. 5	- 10. 6	- 7. 6	- 13. 4			0. 6	0. 5
09/ 02	- 18. 6	- 20. 3	- 18. 7	- 17. 3			0. 5	0. 5
ANNUAL	- 13. 8	- 22. 1	- 13. 9	- 20. 5			2. 2	2. 0
12/ 02	8. 0	9. 9	8. 0	8. 4			0. 5	0. 4
03/ 03	- 5. 4	- 4. 9	- 5. 4	- 3. 1				
06/ 03	18. 2	17. 3	18. 2	15. 4				
09/ 03	2. 6	2. 1	2. 6	2. 6				
ANNUAL	24. 0	25. 1	24. 0	24. 4				
12/ 03	12. 9	14. 2	12. 9	12. 2				
03/ 04	1. 8	3. 0	1. 8	1. 7				
06/ 04	1. 9	0. 9	1. 9	1. 7				
09/ 04	- 1. 2	1. 5	- 1. 2	- 1. 9				
ANNUAL	15. 7	20. 5	15. 7	13. 9				
12/ 04	8. 7	10. 4	8. 8	9. 2				
03/ 05	- 1. 3	0. 1	- 1. 3	- 2. 1				
06/ 05	1. 3	1. 7	1. 3	1. 4			0. 0	0. 7
09/ 05	2. 6	3. 9	2. 7	3. 6			0. 3	0. 8
ANNUAL	11. 6	16. 7	11. 7	12. 3				
HISTORICAL CUMULATIVE	163. 0	159. 7	162. 9	147. 7			0. 3	1. 6
ANNUAL EQUIVALENT	10. 2	10. 0	10. 1	9. 5			0. 3	1. 6

VERMONT MUNICIPAL EMPLOYEES

PERFORMANCE HISTORY

ALLIANCE LARGE CAP GROWTH FUND

QUARTER ENDING	TOTAL FUND	ALLOC INDEX	EQUITY SEGMENT	S&P 500 INDEX	BOND SEGMENT	LEHMN AGG INDX	CASH SEGMENT	91-DAY T-BILL
12/ 95	- 0. 5	4. 6	- 0. 5	6. 0				
03/ 96	7. 4	5. 4	7. 4	5. 4				
06/ 96	3. 8	6. 4	3. 8	4. 5				
09/ 96	3. 2	3. 6	3. 2	3. 1				
ANNUAL	14. 5	21. 4	14. 5	20. 3				
12/ 96	11. 0	6. 0	11. 0	8. 3				
03/ 97	- 1. 2	0. 5	- 1. 2	2. 7				
06/ 97	20. 1	18. 9	20. 1	17. 5				
09/ 97	13. 3	7. 5	13. 3	7. 5				
ANNUAL	49. 2	36. 3	49. 2	40. 4				
12/ 97	- 1. 8	1. 5	- 1. 8	2. 9				
03/ 98	21. 6	15. 2	21. 6	13. 9				
06/ 98	8. 3	4. 5	8. 3	3. 3				
09/ 98	- 12. 5	- 9. 1	- 12. 5	- 9. 9				
ANNUAL	13. 2	11. 1	13. 2	9. 0				
12/ 98	32. 0	26. 7	32. 0	21. 3				
03/ 99	10. 8	6. 4	10. 8	5. 0				
06/ 99	3. 8	3. 8	3. 8	7. 0				
09/ 99	- 5. 2	- 3. 7	- 5. 2	- 6. 2				
ANNUAL	43. 8	34. 9	43. 8	27. 8				
12/ 99	21. 7	25. 1	21. 7	14. 9				
03/ 00	6. 6	7. 1	6. 6	2. 3				
06/ 00	- 3. 3	- 2. 7	- 3. 3	- 2. 7				
09/ 00	- 5. 8	- 5. 4	- 5. 8	- 1. 0				
ANNUAL	18. 1	23. 4	18. 1	13. 3				

VERMONT MUNICIPAL EMPLOYEES

PERFORMANCE HISTORY

ALLIANCE LARGE CAP GROWTH FUND

QUARTER ENDING	TOTAL FUND	ALLOC INDEX	EQUITY SEGMENT	S&P 500 INDEX	BOND SEGMENT	LEHMN AGG INDX	CASH SEGMENT	91-DAY T-BILL
12/ 00	- 14. 9	- 21. 3	- 14. 9	- 7. 8				
03/ 01	- 17. 4	- 20. 9	- 17. 4	- 11. 9				
06/ 01	6. 3	8. 4	6. 3	5. 9				
09/ 01	- 15. 5	- 19. 4	- 15. 5	- 14. 7			1. 0	1. 1
ANNUAL	- 36. 9	- 45. 6	- 36. 9	- 26. 6				
12/ 01	15. 2	15. 1	15. 2	10. 7			0. 7	0. 6
03/ 02	- 4. 6	- 2. 6	- 4. 6	0. 3			0. 5	0. 4
06/ 02	- 14. 9	- 17. 9	- 15. 5	- 13. 4			0. 5	0. 5
09/ 02	- 15. 0	- 13. 6	- 15. 0	- 17. 3				
ANNUAL	- 20. 5	- 20. 5	- 21. 1	- 20. 5			2. 2	2. 0
12/ 02	1. 8	4. 2	2. 5	8. 4				
03/ 03	- 1. 1	- 1. 1	- 1. 1	- 3. 1				
06/ 03	12. 7	14. 3	12. 7	15. 4				
09/ 03	3. 9	3. 9	3. 9	2. 6				
ANNUAL	18. 0	22. 4	18. 8	24. 4				
12/ 03	8. 8	10. 4	8. 8	12. 2				
03/ 04	1. 6	0. 8	1. 6	1. 7				
06/ 04	1. 8	1. 9	1. 8	1. 7				
09/ 04	- 5. 7	- 5. 2	- 5. 7	- 1. 9				
ANNUAL	6. 1	7. 5	6. 1	13. 9				
12/ 04	9. 2	9. 2	9. 2	9. 2				
03/ 05	- 6. 2	- 4. 1	- 6. 2	- 2. 1				
06/ 05	6. 4	2. 5	6. 4	1. 4				
09/ 05	8. 6	4. 0	8. 6	3. 6				
ANNUAL	18. 5	11. 6	18. 5	12. 3				
HISTORICAL CUMULATIVE	144. 5	94. 3	144. 5	147. 7				
ANNUAL EQUIVALENT	9. 4	6. 9	9. 4	9. 5				

VERMONT MUNICIPAL EMPLOYEES

PERFORMANCE HISTORY

LAZARD SMALL CAP FUND

<u>QUARTER ENDING</u>	<u>TOTAL FUND</u>	<u>ALLOC INDEX</u>	<u>EQUITY SEGMENT</u>	<u>S&P 500 INDEX</u>	<u>BOND SEGMENT</u>	<u>LEHMN AGG INDX</u>	<u>CASH SEGMENT</u>	<u>91-DAY T-BILL</u>
12/ 95								
03/ 96								
06/ 96								
09/ 96								
ANNUAL								
12/ 96								
03/ 97								
06/ 97								
09/ 97								
ANNUAL								
12/ 97								
03/ 98								
06/ 98								
09/ 98								
ANNUAL								
12/ 98								
03/ 99								
06/ 99								
09/ 99	- 9. 2	- 6. 3	- 9. 2	- 6. 2				
ANNUAL								
12/ 99	1. 0	18. 4	1. 0	14. 9				
03/ 00	3. 9	7. 1	3. 9	2. 3				
06/ 00	0. 2	- 3. 8	0. 2	- 2. 7				
09/ 00	5. 0	1. 1	5. 0	- 1. 0				
ANNUAL	10. 4	23. 4	10. 4	13. 3				

VERMONT MUNICIPAL EMPLOYEES

PERFORMANCE HISTORY

LAZARD SMALL CAP FUND

QUARTER ENDING	TOTAL FUND	ALLOC INDEX	EQUITY SEGMENT	S&P 500 INDEX	BOND SEGMENT	LEHMN AGG INDX	CASH SEGMENT	91-DAY T-BILL
12/ 00	6. 0	- 6. 9	6. 0	- 7. 8				
03/ 01	- 2. 9	- 6. 5	- 2. 9	- 11. 9				
06/ 01	13. 1	14. 3	13. 1	5. 9				
09/ 01	- 10. 1	- 20. 8	- 10. 3	- 14. 7				
ANNUAL	4. 6	- 21. 2	4. 4	- 26. 6				
12/ 01	20. 6	21. 1	20. 6	10. 7				
03/ 02	- 7. 2	4. 0	- 7. 2	0. 3				
06/ 02	- 9. 1	- 8. 4	- 9. 1	- 13. 4				
09/ 02	- 19. 3	- 21. 4	- 19. 3	- 17. 3				
ANNUAL	- 5. 2	- 9. 3	- 5. 2	- 20. 5				
12/ 02	5. 1	6. 2	5. 1	8. 4				
03/ 03	- 4. 9	- 4. 5	- 4. 9	- 3. 1				
06/ 03	18. 4	23. 4	18. 4	15. 4				
09/ 03	8. 3	9. 1	8. 3	2. 6				
ANNUAL	28. 2	36. 5	28. 2	24. 4				
12/ 03	14. 7	14. 5	14. 7	12. 2				
03/ 04	4. 9	6. 3	4. 9	1. 7				
06/ 04	1. 7	0. 5	1. 7	1. 7				
09/ 04	- 2. 7	- 2. 9	- 2. 7	- 1. 9				
ANNUAL	19. 1	18. 8	19. 1	13. 9				
12/ 04	11. 9	14. 1	11. 9	9. 2				
03/ 05	- 1. 8	- 5. 3	- 1. 8	- 2. 1				
06/ 05	2. 0	4. 3	2. 0	1. 4				
09/ 05	4. 9	4. 7	4. 9	3. 6				
ANNUAL	17. 5	18. 0	17. 5	12. 3				
HISTORICAL CUMULATIVE	78. 4	58. 0	78. 1	- 1. 4				
ANNUAL EQUIVALENT	9. 7	7. 6	9. 7	- 0. 2				

VERMONT MUNICIPAL EMPLOYEES

PERFORMANCE HISTORY

BRINSON - UBS

QUARTER ENDING	TOTAL FUND	ALLOC INDEX	EQUITY SEGMENT	S&P 500 INDEX	BOND SEGMENT	LEHMN AGG INDX	CASH SEGMENT	91-DAY T-BILL
12/ 95	5. 8	4. 0						
03/ 96	1. 4	2. 9						
06/ 96	2. 6	1. 6						
09/ 96	2. 7	- 0. 1						
ANNUAL	13. 1	8. 6						
12/ 96	4. 4	1. 6						
03/ 97	- 1. 4	- 1. 6						
06/ 97	7. 1	13. 0						
09/ 97	2. 4	- 0. 7						
ANNUAL	12. 8	12. 2						
12/ 97	- 1. 5	- 7. 8						
03/ 98	5. 4	14. 7						
06/ 98	0. 9	1. 1						
09/ 98	- 0. 2	- 14. 2						
ANNUAL	4. 5	- 8. 3						
12/ 98	18. 0	20. 7						
03/ 99	- 0. 1	1. 4						
06/ 99	3. 6	2. 5						
09/ 99	2. 6	4. 4						
ANNUAL	25. 3	31. 0						
12/ 99	14. 8	17. 0						
03/ 00	- 3. 4	- 0. 1						
06/ 00	0. 7	- 4. 0						
09/ 00	- 7. 3	- 8. 1						
ANNUAL	3. 4	3. 2						

VERMONT MUNICIPAL EMPLOYEES

PERFORMANCE HISTORY

BRINSON - UBS

<u>QUARTER ENDING</u>	<u>INT'L C/S</u>	<u>INT'L BOND</u>	<u>CONV</u>	<u>MORT</u>	<u>REAL ESTATE</u>	<u>SV ASSETS</u>	<u>PRVT INVEST</u>	<u>MISC</u>
12/ 95	5. 8							
03/ 96	1. 4							
06/ 96	2. 6							
09/ 96	2. 7							
ANNUAL	13. 1							
12/ 96	4. 4							
03/ 97	- 1. 4							
06/ 97	7. 1							
09/ 97	2. 4							
ANNUAL	12. 8							
12/ 97	- 1. 5							
03/ 98	5. 4							
06/ 98	0. 9							
09/ 98	- 0. 2							
ANNUAL	4. 5							
12/ 98	18. 0							
03/ 99	- 0. 1							
06/ 99	3. 6							
09/ 99	2. 6							
ANNUAL	25. 3							
12/ 99	14. 8							
03/ 00	- 3. 4							
06/ 00	0. 7							
09/ 00	- 7. 3							
ANNUAL	3. 4							

VERMONT MUNICIPAL EMPLOYEES

PERFORMANCE HISTORY

BRINSON - UBS

QUARTER ENDING	TOTAL FUND	ALLOC INDEX	EQUITY SEGMENT	S&P 500 INDEX	BOND SEGMENT	LEHMN AGG INDX	CASH SEGMENT	91-DAY T-BILL
12/ 00	- 1. 9	- 2. 7						
03/ 01	- 11. 7	- 13. 6						
06/ 01	- 2. 1	- 1. 0						
09/ 01	- 11. 0	- 14. 0						
ANNUAL	- 18. 2	- 28. 5						
12/ 01	7. 7	7. 0					0. 7	0. 6
03/ 02	3. 3	0. 5					0. 4	0. 4
06/ 02	- 0. 3	- 2. 1					0. 6	0. 5
09/ 02	- 20. 3	- 19. 7					0. 5	0. 5
ANNUAL	- 11. 5	- 15. 5					2. 1	2. 0
12/ 02	8. 9	6. 5					0. 4	0. 4
03/ 03	- 8. 1	- 8. 2					0. 4	0. 3
06/ 03	18. 2	19. 3					0. 5	0. 3
09/ 03	6. 9	8. 1					0. 3	0. 2
ANNUAL	26. 5	26. 0					1. 6	1. 3
12/ 03	16. 3	17. 1					0. 3	0. 3
03/ 04	- 2. 8	4. 3					0. 3	0. 2
06/ 04	- 0. 2	0. 2					0. 3	0. 2
09/ 04	1. 6	- 0. 3					0. 3	0. 4
ANNUAL	21. 3	22. 1					1. 2	1. 1
12/ 04	14. 3	15. 3					0. 4	0. 5
03/ 05	- 0. 4	- 0. 2					0. 4	0. 6
06/ 05	- 1. 0	- 1. 0					0. 7	0. 7
09/ 05	9. 0	10. 4					0. 6	0. 8
ANNUAL	22. 9	25. 8					2. 2	2. 6
HISTORICAL CUMULATIVE	135. 8	76. 5					7. 3	7. 2
ANNUAL EQUIVALENT	9. 0	5. 8					1. 8	1. 8

VERMONT MUNICIPAL EMPLOYEES

PERFORMANCE HISTORY

BRINSON - UBS

<u>QUARTER ENDING</u>	<u>INT'L C/S</u>	<u>INT'L BOND</u>	<u>CONV</u>	<u>MORT</u>	<u>REAL ESTATE</u>	<u>SV ASSETS</u>	<u>PRVT INVEST</u>	<u>MISC</u>
12/00	1.9							
03/01	-11.7							
06/01	2.1							
09/01	-11.0							
ANNUAL	-18.2							
12/01	7.7							
03/02	3.3							
06/02	-0.3							
09/02	-20.3							
ANNUAL	-11.6							
12/02	8.9							
03/03	-8.1							
06/03	18.2							
09/03	6.9							
ANNUAL	26.5							
12/03	16.3							
03/04	2.8							
06/04	-0.2							
09/04	1.6							
ANNUAL	21.3							
12/04	14.3							
03/05	-0.4							
06/05	-1.0							
09/05	9.0							
ANNUAL	22.9							
HISTORICAL CUMULATIVE	135.7							
ANNUAL EQUIVALENT	9.0							

VERMONT MUNICIPAL EMPLOYEES

PERFORMANCE HISTORY

MET LIFE / SSR TOWER FUND

QUARTER ENDING	TOTAL FUND	ALLOC INDEX	EQUITY SEGMENT	S&P 500 INDEX	BOND SEGMENT	LEHMN AGG INDX	CASH SEGMENT	91-DAY T-BILL
12/ 95	5. 9	1. 8						
03/ 96	- 3. 7	2. 6						
06/ 96	1. 1	2. 6						
09/ 96	2. 2	3. 0						
ANNUAL	5. 3	10. 4						
12/ 96	2. 2	2. 5						
03/ 97	2. 0	2. 5						
06/ 97	2. 2	3. 1						
09/ 97	3. 1	3. 7						
ANNUAL	9. 8	12. 4						
12/ 97	3. 0	4. 7						
03/ 98	3. 6	4. 1						
06/ 98	3. 1	4. 6						
09/ 98	3. 4	3. 9						
ANNUAL	13. 7	18. 4						
12/ 98	3. 2	3. 7						
03/ 99	2. 3	2. 7						
06/ 99	3. 2	2. 8						
09/ 99	2. 5	3. 1						
ANNUAL	11. 7	12. 8						
12/ 99	2. 9	2. 8						
03/ 00	2. 8	2. 6						
06/ 00	2. 3	3. 4						
09/ 00	2. 8	3. 2						
ANNUAL	11. 3	12. 6						

VERMONT MUNICIPAL EMPLOYEES

PERFORMANCE HISTORY

MET LIFE / SSR TOWER FUND

<u>QUARTER ENDING</u>	<u>INT'L C/S</u>	<u>INT'L BOND</u>	<u>CONV</u>	<u>MORT</u>	<u>REAL ESTATE</u>	<u>SV ASSETS</u>	<u>PRVT INVEST</u>	<u>MISC</u>
12/95					5.9			
03/96					-3.7			
06/96					1.1			
09/96					2.2			
ANNUAL					5.3			
12/96					2.2			
03/97					2.0			
06/97					2.2			
09/97					3.1			
ANNUAL					9.8			
12/97					3.0			
03/98					3.6			
06/98					3.1			
09/98					3.4			
ANNUAL					13.7			
12/98					3.2			
03/99					2.3			
06/99					3.2			
09/99					2.5			
ANNUAL					11.7			
12/99					2.9			
03/00					2.8			
06/00					2.3			
09/00					2.8			
ANNUAL					11.3			

VERMONT MUNICIPAL EMPLOYEES

PERFORMANCE HISTORY

MET LIFE / SSR TOWER FUND

QUARTER ENDING	TOTAL FUND	ALLOC INDEX	EQUITY SEGMENT	S&P 500 INDEX	BOND SEGMENT	LEHMN AGG INDX	CASH SEGMENT	91-DAY T-BILL
12/ 00	4. 4	3. 1						
03/ 01	1. 8	2. 3						
06/ 01	1. 8	2. 3						
09/ 01	0. 6	2. 4						
ANNUAL	8. 8	10. 4						
12/ 01	0. 6	1. 4						
03/ 02	0. 0	0. 7						
06/ 02	0. 9	1. 1						
09/ 02	0. 4	1. 0						
ANNUAL	2. 0	4. 3						
12/ 02	0. 6	1. 3						
03/ 03	1. 8	1. 3						
06/ 03	2. 1	1. 9						
09/ 03	2. 4	2. 1						
ANNUAL	7. 1	6. 7						
12/ 03	0. 6	4. 0						
03/ 04	1. 0	2. 8						
06/ 04	2. 9	2. 6						
09/ 04	0. 2	3. 4						
ANNUAL	4. 7	13. 3						
12/ 04	2. 4	3. 4						
03/ 05	4. 4	3. 5						
06/ 05	4. 2	5. 3						
09/ 05	5. 3	4. 4						
ANNUAL	17. 4	17. 8						
HISTORICAL CUMULATIVE	138. 6	206. 2						
ANNUAL EQUIVALENT	9. 1	11. 8						

VERMONT MUNICIPAL EMPLOYEES

PERFORMANCE HISTORY

MET LIFE / SSR TOWER FUND

<u>QUARTER ENDING</u>	<u>INT'L C/S</u>	<u>INT'L BOND</u>	<u>CONV</u>	<u>MORT</u>	<u>REAL ESTATE</u>	<u>SV ASSETS</u>	<u>PRVT INVEST</u>	<u>MISC</u>
12/ 00					4. 4			
03/ 01					1. 8			
06/ 01					1. 8			
09/ 01					0. 6			
ANNUAL					8. 8			
12/ 01					0. 6			
03/ 02					0. 0			
06/ 02					0. 9			
09/ 02					0. 4			
ANNUAL					2. 0			
12/ 02					0. 6			
03/ 03					1. 8			
06/ 03					2. 1			
09/ 03					2. 4			
ANNUAL					7. 1			
12/ 03					0. 6			
03/ 04					1. 0			
06/ 04					2. 9			
09/ 04					0. 2			
ANNUAL					4. 7			
12/ 04					2. 4			
03/ 05					4. 4			
06/ 05					4. 2			
09/ 05					5. 3			
ANNUAL					17. 4			
HISTORICAL CUMULATIVE					138. 6			
ANNUAL EQUIVALENT					9. 1			

VERMONT MUNICIPAL EMPLOYEES

PERFORMANCE HISTORY

SEIX CORE

QUARTER ENDING	TOTAL FUND	ALLOC INDEX	EQUITY SEGMENT	S&P 500 INDEX	BOND SEGMENT	LEHMN AGG INDX	CASH SEGMENT	91-DAY T-BILL
12/95								
03/96								
06/96								
09/96								
ANNUAL								
12/96								
03/97								
06/97								
09/97								
ANNUAL								
12/97								
03/98								
06/98								
09/98								
ANNUAL								
12/98								
03/99								
06/99								
09/99								
ANNUAL								
12/99								
03/00								
06/00	1.8	1.7			1.8	1.7		
09/00	3.3	3.0			3.3	3.0		
ANNUAL								

VERMONT MUNICIPAL EMPLOYEES

PERFORMANCE HISTORY

SEIX CORE

QUARTER ENDING	TOTAL FUND	ALLOC INDEX	EQUITY SEGMENT	S&P 500 INDEX	BOND SEGMENT	LEHMN AGG INDX	CASH SEGMENT	91-DAY T-BILL
12/ 00	4.5	4.2			4.5	4.2		
03/ 01	3.0	3.0			3.0	3.0		
06/ 01	0.6	0.5			0.6	0.6	1.2	1.1
09/ 01	4.6	4.6			4.6	4.6		
ANNUAL	13.3	12.9			13.3	13.0		
12/ 01	- 1.2	0.0			- 1.2	0.0		
03/ 02	0.1	0.1			0.1	0.1	0.4	0.4
06/ 02	3.0	3.7			3.1	3.7		
09/ 02	2.7	4.6			2.7	4.6		
ANNUAL	4.5	8.6			4.7	8.6		
12/ 02	2.2	1.6			2.2	1.6		
03/ 03	1.7	1.4			1.7	1.4		
06/ 03	2.9	2.5			2.9	2.5		
09/ 03	0.0	- 0.1			0.0	- 0.1		
ANNUAL	6.9	5.4			6.9	5.4		
12/ 03	0.5	0.3			0.5	0.3		
03/ 04	- 2.6	- 2.7			- 2.6	- 2.7		
06/ 04	- 2.0	- 2.4			- 2.0	- 2.4		
09/ 04	3.5	3.2			3.5	3.2		
ANNUAL	4.6	3.7			4.6	3.7		
12/ 04	0.9	1.0			0.9	1.0		
03/ 05	- 0.3	- 0.5			- 0.3	- 0.5		
06/ 05	2.7	3.0			2.7	3.0		
09/ 05	- 0.7	- 0.7			- 0.7	- 0.7		
ANNUAL	2.6	2.8			2.6	2.8		
HISTORICAL CUMULATIVE	43.0	44.4			43.2	44.4		
ANNUAL EQUIVALENT	6.7	6.9			6.7	6.9		

VERMONT MUNICIPAL EMPLOYEES

PERFORMANCE HISTORY

SEIX HIGH YIELD

QUARTER ENDING	TOTAL FUND	ALLOC INDEX	EQUITY SEGMENT	S&P 500 INDEX	BOND SEGMENT	LEHMN AGG INDX	CASH SEGMENT	91-DAY T-BILL
12/ 00								
03/ 01								
06/ 01								
09/ 01								
ANNUAL								
12/ 01								
03/ 02								
06/ 02								
09/ 02								
ANNUAL								
12/ 02								
03/ 03								
06/ 03								
09/ 03	1. 1	1. 9			1. 1	- 0. 1		
ANNUAL								
12/ 03	4. 5	6. 0			4. 5	0. 3		
03/ 04	2. 3	2. 0			2. 3	- 2. 7		
06/ 04	- 1. 5	- 0. 9			- 1. 5	- 2. 4		
09/ 04	5. 0	4. 8			5. 0	3. 2		
ANNUAL	10. 6	12. 3			10. 6	3. 7		
12/ 04	3. 0	3. 8			3. 0	1. 0		
03/ 05	- 1. 5	- 1. 2			- 1. 5	- 0. 5		
06/ 05	2. 8	2. 6			2. 8	3. 0		
09/ 05	0. 8	0. 8			0. 8	- 0. 7		
ANNUAL	5. 1	5. 9			5. 1	2. 8		
HISTORICAL CUMULATIVE	17. 4	21. 2			17. 4	6. 4		
ANNUAL EQUIVALENT	7. 4	8. 9			7. 4	2. 8		

VERMONT MUNICIPAL EMPLOYEES

PERFORMANCE HISTORY

ALTERNATIVE INVESTMENTS

QUARTER ENDING	TOTAL FUND	ALLOC INDEX	EQUITY SEGMENT	S&P 500 INDEX	BOND SEGMENT	LEHMN AGG INDX	CASH SEGMENT	91-DAY T-BILL
12/ 95	0. 0	0. 8						
03/ 96	7. 6	4. 7						
06/ 96	3. 1	7. 6						
09/ 96	- 1. 3	3. 5						
ANNUAL	9. 5	17. 6						
12/ 96	0. 0	5. 2						
03/ 97	1. 3	- 5. 4						
06/ 97	- 2. 0	18. 0						
09/ 97	1. 6	16. 9						
ANNUAL	1. 0	37. 4						
12/ 97	- 1. 0	- 6. 8						
03/ 98	0. 0	16. 9						
06/ 98	0. 0	3. 2						
09/ 98	0. 0	- 10. 6						
ANNUAL	- 0. 9	0. 5						
12/ 98	0. 0	29. 5						
03/ 99	0. 0	12. 3						
06/ 99	11. 2	9. 1						
09/ 99	0. 0	2. 2						
ANNUAL	11. 2	62. 2						
12/ 99	0. 0	48. 2						
03/ 00	0. 0	12. 4						
06/ 00	53. 7	- 13. 3						
09/ 00	0. 0	- 7. 4						
ANNUAL	53. 8	33. 7						

VERMONT MUNICIPAL EMPLOYEES

PERFORMANCE HISTORY

ALTERNATIVE INVESTMENTS

<u>QUARTER ENDING</u>	<u>INT'L C/S</u>	<u>INT'L BOND</u>	<u>CONV</u>	<u>MORT</u>	<u>REAL ESTATE</u>	<u>SV ASSETS</u>	<u>PRVT INVEST</u>	<u>MISC</u>
12/ 95							0. 0	
03/ 96							7. 6	
06/ 96							3. 1	
09/ 96							- 1. 3	
ANNUAL							9. 5	
12/ 96							0. 0	
03/ 97							1. 3	
06/ 97							- 2. 0	
09/ 97							1. 6	
ANNUAL							1. 0	
12/ 97							- 1. 0	
03/ 98							0. 0	
06/ 98							0. 0	
09/ 98							0. 0	
ANNUAL							- 0. 9	
12/ 98							0. 0	
03/ 99							0. 0	
06/ 99							11. 2	
09/ 99							0. 0	
ANNUAL							11. 2	
12/ 99							0. 0	
03/ 00							0. 0	
06/ 00							53. 7	
09/ 00							0. 0	
ANNUAL							53. 8	

VERMONT MUNICIPAL EMPLOYEES

PERFORMANCE HISTORY

ALTERNATIVE INVESTMENTS

QUARTER ENDING	TOTAL FUND	ALLOC INDEX	EQUITY SEGMENT	S&P 500 INDEX	BOND SEGMENT	LEHMN AGG INDX	CASH SEGMENT	91-DAY T-BILL
12/ 00	0. 0	- 32. 7						
03/ 01	1. 9	- 25. 1						
06/ 01	5. 7	17. 1					1. 1	1. 1
09/ 01	0. 1	- 28. 8					1. 0	1. 1
ANNUAL	7. 8	- 58. 0						
12/ 01	0. 0	28. 0					0. 7	0. 6
03/ 02	0. 0	- 5. 0					0. 5	0. 4
06/ 02	- 20. 7	- 19. 2					0. 5	0. 5
09/ 02	0. 0	- 18. 3					0. 3	0. 5
ANNUAL	- 20. 6	- 19. 6					2. 0	2. 0
12/ 02	0. 0	12. 9					0. 5	0. 4
03/ 03	0. 0	0. 4					0. 3	0. 3
06/ 03	- 6. 6	19. 1					0. 2	0. 3
09/ 03	0. 0	9. 2					0. 3	0. 2
ANNUAL	- 6. 5	47. 3					1. 4	1. 3
12/ 03	0. 0	11. 0					0. 2	0. 3
03/ 04	0. 0	- 0. 4					0. 4	0. 2
06/ 04	0. 0	2. 5					0. 2	0. 2
09/ 04	0. 0	- 6. 6					0. 3	0. 4
ANNUAL	0. 1	5. 8					1. 1	1. 1
12/ 04	- 18. 7	13. 0					0. 3	0. 5
03/ 05	0. 1	- 6. 3					0. 5	0. 6
06/ 05	- 14. 6	2. 2					0. 7	0. 7
09/ 05	0. 2	3. 7					0. 9	0. 8
ANNUAL	- 30. 4	12. 3					2. 4	2. 6
HISTORICAL CUMULATIVE	4. 5	108. 2					9. 3	9. 6
ANNUAL EQUIVALENT	0. 4	7. 6					2. 0	2. 1

VERMONT MUNICIPAL EMPLOYEES

PERFORMANCE HISTORY

ALTERNATIVE INVESTMENTS

<u>QUARTER ENDING</u>	<u>INT'L C/S</u>	<u>INT'L BOND</u>	<u>CONV</u>	<u>MORT</u>	<u>REAL ESTATE</u>	<u>SV ASSETS</u>	<u>PRVT INVEST</u>	<u>MISC</u>
12/ 00							0. 0	
03/ 01							1. 9	
06/ 01							5. 9	
09/ 01							0. 0	
ANNUAL							7. 9	
12/ 01							0. 0	
03/ 02							0. 0	
06/ 02							- 22. 2	
09/ 02							0. 0	
ANNUAL							- 22. 2	
12/ 02							0. 0	
03/ 03							0. 0	
06/ 03							- 7. 2	
09/ 03							0. 0	
ANNUAL							- 7. 2	
12/ 03							0. 0	
03/ 04							0. 0	
06/ 04							0. 0	
09/ 04							0. 0	
ANNUAL							0. 0	
12/ 04							- 22. 7	
03/ 05							0. 0	
06/ 05							- 18. 8	
09/ 05							0. 0	
ANNUAL							- 37. 3	
HISTORICAL CUMULATIVE							- 8. 4	
ANNUAL EQUIVALENT							- 0. 9	

VERMONT MUNICIPAL EMPLOYEES

PERFORMANCE HISTORY

VERMONT INVESTMENTS

QUARTER ENDING	TOTAL FUND	ALLOC INDEX	EQUITY SEGMENT	S&P 500 INDEX	BOND SEGMENT	LEHMN AGG INDX	CASH SEGMENT	91-DAY T-BILL
12/ 95	2. 0	1. 5						
03/ 96	0. 0	1. 2						
06/ 96	0. 9	1. 3						
09/ 96	1. 2	1. 4						
ANNUAL	4. 1	5. 5						
12/ 96	1. 6	1. 3						
03/ 97	0. 6	1. 3						
06/ 97	1. 0	1. 4						
09/ 97	2. 0	1. 3						
ANNUAL	5. 4	5. 4						
12/ 97	0. 5	1. 3						
03/ 98	2. 0	1. 3						
06/ 98	1. 0	1. 3						
09/ 98	1. 9	1. 4						
ANNUAL	5. 5	5. 4						
12/ 98	1. 7	1. 1						
03/ 99	1. 0	1. 1						
06/ 99	-0. 4	1. 2						
09/ 99	1. 2	1. 3						
ANNUAL	3. 6	4. 7						
12/ 99	1. 1	1. 2						
03/ 00	1. 3	1. 4						
06/ 00	1. 4	1. 5						
09/ 00	1. 9	1. 5						
ANNUAL	5. 8	5. 8						

VERMONT MUNICIPAL EMPLOYEES

PERFORMANCE HISTORY

VERMONT INVESTMENTS

QUARTER ENDING	TOTAL FUND	ALLOC INDEX	EQUITY SEGMENT	S&P 500 INDEX	BOND SEGMENT	LEHMN AGG INDX	CASH SEGMENT	91-DAY T-BILL
12/ 00	2. 1	1. 6						
03/ 01	2. 6	2. 0						
06/ 01	1. 1	0. 3			1. 5	0. 6	1. 1	1. 1
09/ 01	1. 3	1. 7			4. 6	4. 6	0. 7	1. 1
ANNUAL	7. 4	5. 8						
12/ 01	0. 4	0. 5			- 0. 4	0. 0	0. 5	0. 6
03/ 02	0. 6	0. 4			2. 0	0. 1	0. 3	0. 4
06/ 02	0. 9	0. 9			4. 0	3. 7	0. 5	0. 5
09/ 02	1. 8	1. 3			6. 9	4. 6	0. 5	0. 5
ANNUAL	3. 6	3. 2			13. 0	8. 6	1. 8	2. 0
12/ 02	0. 1	0. 5			- 0. 4	1. 6	0. 3	0. 4
03/ 03	- 0. 8	0. 6			- 6. 4	1. 4	0. 3	0. 3
06/ 03	0. 6	0. 3			1. 1	2. 5	0. 2	0. 3
09/ 03	1. 3	- 0. 1			2. 1	- 0. 1	0. 2	0. 2
ANNUAL	1. 1	1. 3			- 3. 8	5. 4	1. 0	1. 3
12/ 03	0. 5	0. 0			3. 0	0. 3	0. 2	0. 3
03/ 04	0. 4	0. 4			1. 5	2. 7	0. 3	0. 2
06/ 04	- 0. 3	0. 1			- 1. 7	- 2. 4	0. 1	0. 2
09/ 04	0. 8	0. 9			2. 2	3. 2	0. 3	0. 4
ANNUAL	1. 3	1. 5			5. 1	3. 7	0. 9	1. 1
12/ 04	1. 1	0. 6			1. 3	1. 0	1. 0	0. 5
03/ 05	1. 8	0. 6			1. 1	- 0. 5	2. 0	0. 6
06/ 05	0. 5	1. 2			- 1. 6	3. 0	0. 8	0. 7
09/ 05	1. 0	0. 0			0. 5	- 0. 7	1. 1	0. 8
ANNUAL	4. 4	2. 3			1. 3	2. 8	4. 8	2. 6
HISTORICAL CUMULATIVE	51. 1	49. 0			22. 8	28. 4	10. 7	9. 6
ANNUAL EQUIVALENT	4. 2	4. 1			4. 7	5. 7	2. 3	2. 1

VERMONT MUNICIPAL EMPLOYEES

ASSET ALLOCATION HISTORY

MUNICIPAL SYSTEM COMPOSITE

QUARTER ENDING	TOTAL VALUE	COMMON STOCK	INT'L C/S	BOND	INT'L BOND	CONV	CASH EQUIV	MORT	REAL ESTATE	SV ASSETS	PRVT INVEST	MISC
12/95	\$80,900,000											100.0
03/96	\$83,800,000											100.0
06/96	\$86,000,000	0.0		0.0					0.0		0.0	100.0
09/96	\$0											
ANNUAL AVERAGE	\$62,675,000	0.0	0.0	0.0	0.0	0.0	0.0	0.0	0.0	0.0	0.0	75.0
12/96	\$96,900,000	49.9	5.2	27.6	9.5		2.8		4.1		0.0	1.0
03/97	\$100,800,000	47.7	4.8	27.2	8.7		6.7		4.0		0.0	1.0
06/97	\$100,000,000	52.0	5.0	26.0	8.0		2.0		6.0		0.0	1.0
09/97	\$100,000,000	33.0	5.0	25.0	8.0		2.0		6.0		0.0	1.0
ANNUAL AVERAGE	\$99,425,000	50.6	5.0	26.4	8.6	0.0	3.4	0.0	5.0	0.0	0.0	1.0
12/97	\$100,000,000	48.0	6.0	28.0	7.0		4.0		7.0		0.0	
03/98	\$120,341,000	57.0	4.1	5.2	7.0		20.8		5.4		0.5	
06/98	\$134,807,000	52.4	4.0	26.8	6.8		4.5		5.2		0.3	
09/98	\$126,294,000	44.5	14.9	28.9			5.4		5.7		0.6	
ANNUAL AVERAGE	\$122,610,500	50.5	7.3	22.2	5.2	0.0	8.7	0.0	5.8	0.0	0.4	0.0
12/98	\$146,172,000	47.0	15.2	28.7			1.8		6.9		0.4	
03/99	\$151,042,000	48.2	14.7	27.4			2.4		6.9		0.4	
06/99	\$157,985,000	45.3	14.6	29.2			3.7		6.3		0.9	
09/99	\$152,699,000	43.3	15.5	30.4			3.6		6.8		0.4	
ANNUAL AVERAGE	\$151,974,500	46.0	15.0	28.9	0.0	0.0	2.9	0.0	6.7	0.0	0.5	0.0
12/99	\$167,650,000	43.5	16.2	27.5			6.0		6.3		0.5	
03/00	\$169,188,000	43.6	15.3	34.2					6.5		0.4	
06/00	\$171,940,000	41.6	15.0	36.5					6.4		0.5	
09/00	\$168,240,000	44.6	14.5	30.7			2.6		6.9		0.7	
ANNUAL AVERAGE	\$169,254,500	43.3	15.2	32.2	0.0	0.0	2.1	0.0	6.5	0.0	0.5	0.0

VERMONT MUNICIPAL EMPLOYEES

ASSET ALLOCATION HISTORY

MUNICIPAL SYSTEM COMPOSITE

QUARTER ENDING	TOTAL VALUE	COMMON STOCK	INT'L C/S	BOND	INT'L BOND	CONV	CASH EQUIV	MORT	REAL ESTATE	SV ASSETS	PRVT INVEST	MISC
12/00	\$ 170,641,000	42.7	14.6	30.1			4.9		7.1		0.6	
03/01	\$ 163,148,377	40.4	19.0	32.4			0.0		7.6		0.6	
06/01	\$ 173,114,864	40.8	18.4	31.0			1.9		7.3		0.6	
09/01	\$ 162,816,634	37.6	17.3	34.3			2.4		7.8		0.6	
ANNUAL AVERAGE	\$ 167,180,224	40.4	17.3	31.9	0.0	0.0	2.3	0.0	7.5	0.0	0.6	0.0
12/01	\$ 173,055,437	40.3	17.5	31.9			2.4		7.4		0.6	
03/02	\$ 176,976,642	39.3	17.2	35.9					7.0		0.6	
06/02	\$ 177,715,255	36.9	19.3	33.1			2.8		7.4		0.5	
09/02	\$ 156,188,036	34.9	18.8	32.2			5.4		8.2		0.5	
ANNUAL AVERAGE	\$ 169,483,843	37.8	18.2	33.3	0.0	0.0	2.6	0.0	7.5	0.0	0.5	0.0
12/02	\$ 165,064,127	39.1	19.4	31.2			2.1		7.8		0.5	
03/03	\$ 167,152,409	43.1	14.0	32.9			1.7		7.8		0.5	
06/03	\$ 185,321,463	46.3	15.3	30.8			0.1		7.2		0.4	
09/03	\$ 192,137,407	46.6	15.7	29.8			0.4		7.1		0.4	
ANNUAL AVERAGE	\$ 177,418,852	43.8	16.1	31.2	0.0	0.0	1.1	0.0	7.5	0.0	0.4	0.0
12/03	\$ 210,211,569	44.9	16.7	29.9			1.6		6.5		0.4	
03/04	\$ 218,193,787	44.3	16.6	29.6			2.9		6.3		0.3	
06/04	\$ 220,725,831	45.1	16.3	31.3			0.5		6.4		0.3	
09/04	\$ 221,739,594	43.4	16.5	33.0			0.3		6.4		0.3	
ANNUAL AVERAGE	\$ 217,717,695	44.4	16.5	31.0	0.0	0.0	1.3	0.0	6.4	0.0	0.3	0.0
12/04	\$ 239,747,213	45.0	17.5	31.1			0.2		6.0		0.2	
03/05	\$ 238,815,040	42.7	16.6	32.8			0.5		7.1		0.2	
06/05	\$ 243,738,518	43.6	16.0	32.7			0.3		7.2		0.2	
09/05	\$ 236,875,069	44.1	16.7	31.5			0.3		7.2		0.2	
ANNUAL AVERAGE	\$ 245,293,960	43.9	16.7	32.0	0.0	0.0	0.3	0.0	6.9	0.0	0.2	0.0
OVERALL AVERAGE	\$ 158,303,407	40.1	12.7	26.9	1.4	0.0	2.5	0.0	6.0	0.0	0.4	7.6

VERMONT MUNICIPAL EMPLOYEES

ASSET ALLOCATION HISTORY

DOMESTIC EQUITY COMPOSITE

QUARTER ENDING	TOTAL VALUE	COMMON STOCK	INT'L C/S	BOND	INT'L BOND	CONV	CASH EQUIV	MORT	REAL ESTATE	SV ASSETS	PRVT INVEST	MISC
12/95												
03/96												
06/96	\$0											
09/96	\$0											
ANNUAL AVERAGE	\$0	0.0	0.0	0.0	0.0	0.0	0.0	0.0	0.0	0.0	0.0	0.0
12/96												
03/97												
06/97	\$0											
09/97	\$0											
ANNUAL AVERAGE	\$0	0.0	0.0	0.0	0.0	0.0	0.0	0.0	0.0	0.0	0.0	0.0
12/97												
03/98	\$0											
06/98	\$70,256,000	100.0										
09/98	\$67,408,000	100.0										
	\$58,000,000	100.0										
ANNUAL AVERAGE	\$48,916,000	75.0	0.0	0.0	0.0	0.0	0.0	0.0	0.0	0.0	0.0	0.0
12/98												
03/99	\$68,698,000	100.0										
06/99	\$72,866,000	100.0										
09/99	\$71,308,000	100.0										
	\$65,822,000	100.0										
ANNUAL AVERAGE	\$69,673,500	100.0	0.0	0.0	0.0	0.0	0.0	0.0	0.0	0.0	0.0	0.0
12/99												
03/00	\$72,977,000	100.0										
06/00	\$74,396,000	100.0										
09/00	\$73,237,000	100.0										
	\$73,935,000	100.0										
ANNUAL AVERAGE	\$73,636,250	100.0	0.0	0.0	0.0	0.0	0.0	0.0	0.0	0.0	0.0	0.0

VERMONT MUNICIPAL EMPLOYEES

ASSET ALLOCATION HISTORY

DOMESTIC EQUITY COMPOSITE

QUARTER ENDING	TOTAL VALUE	COMMON STOCK	INT'L C/S	BOND	INT'L BOND	CONV	CASH EQUIV	MORT	REAL ESTATE	SV ASSETS	PRVT INVEST	MISC
12/00	\$72,423,000	100.0										
03/01	\$65,831,828	100.0										
06/01	\$70,240,877	100.0					0.0					
09/01	\$61,386,357	99.8					0.2					
ANNUAL AVERAGE	\$67,470,466	99.9	0.0	0.0	0.0	0.0	0.1	0.0	0.0	0.0	0.0	0.0
12/01	\$69,815,580	100.0					0.0					
03/02	\$71,452,309	99.9					0.1					
06/02	\$61,908,483	96.1					3.9					
09/02	\$61,299,498	88.9					11.1					
ANNUAL AVERAGE	\$67,118,968	96.2	0.0	0.0	0.0	0.0	3.8	0.0	0.0	0.0	0.0	0.0
12/02	\$64,513,754	100.0					0.0					
03/03	\$72,026,513	100.0										
06/03	\$85,753,952	100.0										
09/03	\$89,498,541	100.0										
ANNUAL AVERAGE	\$77,948,190	100.0	0.0	0.0	0.0	0.0	0.0	0.0	0.0	0.0	0.0	0.0
12/03	\$94,455,722	100.0										
03/04	\$96,733,008	100.0										
06/04	\$99,540,459	100.0										
09/04	\$96,296,101	100.0										
ANNUAL AVERAGE	\$96,756,323	100.0	0.0	0.0	0.0	0.0	0.0	0.0	0.0	0.0	0.0	0.0
12/04	\$107,766,695	100.0										
03/05	\$102,211,676	99.8					0.2					
06/05	\$107,581,762	99.7					0.3					
09/05	\$113,323,111	100.0					0.0					
ANNUAL AVERAGE	\$107,720,811	99.9	0.0	0.0	0.0	0.0	0.1	0.0	0.0	0.0	0.0	0.0
OVERALL AVERAGE	\$64,130,580	81.2	0.0	0.0	0.0	0.0	0.4	0.0	0.0	0.0	0.0	0.0

VERMONT MUNICIPAL EMPLOYEES

ASSET ALLOCATION HISTORY

DELAWARE

QUARTER ENDING	TOTAL VALUE	COMMON STOCK	INT'L C/S	BOND	INT'L BOND	CONV	CASH EQUIV	MORT	REAL ESTATE	SV ASSETS	PRVT INVEST	MISC
12/95	\$20,239,000	100.0										
03/96	\$21,315,000	100.0										
06/96	\$21,901,000	100.0										
09/96	\$22,773,000	100.0										
ANNUAL AVERAGE	\$21,557,000	100.0	0.0	0.0	0.0	0.0	0.0	0.0	0.0	0.0	0.0	0.0
12/96	\$24,693,000	100.0										
03/97	\$25,294,000	100.0										
06/97	\$25,267,000	100.0										
09/97	\$22,057,000	100.0										
ANNUAL AVERAGE	\$27,827,750	100.0	0.0	0.0	0.0	0.0	0.0	0.0	0.0	0.0	0.0	0.0
12/97	\$32,888,000	100.0										
03/98	\$36,896,000	100.0										
06/98	\$39,460,000	100.0										
09/98	\$27,719,000	100.0										
ANNUAL AVERAGE	\$32,240,750	100.0	0.0	0.0	0.0	0.0	0.0	0.0	0.0	0.0	0.0	0.0
12/98	\$31,794,000	100.0										
03/99	\$31,985,000	100.0										
06/99	\$27,349,000	100.0										
09/99	\$24,719,000	100.0										
ANNUAL AVERAGE	\$28,961,750	100.0	0.0	0.0	0.0	0.0	0.0	0.0	0.0	0.0	0.0	0.0
12/99	\$25,580,000	100.0										
03/00	\$24,227,000	100.0										
06/00	\$24,252,000	100.0										
09/00	\$26,354,000	100.0										
ANNUAL AVERAGE	\$25,103,250	100.0	0.0	0.0	0.0	0.0	0.0	0.0	0.0	0.0	0.0	0.0

VERMONT MUNICIPAL EMPLOYEES

ASSET ALLOCATION HISTORY

DELAWARE

QUARTER ENDING	TOTAL VALUE	COMMON STOCK	INT'L C/S	BOND	INT'L BOND	CONV	CASH EQUIV	MORT	REAL ESTATE	SV ASSETS	PRVT INVEST	MISC
12/00	\$28,984,000	100.0										
03/01	\$27,843,000	100.0										
06/01	\$25,924,644	99.9					0.1					
09/01	\$25,632,004	99.6					0.4					
ANNUAL AVERAGE	\$27,845,912	99.9	0.0	0.0	0.0	0.0	0.1	0.0	0.0	0.0	0.0	0.0
12/01	\$27,873,588	99.9					0.1					
03/02	\$26,421,666	99.9					0.1					
06/02	\$27,207,577	98.0					2.0					
09/02	\$22,136,855	99.8					0.3					
ANNUAL AVERAGE	\$26,659,922	99.4	0.0	0.0	0.0	0.0	0.6	0.0	0.0	0.0	0.0	0.0
12/02	\$23,908,736	100.0					0.0					
03/03	\$26,934,653	100.0										
06/03	\$23,472,227	100.0										
09/03	\$34,328,601	100.0										
ANNUAL AVERAGE	\$29,661,054	100.0	0.0	0.0	0.0	0.0	0.0	0.0	0.0	0.0	0.0	0.0
12/03	\$37,659,710	100.0										
03/04	\$38,328,861	100.0										
06/04	\$39,060,113	100.0										
09/04	\$38,601,324	100.0										
ANNUAL AVERAGE	\$38,412,502	100.0	0.0	0.0	0.0	0.0	0.0	0.0	0.0	0.0	0.0	0.0
12/04	\$41,975,083	100.0										
03/05	\$41,437,411	99.4					0.6					
06/05	\$41,979,641	99.2					0.8					
09/05	\$43,091,177	99.9					0.1					
ANNUAL AVERAGE	\$42,120,828	99.6	0.0	0.0	0.0	0.0	0.4	0.0	0.0	0.0	0.0	0.0
OVERALL AVERAGE	\$30,039,072	99.9	0.0	0.0	0.0	0.0	0.1	0.0	0.0	0.0	0.0	0.0

VERMONT MUNICIPAL EMPLOYEES

ASSET ALLOCATION HISTORY

ALLIANCE LARGE CAP GROWTH FUND

QUARTER ENDING	TOTAL VALUE	COMMON STOCK	INT'L C/S	BOND	INT'L BOND	CONV	CASH EQUIV	MORT	REAL ESTATE	SV ASSETS	PRVT INVEST	MISC
12/95	\$12,889,000	100.0										
03/96	\$17,473,000	100.0										
06/96	\$18,133,000	100.0										
09/96	\$18,720,000	100.0										
ANNUAL AVERAGE	\$16,803,750	100.0	0.0	0.0	0.0	0.0	0.0	0.0	0.0	0.0	0.0	0.0
12/96	\$20,779,000	100.0										
03/97	\$20,525,000	100.0										
06/97	\$21,653,000	100.0										
09/97	\$27,935,000	100.0										
ANNUAL AVERAGE	\$23,472,750	100.0	0.0	0.0	0.0	0.0	0.0	0.0	0.0	0.0	0.0	0.0
12/97	\$27,433,000	100.0										
03/98	\$29,360,000	100.0										
06/98	\$35,948,000	100.0										
09/98	\$27,952,000	100.0										
ANNUAL AVERAGE	\$31,173,250	100.0	0.0	0.0	0.0	0.0	0.0	0.0	0.0	0.0	0.0	0.0
12/98	\$36,903,000	100.0										
03/99	\$40,881,000	100.0										
06/99	\$29,988,000	100.0										
09/99	\$28,421,000	100.0										
ANNUAL AVERAGE	\$34,048,250	100.0	0.0	0.0	0.0	0.0	0.0	0.0	0.0	0.0	0.0	0.0
12/99	\$34,587,000	100.0										
03/00	\$36,857,000	100.0										
06/00	\$33,650,000	100.0										
09/00	\$33,578,000	100.0										
ANNUAL AVERAGE	\$35,168,000	100.0	0.0	0.0	0.0	0.0	0.0	0.0	0.0	0.0	0.0	0.0

VERMONT MUNICIPAL EMPLOYEES

ASSET ALLOCATION HISTORY

ALLIANCE LARGE CAP GROWTH FUND

QUARTER ENDING	TOTAL VALUE	COMMON STOCK	INT'L C/S	BOND	INT'L BOND	CONV	CASH EQUIV	MORT	REAL ESTATE	SV ASSETS	PRVT INVEST	MISC
12/00	\$28,593,000	100.0										
03/01	\$23,603,000	100.0										
06/01	\$27,081,654	100.0					0.0					
09/01	\$21,192,830	100.0					0.0					
ANNUAL AVERAGE	\$24,617,621	100.0	0.0	0.0	0.0	0.0	0.0	0.0	0.0	0.0	0.0	0.0
12/01	\$24,414,973	100.0					0.0					
03/02	\$23,284,861	100.0					0.0					
06/02	\$27,688,804	90.7					9.3					
09/02	\$23,499,088	71.2					28.8					
ANNUAL AVERAGE	\$23,221,932	90.5	0.0	0.0	0.0	0.0	9.5	0.0	0.0	0.0	0.0	0.0
12/02	\$24,168,257	100.0										
03/03	\$28,486,854	100.0										
06/03	\$32,107,299	100.0										
09/03	\$33,368,796	100.0										
ANNUAL AVERAGE	\$29,532,802	100.0	0.0	0.0	0.0	0.0	0.0	0.0	0.0	0.0	0.0	0.0
12/03	\$34,121,301	100.0										
03/04	\$34,670,760	100.0										
06/04	\$36,309,751	100.0										
09/04	\$34,225,443	100.0										
ANNUAL AVERAGE	\$34,831,814	100.0	0.0	0.0	0.0	0.0	0.0	0.0	0.0	0.0	0.0	0.0
12/04	\$39,568,923	100.0										
03/05	\$37,115,764	100.0										
06/05	\$33,504,571	100.0										
09/05	\$42,910,388	100.0										
ANNUAL AVERAGE	\$39,774,912	100.0	0.0	0.0	0.0	0.0	0.0	0.0	0.0	0.0	0.0	0.0
OVERALL AVERAGE	\$29,264,508	99.0	0.0	0.0	0.0	0.0	1.0	0.0	0.0	0.0	0.0	0.0

VERMONT MUNICIPAL EMPLOYEES

ASSET ALLOCATION HISTORY

LAZARD SMALL CAP FUND

QUARTER ENDING	TOTAL VALUE	COMMON STOCK	INT'L C/S	BOND	INT'L BOND	CONV	CASH EQUIV	MORT	REAL ESTATE	SV ASSETS	PRVT INVEST	MISC
12/95 03/96 06/96 09/96												
ANNUAL AVERAGE	\$0	0.0	0.0	0.0	0.0	0.0	0.0	0.0	0.0	0.0	0.0	0.0
12/96 03/97 06/97 09/97												
ANNUAL AVERAGE	\$0	0.0	0.0	0.0	0.0	0.0	0.0	0.0	0.0	0.0	0.0	0.0
12/97 03/98 06/98 09/98												
ANNUAL AVERAGE	\$0	0.0	0.0	0.0	0.0	0.0	0.0	0.0	0.0	0.0	0.0	0.0
12/98 03/99 06/99 09/99	\$13,970,000 \$12,682,000	100.0 100.0										
ANNUAL AVERAGE	\$13,326,000	100.0	0.0	0.0	0.0	0.0	0.0	0.0	0.0	0.0	0.0	0.0
12/99 03/00 06/00 09/00	\$12,810,000 \$13,312,000 \$13,335,000 \$14,003,000	100.0 100.0 100.0 100.0										
ANNUAL AVERAGE	\$13,365,000	100.0	0.0	0.0	0.0	0.0	0.0	0.0	0.0	0.0	0.0	0.0

VERMONT MUNICIPAL EMPLOYEES

ASSET ALLOCATION HISTORY

LAZARD SMALL CAP FUND

QUARTER ENDING	TOTAL VALUE	COMMON STOCK	INT'L C/S	BOND	INT'L BOND	CONV	CASH EQUIV	MORT	REAL ESTATE	SV ASSETS	PRVT INVEST	MISC
12/00	\$14,846,000	100.0										
03/01	\$14,385,828	100.0										
06/01	\$16,334,379	100.0										
09/01	\$14,561,523	100.0										
ANNUAL AVERAGE	\$15,006,933	100.0	0.0	0.0	0.0	0.0	0.0	0.0	0.0	0.0	0.0	0.0
12/01	\$17,527,019	100.0										
03/02	\$19,745,782	100.0										
06/02	\$19,012,102	100.0										
09/02	\$15,663,555	100.0										
ANNUAL AVERAGE	\$17,237,115	100.0	0.0	0.0	0.0	0.0	0.0	0.0	0.0	0.0	0.0	0.0
12/02	\$16,436,761	100.0										
03/03	\$16,605,006	100.0										
06/03	\$20,174,426	100.0										
09/03	\$21,801,144	100.0										
ANNUAL AVERAGE	\$18,754,334	100.0	0.0	0.0	0.0	0.0	0.0	0.0	0.0	0.0	0.0	0.0
12/03	\$22,674,711	100.0										
03/04	\$23,733,387	100.0										
06/04	\$24,170,595	100.0										
09/04	\$23,469,334	100.0										
ANNUAL AVERAGE	\$23,512,007	100.0	0.0	0.0	0.0	0.0	0.0	0.0	0.0	0.0	0.0	0.0
12/04	\$26,222,689	100.0										
03/05	\$23,658,501	100.0										
06/05	\$28,097,550	100.0										
09/05	\$27,321,546	100.0										
ANNUAL AVERAGE	\$25,825,072	100.0	0.0	0.0	0.0	0.0	0.0	0.0	0.0	0.0	0.0	0.0
OVERALL AVERAGE	\$18,517,455	100.0	0.0	0.0	0.0	0.0	0.0	0.0	0.0	0.0	0.0	0.0

VERMONT MUNICIPAL EMPLOYEES

ASSET ALLOCATION HISTORY

BRINSON - UBS

QUARTER ENDING	TOTAL VALUE	COMMON STOCK	INT'L C/S	BOND	INT'L BOND	CONV	CASH EQUIV	MORT	REAL ESTATE	SV ASSETS	PRVT INVEST	MISC
12/95	\$17,023,000		100.0									
03/96	\$19,474,000		100.0									
06/96	\$19,977,000		100.0									
09/96	\$20,513,000		100.0									
ANNUAL AVERAGE	\$19,246,750	0.0	100.0	0.0	0.0	0.0	0.0	0.0	0.0	0.0	0.0	0.0
12/96	\$21,422,000		100.0									
03/97	\$21,111,000		100.0									
06/97	\$22,605,000		100.0									
09/97	\$23,144,000		100.0									
ANNUAL AVERAGE	\$22,070,500	0.0	100.0	0.0	0.0	0.0	0.0	0.0	0.0	0.0	0.0	0.0
12/97	\$22,817,000		100.0									
03/98	\$24,028,000		100.0									
06/98	\$24,235,000		100.0									
09/98	\$24,188,000		100.0									
ANNUAL AVERAGE	\$23,817,000	0.0	100.0	0.0	0.0	0.0	0.0	0.0	0.0	0.0	0.0	0.0
12/98	\$22,289,000		100.0									
03/99	\$22,269,000		100.0									
06/99	\$23,069,000		100.0									
09/99	\$23,660,000		100.0									
ANNUAL AVERAGE	\$22,821,750	0.0	100.0	0.0	0.0	0.0	0.0	0.0	0.0	0.0	0.0	0.0
12/99	\$27,156,000		100.0									
03/00	\$26,222,000		100.0									
06/00	\$28,395,000		100.0									
09/00	\$24,448,000		100.0									
ANNUAL AVERAGE	\$26,055,250	0.0	100.0	0.0	0.0	0.0	0.0	0.0	0.0	0.0	0.0	0.0

VERMONT MUNICIPAL EMPLOYEES

ASSET ALLOCATION HISTORY

BRINSON - UBS

QUARTER ENDING	TOTAL VALUE	COMMON STOCK	INT'L C/S	BOND	INT'L BOND	CONV	CASH EQUIV	MORT	REAL ESTATE	SV ASSETS	PRVT INVEST	MISC
12/00	\$24,917,000		100.0									
03/01	\$23,994,000		100.0									
06/01	\$23,623,739		100.0									
09/01	\$26,143,429		100.0				0.0					
ANNUAL AVERAGE	\$28,919,542	0.0	100.0	0.0	0.0	0.0	0.0	0.0	0.0	0.0	0.0	0.0
12/01	\$30,301,064		100.0				0.0					
03/02	\$31,307,322		100.0				0.0					
06/02	\$33,162,921		100.0				0.0					
09/02	\$29,362,509		100.0				0.0					
ANNUAL AVERAGE	\$31,033,454	0.0	100.0	0.0	0.0	0.0	0.0	0.0	0.0	0.0	0.0	0.0
12/02	\$31,983,528		100.0				0.0					
03/03	\$23,481,991		100.0				0.0					
06/03	\$28,264,951		100.0				0.0					
09/03	\$30,220,275		100.0				0.0					
ANNUAL AVERAGE	\$28,487,686	0.0	100.0	0.0	0.0	0.0	0.0	0.0	0.0	0.0	0.0	0.0
12/03	\$35,151,536		100.0				0.0					
03/04	\$36,136,452		100.0				0.0					
06/04	\$38,072,855		100.0				0.0					
09/04	\$36,639,208		100.0				0.0					
ANNUAL AVERAGE	\$36,000,013	0.0	100.0	0.0	0.0	0.0	0.0	0.0	0.0	0.0	0.0	0.0
12/04	\$41,888,190		100.0				0.0					
03/05	\$39,723,228		100.0				0.0					
06/05	\$39,348,285		100.0				0.0					
09/05	\$42,879,541		100.0				0.0					
ANNUAL AVERAGE	\$40,959,811	0.0	100.0	0.0	0.0	0.0	0.0	0.0	0.0	0.0	0.0	0.0
OVERALL AVERAGE	\$27,941,176	0.0	100.0	0.0	0.0	0.0	0.0	0.0	0.0	0.0	0.0	0.0

VERMONT MUNICIPAL EMPLOYEES

ASSET ALLOCATION HISTORY

MET LIFE / SSR TOWER FUND

QUARTER ENDING	TOTAL VALUE	COMMON STOCK	INT'L C/S	BOND	INT'L BOND	CONV	CASH EQUIV	MORT	REAL ESTATE	SV ASSETS	PRVT INVEST	MISC
12/95	\$1,927,000								100.0			
03/96	\$1,856,000								100.0			
06/96	\$1,339,000								100.0			
09/96	\$739,000								100.0			
ANNUAL AVERAGE	\$1,315,250	0.0	0.0	0.0	0.0	0.0	0.0	0.0	100.0	0.0	0.0	0.0
12/96	\$749,000								100.0			
03/97	\$4,045,000								100.0			
06/97	\$2,572,000								100.0			
09/97	\$6,652,000								100.0			
ANNUAL AVERAGE	\$4,504,500	0.0	0.0	0.0	0.0	0.0	0.0	0.0	100.0	0.0	0.0	0.0
12/97	\$6,838,000								100.0			
03/98	\$7,020,000								100.0			
06/98	\$7,020,000								100.0			
09/98	\$7,248,000								100.0			
ANNUAL AVERAGE	\$7,031,500	0.0	0.0	0.0	0.0	0.0	0.0	0.0	100.0	0.0	0.0	0.0
12/98	\$10,085,000								100.0			
03/99	\$10,389,000								100.0			
06/99	\$10,024,000								100.0			
09/99	\$10,340,000								100.0			
ANNUAL AVERAGE	\$10,209,500	0.0	0.0	0.0	0.0	0.0	0.0	0.0	100.0	0.0	0.0	0.0
12/99	\$10,598,000								100.0			
03/00	\$11,208,000								100.0			
06/00	\$11,355,000								100.0			
09/00	\$11,672,000								100.0			
ANNUAL AVERAGE	\$11,208,250	0.0	0.0	0.0	0.0	0.0	0.0	0.0	100.0	0.0	0.0	0.0

VERMONT MUNICIPAL EMPLOYEES

ASSET ALLOCATION HISTORY

MET LIFE / SSR TOWER FUND

QUARTER ENDING	TOTAL VALUE	COMMON STOCK	INT'L C/S	BOND	INT'L BOND	CONV	CASH EQUIV	MORT	REAL ESTATE	SV ASSETS	PRVT INVEST	MISC
12/00	\$12,181,000								100.0			
03/01	\$12,403,000								100.0			
06/01	\$12,628,498								100.0			
09/01	\$12,698,462								100.0			
ANNUAL AVERAGE	\$12,477,740	0.0	0.0	0.0	0.0	0.0	0.0	0.0	100.0	0.0	0.0	0.0
12/01	\$12,739,788								100.0			
03/02	\$12,705,292								100.0			
06/02	\$12,782,891								100.0			
09/02	\$12,798,823								100.0			
ANNUAL AVERAGE	\$12,756,574	0.0	0.0	0.0	0.0	0.0	0.0	0.0	100.0	0.0	0.0	0.0
12/02	\$12,889,065								100.0			
03/03	\$13,086,370								100.0			
06/03	\$13,334,203								100.0			
09/03	\$13,620,576								100.0			
ANNUAL AVERAGE	\$13,232,554	0.0	0.0	0.0	0.0	0.0	0.0	0.0	100.0	0.0	0.0	0.0
12/03	\$13,660,495								100.0			
03/04	\$13,766,796								100.0			
06/04	\$14,125,010								100.0			
09/04	\$14,105,906								100.0			
ANNUAL AVERAGE	\$13,914,552	0.0	0.0	0.0	0.0	0.0	0.0	0.0	100.0	0.0	0.0	0.0
12/04	\$14,404,492								100.0			
03/05	\$17,002,951								100.0			
06/05	\$17,667,544								100.0			
09/05	\$16,558,732								100.0			
ANNUAL AVERAGE	\$16,908,430	0.0	0.0	0.0	0.0	0.0	0.0	0.0	100.0	0.0	0.0	0.0
OVERALL AVERAGE	\$10,355,885	0.0	0.0	0.0	0.0	0.0	0.0	0.0	100.0	0.0	0.0	0.0

VERMONT MUNICIPAL EMPLOYEES

ASSET ALLOCATION HISTORY

SEIX CORE

QUARTER ENDING	TOTAL VALUE	COMMON STOCK	INT'L C/S	BOND	INT'L BOND	CONV	CASH EQUIV	MORT	REAL ESTATE	SV ASSETS	PRVT INVEST	MISC
12/95 03/96 06/96 09/96												
ANNUAL AVERAGE	\$0	0.0	0.0	0.0	0.0	0.0	0.0	0.0	0.0	0.0	0.0	0.0
12/96 03/97 06/97 09/97												
ANNUAL AVERAGE	\$0	0.0	0.0	0.0	0.0	0.0	0.0	0.0	0.0	0.0	0.0	0.0
12/97 03/98 06/98 09/98												
ANNUAL AVERAGE	\$0	0.0	0.0	0.0	0.0	0.0	0.0	0.0	0.0	0.0	0.0	0.0
12/98 03/99 06/99 09/99												
ANNUAL AVERAGE	\$0	0.0	0.0	0.0	0.0	0.0	0.0	0.0	0.0	0.0	0.0	0.0
12/99 03/00 06/00 09/00	\$52,397,000 \$53,366,000 \$53,106,000			100.0 100.0 100.0								
ANNUAL AVERAGE	\$53,623,000	0.0	0.0	100.0	0.0	0.0	0.0	0.0	0.0	0.0	0.0	0.0

VERMONT MUNICIPAL EMPLOYEES

ASSET ALLOCATION HISTORY

SEIX CORE

QUARTER ENDING	TOTAL VALUE	COMMON STOCK	INT'L C/S	BOND	INT'L BOND	CONV	CASH EQUIV	MORT	REAL ESTATE	SV ASSETS	PRVT INVEST	MISC
12/00	\$57,610,000			100.0								
03/01	\$55,337,307			100.0								
06/01	\$55,723,091			100.0			0.0					
09/01	\$55,135,870			100.0								
ANNUAL AVERAGE	\$54,451,567	0.0	0.0	100.0	0.0	0.0	0.0	0.0	0.0	0.0	0.0	0.0
12/01	\$54,462,538			100.0								
03/02	\$54,539,509			100.0								
06/02	\$53,149,808			100.0								
09/02	\$53,646,988			100.0								
ANNUAL AVERAGE	\$53,699,711	0.0	0.0	100.0	0.0	0.0	0.0	0.0	0.0	0.0	0.0	0.0
12/02	\$50,739,841			100.0								
03/03	\$54,640,083			100.0								
06/03	\$54,733,386			100.0								
09/03	\$54,723,141			100.0								
ANNUAL AVERAGE	\$50,209,113	0.0	0.0	100.0	0.0	0.0	0.0	0.0	0.0	0.0	0.0	0.0
12/03	\$51,966,772			100.0								
03/04	\$53,341,763			100.0								
06/04	\$53,213,956			100.0								
09/04	\$51,796,577			100.0								
ANNUAL AVERAGE	\$56,329,767	0.0	0.0	100.0	0.0	0.0	0.0	0.0	0.0	0.0	0.0	0.0
12/04	\$62,842,119			100.0								
03/05	\$65,697,950			100.0								
06/05	\$67,471,617			100.0								
09/05	\$67,991,211			100.0								
ANNUAL AVERAGE	\$66,000,724	0.0	0.0	100.0	0.0	0.0	0.0	0.0	0.0	0.0	0.0	0.0
OVERALL AVERAGE	\$55,810,110	0.0	0.0	100.0	0.0	0.0	0.0	0.0	0.0	0.0	0.0	0.0

VERMONT MUNICIPAL EMPLOYEES

ASSET ALLOCATION HISTORY

SEIX HIGH YIELD

QUARTER ENDING	TOTAL VALUE	COMMON STOCK	INT'L C/S	BOND	INT'L BOND	CONV	CASH EQUIV	MORT	REAL ESTATE	SV ASSETS	PRVT INVEST	MISC
12/00												
03/01												
06/01												
09/01												
ANNUAL AVERAGE	\$0	0.0	0.0	0.0	0.0	0.0	0.0	0.0	0.0	0.0	0.0	0.0
12/01												
03/02												
06/02												
09/02												
ANNUAL AVERAGE	\$0	0.0	0.0	0.0	0.0	0.0	0.0	0.0	0.0	0.0	0.0	0.0
12/02												
03/03												
06/03	\$9,054,927			100.0								
09/03	\$9,137,381			100.0								
ANNUAL AVERAGE	\$9,096,154	0.0	0.0	100.0	0.0	0.0	0.0	0.0	0.0	0.0	0.0	0.0
12/03	\$10,578,524			100.0								
03/04	\$10,804,414			100.0								
06/04	\$10,631,852			100.0								
09/04	\$11,144,985			100.0			0.0					
ANNUAL AVERAGE	\$10,789,944	0.0	0.0	100.0	0.0	0.0	0.0	0.0	0.0	0.0	0.0	0.0
12/04	\$11,461,056			100.0								
03/05	\$12,268,684			100.0								
06/05	\$12,598,449			100.0								
09/05	\$12,680,552			100.0								
ANNUAL AVERAGE	\$12,252,185	0.0	0.0	100.0	0.0	0.0	0.0	0.0	0.0	0.0	0.0	0.0
OVERALL AVERAGE	\$11,036,082	0.0	0.0	100.0	0.0	0.0	0.0	0.0	0.0	0.0	0.0	0.0

VERMONT MUNICIPAL EMPLOYEES

ASSET ALLOCATION HISTORY

ALTERNATIVE INVESTMENTS

QUARTER ENDING	TOTAL VALUE	COMMON STOCK	INT'L C/S	BOND	INT'L BOND	CONV	CASH EQUIV	MORT	REAL ESTATE	SV ASSETS	PRVT INVEST	MISC
12/95	\$570,000										100.0	
03/96	\$613,000										100.0	
06/96	\$614,000										100.0	
09/96	\$606,000										100.0	
ANNUAL AVERAGE	\$600,750	0.0	0.0	0.0	0.0	0.0	0.0	0.0	0.0	0.0	100.0	0.0
12/96	\$606,000										100.0	
03/97	\$614,000										100.0	
06/97	\$602,000										100.0	
09/97	\$611,000										100.0	
ANNUAL AVERAGE	\$608,250	0.0	0.0	0.0	0.0	0.0	0.0	0.0	0.0	0.0	100.0	0.0
12/97	\$605,000										100.0	
03/98	\$605,000										100.0	
06/98	\$606,000										100.0	
09/98	\$606,000										100.0	
ANNUAL AVERAGE	\$605,500	0.0	0.0	0.0	0.0	0.0	0.0	0.0	0.0	0.0	100.0	0.0
12/98	\$606,000										100.0	
03/99	\$606,000										100.0	
06/99	\$674,000										100.0	
09/99	\$674,000										100.0	
ANNUAL AVERAGE	\$640,000	0.0	0.0	0.0	0.0	0.0	0.0	0.0	0.0	0.0	100.0	0.0
12/99	\$674,000										100.0	
03/00	\$674,000										100.0	
06/00	\$1,036,000										100.0	
09/00	\$1,036,000										100.0	
ANNUAL AVERAGE	\$855,000	0.0	0.0	0.0	0.0	0.0	0.0	0.0	0.0	0.0	100.0	0.0

VERMONT MUNICIPAL EMPLOYEES

ASSET ALLOCATION HISTORY

ALTERNATIVE INVESTMENTS

QUARTER ENDING	TOTAL VALUE	COMMON STOCK	INT'L C/S	BOND	INT'L BOND	CONV	CASH EQUIV	MORT	REAL ESTATE	SV ASSETS	PRVT INVEST	MISC
12/00	\$1,037,000										100.0	
03/01	\$1,056,137						1.3				98.7	
06/01	\$1,116,579						6.6				93.4	
09/01	\$1,117,282						6.7				93.3	
ANNUAL AVERAGE	\$1,081,750	0.0	0.0	0.0	0.0	0.0	3.6	0.0	0.0	0.0	96.4	0.0
12/01	\$1,117,792						6.7				93.3	
03/02	\$1,118,176						6.8				93.3	
06/02	\$886,926						8.6				91.5	
09/02	\$887,273						8.6				91.4	
ANNUAL AVERAGE	\$1,002,542	0.0	0.0	0.0	0.0	0.0	7.6	0.0	0.0	0.0	92.4	0.0
12/02	\$887,581						8.6				91.4	
03/03	\$887,819						8.6				91.4	
06/03	\$829,498						9.3				90.7	
09/03	\$829,689						9.3				90.7	
ANNUAL AVERAGE	\$858,647	0.0	0.0	0.0	0.0	0.0	9.0	0.0	0.0	0.0	91.1	0.0
12/03	\$829,881						9.3				90.7	
03/04	\$830,073						9.3				90.7	
06/04	\$830,258						9.4				90.6	
09/04	\$830,501						9.4				90.6	
ANNUAL AVERAGE	\$830,178	0.0	0.0	0.0	0.0	0.0	9.3	0.0	0.0	0.0	90.7	0.0
12/04	\$739,976						21.4				78.6	
03/05	\$740,729						21.5				78.5	
06/05	\$632,414						25.3				74.7	
09/05	\$633,779						25.5				74.5	
ANNUAL AVERAGE	\$686,725	0.0	0.0	0.0	0.0	0.0	23.4	0.0	0.0	0.0	76.6	0.0
OVERALL AVERAGE	\$776,934	0.0	0.0	0.0	0.0	0.0	5.3	0.0	0.0	0.0	94.7	0.0

VERMONT MUNICIPAL EMPLOYEES

ASSET ALLOCATION HISTORY

VERMONT INVESTMENTS

QUARTER ENDING	TOTAL VALUE	COMMON STOCK	INT'L C/S	BOND	INT'L BOND	CONV	CASH EQUIV	MORT	REAL ESTATE	SV ASSETS	PRVT INVEST	MISC
12/95	\$4,592,000						100.0					
03/96	\$4,034,000						100.0					
06/96	\$3,359,000						100.0					
09/96	\$3,435,000						100.0					
ANNUAL AVERAGE	\$3,855,000	0.0	0.0	0.0	0.0	0.0	100.0	0.0	0.0	0.0	0.0	0.0
12/96	\$6,345,000						100.0					
03/97	\$7,030,000						100.0					
06/97	\$7,826,000						100.0					
09/97	\$2,484,000						100.0					
ANNUAL AVERAGE	\$4,671,250	0.0	0.0	0.0	0.0	0.0	100.0	0.0	0.0	0.0	0.0	0.0
12/97	\$1,899,000						100.0					
03/98	\$1,671,000						100.0					
06/98	\$3,311,000						100.0					
09/98	\$2,566,000						100.0					
ANNUAL AVERAGE	\$3,111,750	0.0	0.0	0.0	0.0	0.0	100.0	0.0	0.0	0.0	0.0	0.0
12/98	\$3,136,000						100.0					
03/99	\$4,155,000						100.0					
06/99	\$3,676,000						100.0					
09/99	\$3,699,000						100.0					
ANNUAL AVERAGE	\$4,916,500	0.0	0.0	0.0	0.0	0.0	100.0	0.0	0.0	0.0	0.0	0.0
12/99	\$9,978,000						100.0					
03/00	\$4,291,000						100.0					
06/00	\$3,551,000						100.0					
09/00	\$2,044,000						100.0					
ANNUAL AVERAGE	\$5,716,000	0.0	0.0	0.0	0.0	0.0	100.0	0.0	0.0	0.0	0.0	0.0

VERMONT MUNICIPAL EMPLOYEES

ASSET ALLOCATION HISTORY

VERMONT INVESTMENTS

QUARTER ENDING	TOTAL VALUE	COMMON STOCK	INT'L C/S	BOND	INT'L BOND	CONV	CASH EQUIV	MORT	REAL ESTATE	SV ASSETS	PRVT INVEST	MISC
12/00	\$2,473,000						100.0					
03/01	\$3,526,105			100.0								
06/01	\$4,782,280			17.6			82.4					
09/01	\$4,335,234			15.2			84.8					
ANNUAL AVERAGE	\$2,779,160	0.0	0.0	33.2	0.0	0.0	66.8	0.0	0.0	0.0	0.0	0.0
12/01	\$4,618,675			14.2			85.8					
03/02	\$4,854,034			11.0			89.0					
06/02	\$4,624,726			23.8			76.2					
09/02	\$2,192,943			31.4			68.6					
ANNUAL AVERAGE	\$3,872,595	0.0	0.0	20.1	0.0	0.0	79.9	0.0	0.0	0.0	0.0	0.0
12/02	\$4,050,358			17.0			83.0					
03/03	\$3,029,633			10.8			89.2					
06/03	\$3,350,546			95.0			5.0					
09/03	\$1,107,804			30.7			69.3					
ANNUAL AVERAGE	\$2,134,585	0.0	0.0	38.4	0.0	0.0	61.6	0.0	0.0	0.0	0.0	0.0
12/03	\$3,568,639			9.2			90.8					
03/04	\$3,581,281			5.1			94.9					
06/04	\$3,311,441			25.0			75.0					
09/04	\$926,316			33.4			66.6					
ANNUAL AVERAGE	\$3,096,919	0.0	0.0	18.2	0.0	0.0	81.8	0.0	0.0	0.0	0.0	0.0
12/04	\$644,685			48.6			51.4					
03/05	\$1,169,822			27.1			72.9					
06/05	\$438,447			71.1			28.9					
09/05	\$808,143			36.1			63.9					
ANNUAL AVERAGE	\$765,274	0.0	0.0	45.7	0.0	0.0	54.3	0.0	0.0	0.0	0.0	0.0
OVERALL AVERAGE	\$3,491,903	0.0	0.0	15.6	0.0	0.0	84.4	0.0	0.0	0.0	0.0	0.0

VERMONT MUNICIPAL EMPLOYEES

POLICY INDEX DETAIL

POLICY ACCOUNT: R2W0200

MUNI POLICY INDEX

EFFECTIVE DATE: 03/ 92

40% S&P 500
5% 90 DAY T-BILLS
5% NCREIF CL PROP

35% LB AGGREGATE
5% PRIVATE EQ 12%

5% SSB WGBI EX US
5% MS EAFE NET

EFFECTIVE DATE: 03/ 96

48% S&P 500
7% CITI WGBI EX US

28% LB AGGREGATE
6% MS EAFE NET

7% NCREIF CL PROP
4% PRIVATE EQ 12%

EFFECTIVE DATE: 03/ 98

48% S&P 500
6% MS EAFE NET

30% LB AGGREGATE
5% CITI WGBI EX US

7% NCREIF CL PROP
4% PRIVATE EQ 12%

EFFECTIVE DATE: 09/ 98

43% S&P 500
7% NCREIF CL PROP

32% LB AGGREGATE
4% PRIVATE EQ 13%

14% MS EAFE NET

EFFECTIVE DATE: 03/ 01

30% LB AGGREGATE
15% R 1000(R) GR
2% PRIVATE EQ 13%

20% MS EAFE NET
10% R 2000(R)

16% R 1000(R) VALUE
7% NCREIF CL PROP

EFFECTIVE DATE: 10/ 02

32% LB AGGREGATE
14% MS EAFE NET
4% PRIVATE EQ 13%

17% R 1000(R) VALUE
10% R 2000(R)

16% R 1000(R) GR
7% NCREIF CL PROP

EFFECTIVE DATE: 05/ 03

27% LB AGGREGATE

17% R 1000(R) VALUE

16% R 1000(R) GR

VERMONT MUNICIPAL EMPLOYEES

POLICY INDEX DETAIL

16% MS EAFE NET
5% ML HIGH YIELD

10% R 2000(R)
2% PRIVATE EQ 13%

7% NCREIF PROPERTY

VERMONT MUNICIPAL EMPLOYEES

ALLOCATION INDEX DETAIL

ACCOUNT: R2W0201 DELAWARE

EFFECTIVE DATE: 06/ 00

COMMON STOCK:	S&P VALUE	CONVERTIBLES:	FB CONV BOND
CASH EQUIV.:	90 DAY T-BILLS	BONDS:	LB AGGREGATE
MORTGAGES:	CITI MORTGAGE	REAL ESTATE:	NCREIF CL PROP
INTL COMMON STK:	MS EAFE NET	INT'L BONDS:	ML WORLD BOND
STABLE VAL ASTS:	5YR GIC ROR	MISC:	DELAWARE
PRIVATE INVEST:	NASDAQ COMP	CASH:	DELAWARE

EFFECTIVE DATE: 10/ 02

COMMON STOCK:	R 1000(R) VALUE	CONVERTIBLES:	FB CONV BOND
CASH EQUIV.:	90 DAY T-BILLS	BONDS:	LB AGGREGATE
MORTGAGES:	CITI MORTGAGE	REAL ESTATE:	NCREIF CL PROP
INTL COMMON STK:	MS EAFE NET	INT'L BONDS:	ML WORLD BOND
STABLE VAL ASTS:	5YR GIC ROR	MISC:	DELAWARE
PRIVATE INVEST:	NASDAQ COMP	CASH:	DELAWARE

ACCOUNT: R2W0202 ALLIANCE LARGE CAP GROWTH FUND

EFFECTIVE DATE: 06/ 00

COMMON STOCK:	R 1000(R) GR	CONVERTIBLES:	FB CONV BOND
CASH EQUIV.:	90 DAY T-BILLS	BONDS:	LB AGGREGATE
MORTGAGES:	CITI MORTGAGE	REAL ESTATE:	NCREIF CL PROP
INTL COMMON STK:	MS EAFE NET	INT'L BONDS:	ML WORLD BOND
STABLE VAL ASTS:	5YR GIC ROR	MISC:	ALLIANCE
PRIVATE INVEST:	NASDAQ COMP	CASH:	ALLIANCE

VERMONT MUNICIPAL EMPLOYEES

ALLOCATION INDEX DETAIL

ACCOUNT: R2W0203

LAZARD SMALL CAP FUND

EFFECTIVE DATE: 06/00

COMMON STOCK:	R 2000(R)	CONVERTIBLES:	FB CONV BOND
CASH EQUIV.:	90 DAY T-BILLS	BONDS:	LB AGGREGATE
MORTGAGES:	CITI MORTGAGE	REAL ESTATE:	NCREIF CL PROP
INTL COMMON STK:	MS EAFE NET	INT'L BONDS:	ML WORLD BOND
STABLE VAL ASTS:	5YR GIC ROR	MISC:	LAZARD
PRIVATE INVEST:	NASDAQ COMP	CASH:	LAZARD

ACCOUNT: R2W0204

BRINSON - UBS

EFFECTIVE DATE: 06/00

COMMON STOCK:	S&P 500	CONVERTIBLES:	FB CONV BOND
CASH EQUIV.:	90 DAY T-BILLS	BONDS:	LB AGGREGATE
MORTGAGES:	CITI MORTGAGE	REAL ESTATE:	NCREIF CL PROP
INTL COMMON STK:	MS EAFE NET	INT'L BONDS:	ML WORLD BOND
STABLE VAL ASTS:	5YR GIC ROR	MISC:	UBS
PRIVATE INVEST:	NASDAQ COMP	CASH:	UBS

ACCOUNT: R2W0207

MET LIFE / SSR TOWER FUND

EFFECTIVE DATE: 06/00

COMMON STOCK:	S&P 500	CONVERTIBLES:	FB CONV BOND
CASH EQUIV.:	90 DAY T-BILLS	BONDS:	LB AGGREGATE
MORTGAGES:	CITI MORTGAGE	REAL ESTATE:	NCREIF PROPERTY
INTL COMMON STK:	MS EAFE NET	INT'L BONDS:	ML WORLD BOND
STABLE VAL ASTS:	5YR GIC ROR	MISC:	SSR TOWER FUND
PRIVATE INVEST:	NASDAQ COMP	CASH:	SSR TOWER FUND

VERMONT MUNICIPAL EMPLOYEES

ALLOCATION INDEX DETAIL

ACCOUNT: R2W0208 SEIX CORE

EFFECTIVE DATE: 06/ 00

COMMON STOCK:	S&P 500	CONVERTIBLES:	FB CONV BOND
CASH EQUIV.:	90 DAY T-BILLS	BONDS:	LB AGGREGATE
MORTGAGES:	CITI MORTGAGE	REAL ESTATE:	NCREIF CL PROP
INTL COMMON STK:	MS EAFE NET	INT'L BONDS:	ML WORLD BOND
STABLE VAL ASTS:	5YR GIC ROR	MISC:	SEIX CORE
PRIVATE INVEST:	NASDAQ COMP	CASH:	SEIX CORE

ACCOUNT: R2W0211 SEIX HIGH YIELD

EFFECTIVE DATE: 06/ 03

COMMON STOCK:	S&P 500	CONVERTIBLES:	FB CONV BOND
CASH EQUIV.:	90 DAY T-BILLS	BONDS:	CITI BB&B ALL
MORTGAGES:	CITI MORTGAGE	REAL ESTATE:	NCREIF CL PROP
INTL COMMON STK:	MS EAFE NET	INT'L BONDS:	ML WORLD BOND
STABLE VAL ASTS:	5YR GIC ROR	MISC:	SEIX HIGH YIELD
PRIVATE INVEST:	NASDAQ COMP	CASH:	SEIX HIGH YIELD

ACCOUNT: R2W0209 ALTERNATIVE INVESTMENTS

EFFECTIVE DATE: 06/ 00

COMMON STOCK:	S&P 500	CONVERTIBLES:	FB CONV BOND
CASH EQUIV.:	90 DAY T-BILLS	BONDS:	LB AGGREGATE
MORTGAGES:	CITI MORTGAGE	REAL ESTATE:	NCREIF CL PROP
INTL COMMON STK:	MS EAFE NET	INT'L BONDS:	ML WORLD BOND
STABLE VAL ASTS:	5YR GIC ROR	MISC:	ALT. ASSETS
PRIVATE INVEST:	NASDAQ COMP	CASH:	ALT. ASSETS

VERMONT MUNICIPAL EMPLOYEES

ALLOCATION INDEX DETAIL

ACCOUNT: R2W0210

VERMONT INVESTMENTS

EFFECTIVE DATE: 03/01

COMMON STOCK:	S&P 500	CONVERTIBLES:	FB CONV BOND
CASH EQUIV.:	90 DAY T-BILLS	BONDS:	LB AGGREGATE
MORTGAGES:	CITI MORTGAGE	REAL ESTATE:	NCREIF CL PROP
INTL COMMON STK:	MS EAFE NET	INT'L BONDS:	ML WORLD BOND
STABLE VAL ASTS:	5YR GIC ROR	MISC:	VERMONT INVEST
PRIVATE INVEST:	NASDAQ COMP	CASH:	VERMONT INVEST

VERMONT MUNICIPAL EMPLOYEES
COMMON STOCK HOLDINGS
AS OF 9/05

DELAWARE

<u>COMPANY NAME</u>	<u>SHARES</u>	<u>PRICE</u>	<u>PORT WT</u>	<u>MKT CAP</u>	<u>DIV YLD</u>	<u>P/E</u>	<u>P/B</u>	<u>QUARTER RETURN</u>
CONSUMER DISCRETIONARY STOCK								
DISNEY WALT CO	22400	24.13	1.5	49.46	1.0	17.7	1.8	-4.2
KNIGHT RIDDER INC	11900	58.68	2.0	4.33	2.5	14.0	3.2	-3.8
MCDONALD'S CORP	21100	33.49	2.0	41.86	1.6	17.4	2.9	20.7
NIKE INC	7600	81.68	1.7	21.27	1.2	16.2	3.6	-5.4
VIACOM INC	26100	33.01	2.4	52.34	0.8	N/A	1.3	3.3
			<u>9.6</u>	<u>34.32</u>	<u>1.4</u>	<u>16.3</u>	<u>2.5</u>	<u>2.7</u>
CONSUMER STAPLES STOCK								
ANHEUSER BUSCH COS INC COM	15000	43.04	1.8	33.43	2.5	15.8	11.4	-5.4
ENERGIZER HLDGS INC	5800	56.70	0.9	4.02	0.0	14.0	6.1	-8.8
GILLETTE CO COM	5200	58.20	0.8	53.76	1.2	29.1	15.0	15.3
PEPSICO INC COM	16400	56.71	2.6	94.20	1.8	24.4	6.7	5.6
PROCTER & GAMBLE CO	11600	59.46	1.9	147.04	1.9	21.0	8.5	13.3
WAL MART STORES INC	14600	43.82	1.8	182.41	1.4	17.3	3.8	-8.8
			<u>9.9</u>	<u>97.52</u>	<u>1.7</u>	<u>20.3</u>	<u>8.0</u>	<u>2.0</u>
ENERGY RELATED STOCK								
BP AMOCO P L C	7200	70.85	1.4	254.19	2.8	13.3	3.3	14.4
CHEVRON CORP	10100	64.73	1.8	134.89	2.8	10.7	2.8	16.6
EXXON MOBIL CORP	14084	63.54	2.5	400.62	1.8	13.7	3.8	11.1
MARATHON OIL CORP	7700	68.93	1.5	25.23	1.9	14.5	2.5	29.8
TOTAL S A	3600	135.82	1.4	159.13	2.5	10.4	3.6	16.2
			<u>8.6</u>	<u>216.85</u>	<u>2.3</u>	<u>12.6</u>	<u>3.3</u>	<u>16.9</u>
FINANCIAL STOCK								
AMERICAN EXPRESS CO	13400	57.44	2.2	71.23	0.8	19.1	4.1	7.9

VERMONT MUNICIPAL EMPLOYEES
COMMON STOCK HOLDINGS
AS OF 9/05

DELAWARE

<u>COMPANY NAME</u>	<u>SHARES</u>	<u>PRICE</u>	<u>PORT WT</u>	<u>MKT CAP</u>	<u>DIV YLD</u>	<u>P/E</u>	<u>P/B</u>	<u>QUARTER RETURN</u>
BANK OF AMERICA CORP	32838	42.10	3.9	169.10	4.8	10.2	1.7	-6.6
BANK OF NEW YORK	21400	29.41	1.8	22.67	2.9	15.3	2.4	2.9
CITIGROUP INC	32600	45.52	4.2	235.34	3.9	11.4	2.1	-0.5
J P MORGAN CHASE & CO	24996	33.93	2.4	119.23	4.0	19.0	1.1	-3.0
MBNA CORP	14200	24.64	1.0	30.99	2.3	14.6	2.4	-5.3
MELLON FINL CORP	12300	31.97	1.1	13.37	2.5	15.0	3.2	12.2
MERRILL LYNCH & CO INC	18900	61.35	3.2	56.83	1.3	12.5	1.8	11.9
MORGAN STANLEY DEAN WITTER	24000	53.94	3.6	58.40	2.0	12.3	2.1	3.3
PMI GROUP INC	13300	39.87	1.5	3.66	0.5	9.7	1.1	2.4
PNC FINL SVCS GROUP INC	9400	58.02	1.5	16.88	3.4	13.6	2.0	7.5
PROGRESSIVE CORP OHIO COM	3700	104.77	1.1	20.71	0.1	13.3	3.7	6.1
PRUDENTIAL FINL INC	9200	67.56	1.7	34.82	0.9	13.8	1.5	2.9
US BANCORP DEL	795	28.08	0.1	51.35	4.3	12.1	2.6	-2.8
WACHOVIA CORP	8900	47.59	1.2	75.05	4.3	11.8	1.6	-3.1
			<u>30.4</u>	<u>90.80</u>	<u>2.6</u>	<u>13.3</u>	<u>2.1</u>	<u>2.3</u>
HEALTH CARE STOCK								
CIGNA CORP COM USD1	4800	117.86	1.6	15.15	0.1	9.3	2.6	10.1
GLAXO SMITHKLINE PLC	14100	51.28	2.0	145.43	3.0	17.5	12.4	6.5
PFIZER INC	56000	24.97	3.9	184.04	3.0	18.6	2.8	-8.8
WYETH	20300	46.27	2.6	62.09	2.0	35.9	5.8	4.5
			<u>10.2</u>	<u>118.45</u>	<u>2.3</u>	<u>21.4</u>	<u>5.5</u>	<u>0.7</u>
INDUSTRIALS STOCK								
ARAMARK CORP	14400	26.71	1.1	4.86	0.8	17.7	3.9	1.4
AVERY DENNISON CORP	5700	52.39	0.8	5.25	2.9	17.1	3.4	-0.4
CATERPILLAR INC	6700	58.75	1.1	39.76	1.7	16.8	5.2	23.9

VERMONT MUNICIPAL EMPLOYEES
COMMON STOCK HOLDINGS
AS OF 9/05

DELAWARE

<u>COMPANY NAME</u>	<u>SHARES</u>	<u>PRICE</u>	<u>PORT WT</u>	<u>MKT CAP</u>	<u>DIV YLD</u>	<u>P/E</u>	<u>P/B</u>	<u>QUARTER RETURN</u>
GENERAL ELEC CO	35400	33.67	3.4	356.93	2.6	19.6	3.2	-2.2
GOODRICH CORP	8100	44.34	1.0	5.39	1.8	25.8	3.8	8.7
HONEYWELL INTL INC	9000	37.50	0.9	32.07	2.2	25.3	2.8	2.9
PITNEY BOWES	8000	41.74	0.9	9.55	3.0	19.0	7.2	-3.5
			<u>9.3</u>	<u>140.10</u>	<u>2.2</u>	<u>20.0</u>	<u>3.9</u>	<u>3.1</u>

INFORMATION TECHNOLOGY STOCK

CISCO SYS INC	38800	17.93	1.9	113.45	0.0	20.4	4.9	-6.1
INTEL CORP	27900	24.65	1.9	150.19	1.3	18.7	4.0	-5.0
MICROSOFT	28500	25.73	2.1	275.57	1.2	22.8	5.7	3.9
NATIONAL SEMICONDUCTOR COR	27500	26.30	2.0	9.00	0.3	24.0	4.6	19.0
ORACLE CORP	26000	12.39	0.9	63.85	0.0	21.8	5.6	-6.1
			<u>8.9</u>	<u>130.07</u>	<u>0.6</u>	<u>21.5</u>	<u>4.9</u>	<u>2.2</u>

MATERIALS STOCK

AIR PRODS & CHEMS INC COM	10600	55.14	1.6	12.31	2.3	17.8	2.7	-8.0
DOW CHEM CO	15600	41.67	1.8	40.19	3.2	9.3	2.9	-5.7
DU PONT E I DE NEMOURS & C	8800	39.17	1.0	38.96	3.8	15.1	3.2	-8.1
INTERNATIONAL PAPER COMPAN	10624	29.80	0.9	14.61	3.4	27.9	1.8	-0.6
			<u>5.3</u>	<u>27.11</u>	<u>3.1</u>	<u>16.1</u>	<u>2.7</u>	<u>-6.0</u>

TELECOMMUNICATIONS SERVICES STOCK

ALLTEL CORP	13200	65.11	2.4	21.31	2.3	15.5	2.4	5.2
BCE INC	26500	27.44	2.1	25.43	4.1	19.7	2.4	17.0
			<u>4.5</u>	<u>23.20</u>	<u>3.1</u>	<u>17.5</u>	<u>2.4</u>	<u>10.6</u>

VERMONT MUNICIPAL EMPLOYEES
COMMON STOCK HOLDINGS
AS OF 9/05

DELAWARE

<u>COMPANY NAME</u>	<u>SHARES</u>	<u>PRICE</u>	<u>PORT WT</u>	<u>MKT CAP</u>	<u>DIV YLD</u>	<u>P/E</u>	<u>P/B</u>	<u>QUARTER RETURN</u>
UTILITIES STOCK								
DOMINION RES INC VA NEW	5100	86.14	1.2	29.37	3.1	21.9	2.7	18.4
EXELON CORP	5300	53.44	0.8	35.84	3.0	18.1	3.6	4.9
FPL GROUP INC	9500	47.60	1.3	18.76	3.0	21.0	2.3	14.1
			<u>3.3</u>	<u>26.84</u>	<u>3.0</u>	<u>20.6</u>	<u>2.8</u>	<u>13.5</u>

VERMONT MUNICIPAL EMPLOYEES
COMMON STOCK HOLDINGS
AS OF 9/05

ALLIANCE LARGE CAP GROWTH FUND

<u>COMPANY NAME</u>	<u>SHARES</u>	<u>PRICE</u>	<u>PORT WT</u>	<u>MKT CAP</u>	<u>DIV YLD</u>	<u>P/E</u>	<u>P/B</u>	<u>QUARTER RETURN</u>
CONSUMER DISCRETIONARY STOCK								
CARNIVAL CORP COM	6139	49.98	0.8	40.18	1.6	18.3	2.5	-8.0
EBAY INC	28332	41.20	3.0	55.76	0.0	58.4	7.4	24.8
GETTY IMAGES INC	877	86.04	0.2	5.30	0.0	42.2	4.7	15.9
HILTON HOTELS CORP	4655	22.32	0.3	8.50	0.7	21.9	3.2	-6.3
LOWES COS INC	18618	64.40	3.1	50.23	0.4	20.4	3.8	10.7
PULTE HOMES INC	8027	42.92	0.9	11.09	0.4	9.1	2.2	2.0
SCRIPPS E W CO NEW	12345	49.97	1.6	8.18	0.9	25.9	3.6	2.6
STARBUCKS CORP	8702	50.10	1.1	19.52	0.0	42.1	8.6	-3.0
TARGET CORP	13019	51.93	1.8	45.94	0.8	21.4	3.4	-4.4
XM SATELLITE RADIO HLDGS I	11940	35.91	1.1	7.48	0.0	N/A	N/M	6.7
			<u>13.9</u>	<u>35.59</u>	<u>0.4</u>	<u>31.6</u>	<u>4.8</u>	<u>7.6</u>
CONSUMER STAPLES STOCK								
COLGATE PALMOLIVE CO	7151	52.79	1.0	27.42	2.2	22.6	N/M	6.4
PROCTER & GAMBLE CO	20440	59.46	3.1	147.04	1.9	21.0	8.5	13.3
WHOLE FOODS MKT INC	2294	134.45	0.8	9.05	0.7	53.1	6.9	14.0
WRIGLEY WM JR CO	1079	71.88	0.2	16.19	1.6	30.2	7.1	4.8
			<u>5.1</u>	<u>97.58</u>	<u>1.8</u>	<u>26.7</u>	<u>8.1</u>	<u>11.7</u>
ENERGY RELATED STOCK								
BAKER HUGHES INC	10861	59.68	1.7	20.29	0.8	28.0	4.7	16.9
HALLIBURTON CO	17809	68.52	3.2	34.74	0.7	29.0	7.4	43.6
NABORS INDUSTRIES LTD	10321	71.83	1.9	11.28	0.0	24.7	3.4	18.5
			<u>6.8</u>	<u>24.49</u>	<u>0.5</u>	<u>27.5</u>	<u>5.6</u>	<u>29.8</u>

VERMONT MUNICIPAL EMPLOYEES
COMMON STOCK HOLDINGS
AS OF 9/05

ALLIANCE LARGE CAP GROWTH FUND

<u>COMPANY NAME</u>	<u>SHARES</u>	<u>PRICE</u>	<u>PORT WT</u>	<u>MKT CAP</u>	<u>DIV YLD</u>	<u>P/E</u>	<u>P/B</u>	<u>QUARTER RETURN</u>
FINANCIAL STOCK								
ACE LTD	11400	47.07	1.4	13.56	1.9	11.7	1.3	5.5
AFLAC INC	8904	45.30	1.0	22.70	1.0	16.5	2.7	4.9
AMERICAN INTL GROUP INC CO	15043	61.96	2.4	160.79	1.0	13.4	1.8	6.9
FRANKLIN RES INC COM	7893	83.96	1.7	21.11	0.5	23.1	4.0	9.2
GOLDMAN SACHS GROUP INC	6037	121.58	1.9	55.14	0.8	11.4	2.1	19.4
LEGG MASON INC	4236	109.69	1.2	12.25	0.7	28.1	4.9	5.5
NORTHERN TRUST CORP	2226	50.55	0.3	11.04	1.7	20.7	3.2	11.3
PROGRESSIVE CORP OHIO COM	4115	104.77	1.1	20.71	0.1	13.3	3.7	6.1
			11.1	55.33	0.9	16.4	2.8	8.9
HEALTH CARE STOCK								
AFFYMETRIX INC	1889	46.23	0.2	2.94	0.0	43.2	9.2	-14.3
ALCON INC	9444	127.88	3.1	39.14	0.8	40.9	N/ M	16.9
AMGEN INC	10996	79.67	2.3	98.07	0.0	35.3	5.0	31.8
CAREMARK RX INC	11873	49.93	1.5	22.28	0.0	28.5	2.9	12.2
GENENTECH INC	14706	84.21	3.2	89.62	0.0	86.8	11.2	4.9
GILEAD SCIENCES INC	15718	48.76	2.0	22.20	0.0	37.8	9.3	10.8
LILLY ELI & CO	5666	53.52	0.8	60.68	2.8	46.5	5.9	-3.3
ST JUDE MED INC COM	24217	46.80	2.9	17.01	0.0	38.5	6.5	7.3
TEVA PHARMACEUTICAL INDS L	21890	33.42	1.9	20.43	0.8	20.8	3.9	7.5
UNITEDHEALTH GROUP INC	19023	56.20	2.8	70.53	0.0	23.8	6.7	7.8
WELLPOINT INC	7285	75.82	1.4	46.50	0.0	23.2	2.3	8.9
ZIMMER HLDGS INC	10388	68.89	1.9	17.03	0.0	24.4	4.0	-9.6
			24.0	47.50	0.3	39.5	6.3	9.5
INDUSTRIALS STOCK								
AMERICAN STD COS INC DEL	8904	46.55	1.1	9.81	1.3	24.8	10.8	11.4

VERMONT MUNICIPAL EMPLOYEES
COMMON STOCK HOLDINGS
AS OF 9/05

ALLIANCE LARGE CAP GROWTH FUND

<u>COMPANY NAME</u>	<u>SHARES</u>	<u>PRICE</u>	<u>PORT WT</u>	<u>MKT CAP</u>	<u>DIV YLD</u>	<u>P/E</u>	<u>P/B</u>	<u>QUARTER RETURN</u>
BOEING COM \$US5	2968	67.95	0.5	53.02	1.5	31.8	4.8	3.3
FASTENAL CO	1147	61.09	0.2	4.61	1.0	30.9	6.4	0.2
GENERAL ELEC CO	35550	33.67	3.1	356.93	2.6	19.6	3.2	-2.2
			4.9	234.88	2.1	22.4	5.1	1.5

INFORMATION TECHNOLOGY STOCK

APPLE COMPUTER INC	28602	53.61	4.0	44.39	0.0	42.2	6.5	45.6
BROADCOM CORP	19354	46.92	2.4	15.79	0.0	76.9	6.2	32.1
CORNING INC	46613	19.33	2.3	28.43	0.0	N/A	5.9	16.3
DELL INC	37237	34.20	3.3	82.59	0.0	24.3	15.0	-13.3
E M C CORP MASS	28197	12.94	0.9	31.19	0.0	28.1	2.6	-5.6
ELECTRONIC ARTS INC	17269	56.89	2.5	17.35	0.0	41.2	5.5	0.5
GOOGLE INC	5815	316.46	4.8	86.50	0.0	86.0	N/M	7.6
JUNIPER NETWORKS INC	45534	23.80	2.8	13.35	0.0	46.7	2.1	-5.5
MARVELL TECHNOLOGY GROUP L	17067	46.11	2.0	13.02	0.0	53.6	4.8	21.4
NETWORK APPLIANCE INC	9242	23.74	0.6	8.73	0.0	36.5	5.2	-16.0
QUALCOMM INC	37709	44.75	4.4	72.85	0.8	36.7	7.0	35.9
YAHOO INC	48165	33.84	4.2	47.57	0.0	29.4	6.2	-2.3
			34.2	47.53	0.1	47.5	6.6	13.1

VERMONT MUNICIPAL EMPLOYEES
COMMON STOCK HOLDINGS
AS OF 9/05

LAZARD SMALL CAP FUND

<u>COMPANY NAME</u>	<u>SHARES</u>	<u>PRICE</u>	<u>PORT WT</u>	<u>MKT CAP</u>	<u>DIV YLD</u>	<u>P/E</u>	<u>P/B</u>	<u>QUARTER RETURN</u>
CONSUMER DISCRETIONARY STOCK								
ADVO INC	10040	31.29	1.2	0.98	1.4	21.7	5.6	-1.4
ALLIANCE GAMING CORP	21729	10.85	0.9	0.55	0.0	N/A	3.1	-22.6
ARBITRON INC	6424	39.84	0.9	1.26	1.0	17.9	13.1	-6.9
CARMIKE CINEMAS INC	4050	22.94	0.3	0.28	3.1	19.6	1.1	-24.7
CBRL GROUP INC	3539	33.66	0.4	1.57	1.4	12.7	1.8	-13.1
CSK AUTO INC	3489	14.88	0.2	0.65	0.0	21.3	3.1	-10.8
DICKS SPORTING GOODS INC	6377	30.11	0.7	1.51	0.0	26.6	4.3	-22.0
FINISH LINE INC	7845	14.59	0.4	0.71	0.7	11.4	1.7	-22.7
FOSSIL INC	6179	18.19	0.4	1.29	0.0	14.1	2.4	-19.9
JOURNAL REGISTER CO	15666	16.18	0.9	0.67	0.5	5.9	3.2	-7.5
LEVITT CORP FLA	7177	22.94	0.6	0.45	0.3	6.8	1.4	-23.3
LIBERTY CORP COM	6228	46.89	1.1	0.86	2.1	20.0	2.7	28.1
PETCO ANIMAL SUPPLIES INC	5082	21.16	0.4	1.22	0.0	14.8	6.9	-27.8
R H DONNELLEY CORP	4397	63.26	1.0	2.01	0.0	N/A	N/A	2.1
RARE HOSPITALITY INTL INC	2887	25.70	0.3	0.87	0.0	18.0	2.1	-15.7
TIMBERLAND CO	6022	33.78	0.8	2.26	0.0	14.3	4.5	-12.8
WMF INDUSTRIES	6591	28.13	0.7	0.89	0.0	40.8	3.1	-16.7
			11.2	1.12	0.7	18.0	4.3	-9.1
CONSUMER STAPLES STOCK								
DELTA & PINE LD CO	6022	26.41	0.6	0.95	2.3	46.3	5.2	6.0
PERFORMANCE FOOD GROUP CO	8414	31.53	1.0	1.50	0.0	34.3	1.4	4.4
			1.6	1.29	0.9	38.8	2.8	5.0
ENERGY RELATED STOCK								
BRIGHAM EXPL CO	16070	12.85	0.8	0.54	0.0	30.6	2.8	40.7

VERMONT MUNICIPAL EMPLOYEES
COMMON STOCK HOLDINGS
AS OF 9/05

LAZARD SMALL CAP FUND

<u>COMPANY NAME</u>	<u>SHARES</u>	<u>PRICE</u>	<u>PORT WT</u>	<u>MKT CAP</u>	<u>DIV YLD</u>	<u>P/E</u>	<u>P/B</u>	<u>QUARTER RETURN</u>
DENBURY RES INC DEL	3234	50.44	0.6	2.88	0.0	25.1	4.6	26.8
DRESSER-RAND GROUP INC COM	11830	24.63	1.1	1.34	0.0	79.5	3.1	
ENERGY PARTNERS LTD	7202	31.22	0.8	1.17	0.0	18.2	3.3	19.1
FOREST OIL CORP	3160	52.10	0.6	3.23	0.0	18.8	2.1	24.0
GREY WOLF INC	26538	8.43	0.8	1.62	0.0	23.4	5.5	13.8
KEY ENERGY GROUP INC	17942	14.75	1.0	1.93	0.0	N/A	N/A	21.9
KINDER MORGAN MGMT LLC	4680	49.56	0.9	2.78	0.0	33.3	1.9	9.5
MAVERICK TUBE CORP	3679	30.00	0.4	1.29	0.0	7.6	1.9	0.7
N S GROUP INC COM	635	39.25	0.1	0.88	0.0	8.1	3.7	20.7
OIL STS INTL INC	4100	36.31	0.5	1.78	0.0	22.3	3.2	44.3
OMI CORP NEW	19865	17.87	1.3	1.48	1.7	5.6	1.8	-5.6
RANGE RES CORP	5205	38.61	0.7	3.27	0.2	43.4	4.8	43.6
TODCO	5337	41.71	0.8	2.62	0.0	122.7	5.2	67.6
VERITAS DOC INC	5387	36.62	0.7	1.23	0.0	27.1	2.3	32.0
			11.2	1.89	0.2	36.7	3.3	24.6

FINANCIAL STOCK

ALEXANDRIA REAL ESTATE EQU	2376	82.69	0.7	1.75	3.3	35.5	3.3	13.5
ARCH CAPITAL GROUP LTD	5651	49.59	1.0	1.75	0.0	4.6	0.7	10.1
ASSURED GUARANTY LTD COM	9440	23.93	0.8	1.78	0.5	8.8	1.1	2.6
BANK OF THE OZARKS INC	7350	34.33	0.9	0.57	1.2	19.7	4.1	4.8
BANKUNITED FINL CORP CLASS	11491	22.87	1.0	0.69	0.1	25.4	1.4	-15.4
BIOMED RLTY TR INC	5915	24.80	0.5	1.15	4.4	67.0	1.6	5.1
BOSTON PRIVATE FINL HLDGS	5857	26.54	0.6	0.75	1.1	18.8	2.2	5.6
BRANDYWINE RLTY TR	5057	31.09	0.6	1.73	5.7	43.8	1.5	2.9
BRISTOL WEST HLDGS INC	12448	18.25	0.8	0.57	1.5	9.4	1.7	0.2
CAPITAL AUTOMOTIVE REIT	4974	38.71	0.7	1.79	4.6	23.5	1.8	2.7
COUSINS PROPERTIES INC COM	4529	30.22	0.5	1.52	4.9	5.5	3.4	3.5

VERMONT MUNICIPAL EMPLOYEES
COMMON STOCK HOLDINGS
AS OF 9/05

LAZARD SMALL CAP FUND

<u>COMPANY NAME</u>	<u>SHARES</u>	<u>PRICE</u>	<u>PORT WT</u>	<u>MKT CAP</u>	<u>DIV YLD</u>	<u>P/E</u>	<u>P/B</u>	<u>QUARTER RETURN</u>
FINANCIAL FEDERAL CORP	4554	39.80	0.7	0.69	1.0	18.5	2.0	3.3
FIRST CMNTY BANCORP CALIF	4224	47.83	0.7	0.79	2.1	17.8	2.0	1.2
FIRST MIDWEST BANCORP INC	5255	37.24	0.7	1.69	2.7	16.9	3.1	6.9
LEXINGTON CORPORATE PPTYS	6154	23.55	0.5	1.16	6.1	38.6	1.8	-1.7
MAF BANCORP INC	627	40.98	0.1	1.31	2.2	13.4	1.4	-3.3
MB FINANCIAL INC	7037	38.98	1.0	1.11	1.5	16.0	2.3	-1.7
MILLS CORP	2178	55.08	0.4	3.10	4.6	37.5	7.1	-8.5
PRENTISS PPTYS TR	2739	40.60	0.4	1.83	5.5	48.3	2.2	13.0
PROVIDENT BANKSHARES CORP	4496	34.78	0.6	1.14	3.2	15.6	1.8	9.9
SCOTTISH ANNUITY REGROUP L	7631	23.84	0.7	1.08	0.8	13.4	1.1	-1.4
SOUTH FINL GROUP INC	4446	26.84	0.4	2.00	2.4	15.9	1.3	-5.0
STERLING BANCSHARES INC	13842	14.70	0.8	0.67	1.6	23.0	2.0	-5.2
TEXAS REGL BANCSHARES INC	9437	28.79	1.0	1.43	1.7	16.5	2.3	-5.1
UMPQUA HLDGS CORP	8126	24.32	0.7	1.08	1.3	18.9	1.5	3.7
UNITED BANKSHARES INC	3910	34.95	0.5	1.49	3.0	17.2	2.3	-1.1
			17.6	1.27	2.3	21.3	2.1	1.5

HEALTH CARE STOCK

ADVANCED MED OPTICS INC	5321	37.95	0.7	2.49	0.0	N/ A	2.5	-4.5
ALDERWOODS GROUP INC	6039	16.38	0.4	0.66	0.0	78.0	1.1	14.1
AMERIGROUP CORP	7202	19.12	0.5	0.98	0.0	10.8	1.6	-52.4
BIOSCRIP INC COM	29723	6.50	0.7	0.23	0.0	92.9	1.0	8.3
CANDELA CORP	5007	9.82	0.2	0.22	0.0	33.9	3.0	-6.0
CONNETICS CORP	11359	16.91	0.7	0.59	0.0	45.7	5.8	-4.1
FIRST HORIZON PHARMACEUTIC	9767	19.87	0.7	0.70	0.0	22.3	2.2	4.4
GENTIVA HEALTH SERVICES IN	2656	18.12	0.2	0.42	0.0	17.8	2.4	1.5
HANGER ORTHOPEDIC CORP	23280	7.70	0.7	0.17	0.0	N/ A	1.1	52.8
K V PHARMACEUTICAL CO	6765	17.77	0.4	0.88	0.0	N/ M	3.2	6.1

VERMONT MUNICIPAL EMPLOYEES
COMMON STOCK HOLDINGS
AS OF 9/05

LAZARD SMALL CAP FUND

<u>COMPANY NAME</u>	<u>SHARES</u>	<u>PRICE</u>	<u>PORT WT</u>	<u>MKT CAP</u>	<u>DIV YLD</u>	<u>P/E</u>	<u>P/B</u>	<u>QUARTER RETURN</u>
KINDRED HEALTHCARE INC	8769	29.80	1.0	1.15	0.0	8.6	1.4	-24.8
LIFEPOINT HOSPS INC	7086	43.73	1.1	2.49	0.0	26.0	2.0	-13.5
MATTHEWS INTL CORP CLASS A	3588	37.80	0.5	1.21	0.5	20.1	3.7	-2.9
PSS WORLD MED INC	16433	13.34	0.8	0.87	0.0	20.5	3.0	7.1
SYMMETRY MED INC COM	11854	23.70	1.0	0.79	0.0	45.6	3.5	0.7
TARO PHARMACEUTICAL INDS L	11128	25.73	1.1	0.75	0.0	37.3	2.0	-11.5
VENTIV HEALTH INC	5329	26.21	0.5	0.70	0.0	17.5	3.4	35.9
			11.2	1.03	0.0	33.9	2.5	-0.9

INDUSTRIALS STOCK

ACUITY BRANDS INC	4314	29.67	0.5	1.31	2.0	24.5	2.4	16.2
AIRTRAN HLDGS INC	22100	12.66	1.0	1.10	0.0	N/A	3.2	37.2
APPLIED SIGNAL TECHNOLOGY	11780	19.08	0.8	0.22	2.6	25.1	2.3	0.8
DRS TECHNOLOGIES INC	3877	49.36	0.7	1.37	0.2	21.9	2.0	-3.7
ENGINEERED SUPPORT SYS INC	3341	41.04	0.5	1.71	0.1	19.8	3.8	14.5
ESTERLINE CORP	6682	37.89	0.9	0.96	0.0	16.8	1.6	-5.5
FEDERAL SIGNAL CORP	7573	17.09	0.5	0.83	1.4	N/A	2.0	9.9
HUB GROUP INC	5478	36.71	0.7	0.73	0.0	30.7	3.4	46.5
KENNAMETAL INC COM	4521	49.04	0.8	1.87	1.5	15.2	1.9	7.4
KNOLL INC	7779	18.35	0.5	0.94	1.1	28.7	N/M	7.5
LADISH INC	4851	17.44	0.3	0.24	0.0	25.6	1.8	74.6
LEARNING TREE INTERNATIONAL	15798	13.20	0.8	0.22	0.0	N/M	3.3	10.9
MIDDLEBY CORP	2178	72.50	0.6	0.57	0.0	23.5	N/M	37.2
MILLER HERMAN INC COM	4479	30.30	0.5	2.11	1.0	27.3	11.9	-1.5
PACER INTL INC TENN	10914	26.36	1.1	0.99	2.3	22.2	3.5	21.7
RBC BEARINGS INC COM	7721	15.95	0.5	0.26	0.0	15.0	N/A	
REGAL BELOIT CORP COM	6905	32.44	0.8	0.94	1.6	18.9	1.7	11.7
RUSH ENTERPRISES INC	2153	15.28	0.1	0.37	0.0	10.5	1.5	14.0

VERMONT MUNICIPAL EMPLOYEES
COMMON STOCK HOLDINGS
AS OF 9/05

LAZARD SMALL CAP FUND

<u>COMPANY NAME</u>	<u>SHARES</u>	<u>PRICE</u>	<u>PORT WT</u>	<u>MKT CAP</u>	<u>DIV YLD</u>	<u>P/E</u>	<u>P/B</u>	<u>QUARTER RETURN</u>
SOTHEBYS HLDGS INC	5511	16.72	0.3	1.07	0.0	26.1	4.0	22.0
SWIFT TRANSN INC	6278	17.70	0.4	1.28	0.0	11.8	1.6	-24.0
TETRA TECH INC NEW	11524	16.82	0.7	0.96	0.0	N/A	3.3	24.3
UNITED RENTALS INC	10996	19.71	0.8	1.54	0.0	N/A	1.5	-2.5
WABASH NATL CORP	10155	19.66	0.7	0.61	0.9	5.9	2.6	-18.7
WASTE CONNECTIONS INC	4215	35.08	0.5	1.64	0.0	21.1	2.3	-5.9
WATSON WYATT & CO HLDGS	9825	26.95	1.0	0.88	1.1	17.1	3.8	5.4
WESCO INTL INC	8274	33.87	1.0	1.59	0.0	20.2	3.9	7.9
			17.2	1.04	0.7	20.4	3.0	11.5

INFORMATION TECHNOLOGY STOCK

ACTEL CORP	14560	14.46	0.8	0.37	0.0	N/M	1.4	4.0
ADE CORP MASS	5082	22.48	0.4	0.32	0.0	8.2	2.4	-19.9
AGILE SOFTWARE CORP DE	10106	7.17	0.3	0.38	0.0	N/A	1.5	13.8
AVOCENT CORP	6303	31.64	0.7	1.55	0.0	43.9	2.3	21.0
BEARINGPOINT INC	2681	7.59	0.1	1.51	0.0	N/A	1.3	3.5
BENCHMARK ELECTRS INC	9400	30.12	1.0	1.26	0.0	16.8	1.6	-1.0
BISYS GROUP INC	14263	13.43	0.7	1.61	0.0	20.0	2.0	-10.1
BROOKS AUTOMATION INC NEW	10346	13.33	0.5	0.60	0.0	66.6	1.9	-10.2
C COR ELECTRONICS INC COM	27792	6.75	0.7	0.32	0.0	N/A	1.5	-1.5
COHERENT INC COM	8002	29.28	0.9	0.91	0.0	20.2	1.5	-18.7
COMMSCOPE INC	7193	17.34	0.5	0.95	0.0	31.5	2.0	-0.4
DOT HILL SYS CORP	31100	6.73	0.8	0.29	0.0	23.2	1.5	28.4
EXAR CORP	19064	14.02	1.0	0.59	0.0	100.1	1.2	-5.8
INTEGRATED DEVICE TECHNOLO	30680	10.74	1.2	1.16	0.0	46.7	1.4	-0.1
MICROSEMI CORP	5733	25.54	0.5	1.60	0.0	70.9	7.3	35.9
MPS GROUP INC	23098	11.80	1.0	1.19	0.0	28.1	1.4	25.3
OPLINK COMMUNICATIONS INC	26918	1.52	0.2	0.23	0.0	N/A	1.0	-7.9

VERMONT MUNICIPAL EMPLOYEES
COMMON STOCK HOLDINGS
AS OF 9/05

LAZARD SMALL CAP FUND

<u>COMPANY NAME</u>	<u>SHARES</u>	<u>PRICE</u>	<u>PORT WT</u>	<u>MKT CAP</u>	<u>DIV YLD</u>	<u>P/E</u>	<u>P/B</u>	<u>QUARTER RETURN</u>
PHOTON DYNAMICS INC	8909	19.15	0.6	0.33	0.0	N/A	2.2	-7.1
POLYCOM INC	14544	16.17	0.9	1.56	0.0	28.9	1.6	8.5
ROGERS CORP COM	6228	38.70	0.9	0.63	0.0	52.3	2.4	-4.6
SAFENET INC	9041	36.31	1.2	0.90	0.0	N/A	1.5	6.6
SECURE COMPUTING CORP	13438	11.35	0.6	0.41	0.0	23.6	4.0	4.3
SERENA SOFTWARE INC	11904	19.93	0.9	0.82	0.0	27.7	3.0	3.3
TTM TECHNOLOGIES INC	26208	7.15	0.7	0.30	0.0	12.8	1.3	-6.0
WEBEX INC	5585	24.51	0.5	1.13	0.0	20.3	3.9	-7.2
WRIGHT EXPRESS CORP	9833	21.59	0.8	0.87	0.0	N/A	N/M	16.9
ZORAN CORP	11739	14.30	0.6	0.64	0.0	N/A	1.3	7.6
			<u>18.9</u>	<u>0.87</u>		<u>36.7</u>	<u>2.0</u>	<u>3.5</u>

MATERIALS STOCK

CLEVELAND CLIFFS INC COM	3151	87.11	1.0	1.91	0.9	4.7	3.6	51.2
OLIN CORP COM	10873	18.99	0.8	1.36	4.2	12.0	3.3	5.3
OREGON STL MLS INC	11854	27.90	1.2	0.99	0.0	5.8	2.0	62.1
POLYONE CORPORATION-W/I	18520	6.06	0.4	0.56	0.0	12.9	1.3	-8.5
RTI INTL METALS INC	9883	39.35	1.4	0.88	0.0	64.5	2.5	25.3
SCOTTS MIRACLE GRO CO	1468	87.93	0.5	2.95	1.1	27.3	2.9	23.9
SPARTECH CORP	6839	19.54	0.5	0.62	2.5	39.1	1.5	9.8
STEEL DYNAMICS INC	8728	33.96	1.1	1.47	1.2	5.3	1.9	29.8
TEXAS INDS INC COM	2071	54.40	0.4	1.24	0.6	40.9	1.3	28.6
WESTLAKE CHEM CORP	6798	27.08	0.7	1.76	0.4	9.3	2.0	10.6
			<u>8.0</u>	<u>1.34</u>	<u>1.0</u>	<u>22.5</u>	<u>2.3</u>	<u>29.0</u>

TELECOMMUNICATIONS SERVICES STOCK

WIRELESS FACS INC	32569	5.80	0.7	0.42	0.0	82.9	1.8	-8.4
			<u>0.7</u>	<u>0.42</u>		<u>82.9</u>	<u>1.8</u>	<u>-8.4</u>

VERMONT MUNICIPAL EMPLOYEES
COMMON STOCK HOLDINGS
AS OF 9/05

LAZARD SMALL CAP FUND

<u>COMPANY NAME</u>	<u>SHARES</u>	<u>PRICE</u>	<u>PORT WT</u>	<u>MKT CAP</u>	<u>DIV YLD</u>	<u>P/E</u>	<u>P/B</u>	<u>QUARTER RETURN</u>
UTILITIES STOCK								
AGL RES INC	3671	37.11	0.5	2.87	3.3	15.5	2.0	-3.2
CLECO CORP NEW	11343	23.58	1.0	1.18	3.8	16.6	2.1	10.4
NEW JERSEY RES CORP COM	3226	45.98	0.5	1.26	3.0	16.2	2.4	-4.0
			2.0	1.62	3.5	16.2	2.2	3.2

VERMONT MUNICIPAL EMPLOYEES

BOND HOLDINGS

AS OF 9/05

SEIX CORE

	<u>BOND NAME</u>	<u>MARKET VALUE</u>	<u>COUPON</u>	<u>STATED MATURITY</u>	<u>MOODY RATE</u>	<u>DUR-ATION</u>	<u>YIELD TO MATURITY</u>
0-5 YEARS	BA_MTG_CC_2001-A- A	466,129	3.89	6/15/08	AAA	0.04	3.88%
	BNP US FDG 144A	130,696	7.74	12/05/07	A1	1.96	4.92%
	DEERE JOHN CAP CORP	64,612	3.90	1/15/08	A3	2.15	4.63%
	HARLEY DAVIDSON FDG MTN 14	63,107	3.63	12/15/08	A1	2.96	4.66%
	HSBC HLDGS PLC 7.625%	109,583	7.63	5/17/05		N/A	N/A
	MOLSON COORS CAP 144A	64,377	4.85	9/22/10	BAA2	4.36	5.03%
	NCR CORP NEW	37,698	7.13	6/15/09	BAA3	3.19	5.31%
	NORTHERN STATES PWR MN	44,617	2.88	8/01/06	A2	0.81	4.41%
	PANHANDLE EASTERN PL	70,016	4.80	8/15/08	BAA3	2.64	4.88%
	PANHANDLE EASTERN PL	38,857	2.75	3/15/07	BAA3	1.40	4.77%
	PENNZENERGY CO	26,198	10.25	11/01/05	BAA2	0.09	5.30%
	PUB SVC COLO	116,216	4.38	10/01/08	A3	2.72	4.73%
	SIMON PPTY GROUP	52,834	6.38	11/15/07	BAA1	1.93	4.88%
	UNITED STATES TREAS NTS	1,190,953	4.13	8/15/10	GOVT	4.35	4.22%
	UNITED STATES TREAS NTS	3,127,610	5.63	5/15/08	GOVT	2.38	4.19%
	UNITED STATES TREAS NTS	2,600,066	4.00	8/31/07	GOVT	1.82	4.19%
	UNITED STATES TREAS NTS	8,615,219	3.13	5/15/07	GOVT	1.54	4.17%
	UNITED STATES TREAS NTS	1,655,268	1.88	11/30/05	GOVT	0.16	3.89%
	UNITED STATES TREAS NTS	1,769,447	1.63	10/31/05	GOVT	0.08	3.89%
	UNITED STATES TREAS NTS	586,257	1.88	12/31/05	GOVT	0.25	3.62%
UNITED STATES TREAS NTS	7,485,333	6.00	8/15/09	GOVT	3.43	4.21%	
UNITED STATES TREAS NTS	281,055	4.13	8/15/08	GOVT	2.67	4.18%	
	<u>28,596,148</u>		<u>4.17</u>			<u>2.08</u>	<u>4.15%</u>
5-10 YEARS	BANK OF AMERICA	238,523	7.40	1/15/11	AA3	4.36	4.87%
	CENTERPOINT ENERGY RES	143,037	7.88	4/01/13	BAA3	5.61	5.36%
	CIT GROUP INC	169,259	5.13	9/30/14	A2	7.14	5.18%
	CITIGROUP INC	92,384	5.13	5/05/14	AA1	6.76	4.96%

VERMONT MUNICIPAL EMPLOYEES

BOND HOLDINGS

AS OF 9/05

SEIX CORE

	<u>BOND NAME</u>	<u>MARKET VALUE</u>	<u>COUPON</u>	<u>STATED MATURITY</u>	<u>MOODY RATE</u>	<u>DUR-ATION</u>	<u>YIELD TO MATURITY</u>
	COMCAST CABLE	227,336	7.13	6/15/13	BAA2	5.90	5.32%
	CORPORACION NACIONAL DEL C	115,727	5.50	10/15/13	A2	N/A	N/A
	COX COMMUNICATIONS INC	100,802	4.63	6/01/13	BAA3	6.24	5.49%
	CREDIT SUISSE FIRST BOSTON	104,236	6.50	1/15/12	AA3	N/A	N/A
	ERAC USA FIN CO 144A	81,780	5.60	5/01/15	BAA1	7.18	5.46%
	FUND AMERN COS	230,016	5.88	5/15/13	BAA2	5.97	5.87%
	GENL ELEC CO	411,210	5.00	2/01/13	AAA	6.06	4.86%
	GOLDMAN SACHS GROUP	247,057	4.75	7/15/13	AA3	6.37	5.11%
	GTECH HLDGS CORP	55,974	4.75	10/15/10	BAA1	4.29	6.80%
	HARRAHS OPER INC	65,099	5.38	12/15/13	BAA3	6.46	5.58%
	LAZARD GROUP LLC 144A	372,594	7.13	5/15/15	BA1	6.68	7.23%
	MORGAN STANLEY GROUP	329,848	5.30	3/01/13	AA3	6.06	5.14%
	MOTIVA ENTERPRISES LLC 144	76,553	5.20	9/15/12	A2	5.78	5.12%
	NEWS AMERICA HLDGS INC	119,246	9.25	2/01/13	BAA3	5.49	5.33%
	TII 1 5/8	1,978,929	1.63	1/15/15		N/A	N/A
	UNITED STATES TREAS BONDS	1,238,811	4.25	8/15/15	GOVT	7.95	4.33%
	UNITED STATES TREAS NTS	1,383,872	4.25	11/15/14	GOVT	7.38	4.35%
	UNITED STATES TREAS NTS	4,237,799	4.25	8/15/13	GOVT	6.60	4.30%
	UNITED TECHNOLOGIES	167,967	4.88	5/01/15	A2	7.42	4.89%
		<u>12,188,059</u>	<u>4.30</u>			<u>6.73</u>	<u>4.67%</u>
10-20 YEARS	FHLMC GOLD POOL - B10460	194,259	4.50	10/01/18	GOVT	3.48	5.05%
	FHLMC GOLD POOL - G11606	920,397	4.50	5/01/18	GOVT	3.33	5.05%
	FNCI TBA	889,413	5.00	9/30/18	GOVT	N/A	N/A
	FNMA POOL - 713567	87,591	5.50	4/01/18	GOVT	1.88	4.95%
	FNMA POOL - 785268	454,152	5.50	7/01/19	GOVT	2.45	5.00%
	FNMA POOL - 793044	243,966	5.00	8/01/19	GOVT	3.04	5.02%
	FNMA POOL - 793480	263,697	5.00	8/01/19	GOVT	3.03	5.02%

VERMONT MUNICIPAL EMPLOYEES

BOND HOLDINGS

AS OF 9/05

SEIX CORE

	<u>BOND NAME</u>	<u>MARKET VALUE</u>	<u>COUPON</u>	<u>STATED MATURITY</u>	<u>MOODY RATE</u>	<u>DUR-ATION</u>	<u>YIELD TO MATURITY</u>
	FNMA POOL - 794330	164,408	5.00	9/01/19	GOVT	3.07	5.02%
	FNMA POOL - 794439	184,268	5.00	10/01/19	GOVT	3.08	5.02%
	INCO LTD	167,469	5.70	10/15/15	BAA3	7.41	5.38%
	SOUTHWEST AIRLINES	90,955	5.13	3/01/17		N/A	N/A
	TELECOM ITALIA CAPITAL	220,238	5.25	10/01/15	24	N/A	N/A
		3,880,813	4.97			3.31	5.05%
OVER 20 YEARS	AOL TIME WARNER	210,763	7.63	4/15/31	BAA1	12.12	6.27%
	CITIGROUP INC	117,246	5.85	12/11/34	AA1	14.20	5.53%
	COMCAST CORP NEW	27,878	7.05	3/15/33	BAA2	13.04	6.19%
	DAIMLERCHRYSLER NA CORP	60,497	8.50	1/18/31	A3	12.31	6.75%
	DELTA_FND_1999-003- A1F	7,469	7.46	9/15/29	AAA	4.40	7.82%
	DEVON FING CORP	152,114	7.88	9/30/31	BAA2	12.51	5.91%
	ENTERPRISE PRODUCTS	85,394	6.88	3/01/33	BAA3	13.13	6.44%
	EQCC_HEL_1999-003- A7F	19,318	7.45	8/25/29	AAA	1.79	7.90%
	EXELON CORP	257,648	5.63	6/15/35	BAA2	13.96	6.22%
	FEDERATED DEPT STORES	49,892	6.90	4/01/29	BAA1	11.85	6.26%
	FHLMC GOLD POOL - A11080	231,710	5.00	7/01/33	GOVT	4.52	5.42%
	FHLMC GOLD POOL - A13482	35,219	6.00	9/01/33	GOVT	1.97	5.29%
	FHLMC GOLD POOL - A16521	157,422	6.00	12/01/33	GOVT	1.92	5.29%
	FHLMC GOLD POOL - A17597	177,115	6.00	1/01/34	GOVT	2.06	5.35%
	FHLMC GOLD POOL - A22067	185,537	6.50	5/01/34	GOVT	1.11	4.93%
	FHLMC GOLD POOL - A24756	148,152	6.00	7/01/34	GOVT	2.18	5.35%
	FHLMC GOLD POOL - A46697	684,668	4.50	8/01/35	GOVT	5.46	5.37%
	FHLMC GOLD POOL - C01672	660,274	6.00	10/01/33	GOVT	2.05	5.29%
	FHLMC GOLD POOL - C61720	261,018	6.00	12/01/31	GOVT	2.15	5.31%
	FHLMC GOLD POOL - C69011	148,523	6.50	7/01/32	GOVT	1.39	5.17%
	FHLMC GOLD POOL - C76371	534,928	5.00	2/01/33	GOVT	4.24	5.42%

VERMONT MUNICIPAL EMPLOYEES

BOND HOLDINGS

AS OF 9/05

SEIX CORE

<u>BOND NAME</u>	<u>MARKET VALUE</u>	<u>COUPON</u>	<u>STATED MATURITY</u>	<u>MOODY RATE</u>	<u>DUR- ATION</u>	<u>YIELD TO MATURITY</u>
FHLMC GOLD POOL - C79584	206,623	5.50	5/01/33	GOVT	3.24	5.48%
FHLMC_T-049- AV	31,130	4.02	12/25/32	GOVT	0.07	4.04%
FNMA POOL - 254263	81,220	6.50	4/01/32	GOVT	1.68	5.04%
FNMA POOL - 254767	661,353	5.50	6/01/33	GOVT	3.36	5.46%
FNMA POOL - 535899	90,196	6.00	4/01/31	GOVT	2.39	5.28%
FNMA POOL - 687692	182,347	5.50	3/01/33	GOVT	3.36	5.46%
FNMA POOL - 688251	519,336	5.50	2/01/33	GOVT	3.63	5.46%
FNMA POOL - 689022	466,141	5.00	5/01/33	GOVT	4.47	5.38%
FNMA POOL - 698156	237,139	5.50	4/01/33	GOVT	3.38	5.46%
FNMA POOL - 725314	1,207,221	5.00	4/01/34	GOVT	4.49	5.39%
FNMA POOL - 728734	790,677	5.50	7/01/33	GOVT	3.34	5.46%
FNMA POOL - 743541	647,605	5.50	11/01/33	GOVT	2.87	5.46%
FNMA POOL - 747536	671,418	5.00	11/01/33	GOVT	4.70	5.38%
FNMA POOL - 748109	110,488	6.50	10/01/33	GOVT	0.80	4.69%
FNMA POOL - 751810	84,242	6.50	10/01/33	GOVT	0.90	4.69%
FNMA POOL - 753514	126,572	6.00	11/01/33	GOVT	1.88	5.24%
FNMA POOL - 753994	48,194	6.00	12/01/33	GOVT	1.86	5.24%
FNMA POOL - 755813	52,961	6.50	11/01/33	GOVT	0.93	4.69%
FNMA POOL - 769820	88,153	6.00	3/01/34	GOVT	2.00	5.29%
FNMA POOL - 770327	107,672	6.00	4/01/34	GOVT	1.88	5.29%
FNMA POOL - 770439	80,791	6.00	4/01/34	GOVT	1.88	5.29%
FNMA POOL - 772255	60,764	6.00	11/01/33	GOVT	1.79	5.24%
FNMA POOL - 775075	123,411	6.00	5/01/34	GOVT	1.95	5.29%
FNMA POOL - 787810	138,147	6.50	7/01/34	GOVT	0.89	4.71%
FNMA_2002-T10- IA1	45,758	3.95	6/25/32	AAA	0.07	4.05%
FNMA_2002-T13- A	56,866	3.93	8/25/32	GOVT	0.07	4.00%
FRANCE TELECOM	80,874	10.00	3/01/31	BAA3	N/A	N/A
GNMA POOL - 604012	629,180	5.50	2/15/33	GOVT	3.80	5.31%

VERMONT MUNICIPAL EMPLOYEES

BOND HOLDINGS

AS OF 9/05

SEIX CORE

<u>BOND NAME</u>	<u>MARKET VALUE</u>	<u>COUPON</u>	<u>STATED MATURITY</u>	<u>MOODY RATE</u>	<u>DUR- ATION</u>	<u>YIELD TO MATURITY</u>
K N CAP TR III	119,408	7.63	4/15/28	BAA3	11.45	6.52%
K N ENERGY	57,447	7.25	3/01/28	BAA2	11.82	6.09%
METLIFE INC	45,590	5.70	6/15/35	A2	14.31	5.74%
NEWS AMER 6.2% 12/15/34	56,054	6.20	12/15/34		N/A	N/A
NEW_CENTURY_1999-NCB- A7	19,936	7.54	9/25/29	AAA	0.93	7.51%
PAC G&E	182,287	6.05	3/01/34	BAA1	13.71	5.76%
SBC COMMUNICATIONS INC	91,374	6.45	6/15/34	A2	13.76	6.03%
SOUNDVIEW_HEL_2001-01- A	6,415	6.26	4/15/31	AAA	4.89	6.38%
UNITED STATES TREAS BONDS	4,211,213	5.38	2/15/31	GOVT	14.30	4.57%
VERIZON GLOBAL	198,437	7.75	12/01/30	A2	12.44	6.05%
	<u>16,827,425</u>	<u>5.60</u>			<u>7.06</u>	<u>5.22%</u>

VERMONT MUNICIPAL EMPLOYEES

BOND HOLDINGS

AS OF 9/05

SEIX HIGH YIELD

	<u>BOND NAME</u>	<u>MARKET VALUE</u>	<u>COUPON</u>	<u>STATED MATURITY</u>	<u>MOODY RATE</u>	<u>DUR-ATION</u>	<u>YIELD TO MATURITY</u>
0-5 YEARS	AES CORP	38,284	9.38	9/15/10	B1	3.98	6.90%
	AMERIGAS PARTNERS L P	11,202	10.00	4/15/06	B2	0.50	6.18%
	BALL CORP	6,758	7.75	8/01/06	BA2	0.79	5.56%
	CABLEVISION SYS CORP	41,060	7.88	4/01/09	B3	0.14	7.64%
	CANANDAIGUA BRANDS INC	46,528	8.63	8/01/06	BA2	0.79	5.51%
	CAPITOL RECORDS INC 144A	66,427	8.38	8/15/09	BA1	3.28	6.17%
	CB RICHARD ELLIS SVCS INC	28,436	9.75	5/15/10	BA3	1.62	5.93%
	CHUMASH CASINO & RESORT E	34,391	9.00	7/15/10	BA3	0.98	5.46%
	CITGO PETE CORP	6,582	7.88	5/15/06	BA1	0.59	5.39%
	CITIZENS COMM	55,097	7.63	8/15/08	BA3	2.55	5.62%
	DEAN FOODS CO	90,250	8.15	8/01/07	BA2	1.68	5.67%
	ECHOSTAR DBS CORP	12,109	9.13	1/15/09	BA3	0.95	6.32%
	EDISON MISSION ENERGY	44,138	7.73	6/15/09	B1	3.14	6.05%
	EDISON MISSION ENERGY	5,676	10.00	8/15/08	B1	2.49	5.88%
	EL PASO NAT GAS	31,375	7.63	8/01/10	B1	3.10	6.43%
	EQUISTAR CHEMICALS	16,135	10.13	9/01/08	B2	2.51	7.22%
	ETHYL CORP	26,710	8.88	5/01/10	B2	2.75	7.30%
	FOREST OIL CORP	51,992	8.00	6/15/08	BA3	2.38	5.53%
	GEORGIA PACIFIC	133,029	8.88	2/01/10	BA1	3.59	5.83%
	GEORGIA PACIFIC	53,465	7.38	7/15/08	BA1	2.47	5.51%
	HCA INC	23,870	5.50	12/01/09	BA2	3.60	6.06%
	HCA INC	76,388	8.75	9/01/10	BA2	4.00	6.25%
	HERCULES INC	17,415	11.13	11/15/07	BA2	1.85	4.86%
	HOST MARRIOTT L P	82,565	9.50	1/15/07	BA3	1.19	5.72%
	HOST MARRIOTT L P	31,940	9.25	10/01/07	BA3	1.74	6.35%
	HUNTSMAN INTL LLC	10,771	9.88	3/01/09	B2	1.45	7.77%
	IPALCO ENTERPRISES	55,434	7.38	11/14/08	BA1	2.71	5.26%
	LYONDELL CHEMICAL CO	47,882	9.63	5/01/07	B1	1.41	6.26%

VERMONT MUNICIPAL EMPLOYEES

BOND HOLDINGS

AS OF 9/05

SEIX HIGH YIELD

<u>BOND NAME</u>	<u>MARKET VALUE</u>	<u>COUPON</u>	<u>STATED MATURITY</u>	<u>MOODY RATE</u>	<u>DUR- ATION</u>	<u>YIELD TO MATURITY</u>
MANDALAY RESORT GRP	123,185	10.25	8/01/07	BA3	1.65	5.87%
MCI INC	22,625	7.69	5/01/09	B2	1.27	5.91%
MCI INC	61,961	6.91	5/01/07	B2	0.63	5.58%
MGM MIRAGE INC	185,334	8.50	9/15/10	BA2	4.04	6.41%
MGM MIRAGE INC	77,583	9.75	6/01/07	BA3	1.50	5.61%
MIDWEST_GEN_2000- A	36,746	8.30	7/02/09	B1	2.28	6.18%
MILLENNIUM AMER INC	82,218	7.00	11/15/06	B1	1.05	4.58%
MILLENNIUM AMER INC	52,272	9.25	6/15/08	B1	2.34	6.19%
MSW ENERGY HLDGS	49,918	8.50	9/01/10	BA3	2.61	6.38%
MSW ENERGY HLDGS	68,809	7.38	9/01/10	BA3	3.21	6.28%
NMHG HLDG CO	30,049	10.00	5/15/09	B3	0.95	6.34%
OWENS BROCKWAY GLASS	42,940	8.88	2/15/09	B1	1.26	6.56%
PACIFICARE HEALTH SYS INC	48,413	10.75	6/01/09	BA3	0.64	5.96%
PARK PLACE ENT	89,479	7.50	9/01/09	BAA3	3.38	5.20%
PARK PLACE ENT	20,469	9.38	2/15/07	BA1	1.28	5.17%
PENN NATL GAMING INC	22,345	8.88	3/15/10	B2	0.98	6.19%
PETROLEUM HELICOPTERS INC	27,060	9.38	5/01/09	B1	1.12	6.30%
PREMCO REFNG GROUP	76,231	9.25	2/01/10	BAA3	1.26	5.72%
PRIMEDIA INC	11,219	7.63	4/01/08	B2	0.47	5.58%
PSEG ENERGY HLDGS	10,634	10.00	10/01/09	BA3	3.18	6.81%
PSEG ENERGY HLDGS	127,552	8.63	2/15/08	BA3	2.11	6.54%
RELIANT RES INC	32,342	9.25	7/15/10	B1	2.25	6.60%
ROUSE CO	41,859	8.00	4/30/09	BA1	3.02	5.67%
SALTON SEA FDG CORP	15,750	7.84	5/30/10	BA1	2.28	5.80%
SEAGATE TECHNOLOGY HDD HL	40,458	8.00	5/15/09	BA2	1.46	5.91%
SITHE / INDEPENDENCE FDG C	15,160	8.50	6/30/07	BA2	0.95	6.68%
SMITHFIELD FOODS INC	44,132	8.00	10/15/09	BA2	3.32	6.36%
SOUTHERN NATURAL GAS	20,311	6.13	9/15/08	B1	2.66	6.28%

VERMONT MUNICIPAL EMPLOYEES

BOND HOLDINGS

AS OF 9/05

SEIX HIGH YIELD

	<u>BOND NAME</u>	<u>MARKET VALUE</u>	<u>COUPON</u>	<u>STATED MATURITY</u>	<u>MOODY RATE</u>	<u>DUR-ATION</u>	<u>YIELD TO MATURITY</u>
	SWIFT & CO	29,493	10.13	10/01/09	B1	1.47	7.07%
	SWIFT & CO	10,944	12.50	1/01/10	B2	1.54	8.95%
	TRANSMONTAIGNE OIL CO	16,067	9.13	6/01/10	B3	2.83	7.53%
	TXU CORP	33,659	4.80	11/15/09	BA1	3.61	5.81%
	XEROX CORP	165,511	9.75	1/15/09	BA2	2.79	5.69%
	XEROX CORP	15,852	7.13	6/15/10	BA2	3.91	5.83%
		<u>2,894,487</u>	<u>8.62</u>			<u>2.30</u>	<u>6.00%</u>
5-10 YEARS	3815668 CANADA INC	147,317	8.00	9/15/12	B2	4.83	6.73%
	AES CORP 144A	124,744	8.75	5/15/13	BA3	2.77	6.32%
	AINSWORTH LMBR LTD	13,772	6.75	3/15/14	B2	6.00	8.34%
	AINSWORTH LMBR LTD	20,253	7.25	10/01/12	B2	5.06	8.40%
	ALLEGHENY ENERGY SUPPLY	118,196	8.25	4/15/12	BA3	4.96	5.92%
	ALLEGHENY ENERGY SUPPLY	16,893	7.80	3/15/11	BA3	4.45	5.75%
	AMERIGAS PARTNERS LP 144A	37,489	7.25	5/20/15	B2	5.49	6.49%
	APPLETON PAPERS INC	34,450	8.13	6/15/11	B2	4.16	8.57%
	APPLETON PAPERS INC	15,302	9.75	6/15/14	B3	5.32	10.46%
	AQUILA INC	51,182	11.88	7/01/12	B2	4.90	5.36%
	ARGOSY GAMING CO	92,108	9.00	9/01/11	BA3	0.88	4.31%
	AZTAR CORP	15,669	9.00	8/15/11	BA3	1.44	6.60%
	BALL CORP	4,801	6.88	12/15/12	BA2	4.22	6.41%
	BCP CRYSTAL US HLDGS	36,769	9.63	6/15/14	B3	3.69	7.26%
	BEAR CREEK CORP 144A	16,400	9.00	3/01/13	B3	4.43	8.19%
	BERRY PLASTICS	22,937	10.75	7/15/12	B3	2.67	8.78%
	BOYD GAMING CORP	42,994	8.75	4/15/12	B1	1.77	6.15%
	BOYD GAMING CORP	1,102	6.75	4/15/14	B1	5.37	6.68%
	CABLEVISION SYS CORP	49,002	8.00	4/15/12	B3	4.80	8.61%
	CARROLS CORP 144A	17,676	9.00	1/15/13	B3	4.51	8.63%

VERMONT MUNICIPAL EMPLOYEES

BOND HOLDINGS

AS OF 9/05

SEIX HIGH YIELD

<u>BOND NAME</u>	<u>MARKET VALUE</u>	<u>COUPON</u>	<u>STATED MATURITY</u>	<u>MOODY RATE</u>	<u>DUR-ATION</u>	<u>YIELD TO MATURITY</u>
CASELLA WASTE SYSTEMS	22,874	9.75	2/01/13	B3	2.99	7.84%
CB RICHARD ELLIS SVCS INC	37,223	11.25	6/15/11	B1	0.66	5.95%
CHC HELICOPTER CORP 144A	24,658	7.38	5/01/14	B2	5.05	6.89%
CHC HELICOPTER CORP	17,228	7.38	5/01/14	B2	5.05	6.89%
CHESAPEAKE ENERGY CORP	30,855	7.75	1/15/15	BA2	3.23	6.25%
CHESAPEAKE ENERGY CORP	82,444	7.50	6/15/14	BA2	4.43	6.25%
CHESAPEAKE ENERGY CORP	130,683	7.50	9/15/13	BA2	3.84	6.18%
CITIZENS COMM	137,862	9.25	5/15/11	BA3	4.28	7.11%
CITIZENS COMM	31,729	6.25	1/15/13	BA3	5.66	6.96%
CO INTERSTATE GAS 144A	16,181	5.95	3/15/15	B1	7.08	6.38%
COMCAST CORP NEW	36,325	6.50	1/15/15	BAA2	6.94	5.39%
CORRECTIONS CORP AMER	83,430	7.50	5/01/11	BA3	3.10	6.51%
COUCHE TARD US LP	6,787	7.50	12/15/13	BA3	4.75	6.89%
COVENTRY HEALTH CARE	11,954	6.13	1/15/15	BA1	6.97	5.77%
COVENTRY HEALTH CARE	61,879	8.13	2/15/12	BA1	1.36	4.92%
COVENTRY HEALTH CARE	15,181	5.88	1/15/12	BA1	5.15	5.59%
CROWN EUROPEAN HLDGS	40,171	10.88	3/01/13	B2	2.14	5.81%
CRUM & FOSTER HLDGS CORP	30,783	10.38	6/15/13	BA3	5.22	8.70%
DAVITA INC	47,496	6.63	3/15/13	B2	4.96	6.35%
DAVITA INC	45,752	7.25	3/15/15	B3	5.90	7.01%
DEL MONTE CORPORATION	21,104	8.63	12/15/12	B2	2.80	6.75%
DEX MEDIA INC	14,249	0.00	11/15/13	B3	5.64	8.35%
DEX MEDIA WEST LLC	71,575	9.88	8/15/13	B2	3.05	7.37%
DIRECTV HLDGS	196,885	8.38	3/15/13	BA2	2.67	5.94%
DYNEGY INC	46,578	10.13	7/15/13	B3	2.74	7.17%
EDISON MISSION ENERGY	101,942	9.88	4/15/11	B1	4.21	5.91%
ELIZABETH ARDEN INC	36,716	7.75	1/15/14	B2	5.05	7.40%
ENCORE ACQUISITION 144A	50,224	6.00	7/15/15	B2	6.61	6.34%

VERMONT MUNICIPAL EMPLOYEES

BOND HOLDINGS

AS OF 9/05

SEIX HIGH YIELD

<u>BOND NAME</u>	<u>MARKET VALUE</u>	<u>COUPON</u>	<u>STATED MATURITY</u>	<u>MOODY RATE</u>	<u>DUR-ATION</u>	<u>YIELD TO MATURITY</u>
ENTERPRISE PRODUCTS	18,917	5.60	10/15/14	BAA3	6.87	5.65%
EQUISTAR CHEMICALS	11,401	10.63	5/01/11	B2	2.06	7.66%
EXCO RESOURCES	31,209	7.25	1/15/11	B2	2.70	6.06%
FAIRFAX FINL HLDGS	1,657	7.75	4/26/12	BA3	4.86	8.56%
FERRELLGAS LP	6,802	6.75	5/01/14	BA3	5.86	7.47%
FERRELLGAS PARTNERS L P/F	43,568	8.75	6/15/12	B2	3.96	8.35%
FIRSTENERGY CORP	34,245	6.45	11/15/11	BAA3	4.95	5.20%
FISHER SCIENTIFIC 144A	32,033	6.13	7/01/15	BA3	6.31	6.08%
FOREST OIL CORP	45,224	8.00	12/15/11	BA3	4.83	5.95%
FREESCALE SEMICONDUCTOR	9,635	7.13	7/15/14	BA2	4.58	5.94%
GAYLORD ENTERTAINMENT	16,803	8.00	11/15/13	B3	5.81	7.17%
GENERAL CABLE CORP	48,525	9.50	11/15/10	B2	3.91	8.22%
GEO GROUP INC	21,750	8.25	7/15/13	B1	4.95	8.33%
GEORGIA PACIFIC	48,275	8.13	5/15/11	BA2	4.43	5.90%
GEORGIA PACIFIC	26,844	9.50	12/01/11	BA2	4.67	5.97%
GEORGIA PACIFIC	7,289	9.38	2/01/13	BA1	2.17	5.92%
GOLD KIST INC	27,479	10.25	3/15/14	B2	5.76	8.10%
GRAY TELEVISION INC	39,174	9.25	12/15/11	BA3	1.18	5.82%
HANOVER COMPRESSOR	20,107	9.00	6/01/14	B3	3.63	6.63%
HANOVER COMPRESSOR	20,229	8.63	12/15/10	B3	2.80	6.49%
HANOVER EQUIP TR 2001A	39,684	8.75	9/01/11	B2	1.42	6.33%
HCA INC	58,877	7.88	2/01/11	BA2	4.31	6.27%
HCA INC	10,396	6.30	10/01/12	BA2	5.42	6.41%
HOST MARRIOTT L P	2,243	7.13	11/01/13	BA3	4.79	6.69%
HOUGHTON MIFFLIN CO	47,246	8.25	2/01/11	B3	2.92	7.13%
HUNTSMAN LLC	71,519	11.63	10/15/10	BA3	1.79	6.74%
HUNTSMAN LLC	14,698	11.50	7/15/12	B2	2.68	7.61%
INERGY LTD PARTNERS 144A	35,509	6.88	12/15/14	B1	6.20	7.56%

VERMONT MUNICIPAL EMPLOYEES

BOND HOLDINGS

AS OF 9/05

SEIX HIGH YIELD

<u>BOND NAME</u>	<u>MARKET VALUE</u>	<u>COUPON</u>	<u>STATED MATURITY</u>	<u>MOODY RATE</u>	<u>DUR-ATION</u>	<u>YIELD TO MATURITY</u>
INMARSAT FIN PLC	50,989	7.63	6/30/12	B1	4.11	6.95%
INTELSAT LTD 144A	133,241	8.25	1/15/13	B2	4.67	8.10%
ISLE CAPRI CASINOS INC	29,990	9.00	3/15/12	B2	2.55	7.39%
JOSTENS INC	11,567	7.63	10/01/12	B3	4.43	7.38%
KABEL DEUTSCHLAND GMBH 14	51,719	10.63	7/01/14	B2	3.86	8.34%
KERR MCGEE CORP	70,606	6.88	9/15/11	BA3	4.88	5.50%
KINETIC CONCEPTS	24,250	7.38	5/15/13	B2	4.29	6.72%
KOPPERS INC	37,284	9.88	10/15/13	B2	5.41	8.07%
L-3 COMMUNICATIONS CORP	81,630	7.63	6/15/12	BA3	2.92	6.38%
LEUCADIA NATL 144A	41,678	7.00	8/15/13	BA2	5.94	6.92%
LIN TELEVISION CORP 144A	22,843	6.50	5/15/13	B1	5.86	7.42%
LUSCAR COAL LTD	42,156	9.75	10/15/11	BA3	1.02	6.29%
LYONDELL CHEM WW	51,022	10.25	11/01/10	B1	3.83	7.94%
MARKWEST ENERGY PART 144A	19,104	6.88	11/01/14	B1	5.84	7.02%
MCI INC	221,671	8.73	5/01/14	B2	3.21	5.98%
NALCO CO	92,080	7.75	11/15/11	B2	3.69	7.11%
NELL AF SARL 144A	49,688	8.38	8/15/15	B2	6.13	8.72%
NEXTEL COMM INC	99,667	7.38	8/01/15	BAA2	3.10	5.73%
NEXTEL COMM INC	63,491	5.95	3/15/14	BAA2	4.99	5.51%
NEXTEL COMM INC	116,626	6.88	10/31/13	BAA2	3.59	5.55%
NTL CABLE PLC	67,376	8.75	4/15/14	B3	4.79	8.10%
OMEGA HEALTHCARE	23,980	7.00	4/01/14	B1	6.13	6.84%
OWENS BROCKWAY GLASS	72,068	8.75	11/15/12	B1	2.53	6.60%
PANAMSAT CORP NEW	27,090	9.00	8/15/14	B1	4.81	7.94%
PARK PLACE ENT	22,319	8.13	5/15/11	BA1	4.43	5.73%
PILGRIMS PRIDE CORP	20,126	9.63	9/15/11	BA2	1.04	6.38%
PLASTIPAK HLDGS INC	27,042	10.75	9/01/11	B3	0.87	6.28%
PQ CORP 144A	19,733	7.50	2/15/13	B3	5.13	8.04%

VERMONT MUNICIPAL EMPLOYEES

BOND HOLDINGS

AS OF 9/05

SEIX HIGH YIELD

<u>BOND NAME</u>	<u>MARKET VALUE</u>	<u>COUPON</u>	<u>STATED MATURITY</u>	<u>MOODY RATE</u>	<u>DUR-ATION</u>	<u>YIELD TO MATURITY</u>
PREMCOR REFNG GROUP	55,695	6.75	5/01/14	BAA3	4.12	5.55%
PREMCOR REFNG GROUP	28,319	6.13	5/01/11	BAA3	4.60	5.19%
PREMCOR REFNG GROUP	34,436	6.75	2/01/11	BAA3	4.44	5.23%
PRIMEDIA INC	23,095	8.88	5/15/11	B2	1.96	7.35%
PRIMEDIA INC	54,480	8.00	5/15/13	B2	5.48	7.86%
QUEBECOR MEDIA INC	43,593	11.13	7/15/11	B2	0.74	5.93%
QUICKSILVER INC 144A	15,162	6.88	4/15/15	B1	6.38	7.47%
QWEST COMM INTL	21,897	7.25	2/15/11	B3	4.13	7.85%
QWEST COMM INTL	11,029	7.50	2/15/14	B3	6.00	8.34%
QWEST COMM INTL 144A	57,630	7.50	2/15/14	B3	5.74	8.34%
QWEST CORP	32,633	7.17	6/15/13	BA3	0.39	6.62%
QWEST CORP	9,884	8.88	3/15/12	BA3	4.93	7.06%
QWEST CORP	100,205	7.88	9/01/11	BA3	4.68	6.98%
QWEST CORP 144A	30,976	7.63	6/15/15	BA3	6.67	7.31%
R H DONNELLEY CORP	10,778	10.88	12/15/12	B2	2.00	7.09%
R H DONNELLEY CORP	100,804	10.88	12/15/12	B2	2.00	7.09%
RADIO ONE INC	30,283	8.88	7/01/11	B2	1.07	6.08%
RAINBOW NATL SVCS 144A	76,258	8.75	9/01/12	B3	3.75	7.13%
RANGE RES CORP	18,293	7.38	7/15/13	B3	3.75	6.13%
READERS DIGEST ASSN	65,565	6.50	3/01/11	BA2	3.93	6.11%
REFCO FIN HLDGS LLC	17,539	9.00	8/01/12	B3	3.35	6.84%
RELIANT RES INC	19,012	9.50	7/15/13	B1	2.87	6.87%
ROCKWOOD SPECIALTIES	29,972	10.63	5/15/11	B3	1.86	7.74%
ROCKWOOD SPECIALTIES 144A	44,183	7.50	11/15/14	B3	5.90	7.97%
ROGERS CABLE INC	2,746	6.25	6/15/13	BA3	5.90	6.71%
ROGERS WIRELESS	64,803	6.38	3/01/14	BA3	6.41	6.30%
ROGERS WIRELESS	6,762	7.50	3/15/15	BA3	6.80	6.39%
ROUSE CO	27,330	7.20	9/15/12	BA1	5.45	6.20%

VERMONT MUNICIPAL EMPLOYEES

BOND HOLDINGS

AS OF 9/05

SEIX HIGH YIELD

	<u>BOND NAME</u>	<u>MARKET VALUE</u>	<u>COUPON</u>	<u>STATED MATURITY</u>	<u>MOODY RATE</u>	<u>DUR-ATION</u>	<u>YIELD TO MATURITY</u>
	SENECA GAMING CORP 144A	16,831	7.25	5/01/12	B1	5.07	6.77%
	SIERRA PAC RESOURCES	23,277	7.80	6/15/12	B1	4.26	6.42%
	SITHE / INDEPENDENCE FDG C	71,890	9.00	12/30/13	BA2	4.31	6.98%
	SMITHFIELD FOODS INC	38,108	7.75	5/15/13	BA2	5.59	6.89%
	SUBURBAN PROPANE PART	52,301	6.88	12/15/13	B1	5.83	8.41%
	SUNGARD DATA SYS 144A	13,819	9.13	8/15/13	B3	4.72	8.33%
	SYBRON DENTAL SPECIALTIES	29,008	8.13	6/15/12	B1	2.21	6.04%
	TECO ENERGY INC 144A	7,669	6.75	5/01/15	BA2	6.91	6.09%
	TEXAS GENCO LLC 144A	112,435	6.88	12/15/14	B1	5.65	6.56%
	TRANSCONTINENTAL GAS PIPE	12,381	8.88	7/15/12	BA2	5.14	5.87%
	TRIAD HOSPS INC	51,585	7.00	5/15/12	B2	4.03	6.30%
	TXU CORP	118,803	5.55	11/15/14	BA1	6.86	6.29%
	US CONCRETE	22,442	8.38	4/01/14	B3	5.77	8.29%
	UTILICORP UNITED	23,540	9.95	2/01/11	B2	4.13	7.14%
	VENTAS RLTY LP 144A	16,942	7.13	6/01/15	BA3	5.69	6.54%
	WARNER MUSIC GROUP	69,329	7.38	4/15/14	B3	5.30	7.32%
	WILLIAMS COS	166,477	7.13	9/01/11	B1	4.79	6.15%
	WILLIAMS COS	71,074	8.13	3/15/12	B1	5.04	6.35%
	XEROX CORP	37,326	6.88	8/15/11	BA2	4.78	5.95%
		<u>6,700,802</u>	<u>8.16</u>			<u>4.09</u>	<u>6.67%</u>
10-20 YEARS	AES RED OAK L L C *	29,259	8.54	11/30/19	B2	7.75	7.14%
	CHESAPEAKE ENERGY CORP 144	92,109	6.50	8/15/17	BA2	8.16	6.29%
	CROWN CORK & SEAL CO	8,026	8.00	4/15/23	B3	5.87	8.17%
	FAIRFAX FINL HLDGS	9	7.38	4/15/18	BA3	7.39	9.21%
	FPL ENERGY NAT WIN 144A	24,129	6.13	3/25/19	BA2	9.04	6.27%
	FPL ENERGY WIND FDG 144A	33,418	6.88	6/27/17	BA2	8.02	6.69%
	HOMER CITY FDG LLC	30,918	8.14	10/01/19	BA2	5.54	5.94%

VERMONT MUNICIPAL EMPLOYEES

BOND HOLDINGS

AS OF 9/05

SEIX HIGH YIELD

	<u>BOND NAME</u>	<u>MARKET VALUE</u>	<u>COUPON</u>	<u>STATED MATURITY</u>	<u>MOODY RATE</u>	<u>DUR-ATION</u>	<u>YIELD TO MATURITY</u>
	KERR MCGEE CORP	40,479	6.95	7/01/24	BA3	10.34	6.61%
	MIDWEST_GEN_2000- B	118,496	8.56	1/02/16	B1	4.78	6.54%
	SALTON SEA FDG CORP	14,148	7.47	11/30/18	BA1	6.49	6.17%
	TENASKA ALA PARTNER 144A	48,551	7.00	6/30/21	B1	9.36	6.93%
	TENNESSEE GAS PIPELINE	7,270	7.50	4/01/17	B1	7.53	6.53%
		446,811	7.47			7.32	6.55%
OVER 20 YEARS	AES RED OAK L L C *	26,232	9.20	11/30/29	B2	9.93	7.94%
	AFC CAP TR I	43,203	8.21	2/03/27	BA2	10.27	7.42%
	ALLMERICA FINL CORP	17,238	7.65	10/15/25	BA1	10.11	6.99%
	AT&T CORP	200,845	9.75	11/15/31	BA1	10.59	7.43%
	COLUMBIA/HCA HEALTHCARE	57,621	7.50	11/15/95	BA2	11.87	8.17%
	EL PASO NAT GAS	44,669	8.38	6/15/32	B1	11.17	7.22%
	FAIRFAX FINL HLDGS	6,860	7.75	7/15/37	BA3	9.66	9.87%
	FIRSTENERGY CORP	21,468	7.38	11/15/31	BAA3	12.48	6.05%
	GEORGIA PACIFIC	3,884	8.88	5/15/31	BA2	10.78	7.29%
	HCA INC	6,626	7.50	11/06/33	BA2	11.24	7.52%
	HOMER CITY FUND	44,852	8.73	10/01/26	BA2	10.03	7.00%
	LEUCADIA NATL	1,468	8.65	1/15/27	BA3	4.30	8.09%
	LUCENT TECHNOLOGIES	38,072	6.45	3/15/29	B1	11.13	7.60%
	MARKEL CAP TR I	44,766	8.71	1/01/46	BA1	2.38	6.73%
	MARKEL CORP	19,193	7.35	8/15/34	BAA3	12.82	6.77%
	MIDWEST GENERATION LLC /	7,991	8.75	5/01/34	B1	3.48	6.26%
	ROGERS CABLE INC	46,962	8.75	5/01/32	BA3	10.75	7.50%
	SOUTHERN NATURAL GAS	34,472	8.00	3/01/32	B1	11.47	7.12%
	TENNESSEE GAS PIPELINE	17,684	8.38	6/15/32	B1	11.21	7.17%
	US WEST COMM	711	7.20	11/10/26	BA3	8.87	8.26%
	WILLIAMS COS	122,295	8.75	3/15/32	B1	11.26	7.22%

VERMONT MUNICIPAL EMPLOYEES

BOND HOLDINGS

AS OF 9/05

SEIX HIGH YIELD

<u>BOND NAME</u>	<u>MARKET VALUE</u>	<u>COUPON</u>	<u>STATED MATURITY</u>	<u>MOODY RATE</u>	<u>DUR- ATION</u>	<u>YIELD TO MATURITY</u>
WILLIAMS COS	6,623	7.75	6/15/31	B1	11.30	7.05%
XEROX CAP TRUST I	15,735	8.00	2/01/27	BA3	3.15	6.79%
	<u>829,470</u>	<u>8.59</u>			<u>10.25</u>	<u>7.32%</u>

VERMONT MUNICIPAL EMPLOYEES

TOTAL PUBLIC FUNDS - EQUITY COMMITMENT

ASSET ALLOCATION HISTORY

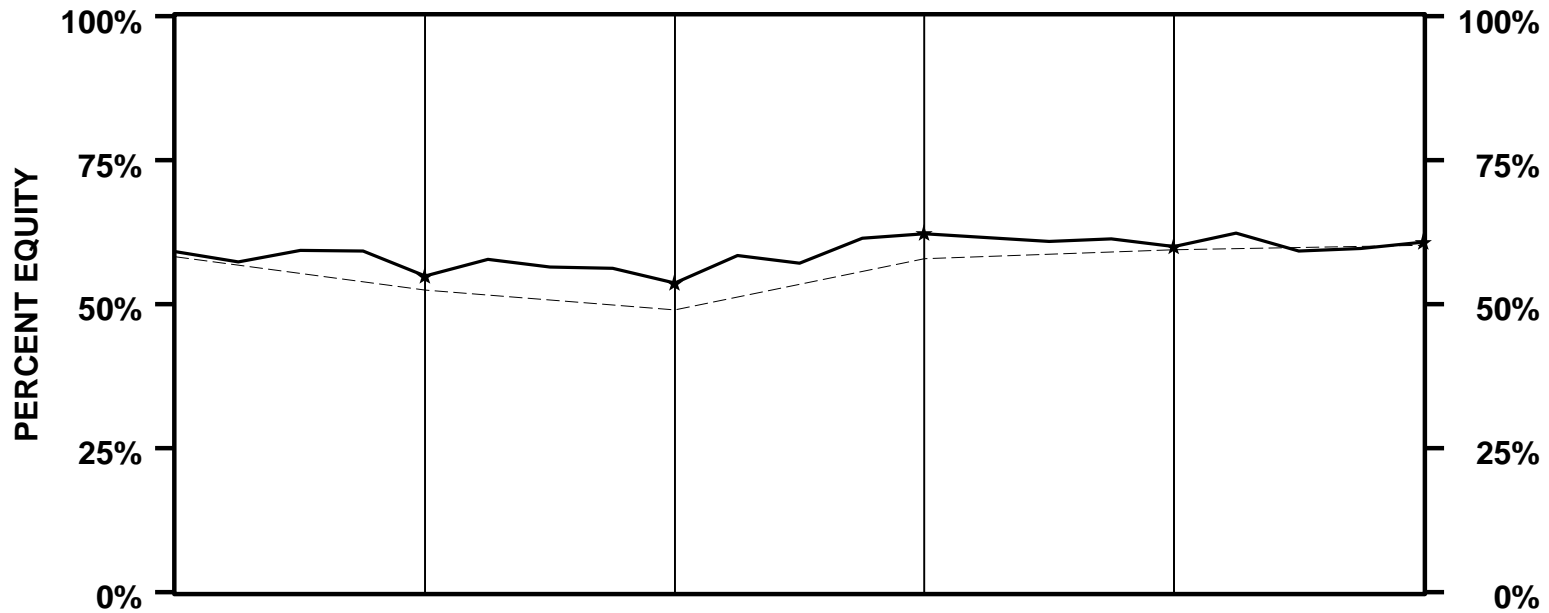

	9/00		9/01		9/02		9/03		9/04		9/05	
HIGH	71.4		66.5		63.8		70.4		71.8		75.2	
1ST QTL	62.7		56.3		55.1		63.1		63.8		65.0	
■ MEDIAN	58.2		52.5		49.0		57.9		59.5		60.2	
3RD QTL	52.5		43.7		40.7		50.5		53.5		51.8	
LOW	0.0		0.0		0.0		0.0		9.5		0.0	
★ MUNI COMPOSITE	59.1	43	54.9	30	53.7	29	62.3	28	60.0	46	60.8	45

* Includes International Segment

VERMONT MUNICIPAL EMPLOYEES

TOTAL PUBLIC FUNDS - BOND COMMITMENT

ASSET ALLOCATION HISTORY

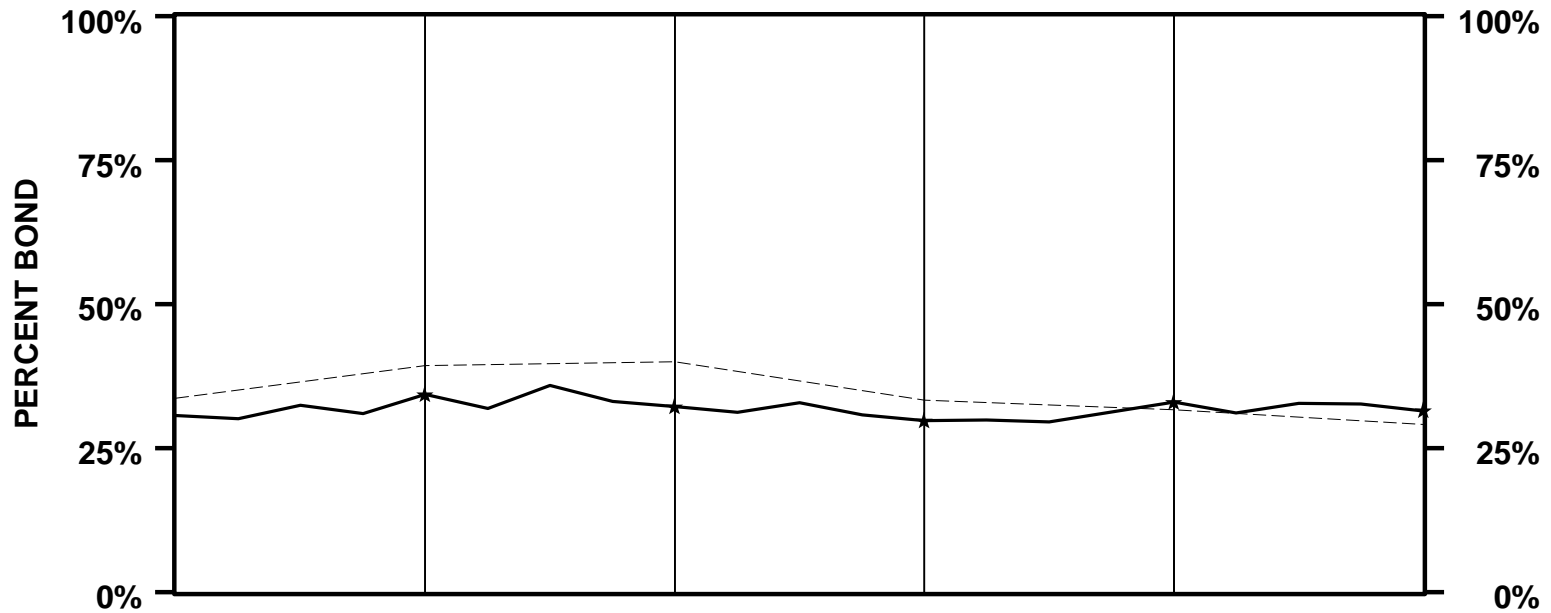

	9/00		9/01		9/02		9/03		9/04		9/05	
HIGH	60.4		66.0		66.5		60.0		56.4		54.6	
1ST QTL	39.9		44.7		47.9		40.3		37.4		37.5	
■ MEDIAN	33.7		39.3		40.0		33.3		31.7		29.1	
3RD QTL	26.6		29.8		31.1		28.0		26.7		24.5	
LOW	0.0		0.0		0.0		3.9		0.0		0.0	
★ MUNI COMPOSITE	30.7	63	34.3	62	32.2	72	29.8	67	33.0	45	31.5	43

* Includes International Segment

VERMONT MUNICIPAL EMPLOYEES

EQUITY LARGE FUNDS - EQUITY COMMITMENT

ASSET ALLOCATION HISTORY

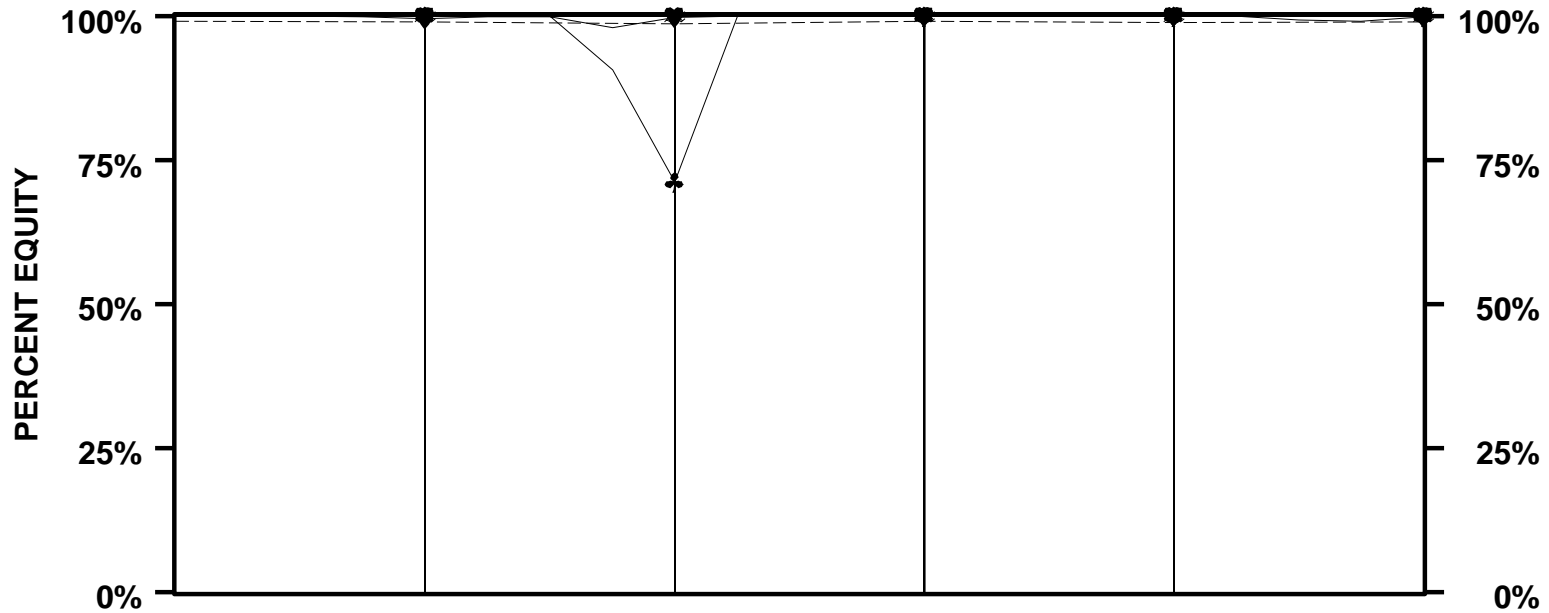

	9/00	9/01	9/02	9/03	9/04	9/05
HIGH	100.0	100.0	100.0	100.0	100.0	100.0
1ST QTL	100.0	100.0	100.0	100.0	100.0	100.0
MEDIAN	99.1	99.0	98.7	99.1	98.9	99.0
3RD QTL	96.7	96.3	96.5	96.5	96.9	97.0
LOW	92.4	92.4	87.5	61.6	70.5	92.5
♥ DELAWARE	100.0	99.6	99.8	100.0	100.0	99.9
♣ ALLIANCE	100.0	100.0	71.2	100.0	100.0	100.0
≡ LAZARD	100.0	100.0	100.0	100.0	100.0	100.0
♥ UBS	100.0	100.0	100.0	100.0	100.0	100.0

* Includes International Segment

VERMONT MUNICIPAL EMPLOYEES

EQUITY PUBLIC FUNDS - EQUITY COMMITMENT

ASSET ALLOCATION HISTORY

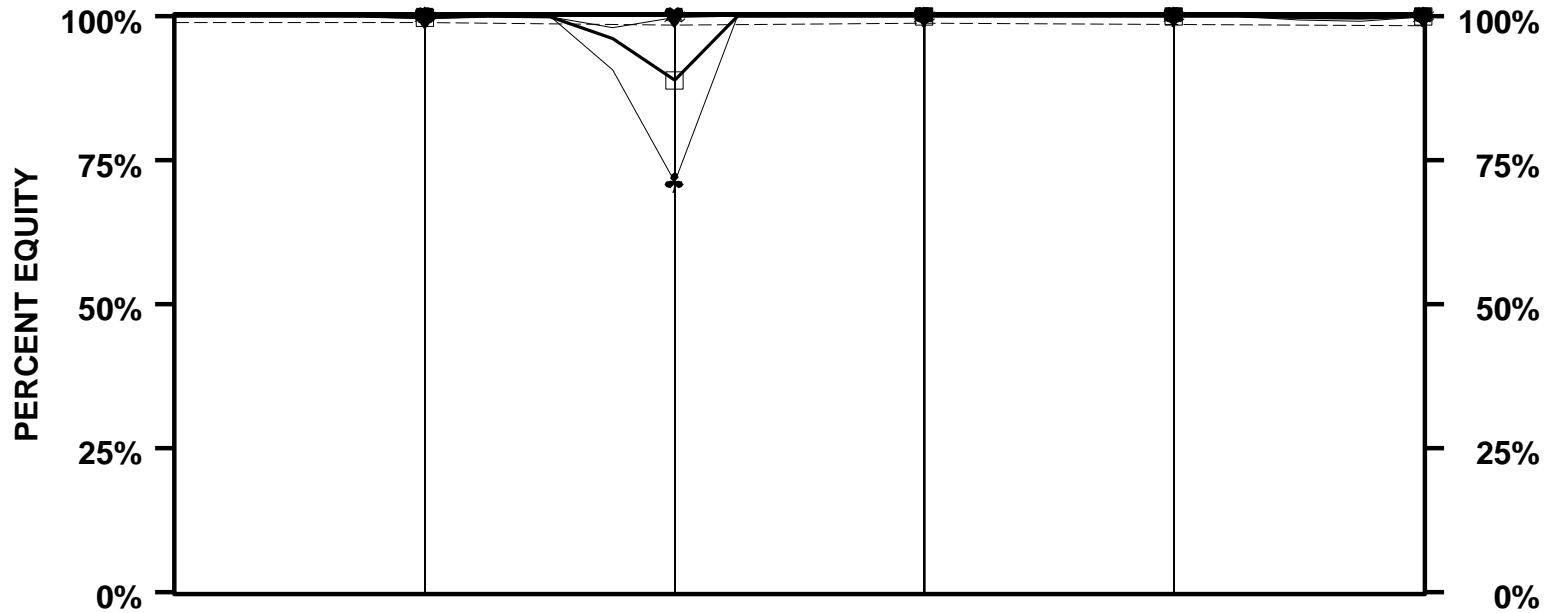

	9/00	9/01	9/02	9/03	9/04	9/05
HIGH	100.0	100.0	100.0	100.0	100.0	100.0
1ST QTL	100.0	100.0	100.0	100.0	100.0	99.9
■ MEDIAN	98.9	98.9	98.5	98.8	98.6	98.4
3RD QTL	96.1	95.9	95.7	96.5	96.3	96.2
LOW	1.0	77.5	0.2	50.0	0.0	0.0
□ EQTY COMPOSITE	100.0	99.8	88.9	100.0	100.0	100.0
♥ DELAWARE	100.0	99.6	99.8	100.0	100.0	99.9
♣ ALLIANCE	100.0	100.0	71.2	100.0	100.0	100.0
⌘ LAZARD	100.0	100.0	100.0	100.0	100.0	100.0
♥ UBS	100.0	100.0	100.0	100.0	100.0	100.0

* Includes International Segment

VERMONT MUNICIPAL EMPLOYEES

BOND LARGE FUNDS - BOND COMMITMENT

ASSET ALLOCATION HISTORY

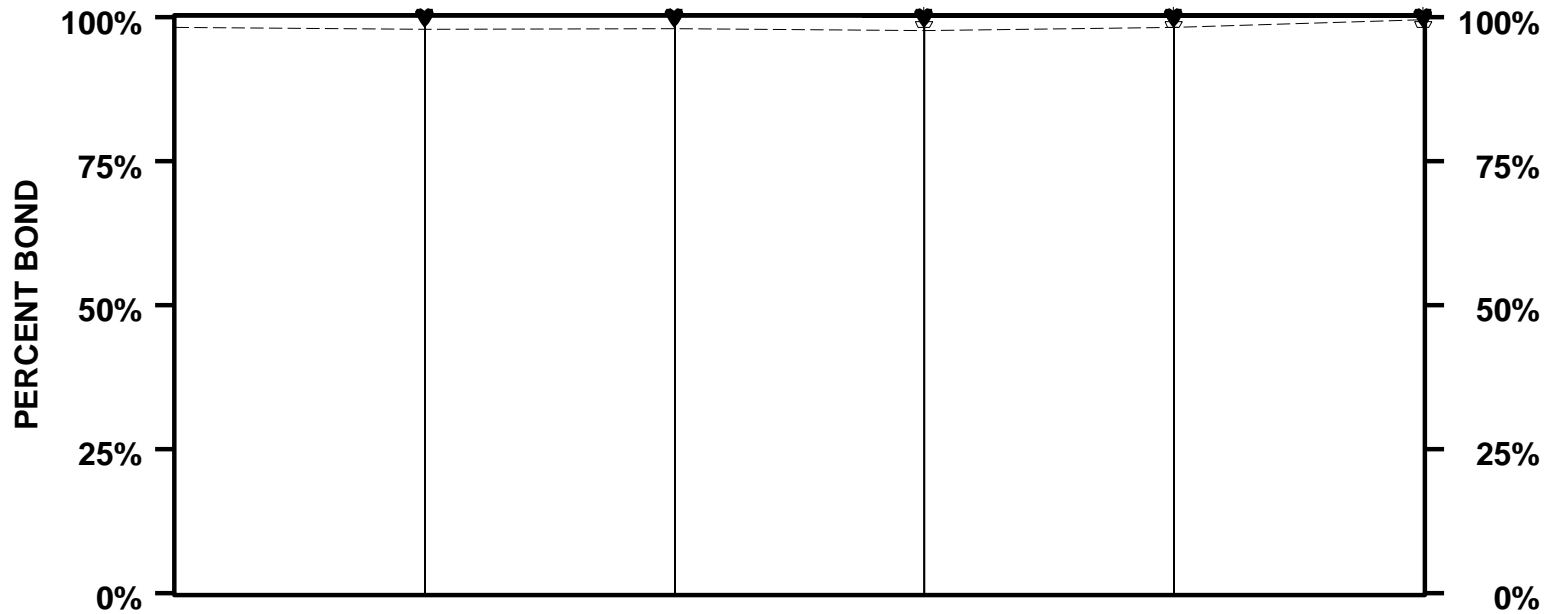

	9/00		9/01		9/02		9/03		9/04		9/05	
HIGH	100.0		100.0		100.0		100.0		100.0		100.0	
1ST QTL	100.0		100.0		100.0		100.0		100.0		100.0	
MEDIAN	98.3		97.9		98.0		97.7		98.3		99.6	
3RD QTL	92.9		91.5		93.0		93.6		94.1		95.6	
LOW	15.3		32.0		10.3		0.0		17.0		7.6	
♥ SEIX CORE	100.0	2	100.0	2	100.0	2	100.0	1	100.0	1	100.0	1
⚡ SEIX HIGH YIELD							100.0	1	100.0	1	100.0	1

* Includes International Segment

VERMONT MUNICIPAL EMPLOYEES

BOND PUBLIC FUNDS - BOND COMMITMENT

ASSET ALLOCATION HISTORY

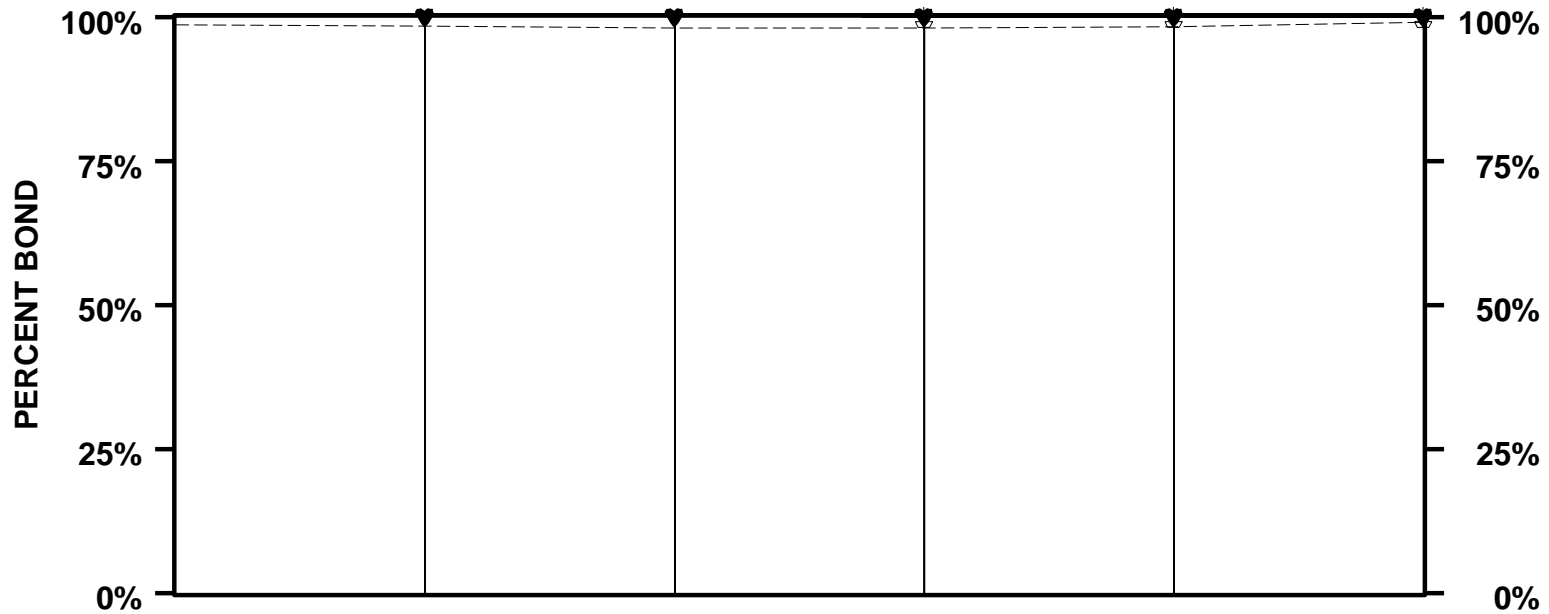

	9/00		9/01		9/02		9/03		9/04		9/05	
HIGH	100.0		100.0		100.0		100.0		100.0		100.0	
1ST QTL	100.0		100.0		100.0		100.0		100.0		100.0	
MEDIAN	98.7		98.5		98.1		98.2		98.4		99.1	
3RD QTL	95.0		93.9		93.8		94.1		94.8		95.7	
LOW	0.0		44.0		50.0		2.6		23.4		42.9	
♥ SEIX CORE	100.0	1	100.0	1	100.0	1	100.0	1	100.0	1	100.0	1
⚡ SEIX HIGH YIELD							100.0	1	100.0	1	100.0	1

* Includes International Segment

VERMONT MUNICIPAL EMPLOYEES

TOTAL PUBLIC FUNDS - TOTAL RATES OF RETURN

PERIODS ENDING 9/05

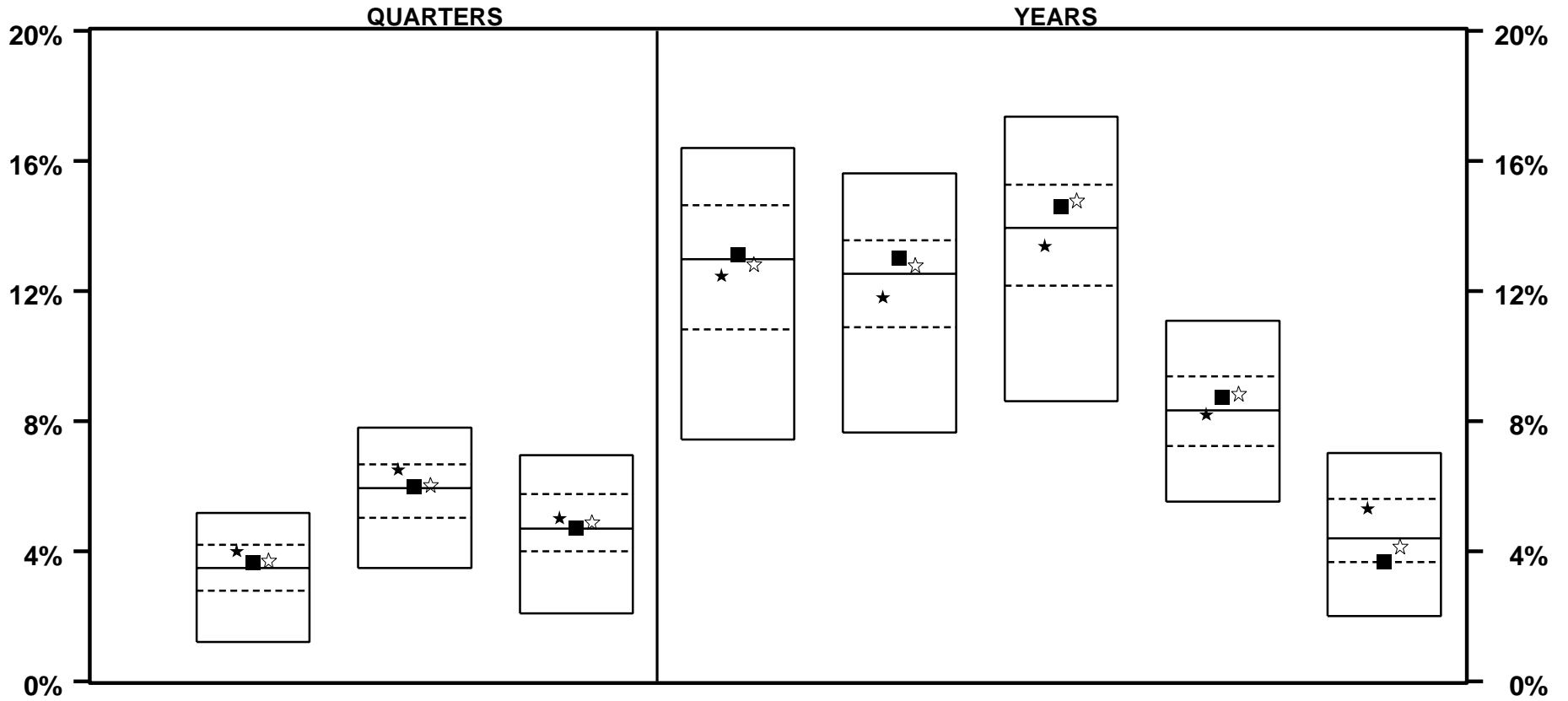

	LAST QTR		LAST 2 QTRS		LAST 3 QTRS		LAST YEAR		LAST 2 YEARS		LAST 3 YEARS		LAST 4 YEARS		LAST 5 YEARS	
★ MUNI COMPOSITE	4.0	36	6.5	31	5.0	41	12.5	55	11.8	60	13.4	63	8.2	54	5.3	31
■ ALLOC INDEX	3.6	46	6.0	47	4.7	49	13.1	48	13.0	36	14.6	39	8.7	38	3.7	74
☆ POLICY INDEX	3.7	43	6.0	42	4.9	44	12.8	51	12.8	39	14.8	34	8.9	36	4.2	57
MEDIAN	3.5		5.9		4.7		13.0		12.5		13.9		8.3		4.4	

VERMONT MUNICIPAL EMPLOYEES

TOTAL PUBLIC FUNDS - TOTAL RATES OF RETURN

PERIODS ENDING 9/05

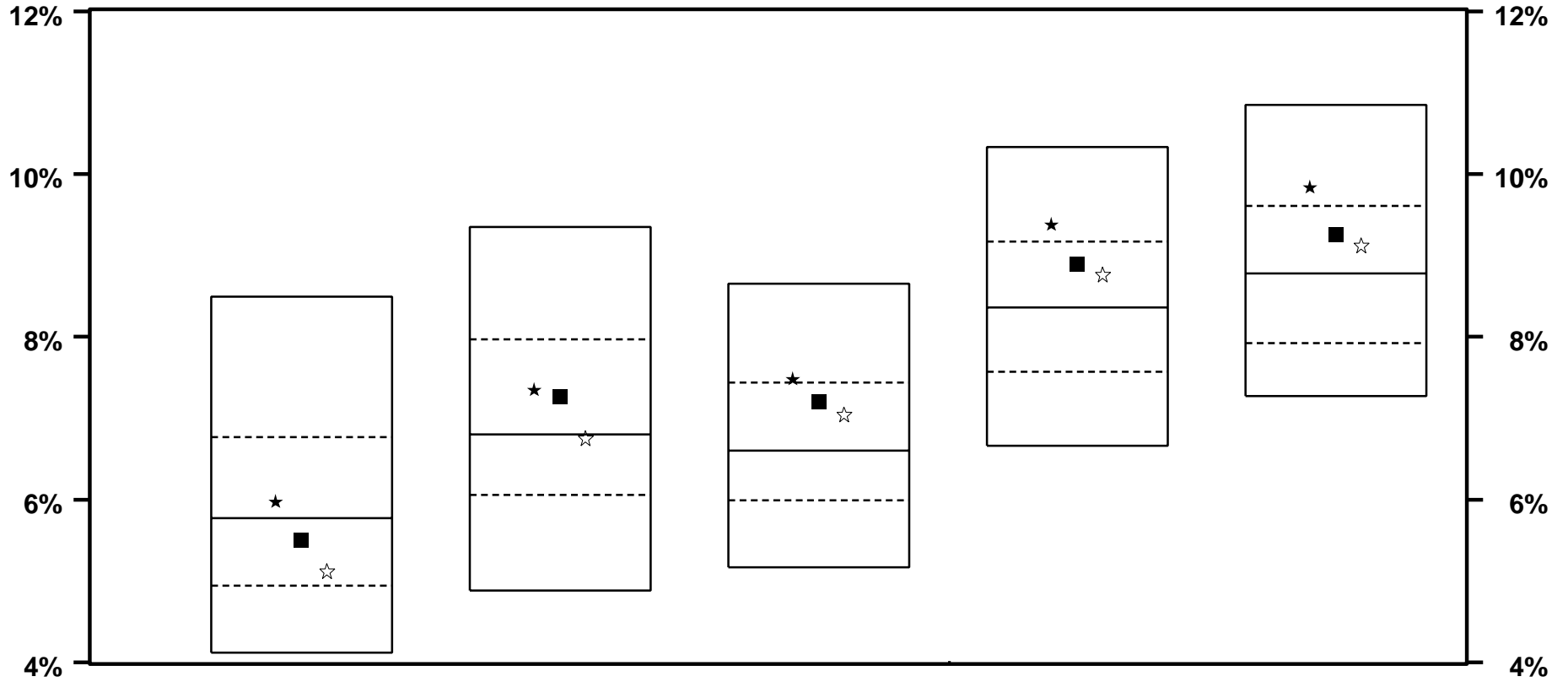

	LAST 6 YEARS		LAST 7 YEARS		LAST 8 YEARS		LAST 9 YEARS		LAST 10 YEARS	
★ MUNI COMPOSITE	6.0	43	7.4	37	7.5	22	9.4	19	9.8	16
■ ALLOC INDEX	5.5	58	7.3	40	7.2	31	8.9	31	9.3	36
☆ POLICY INDEX	5.1	71	6.8	53	7.1	36	8.8	38	9.1	40
MEDIAN	5.8		6.8		6.6		8.4		8.8	

VERMONT MUNICIPAL EMPLOYEES

TOTAL PUBLIC FUNDS - TOTAL RATES OF RETURN

YEARS ENDING

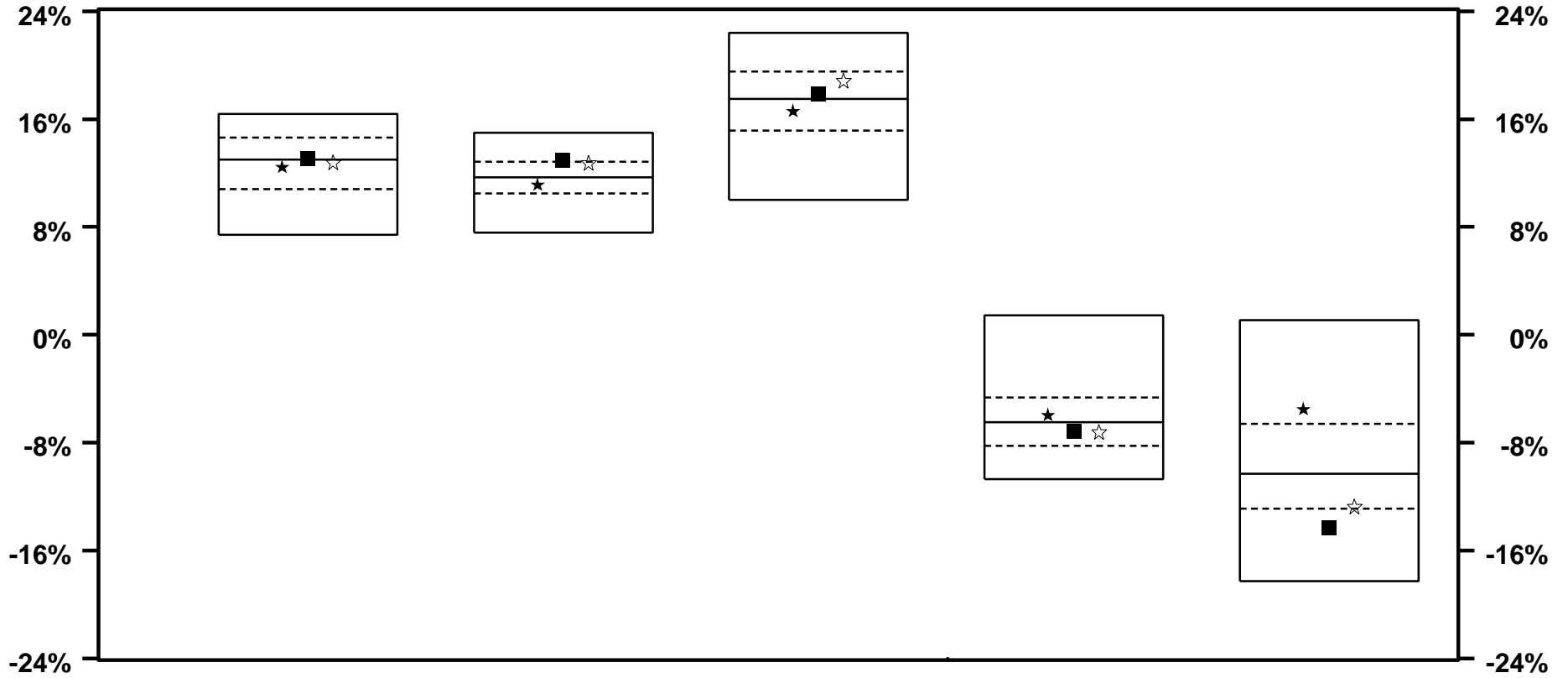

	9 / 05		9 / 04		9 / 03		9 / 02		9 / 01	
★ MUNI COMPOSITE	12.5	55	11.1	62	16.6	63	-5.9	40	-5.5	20
■ ALLOC INDEX	13.1	48	12.9	23	17.8	41	-7.1	60	-14.3	84
☆ POLICY INDEX	12.8	51	12.8	27	18.9	29	-7.2	61	-12.7	72
MEDIAN	13.0		11.7		17.5		-6.5		-10.3	

VERMONT MUNICIPAL EMPLOYEES

TOTAL PUBLIC FUNDS - TOTAL RATES OF RETURN

YEARS ENDING

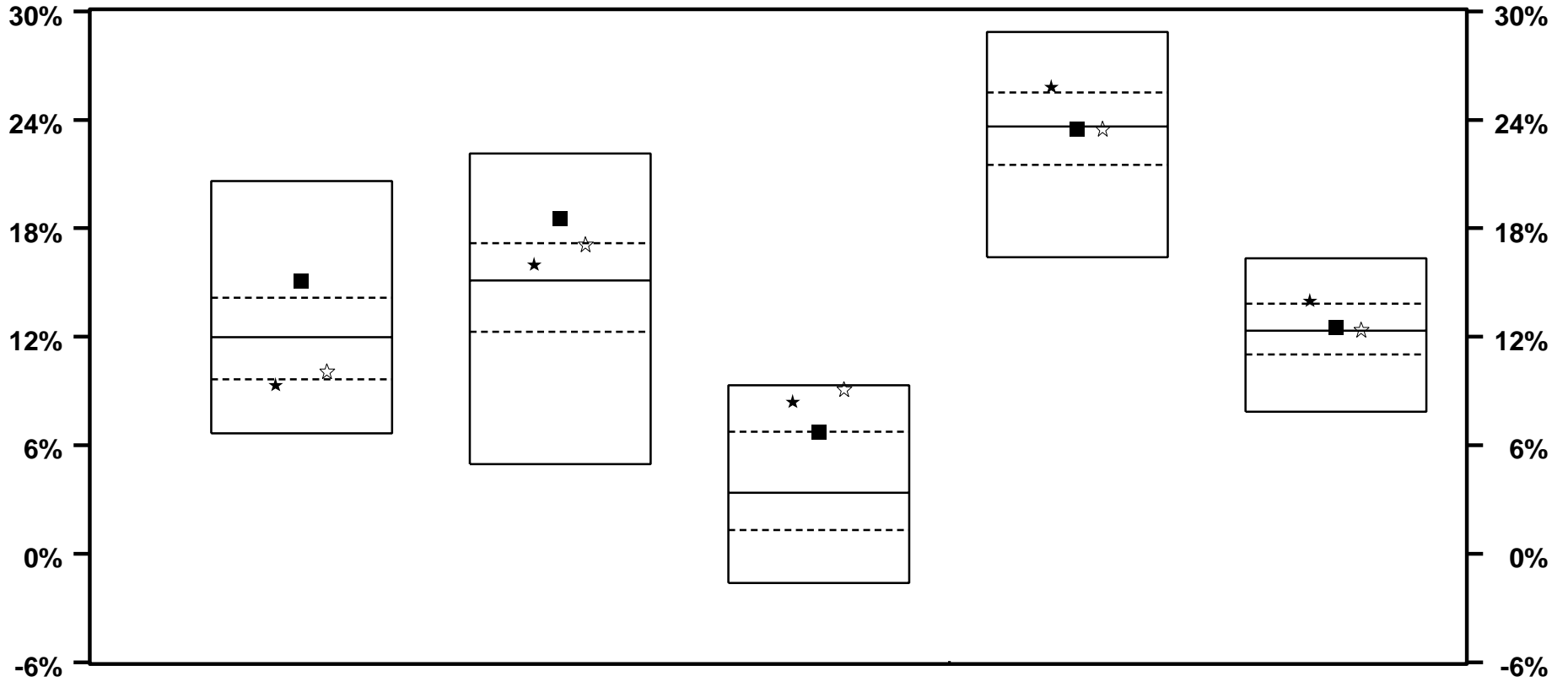

	9 / 00		9 / 99		9 / 98		9 / 97		9 / 96	
★ MUNI COMPOSITE	9.3	79	16.0	37	8.4	10	25.8	21	14.0	19
■ ALLOC INDEX	15.1	18	18.5	14	6.7	25	23.5	51	12.5	46
☆ POLICY INDEX	10.1	69	17.1	25	9.1	5	23.5	50	12.4	47
MEDIAN	12.0		15.1		3.4		23.6		12.3	

VERMONT MUNICIPAL EMPLOYEES

TOTAL PUBLIC FUNDS - TOTAL RETURN VS RISK

3 YEARS ENDING 9/05

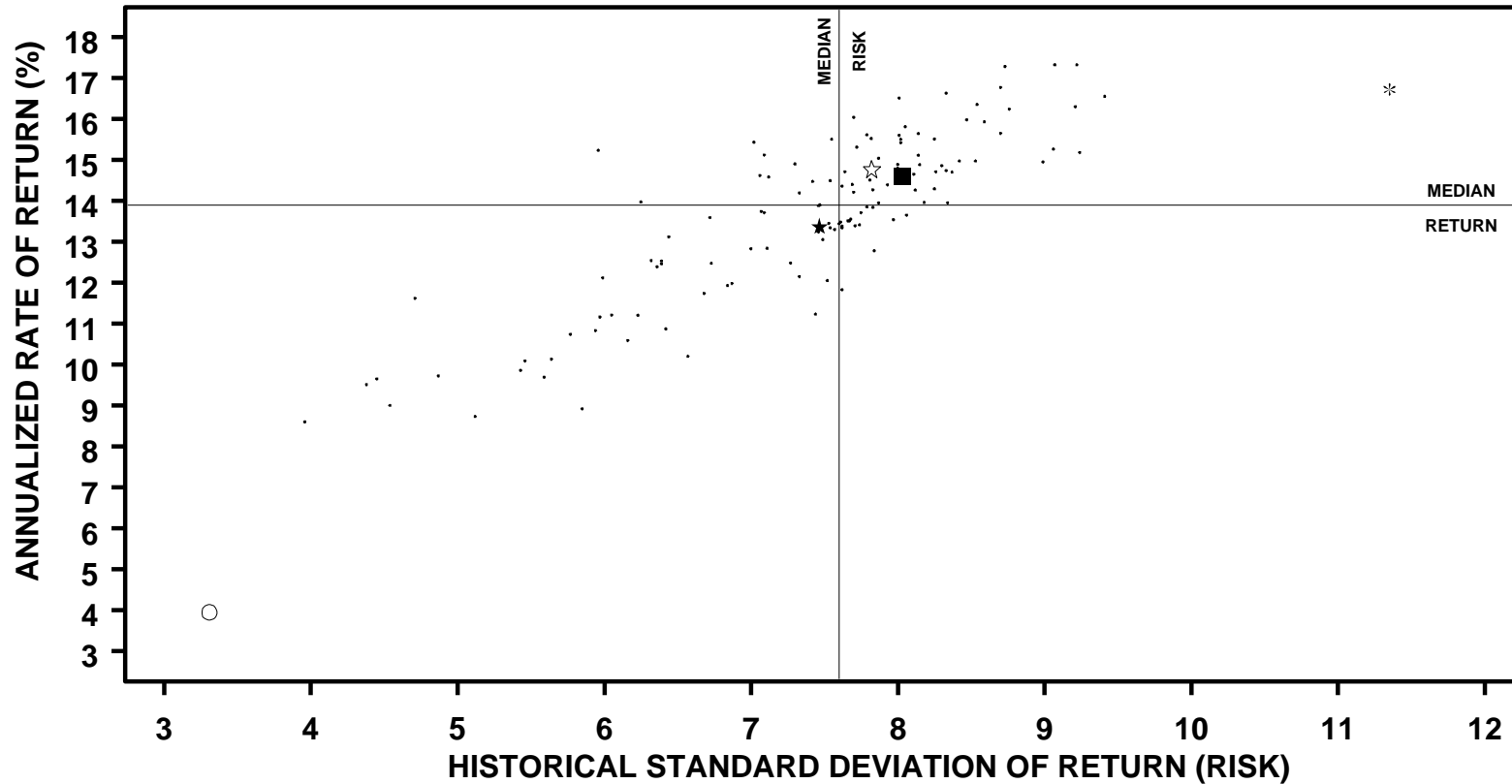

	ANNUALIZED RETURN		STANDARD DEVIATION		SHARPE RATIO	
	VALUE	RANK	VALUE	RANK	VALUE	RANK
★ MUNI COMPOSITE	13.4	63	7.5	58	1.5	59
■ ALLOC INDEX	14.6	39	8.0	29	1.6	48
☆ POLICY INDEX	14.8	34	7.8	38	1.6	34
* S&P 500	16.7	8	11.4	1	1.3	96
○ LB AGGREGATE	4.0	100	3.3	97	0.7	100
MEDIAN	13.9		7.6		1.6	

VERMONT MUNICIPAL EMPLOYEES

TOTAL PUBLIC FUNDS - TOTAL RETURN VS RISK

5 YEARS ENDING 9/05

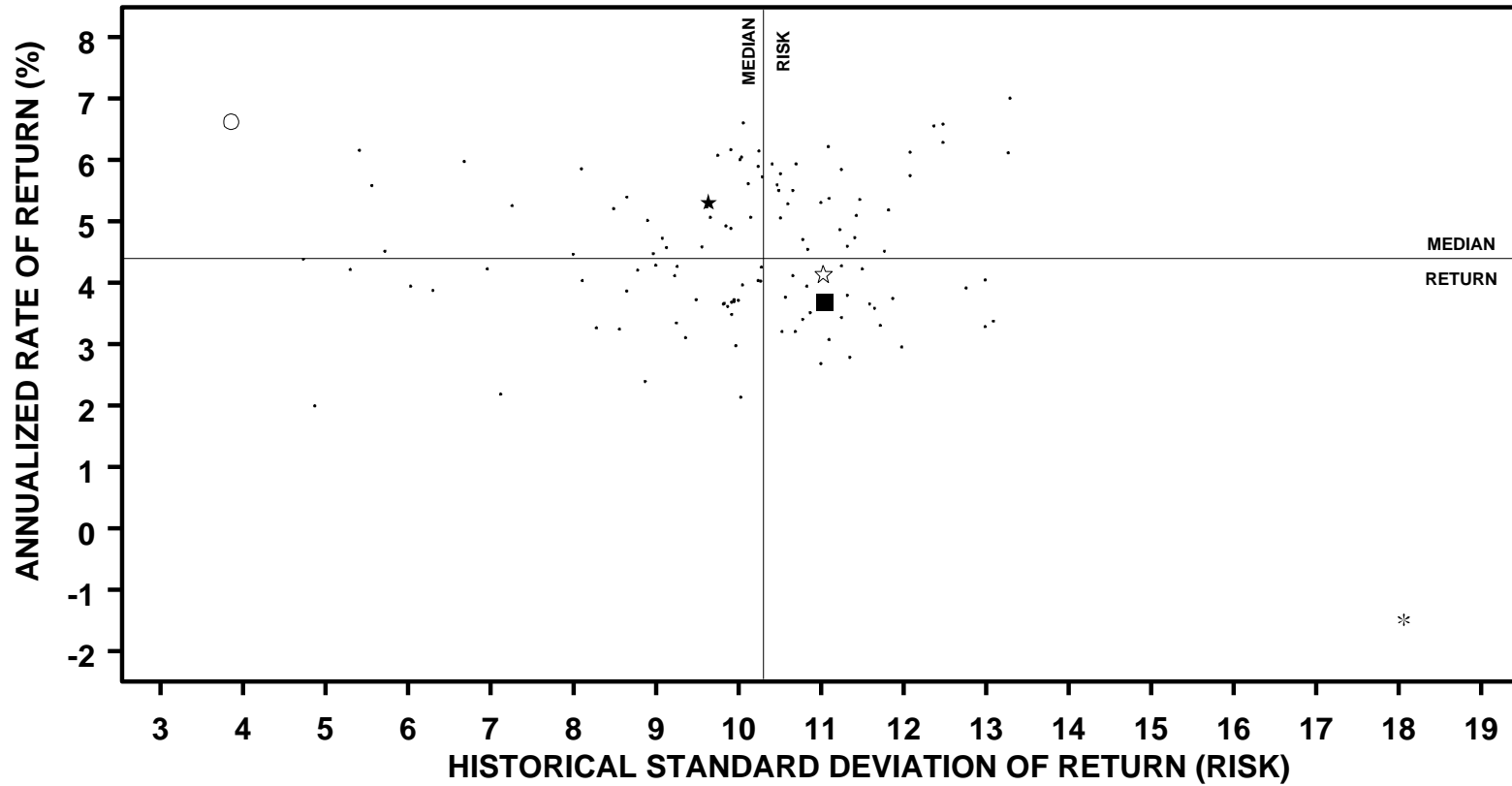

	ANNUALIZED RETURN		STANDARD DEVIATION		SHARPE RATIO	
	VALUE	RANK	VALUE	RANK	VALUE	RANK
★ MUNI COMPOSITE	5.3	31	9.6	67	0.3	30
■ ALLOC INDEX	3.7	74	11.1	32	0.2	74
☆ POLICY INDEX	4.2	57	11.0	32	0.2	60
* S&P 500	-1.5	100	18.1	1	-0.1	
○ LB AGGREGATE	6.6	5	3.9	99	1.1	1
MEDIAN	4.4		10.3		0.3	

VERMONT MUNICIPAL EMPLOYEES

EQUITY LARGE FUNDS - TOTAL RATES OF RETURN

PERIODS ENDING 9/05

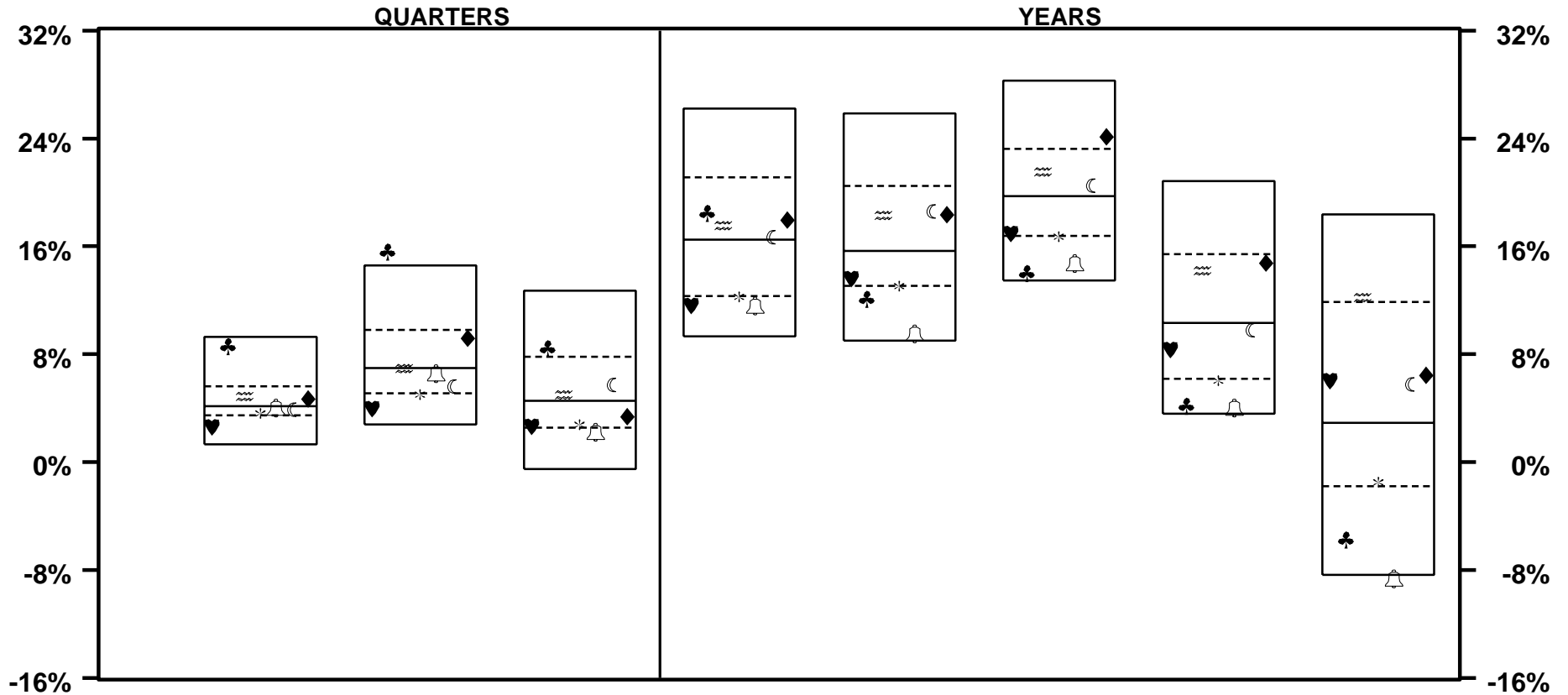

	LAST QTR		LAST 2 QTRS		LAST 3 QTRS		LAST YEAR		LAST 2 YEARS		LAST 3 YEARS		LAST 4 YEARS		LAST 5 YEARS	
♥ DELAWARE	2.6	86	4.0	89	2.7	73	11.6	85	13.6	66	17.0	71	8.4	59	6.1	43
♣ ALLIANCE	8.6	6	15.6	3	8.4	21	18.5	38	12.1	84	14.0	93	4.2	91	-5.7	90
≈ LAZARD	4.9	39	7.0	50	5.0	47	17.5	42	18.3	33	21.5	39	14.2	27	12.2	20
* S&P 500	3.6	71	5.0	78	2.8	72	12.3	81	13.1	75	16.7	77	6.0	79	-1.5	70
🔔 R 1000(R) GR	4.0	55	6.6	53	2.2	79	11.6	85	9.5	93	14.7	92	4.0	93	-8.6	95
☾ R 1000(R) VALUE	3.9	58	5.6	67	5.7	41	16.7	47	18.6	31	20.5	44	9.8	51	5.8	43
◆ R 2000(R)	4.7	40	9.2	30	3.4	63	18.0	40	18.4	32	24.1	19	14.8	26	6.4	40
MEDIAN	4.1		7.0		4.6		16.5		15.6		19.7		10.3		2.9	

VERMONT MUNICIPAL EMPLOYEES

EQUITY LARGE FUNDS - TOTAL RATES OF RETURN

PERIODS ENDING 9/05

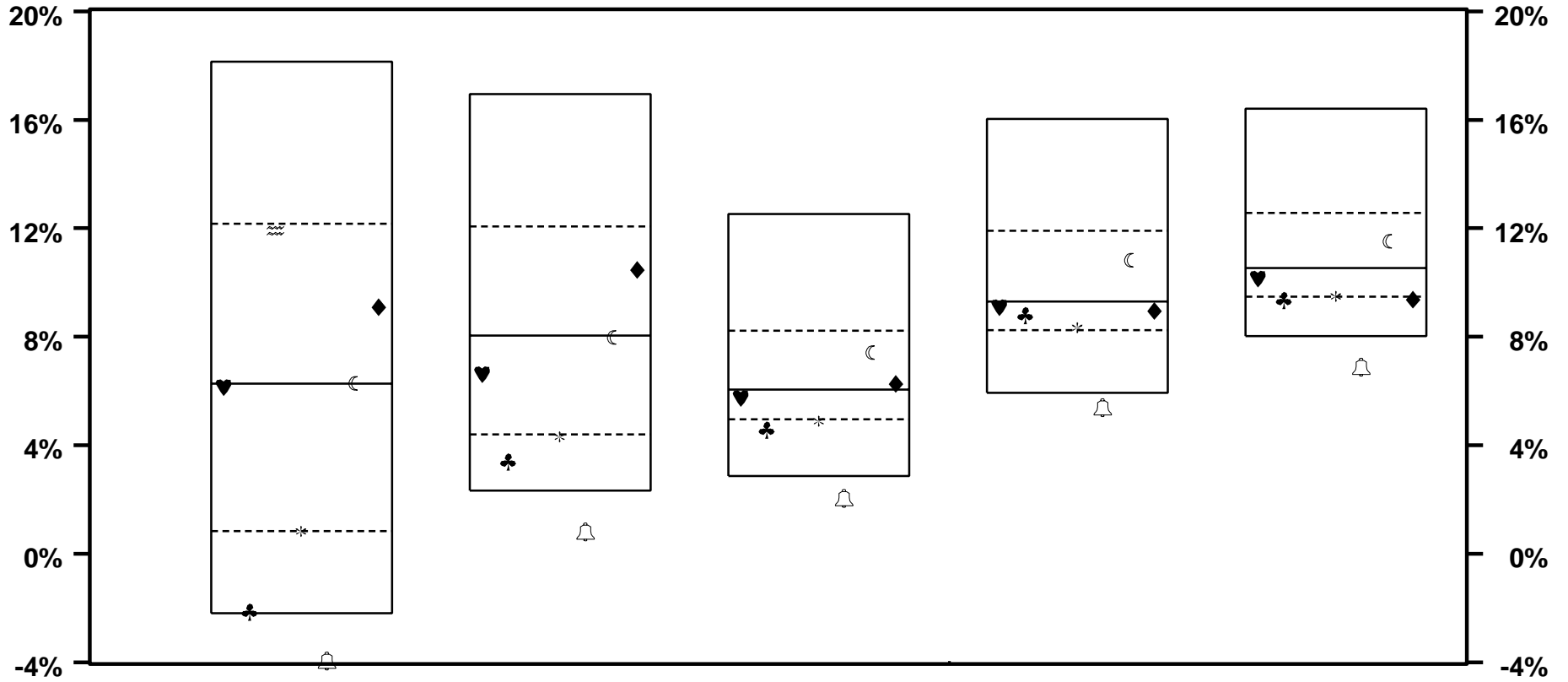

	LAST 6 YEARS		LAST 7 YEARS		LAST 8 YEARS		LAST 9 YEARS		LAST 10 YEARS	
♥ DELAWARE	6.1	52	6.6	57	5.7	62	9.1	51	10.2	57
♣ ALLIANCE	-2.1	94	3.4	91	4.6	88	8.8	52	9.4	77
≈ LAZARD	11.9	26								
* S&P 500	0.8	75	4.3	80	4.9	79	8.3	72	9.5	73
🔔 R 1000(R) GR	-3.9	98	0.8	100	2.1	99	5.4	99	6.9	99
☾ R 1000(R) VALUE	6.3	49	8.0	50	7.4	31	10.8	32	11.5	34
♦ R 2000(R)	9.1	38	10.5	37	6.3	46	9.0	52	9.4	77
MEDIAN	6.3		8.1		6.1		9.3		10.5	

VERMONT MUNICIPAL EMPLOYEES

EQUITY LARGE FUNDS - TOTAL RATES OF RETURN

YEARS ENDING

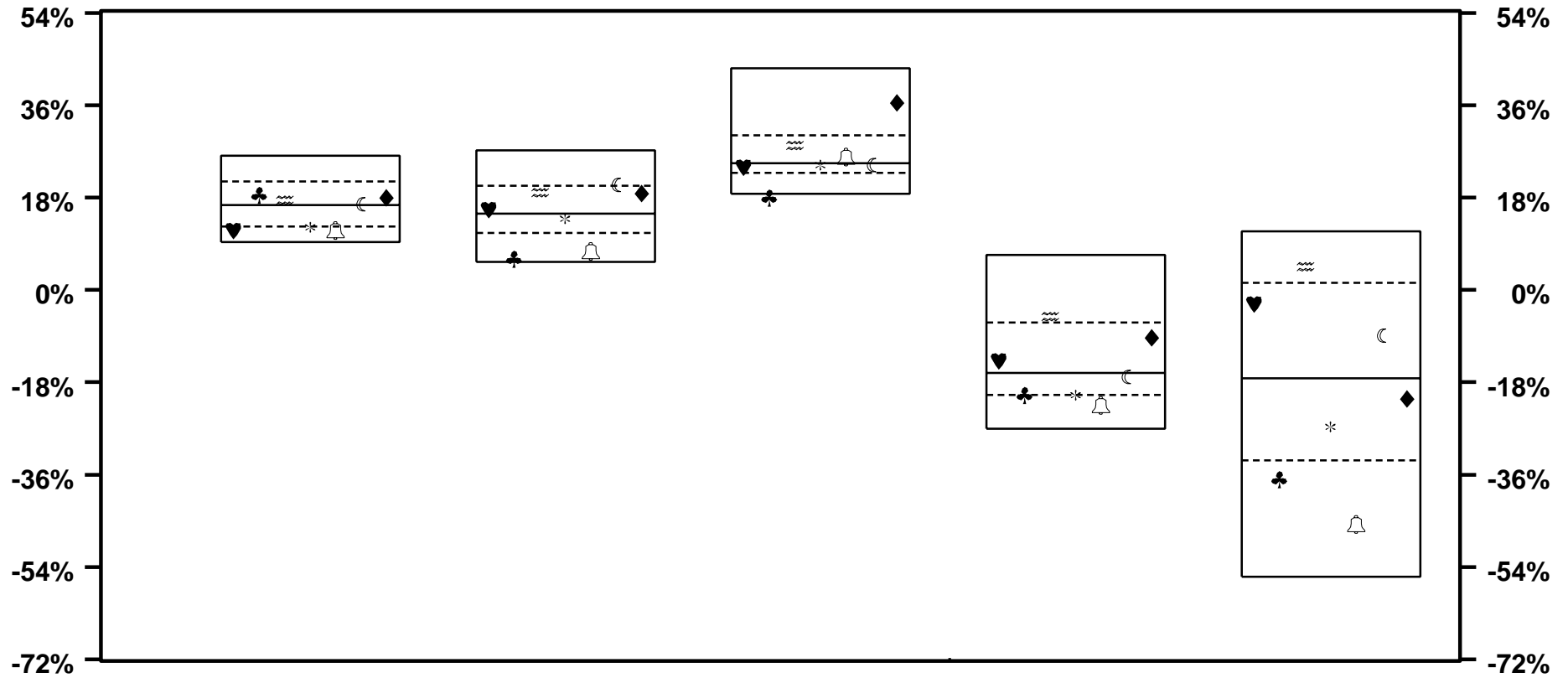

	9 / 05		9 / 04		9 / 03		9 / 02		9 / 01	
♥ DELAWARE	11.6	85	15.7	45	24.0	66	-13.8	44	-2.7	31
♣ ALLIANCE	18.5	38	6.1	93	18.0	97	-20.5	76	-36.9	81
≈ LAZARD	17.5	42	19.1	31	28.2	31	-5.2	21	4.6	20
* S&P 500	12.3	81	13.9	59	24.4	55	-20.5	76	-26.6	64
🔔 R 1000(R) GR	11.6	85	7.5	88	25.9	39	-22.5	86	-45.6	91
☾ R 1000(R) VALUE	16.7	47	20.5	23	24.4	58	-17.0	52	-8.9	40
◆ R 2000(R)	18.0	40	18.8	32	36.5	12	-9.3	31	-21.2	52
MEDIAN	16.5		14.8		24.7		-16.2		-17.2	

VERMONT MUNICIPAL EMPLOYEES

EQUITY LARGE FUNDS - TOTAL RATES OF RETURN

YEARS ENDING

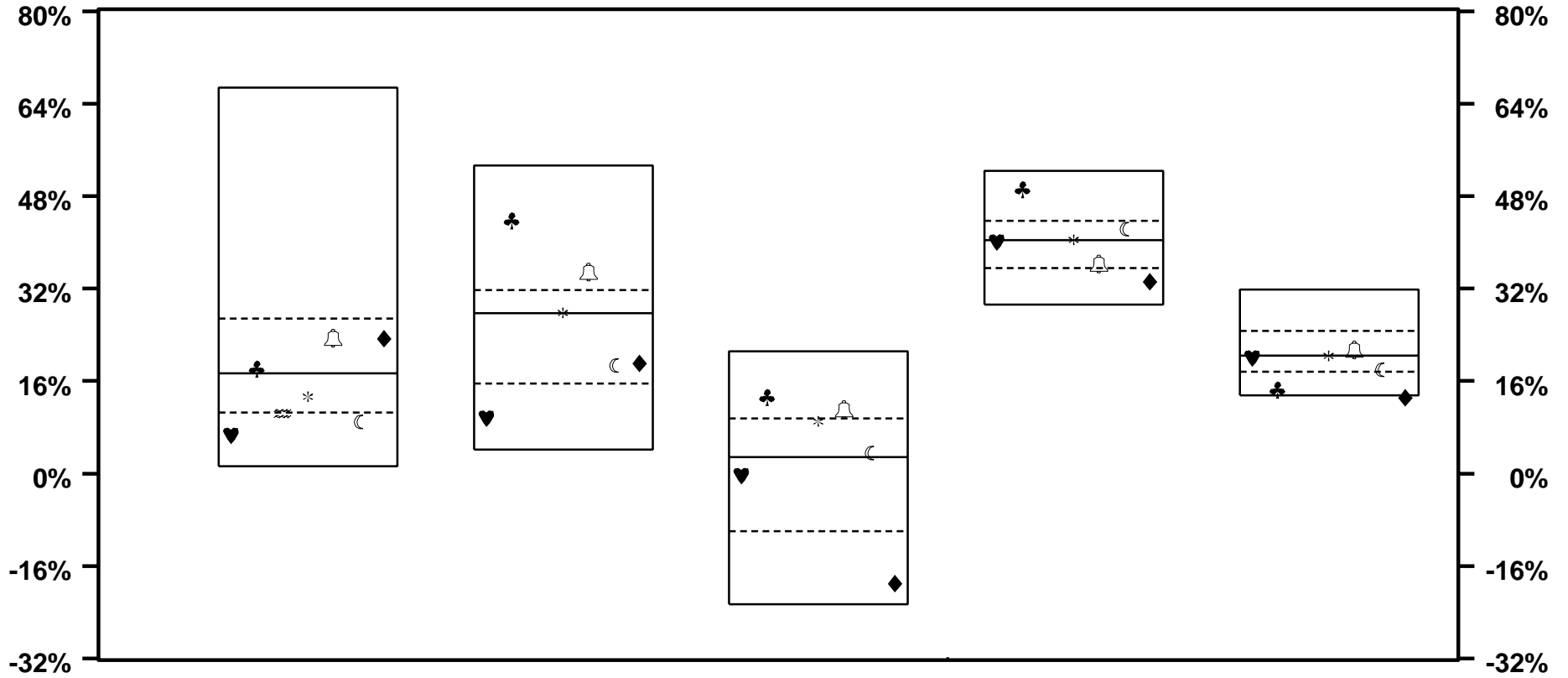

	9 / 00		9 / 99		9 / 98		9 / 97		9 / 96	
♥ DELAWARE	6.6	88	9.6	89	- 0.3	59	40.1	55	20.1	59
♣ ALLIANCE	18.1	45	43.8	9	13.2	15	49.2	9	14.5	91
≈ LAZARD	10.4	75								
* S&P 500	13.3	64	27.8	47	9.0	36	40.4	49	20.3	50
🔔 R 1000(R) GR	23.4	28	34.9	20	11.1	16	36.3	72	21.4	42
☾ R 1000(R) VALUE	8.9	81	18.7	69	3.6	46	42.3	31	17.9	73
◆ R 2000(R)	23.4	28	19.1	68	- 19.0	90	33.2	85	13.1	96
MEDIAN	17.3		27.7		2.9		40.4		20.4	

VERMONT MUNICIPAL EMPLOYEES

EQUITY LARGE FUNDS - TOTAL RETURN VS RISK

3 YEARS ENDING 9/05

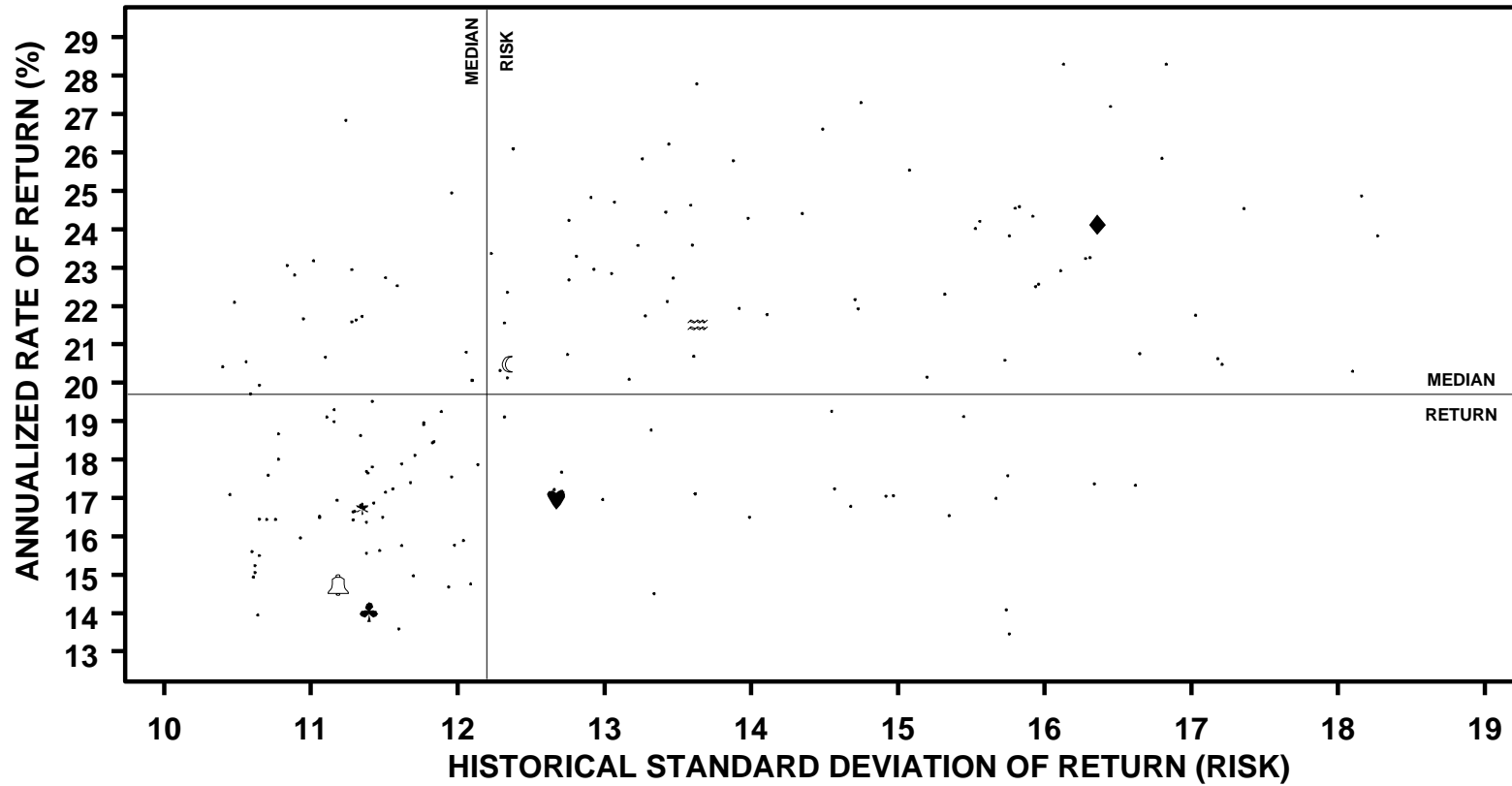

	ANNUALIZED RETURN		STANDARD DEVIATION		SHARPE RATIO	
	VALUE	RANK	VALUE	RANK	VALUE	RANK
♥ DELAWARE	17.0	71	12.7	45	1.2	76
♣ ALLIANCE	14.0	93	11.4	68	1.1	85
≈ LAZARD	21.5	39	13.6	31	1.4	41
* S&P 500	16.7	77	11.4	71	1.3	60
🔔 R 1000(R) GR	14.7	92	11.2	79	1.2	79
☾ R 1000(R) VALUE	20.5	44	12.3	47	1.5	32
♦ R 2000(R)	24.1	19	16.4	11	1.3	52
MEDIAN	19.7		12.2		1.4	

VERMONT MUNICIPAL EMPLOYEES

EQUITY LARGE FUNDS - TOTAL RETURN VS RISK

5 YEARS ENDING 9/05

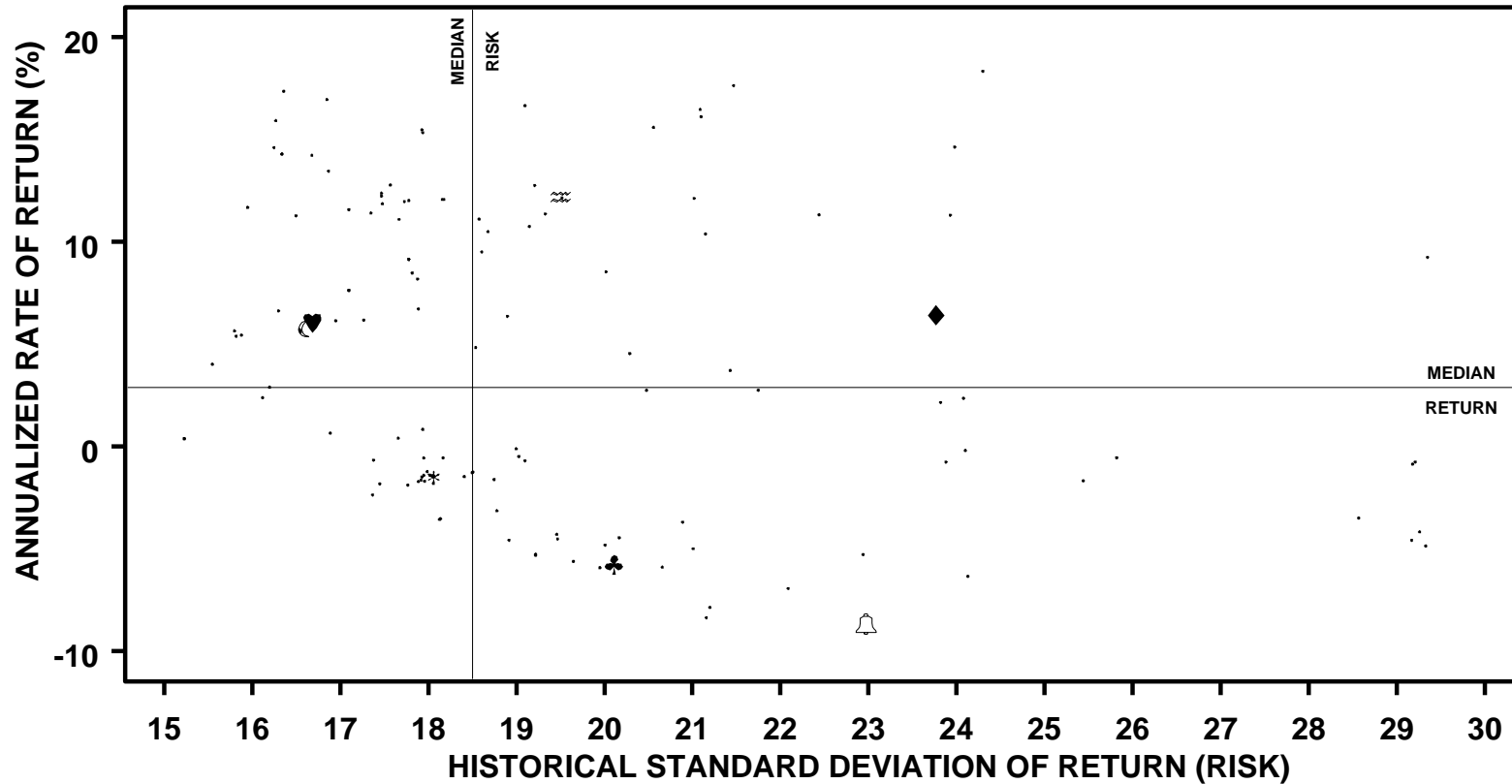

	ANNUALIZED RETURN		STANDARD DEVIATION		SHARPE RATIO	
	VALUE	RANK	VALUE	RANK	VALUE	RANK
♥ DELAWARE	6.1	43	16.7	82	0.3	42
♣ ALLIANCE	-5.7	90	20.1	32	-0.3	
≈ LAZARD	12.2	20	19.5	36	0.6	26
* S&P 500	-1.5	70	18.1	54	-0.1	
🔔 R 1000(R) GR	-8.6	95	23.0	17	-0.4	
☾ R 1000(R) VALUE	5.8	43	16.6	84	0.3	44
♦ R 2000(R)	6.4	40	23.8	17	0.3	43
MEDIAN	2.9		18.5		0.1	

VERMONT MUNICIPAL EMPLOYEES

EQUITY PUBLIC FUNDS - TOTAL RATES OF RETURN

PERIODS ENDING 9/05

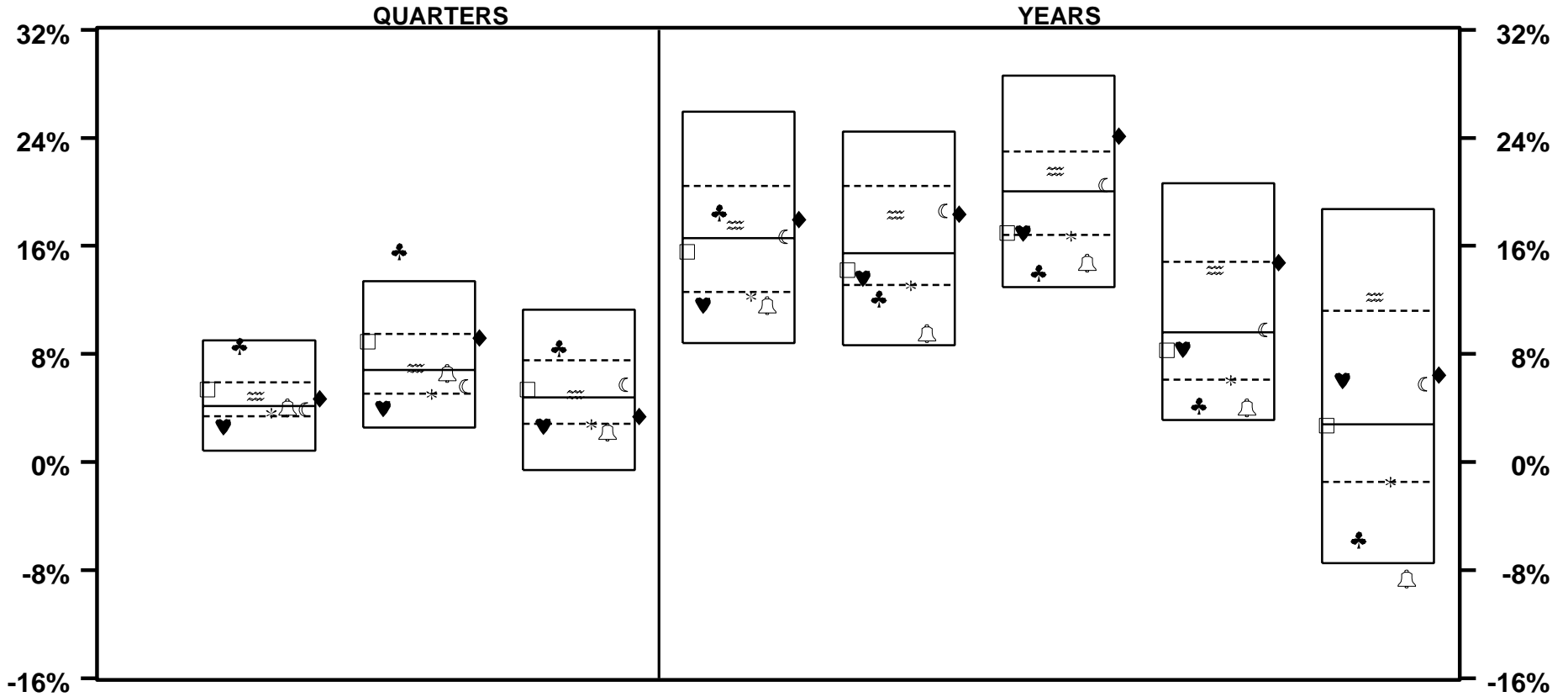

	LAST QTR		LAST 2 QTRS		LAST 3 QTRS		LAST YEAR		LAST 2 YEARS		LAST 3 YEARS		LAST 4 YEARS		LAST 5 YEARS	
□ EQTY COMPOSITE	5.4	30	8.9	29	5.4	43	15.6	57	14.2	61	17.0	72	8.3	57	2.7	50
♥ DELAWARE	2.6	84	4.0	87	2.7	79	11.6	86	13.6	67	17.0	72	8.4	56	6.1	40
♣ ALLIANCE	8.6	6	15.6	2	8.4	19	18.5	36	12.1	85	14.0	90	4.2	88	-5.7	91
≡ LAZARD	4.9	39	7.0	46	5.0	47	17.5	43	18.3	36	21.5	37	14.2	27	12.2	20
* S&P 500	3.6	68	5.0	77	2.8	78	12.3	82	13.1	78	16.7	78	6.0	79	-1.5	75
🔔 R 1000(R) GR	4.0	54	6.6	51	2.2	83	11.6	86	9.5	93	14.7	88	4.0	90	-8.6	96
☾ R 1000(R) VALUE	3.9	58	5.6	68	5.7	41	16.7	49	18.6	33	20.5	45	9.8	49	5.8	41
◆ R 2000(R)	4.7	43	9.2	27	3.4	68	18.0	39	18.4	34	24.1	19	14.8	25	6.4	37
MEDIAN	4.2		6.8		4.8		16.6		15.5		20.1		9.6		2.8	

VERMONT MUNICIPAL EMPLOYEES

EQUITY PUBLIC FUNDS - TOTAL RATES OF RETURN

PERIODS ENDING 9/05

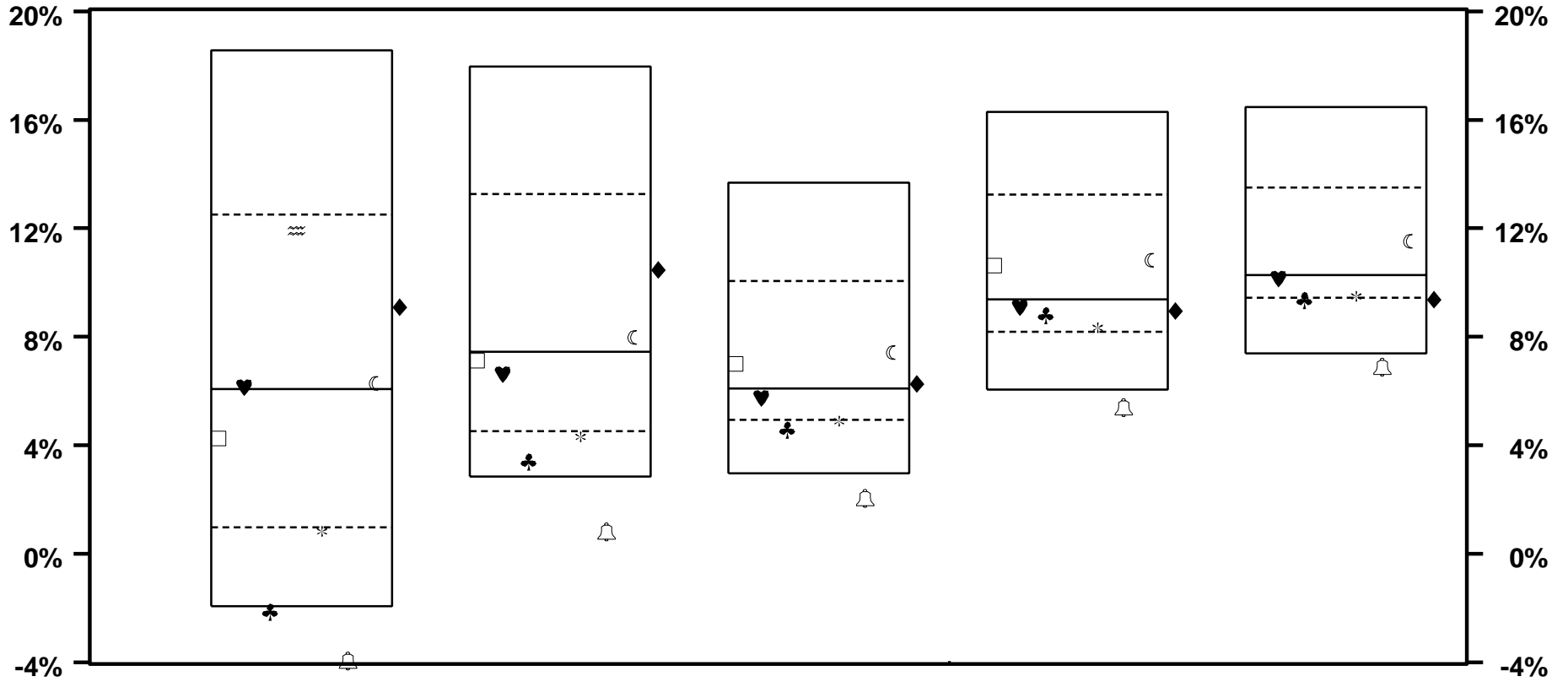

	LAST 6 YEARS		LAST 7 YEARS		LAST 8 YEARS		LAST 9 YEARS		LAST 10 YEARS	
□ EQTY COMPOSITE	4.3	60	7.1	50	7.0	39	10.6	34		
♥ DELAWARE	6.1	48	6.6	56	5.7	58	9.1	53	10.2	53
♣ ALLIANCE	-2.1	95	3.4	92	4.6	84	8.8	56	9.4	77
≈ LAZARD	11.9	26								
* S&P 500	0.8	81	4.3	80	4.9	76	8.3	74	9.5	72
🔔 R 1000(R) GR	-3.9	98	0.8	99	2.1	97	5.4	96	6.9	95
☾ R 1000(R) VALUE	6.3	46	8.0	46	7.4	36	10.8	32	11.5	36
◆ R 2000(R)	9.1	34	10.5	38	6.3	46	9.0	55	9.4	75
MEDIAN	6.1		7.5		6.1		9.4		10.3	

VERMONT MUNICIPAL EMPLOYEES

EQUITY PUBLIC FUNDS - TOTAL RATES OF RETURN

YEARS ENDING

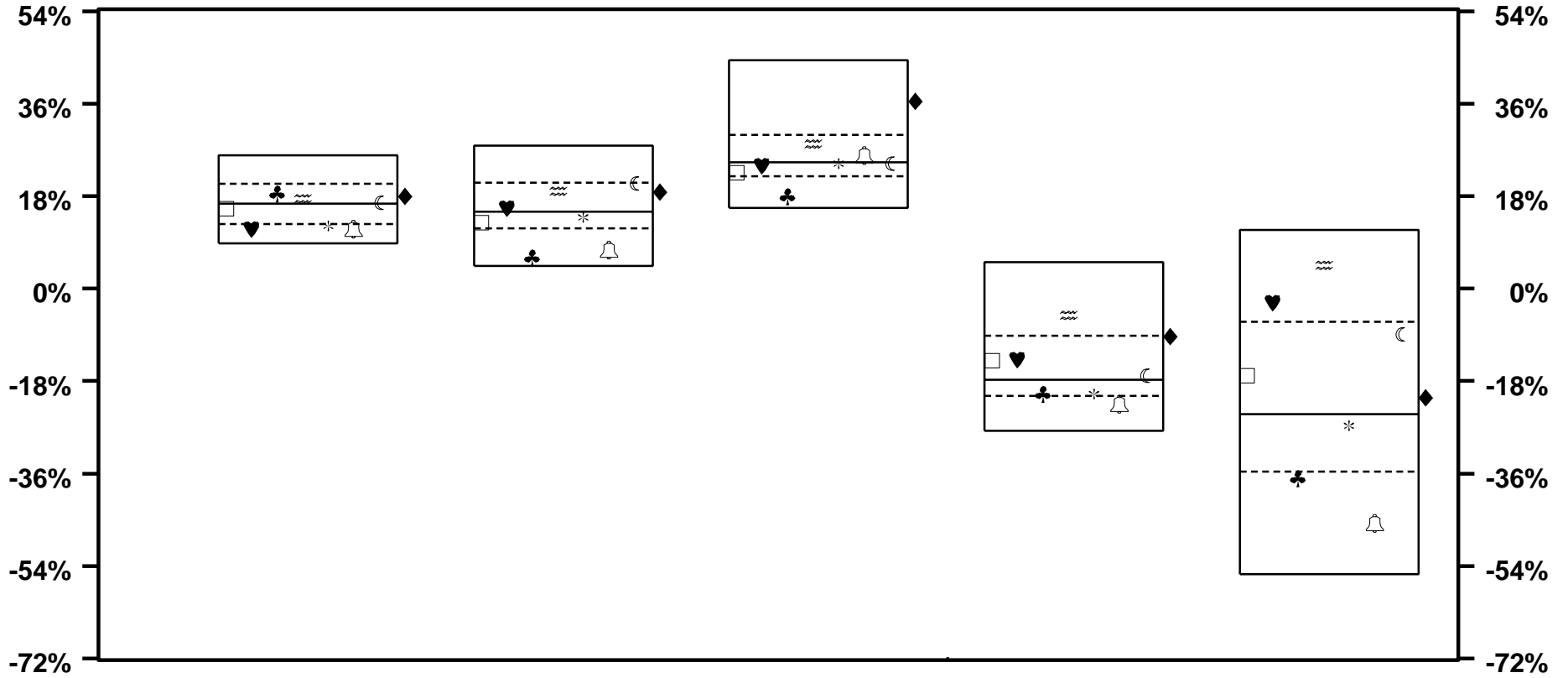

	9 / 05		9 / 04		9 / 03		9 / 02		9 / 01	
□ EQTY COMPOSITE	15.6	57	12.9	69	22.6	71	-14.0	37	-16.9	40
♥ DELAWARE	11.6	86	15.7	46	24.0	63	-13.8	36	-2.7	20
♣ ALLIANCE	18.5	36	6.1	92	18.0	90	-20.5	72	-36.9	76
≈ LAZARD	17.5	43	19.1	31	28.2	30	-5.2	18	4.6	11
* S&P 500	12.3	82	13.9	61	24.4	54	-20.5	71	-26.6	61
🔔 R 1000(R) GR	11.6	86	7.5	87	25.9	40	-22.5	84	-45.6	88
☾ R 1000(R) VALUE	16.7	49	20.5	25	24.4	56	-17.0	46	-8.9	29
◆ R 2000(R)	18.0	39	18.8	33	36.5	13	-9.3	25	-21.2	47
MEDIAN	16.6		15.0		24.6		-17.7		-24.4	

VERMONT MUNICIPAL EMPLOYEES

EQUITY PUBLIC FUNDS - TOTAL RATES OF RETURN

YEARS ENDING

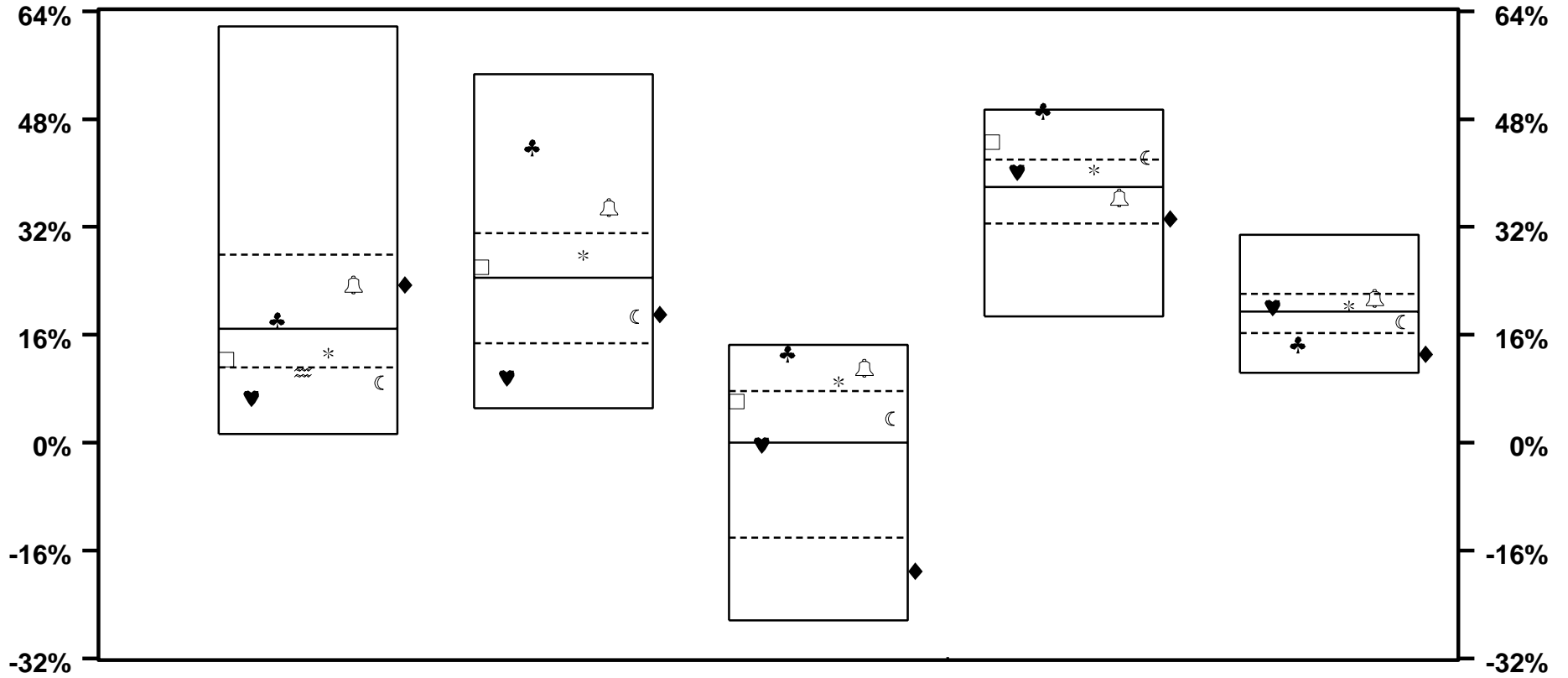

	9 / 00		9 / 99		9 / 98		9 / 97		9 / 96	
□ EQTY COMPOSITE	12.3	71	26.1	46	6.1	28	44.6	16		
♥ DELAWARE	6.6	85	9.6	88	-0.3	51	40.1	37	20.1	45
♣ ALLIANCE	18.1	45	43.8	9	13.2	6	49.2	5	14.5	83
≍ LAZARD	10.4	76								
* S&P 500	13.3	65	27.8	37	9.0	20	40.4	35	20.3	42
🔔 R 1000(R) GR	23.4	32	34.9	18	11.1	10	36.3	57	21.4	29
☾ R 1000(R) VALUE	8.9	80	18.7	64	3.6	35	42.3	23	17.9	63
◆ R 2000(R)	23.4	32	19.1	64	-19.0	84	33.2	73	13.1	88
MEDIAN	16.9		24.4		0.0		37.9		19.5	

VERMONT MUNICIPAL EMPLOYEES

EQUITY PUBLIC FUNDS - TOTAL RETURN VS RISK

3 YEARS ENDING 9/05

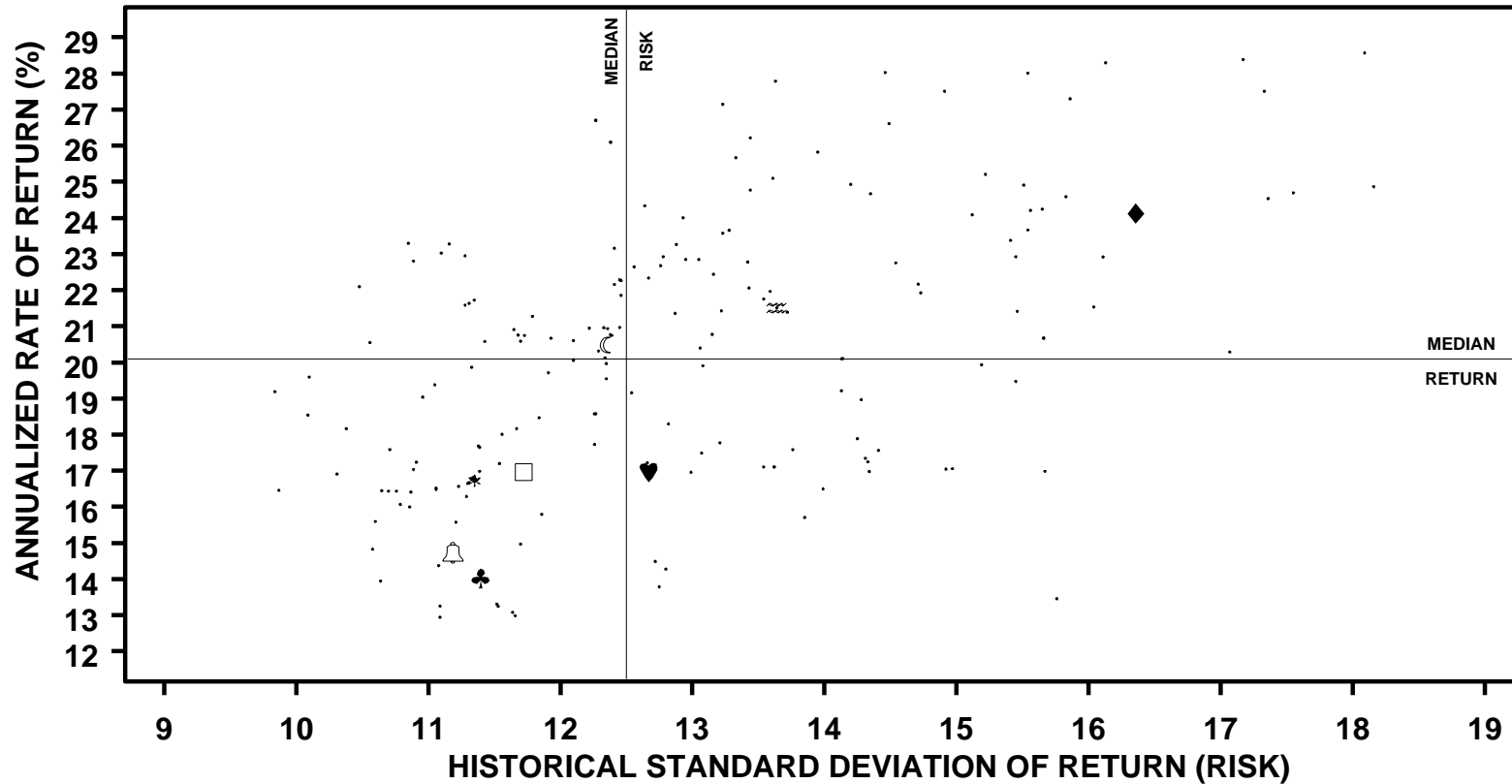

	ANNUALIZED RETURN		STANDARD DEVIATION		SHARPE RATIO	
	VALUE	RANK	VALUE	RANK	VALUE	RANK
□ EQTY COMPOSITE	17.0	72	11.7	63	1.3	66
♥ DELAWARE	17.0	72	12.7	47	1.2	75
♣ ALLIANCE	14.0	90	11.4	68	1.1	84
≍ LAZARD	21.5	37	13.6	33	1.4	40
* S&P 500	16.7	78	11.4	71	1.3	60
🔔 R 1000(R) GR	14.7	88	11.2	79	1.2	78
☾ R 1000(R) VALUE	20.5	45	12.3	54	1.5	32
◆ R 2000(R)	24.1	19	16.4	11	1.3	52
MEDIAN	20.1		12.5		1.4	

VERMONT MUNICIPAL EMPLOYEES

EQUITY PUBLIC FUNDS - TOTAL RETURN VS RISK

5 YEARS ENDING 9/05

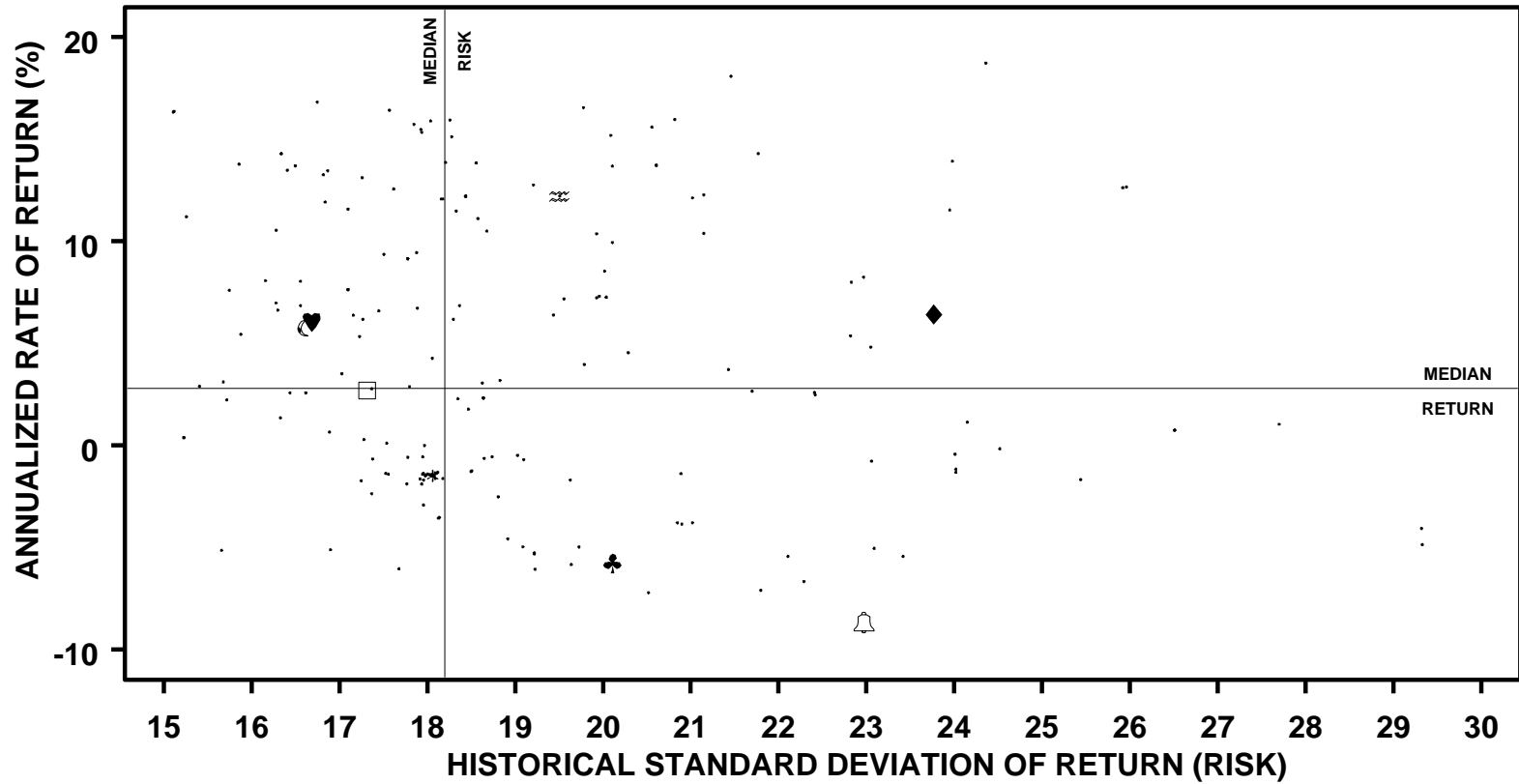

	ANNUALIZED RETURN		STANDARD DEVIATION		SHARPE RATIO	
	VALUE	RANK	VALUE	RANK	VALUE	RANK
□ EQTY COMPOSITE	2.7	50	17.3	72	0.1	51
♥ DELAWARE	6.1	40	16.7	80	0.3	39
♣ ALLIANCE	-5.7	91	20.1	29	-0.3	
≈ LAZARD	12.2	20	19.5	36	0.6	21
* S&P 500	-1.5	75	18.1	53	-0.1	
🔔 R 1000(R) GR	-8.6	96	23.0	16	-0.4	
☾ R 1000(R) VALUE	5.8	41	16.6	81	0.3	41
◆ R 2000(R)	6.4	37	23.8	14	0.3	40
MEDIAN	2.8		18.2		0.1	

VERMONT MUNICIPAL EMPLOYEES

EQUITY ONLY LARGE FUNDS - RATES OF RETURN

PERIODS ENDING 9/05

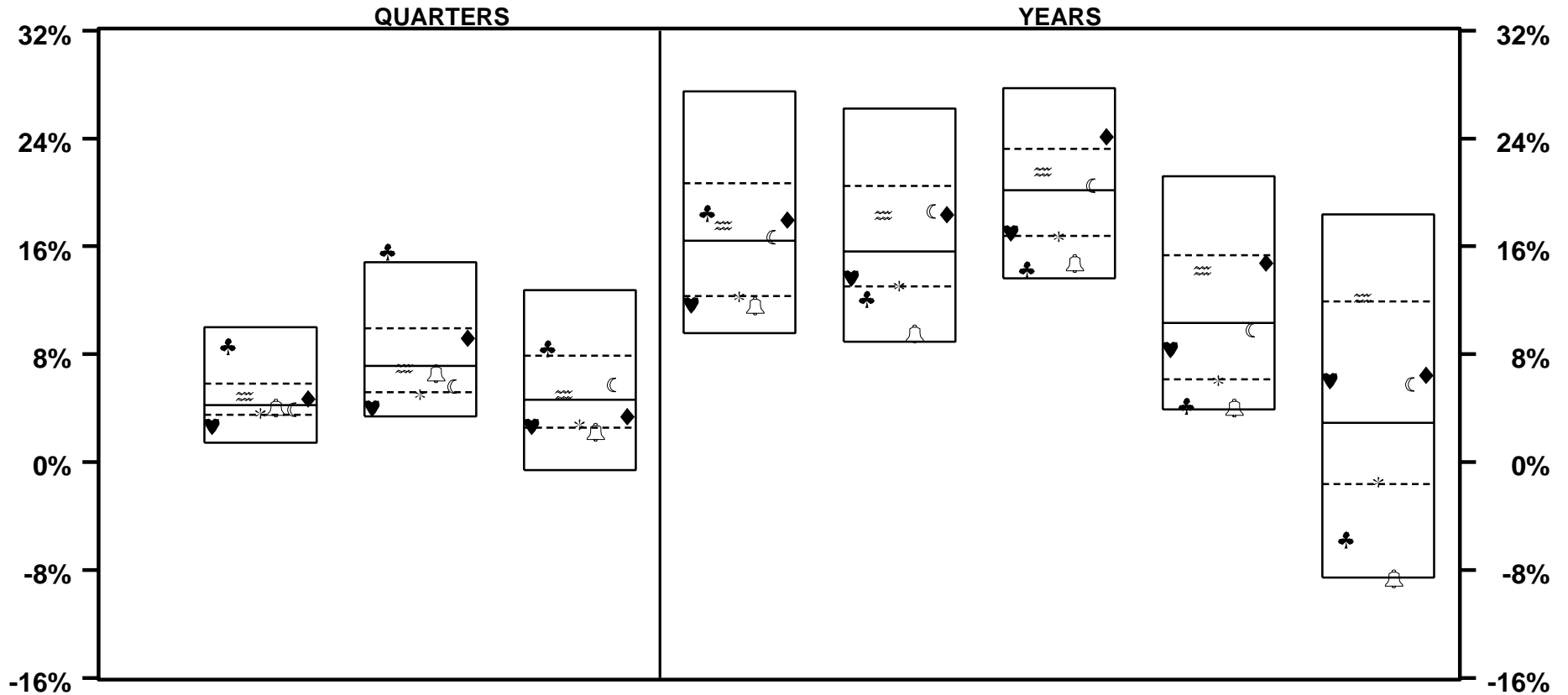

	LAST QTR		LAST 2 QTRS		LAST 3 QTRS		LAST YEAR		LAST 2 YEARS		LAST 3 YEARS		LAST 4 YEARS		LAST 5 YEARS	
♥ DELAWARE	2.7	86	4.0	90	2.7	73	11.7	85	13.7	66	17.0	71	8.4	60	6.1	42
♣ ALLIANCE	8.6	8	15.6	3	8.4	22	18.5	37	12.1	84	14.3	92	4.2	91	-5.8	91
≈ LAZARD	4.9	41	7.0	51	5.0	47	17.5	41	18.3	35	21.5	41	14.2	28	12.2	24
* S&P 500	3.6	72	5.0	78	2.8	73	12.3	80	13.1	74	16.7	78	6.0	79	-1.5	73
🔔 R 1000(R) GR	4.0	56	6.6	54	2.2	80	11.6	85	9.5	92	14.7	91	4.0	94	-8.6	95
☾ R 1000(R) VALUE	3.9	61	5.6	69	5.7	41	16.7	47	18.6	32	20.5	47	9.8	51	5.8	42
◆ R 2000(R)	4.7	43	9.2	33	3.4	63	18.0	40	18.4	33	24.1	19	14.8	25	6.4	40
MEDIAN	4.2		7.1		4.6		16.4		15.6		20.1		10.3		2.9	

VERMONT MUNICIPAL EMPLOYEES

EQUITY ONLY LARGE FUNDS - RATES OF RETURN

PERIODS ENDING 9/05

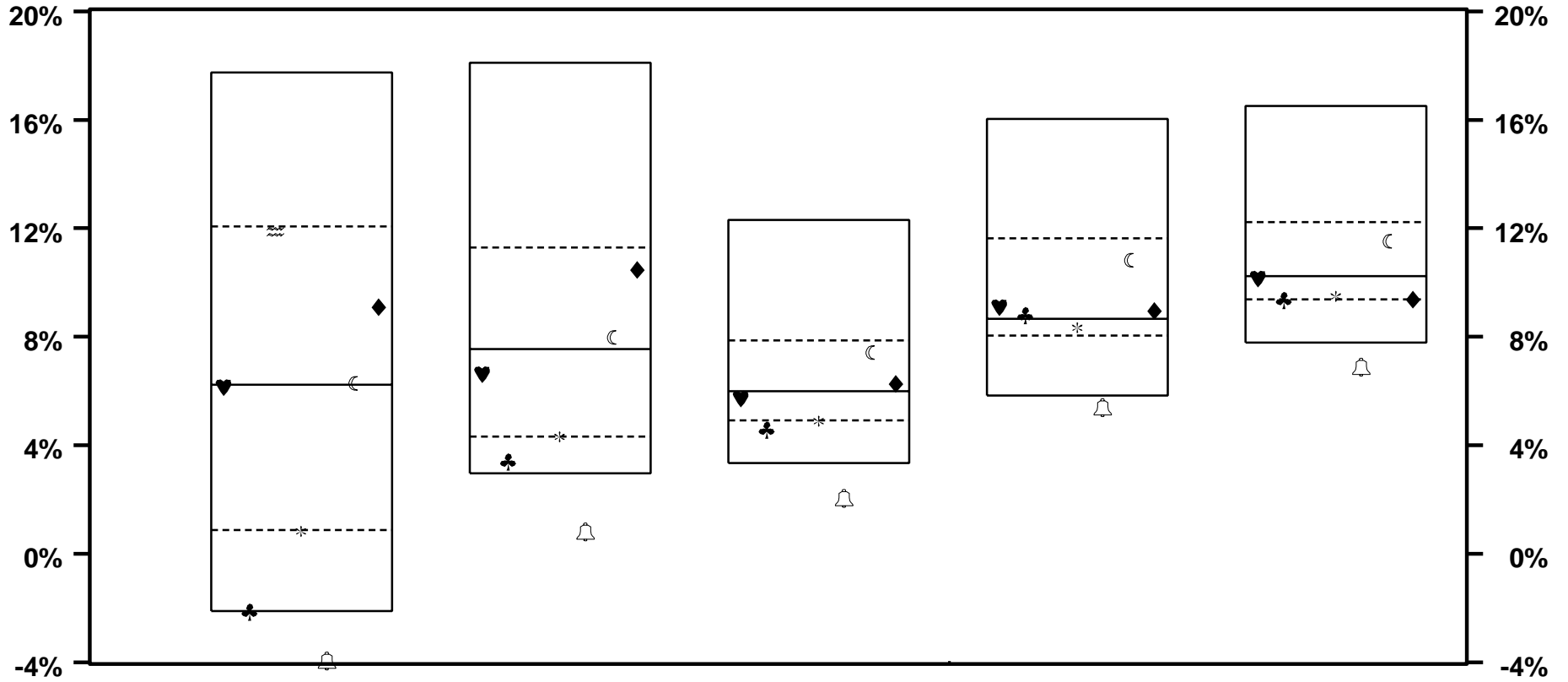

	LAST 6 YEARS		LAST 7 YEARS		LAST 8 YEARS		LAST 9 YEARS		LAST 10 YEARS	
♥ DELAWARE	6.1	52	6.6	54	5.7	56	9.1	44	10.1	52
♣ ALLIANCE	-2.1	95	3.4	91	4.6	87	8.8	46	9.4	75
≈ LAZARD	11.9	26								
* S&P 500	0.8	77	4.3	75	4.9	78	8.3	69	9.5	70
🔔 R 1000(R) GR	-3.9	97	0.8	99	2.1	97	5.4	98	6.9	98
☾ R 1000(R) VALUE	6.3	49	8.0	48	7.4	31	10.8	29	11.5	33
◆ R 2000(R)	9.1	32	10.5	29	6.3	43	9.0	45	9.4	74
MEDIAN	6.2		7.5		6.0		8.7		10.2	

VERMONT MUNICIPAL EMPLOYEES

EQUITY ONLY LARGE FUNDS - RATES OF RETURN

YEARS ENDING

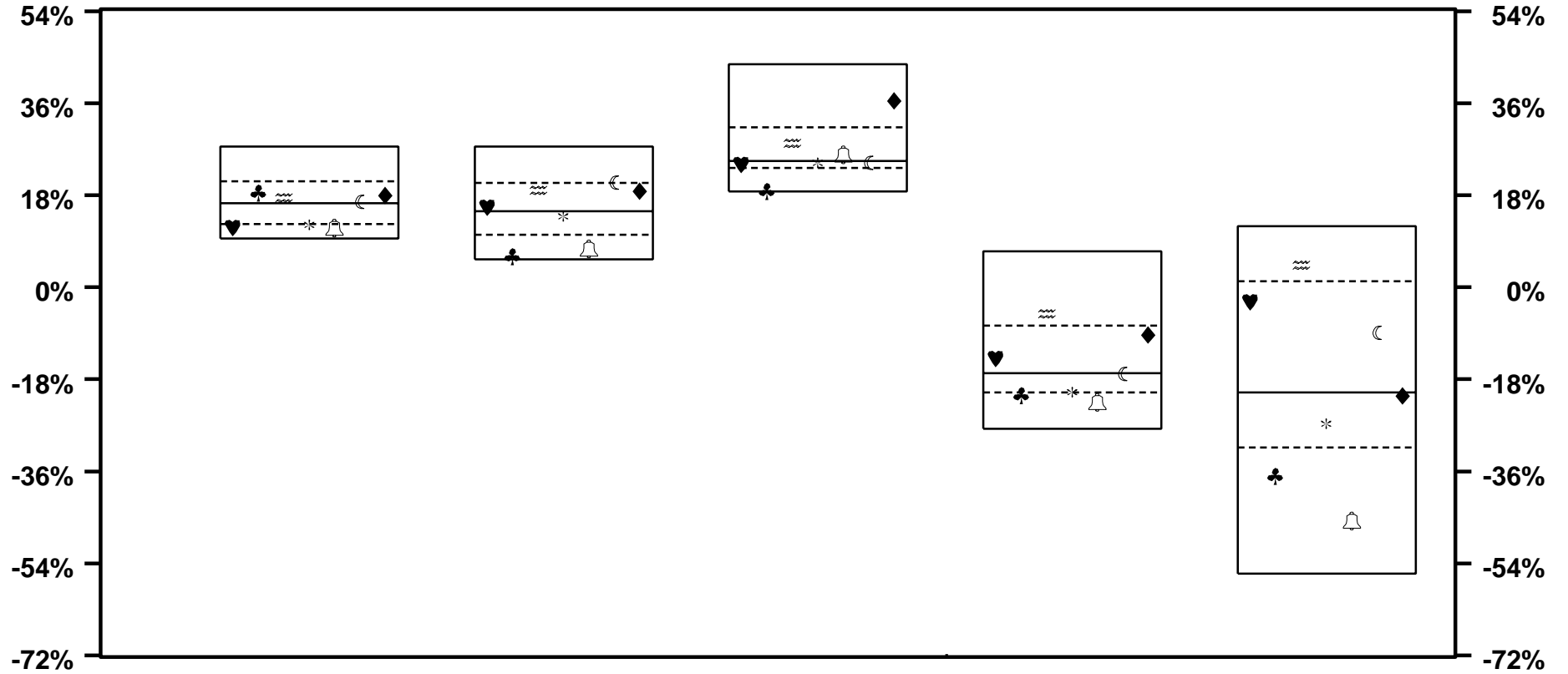

	9 / 05		9 / 04		9 / 03		9 / 02		9 / 01	
♥ DELAWARE	11.7	85	15.7	45	24.0	67	-13.9	43	-2.8	28
♣ ALLIANCE	18.5	37	6.1	93	18.8	94	-21.1	80	-36.9	82
≈ LAZARD	17.5	41	19.1	33	28.2	31	-5.2	20	4.4	20
* S&P 500	12.3	80	13.9	60	24.4	62	-20.5	74	-26.6	64
🔔 R 1000(R) GR	11.6	85	7.5	88	25.9	39	-22.5	84	-45.6	90
☾ R 1000(R) VALUE	16.7	47	20.5	24	24.4	62	-17.0	50	-8.9	38
◆ R 2000(R)	18.0	40	18.8	33	36.5	12	-9.3	29	-21.2	50
MEDIAN	16.4		14.9		24.7		-16.9		-20.6	

VERMONT MUNICIPAL EMPLOYEES

EQUITY ONLY LARGE FUNDS - RATES OF RETURN

YEARS ENDING

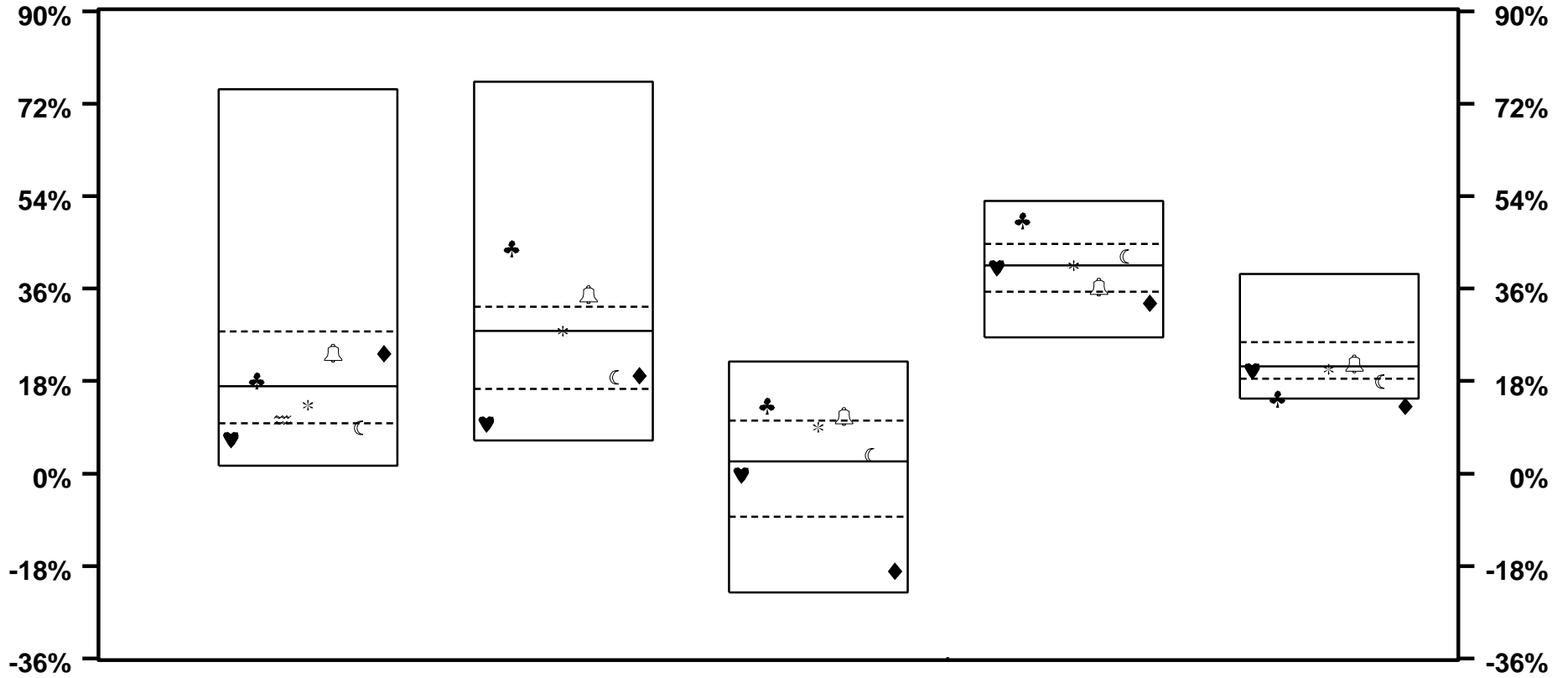

	9 / 00		9 / 99		9 / 98		9 / 97		9 / 96	
♥ DELAWARE	6.6	85	9.6	89	-0.3	56	40.1	56	20.1	64
♣ ALLIANCE	18.1	48	43.8	12	13.2	17	49.2	17	14.5	95
≍ LAZARD	10.4	72								
* S&P 500	13.3	63	27.8	48	9.0	37	40.4	51	20.3	56
🔔 R 1000(R) GR	23.4	30	34.9	21	11.1	18	36.3	71	21.4	46
☾ R 1000(R) VALUE	8.9	80	18.7	69	3.6	43	42.3	31	17.9	79
◆ R 2000(R)	23.4	30	19.1	68	-19.0	90	33.2	88	13.1	96
MEDIAN	17.0		27.8		2.3		40.5		20.9	

VERMONT MUNICIPAL EMPLOYEES

EQUITY ONLY LARGE FUNDS - RETURN VS RISK

3 YEARS ENDING 9/05

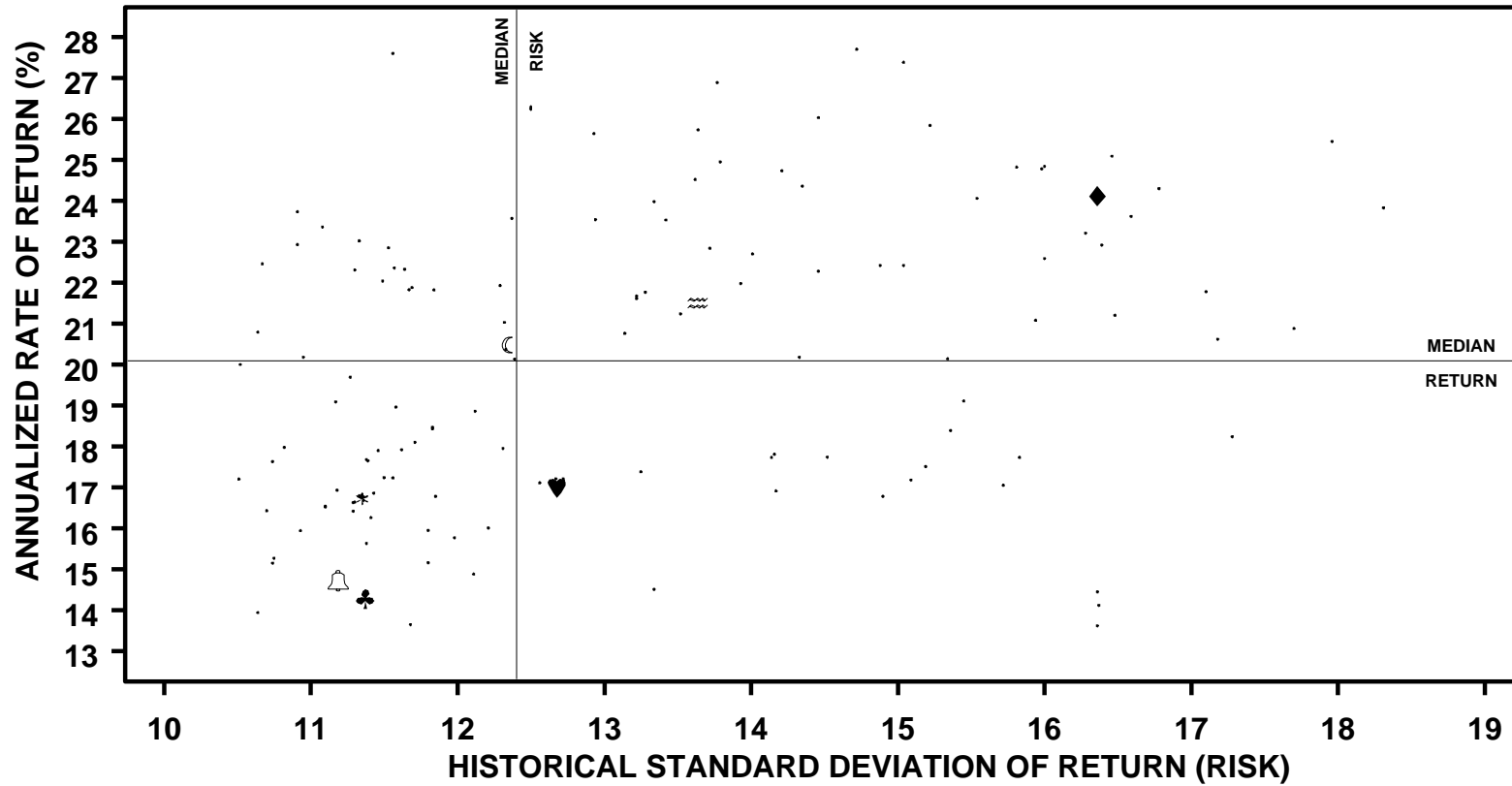

	ANNUALIZED RETURN		STANDARD DEVIATION		SHARPE RATIO	
	VALUE	RANK	VALUE	RANK	VALUE	RANK
♥ DELAWARE	17.0	71	12.7	46	1.2	73
♣ ALLIANCE	14.3	92	11.4	74	1.1	82
≍ LAZARD	21.5	41	13.6	38	1.4	39
* S&P 500	16.7	78	11.4	75	1.3	58
🔔 R 1000(R) GR	14.7	91	11.2	82	1.2	77
☾ R 1000(R) VALUE	20.5	47	12.3	50	1.5	31
◆ R 2000(R)	24.1	19	16.4	13	1.3	51
MEDIAN	20.1		12.4		1.3	

VERMONT MUNICIPAL EMPLOYEES

EQUITY ONLY LARGE FUNDS - RETURN VS RISK

5 YEARS ENDING 9/05

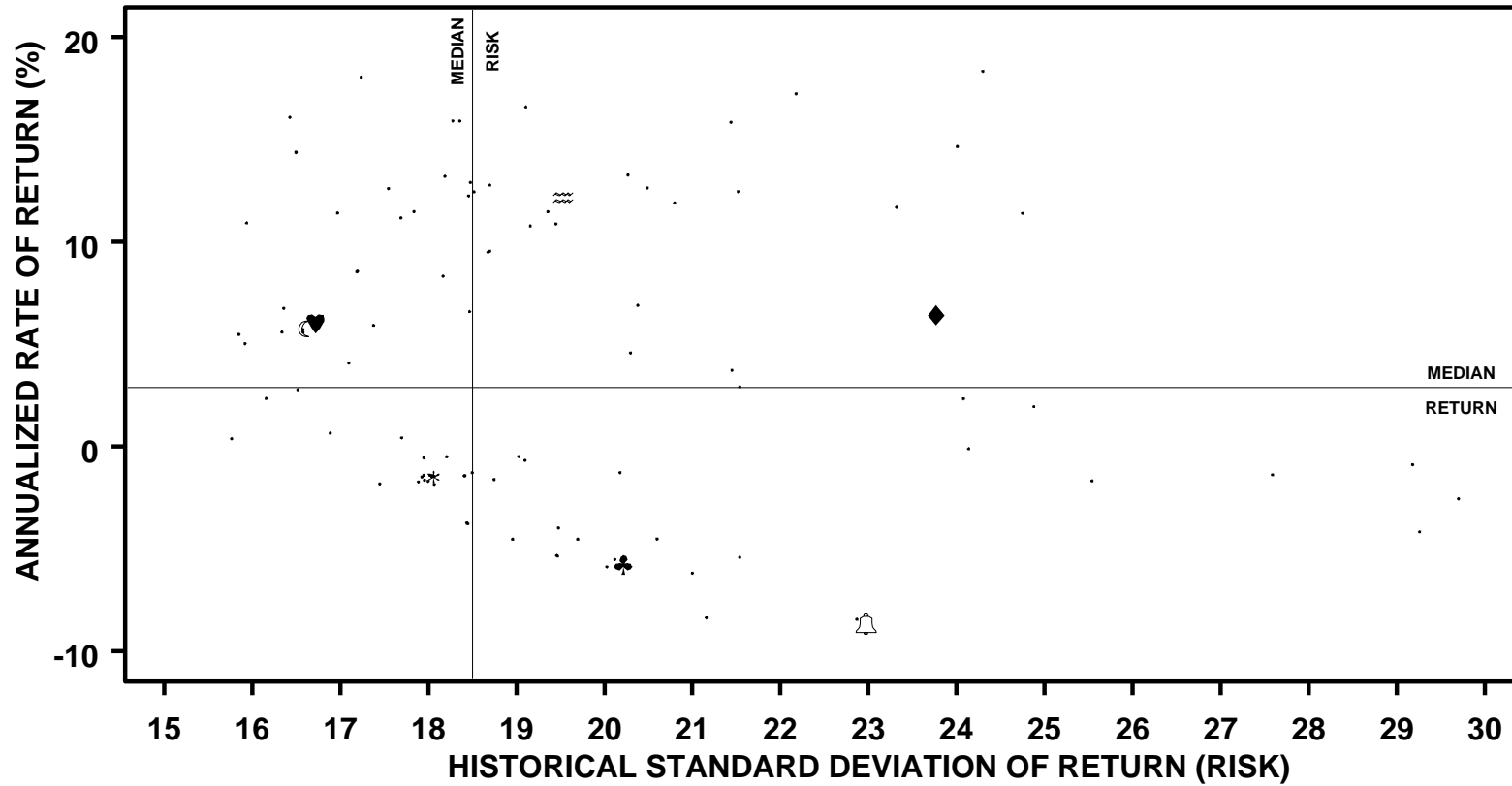

	ANNUALIZED RETURN		STANDARD DEVIATION		SHARPE RATIO	
	VALUE	RANK	VALUE	RANK	VALUE	RANK
♥ DELAWARE	6.1	42	16.7	83	0.3	41
♣ ALLIANCE	-5.8	91	20.2	31	-0.3	
≈ LAZARD	12.2	24	19.5	35	0.6	25
* S&P 500	-1.5	73	18.1	61	-0.1	
🔔 R 1000(R) GR	-8.6	95	23.0	16	-0.4	
☾ R 1000(R) VALUE	5.8	42	16.6	84	0.3	42
♦ R 2000(R)	6.4	40	23.8	14	0.3	42
MEDIAN	2.9		18.5		0.1	

VERMONT MUNICIPAL EMPLOYEES

EQUITY ONLY PUBLIC FUNDS - RATES OF RETURN

PERIODS ENDING 9/05

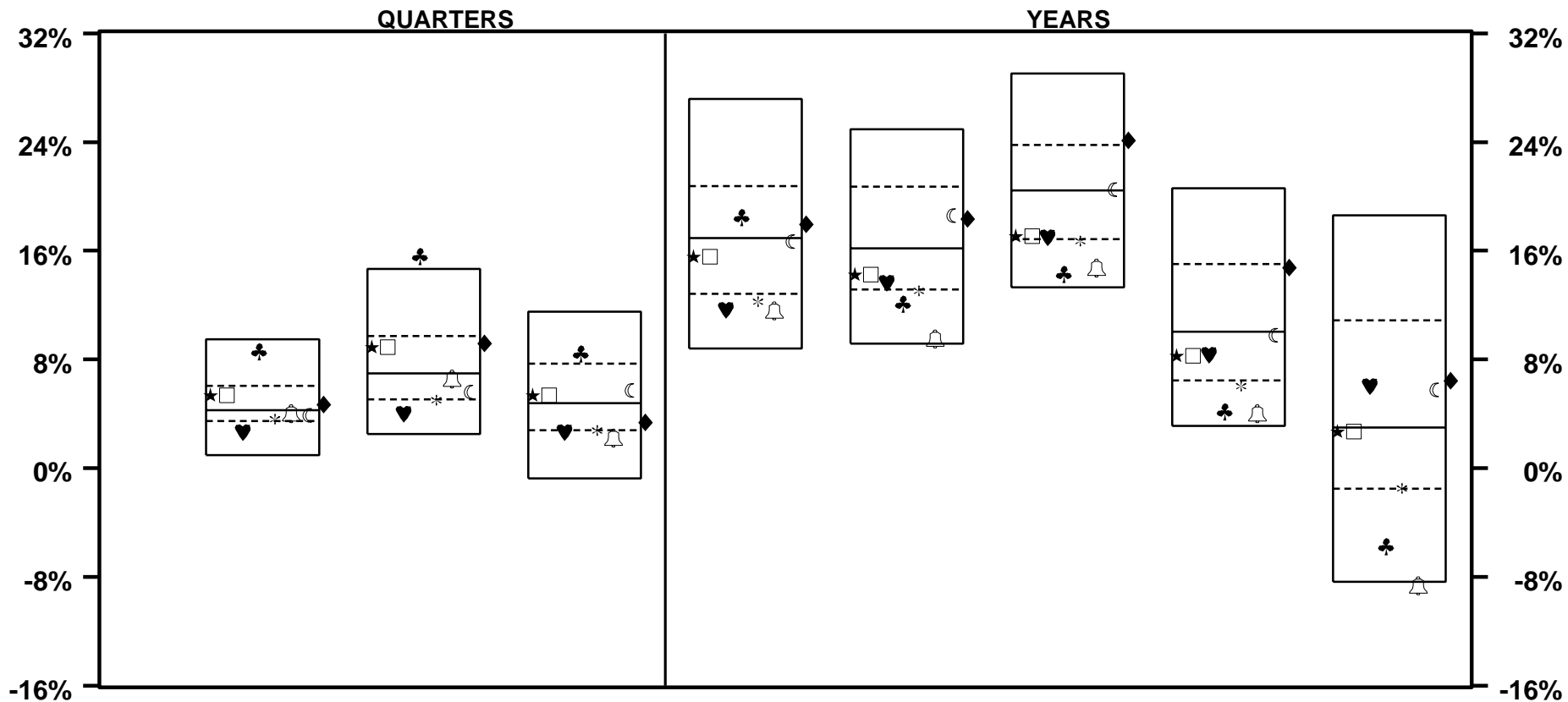

	LAST QTR		LAST 2 QTRS		LAST 3 QTRS		LAST YEAR		LAST 2 YEARS		LAST 3 YEARS		LAST 4 YEARS		LAST 5 YEARS	
★ MUNI COMPOSITE	5.4	33	8.9	31	5.4	44	15.6	59	14.2	63	17.1	73	8.3	59	2.7	51
□ EQTY COMPOSITE	5.4	33	8.9	31	5.4	44	15.6	59	14.2	63	17.1	73	8.3	59	2.7	51
♥ DELAWARE	2.7	84	4.0	87	2.7	79	11.7	86	13.7	69	17.0	73	8.4	58	6.1	38
♣ ALLIANCE	8.6	6	15.6	4	8.4	20	18.5	38	12.1	85	14.3	91	4.2	88	-5.8	90
* S&P 500	3.6	70	5.0	76	2.8	77	12.3	81	13.1	79	16.7	80	6.0	81	-1.5	73
🔔 R 1000(R) GR	4.0	56	6.6	53	2.2	82	11.6	86	9.5	94	14.7	90	4.0	91	-8.6	96
☾ R 1000(R) VALUE	3.9	60	5.6	68	5.7	41	16.7	52	18.6	34	20.5	49	9.8	50	5.8	39
◆ R 2000(R)	4.7	44	9.2	29	3.4	66	18.0	42	18.4	36	24.1	22	14.8	27	6.4	36
MEDIAN	4.3		7.0		4.8		16.9		16.2		20.4		10.0		3.0	

VERMONT MUNICIPAL EMPLOYEES

EQUITY ONLY PUBLIC FUNDS - RATES OF RETURN

PERIODS ENDING 9/05

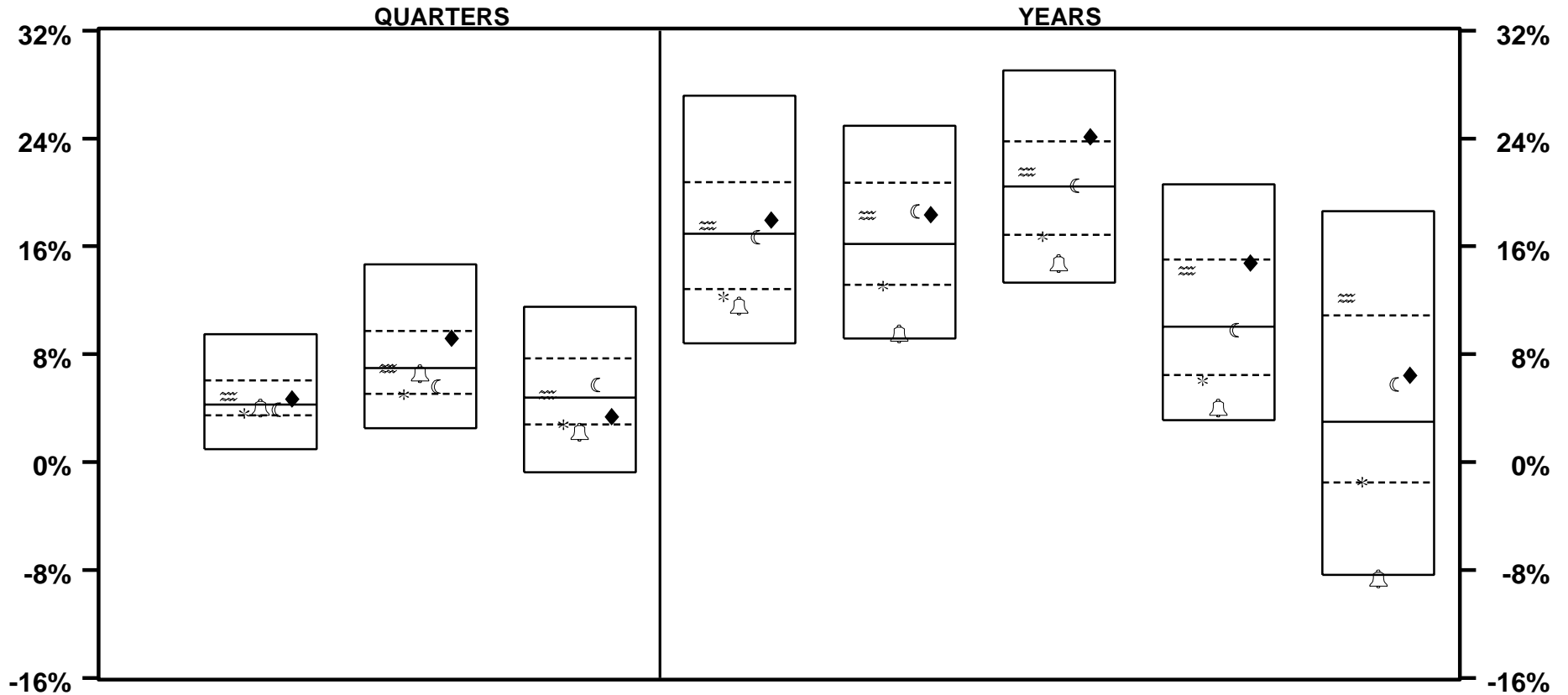

	LAST QTR		LAST 2 QTRS		LAST 3 QTRS		LAST YEAR		LAST 2 YEARS		LAST 3 YEARS		LAST 4 YEARS		LAST 5 YEARS	
≈ LAZARD	4.9	40	7.0	49	5.0	47	17.5	45	18.3	37	21.5	42	14.2	28	12.2	21
* S&P 500	3.6	70	5.0	76	2.8	77	12.3	81	13.1	79	16.7	80	6.0	81	-1.5	73
🔔 R 1000(R) GR	4.0	56	6.6	53	2.2	82	11.6	86	9.5	94	14.7	90	4.0	91	-8.6	96
☾ R 1000(R) VALUE	3.9	60	5.6	68	5.7	41	16.7	52	18.6	34	20.5	49	9.8	50	5.8	39
◆ R 2000(R)	4.7	44	9.2	29	3.4	66	18.0	42	18.4	36	24.1	22	14.8	27	6.4	36
MEDIAN	4.3		7.0		4.8		16.9		16.2		20.4		10.0		3.0	

VERMONT MUNICIPAL EMPLOYEES

EQUITY ONLY PUBLIC FUNDS - RATES OF RETURN

PERIODS ENDING 9/05

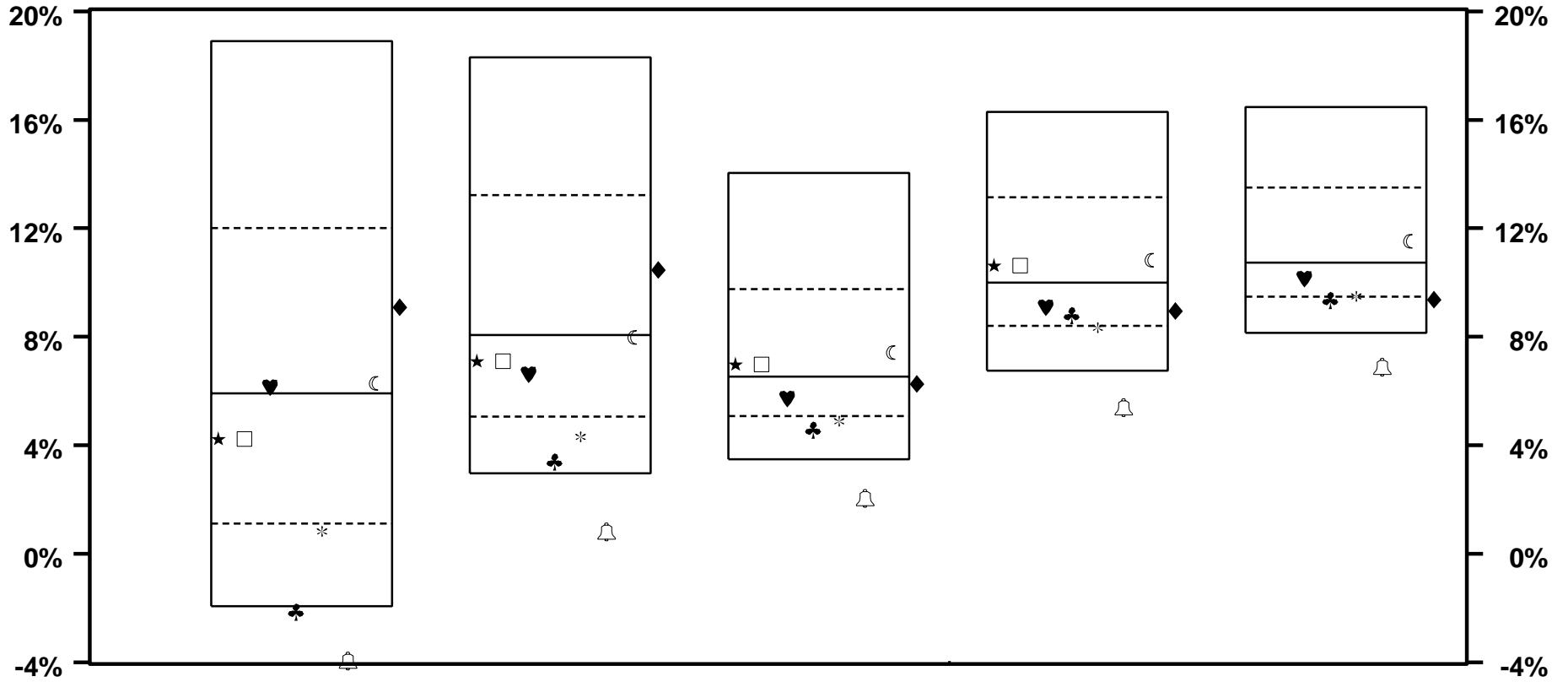

	LAST 6 YEARS		LAST 7 YEARS		LAST 8 YEARS		LAST 9 YEARS		LAST 10 YEARS	
★ MUNI COMPOSITE	4.2	61	7.1	55	7.0	45	10.6	44		
□ EQTY COMPOSITE	4.2	61	7.1	55	7.0	45	10.6	44		
♥ DELAWARE	6.1	47	6.6	59	5.7	60	9.1	60	10.1	63
♣ ALLIANCE	-2.1	95	3.4	93	4.6	85	8.8	64	9.4	78
* S&P 500	0.8	81	4.3	83	4.9	79	8.3	78	9.5	74
🔔 R 1000(R) GR	-3.9	98	0.8	100	2.1	99	5.4	100	6.9	99
☾ R 1000(R) VALUE	6.3	46	8.0	50	7.4	44	10.8	42	11.5	43
◆ R 2000(R)	9.1	32	10.5	38	6.3	51	9.0	63	9.4	77
MEDIAN	5.9		8.1		6.5		10.0		10.7	

VERMONT MUNICIPAL EMPLOYEES

EQUITY ONLY PUBLIC FUNDS - RATES OF RETURN

PERIODS ENDING 9/05

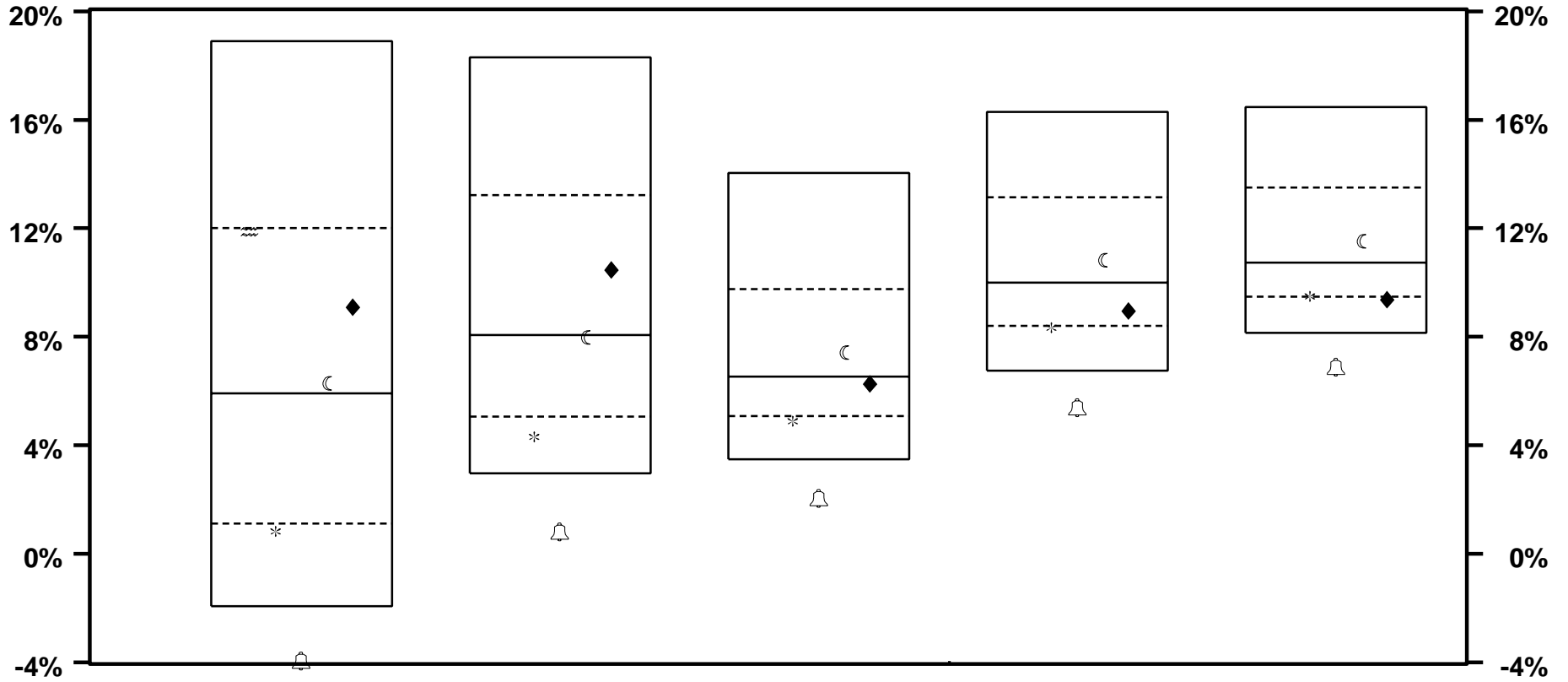

	LAST 6 YEARS		LAST 7 YEARS		LAST 8 YEARS		LAST 9 YEARS		LAST 10 YEARS	
≈ LAZARD	11.9	25								
* S&P 500	0.8	81	4.3	83	4.9	79	8.3	78	9.5	74
🔔 R 1000(R) GR	-3.9	98	0.8	100	2.1	99	5.4	100	6.9	99
☾ R 1000(R) VALUE	6.3	46	8.0	50	7.4	44	10.8	42	11.5	43
◆ R 2000(R)	9.1	32	10.5	38	6.3	51	9.0	63	9.4	77
MEDIAN	5.9		8.1		6.5		10.0		10.7	

VERMONT MUNICIPAL EMPLOYEES

EQUITY ONLY PUBLIC FUNDS - RATES OF RETURN

YEARS ENDING

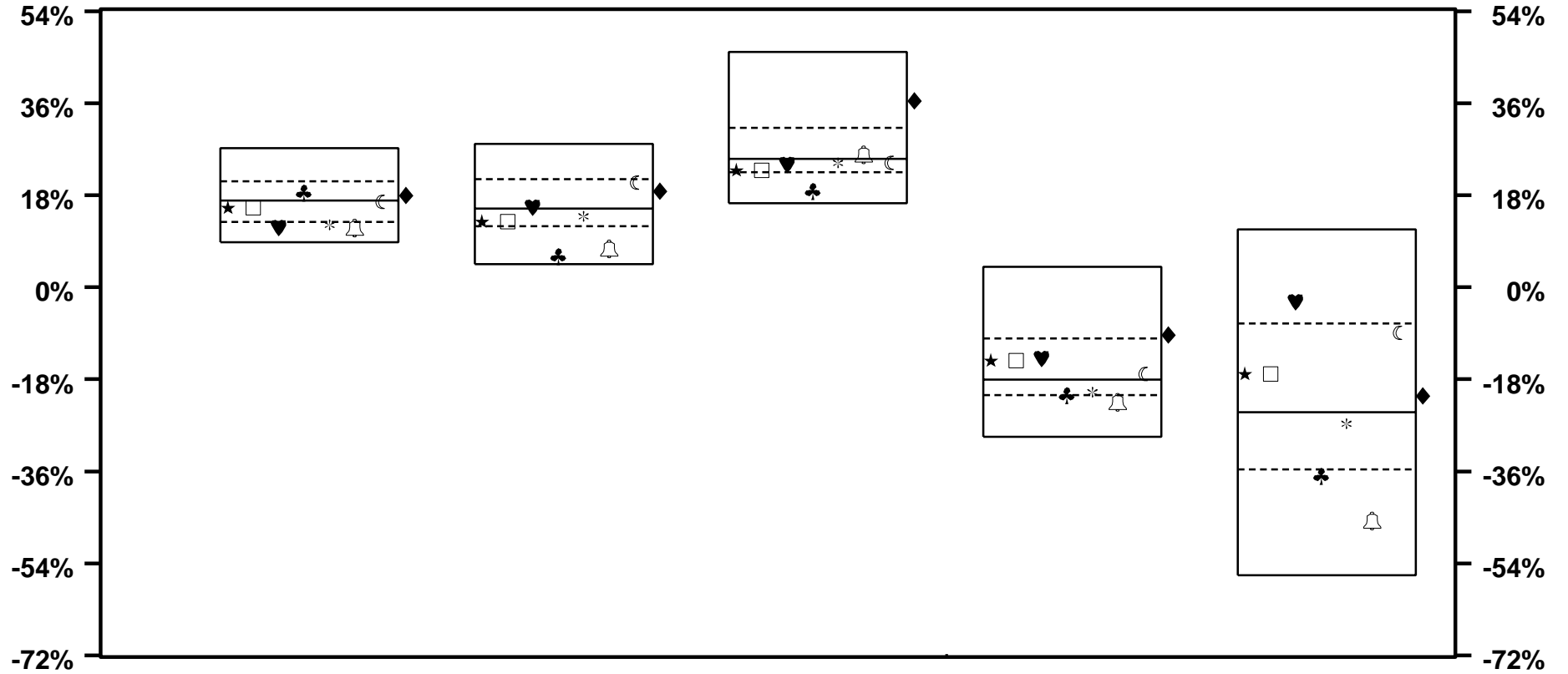

	9 / 05		9 / 04		9 / 03		9 / 02		9 / 01	
★ MUNI COMPOSITE	15.6	59	12.9	70	22.9	72	-14.3	36	-16.9	40
□ EQTY COMPOSITE	15.6	59	12.9	70	22.9	72	-14.3	36	-16.9	40
♥ DELAWARE	11.7	86	15.7	47	24.0	66	-13.9	35	-2.8	19
♣ ALLIANCE	18.5	38	6.1	92	18.8	89	-21.1	74	-36.9	76
* S&P 500	12.3	81	13.9	63	24.4	60	-20.5	68	-26.6	61
🔔 R 1000(R) GR	11.6	86	7.5	88	25.9	43	-22.5	82	-45.6	88
☾ R 1000(R) VALUE	16.7	52	20.5	27	24.4	61	-17.0	45	-8.9	28
◆ R 2000(R)	18.0	42	18.8	35	36.5	14	-9.3	23	-21.2	47
MEDIAN	16.9		15.4		25.1		-18.1		-24.5	

VERMONT MUNICIPAL EMPLOYEES

EQUITY ONLY PUBLIC FUNDS - RATES OF RETURN

YEARS ENDING

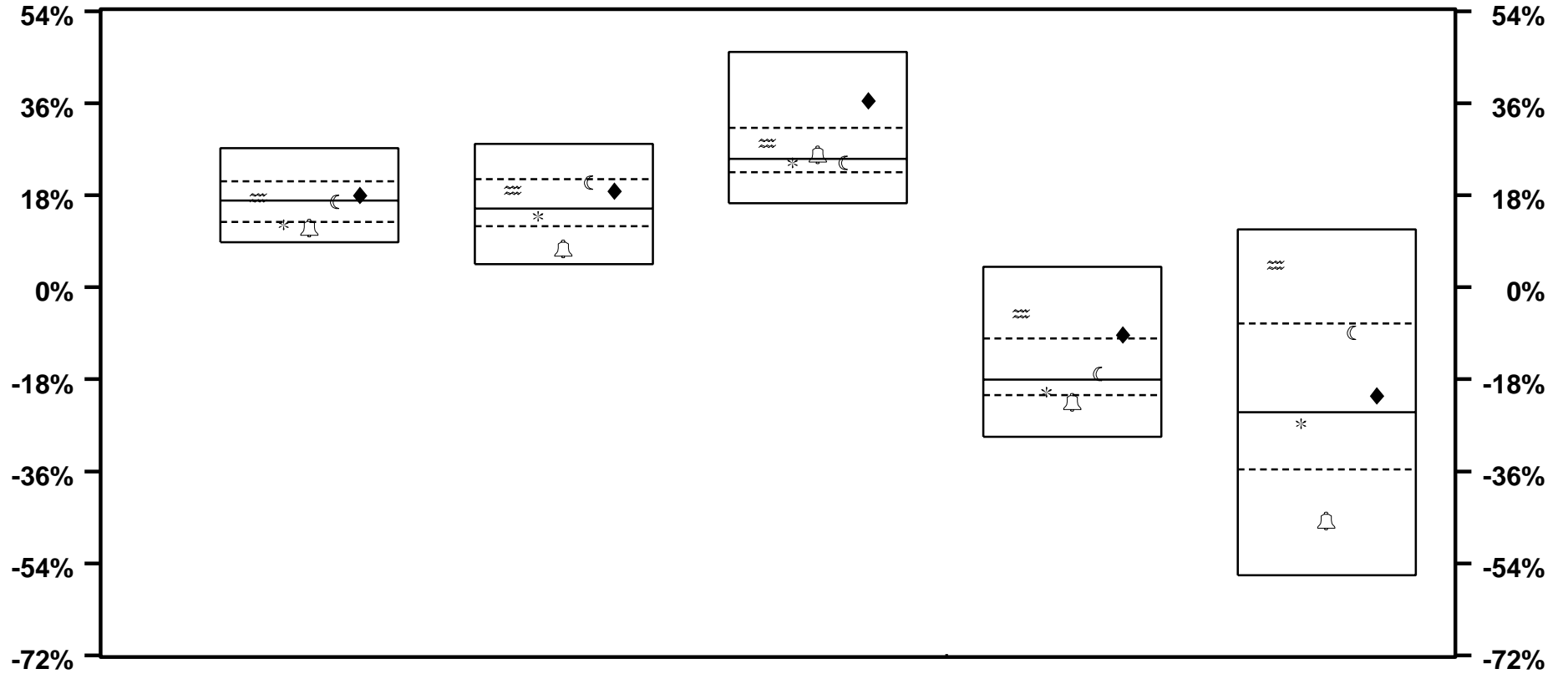

	9 / 05		9 / 04		9 / 03		9 / 02		9 / 01	
≈ LAZARD	17.5	45	19.1	33	28.2	32	-5.2	17	4.4	10
* S&P 500	12.3	81	13.9	63	24.4	60	-20.5	68	-26.6	61
🔔 R 1000(R) GR	11.6	86	7.5	88	25.9	43	-22.5	82	-45.6	88
☾ R 1000(R) VALUE	16.7	52	20.5	27	24.4	61	-17.0	45	-8.9	28
◆ R 2000(R)	18.0	42	18.8	35	36.5	14	-9.3	23	-21.2	47
MEDIAN	16.9		15.4		25.1		-18.1		-24.5	

VERMONT MUNICIPAL EMPLOYEES

EQUITY ONLY PUBLIC FUNDS - RATES OF RETURN

YEARS ENDING

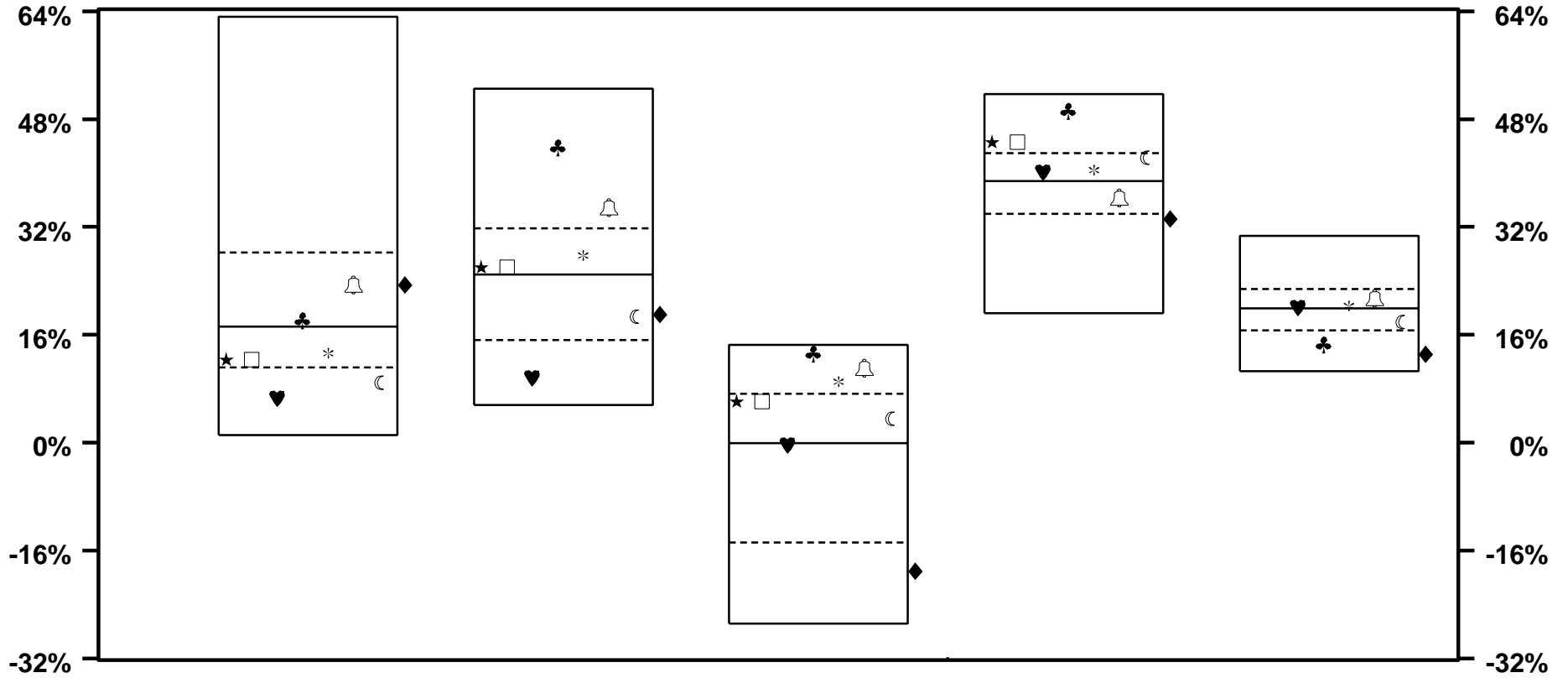

	9 / 00		9 / 99		9 / 98		9 / 97		9 / 96	
★ MUNI COMPOSITE	12.3	71	26.1	46	6.1	27	44.6	18		
□ EQTY COMPOSITE	12.3	71	26.1	46	6.1	27	44.6	18		
♥ DELAWARE	6.6	84	9.6	89	-0.3	51	40.1	43	20.1	49
♣ ALLIANCE	18.1	46	43.8	8	13.2	6	49.2	9	14.5	85
* S&P 500	13.3	65	27.8	37	9.0	19	40.4	39	20.3	45
🔔 R 1000(R) GR	23.4	34	34.9	17	11.1	10	36.3	63	21.4	33
☾ R 1000(R) VALUE	8.9	80	18.7	65	3.6	33	42.3	27	17.9	64
◆ R 2000(R)	23.4	34	19.1	64	-19.0	83	33.2	77	13.1	90
MEDIAN	17.2		24.9		-0.1		38.8		19.9	

VERMONT MUNICIPAL EMPLOYEES

EQUITY ONLY PUBLIC FUNDS - RATES OF RETURN

YEARS ENDING

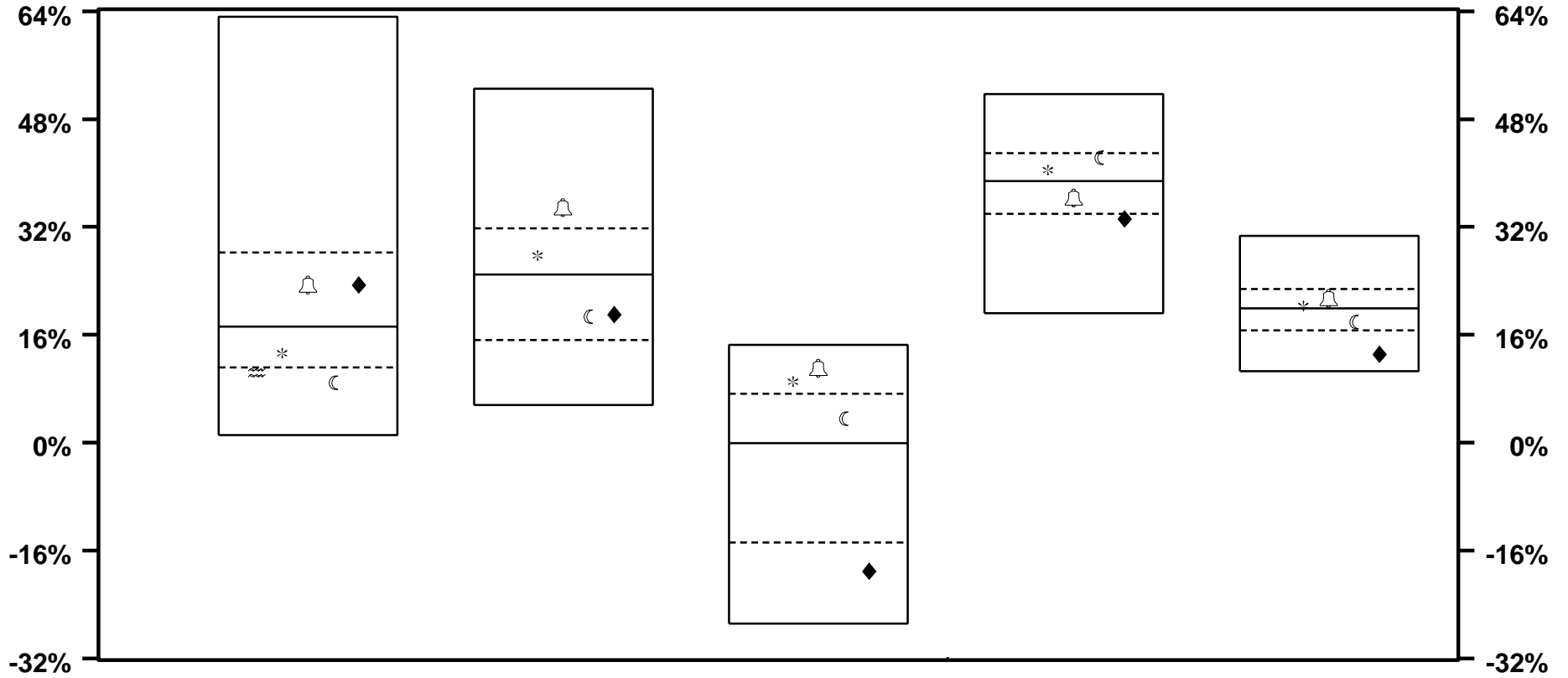

	9 / 00		9 / 99		9 / 98		9 / 97		9 / 96	
≈ LAZARD	10.4	77								
* S&P 500	13.3	65	27.8	37	9.0	19	40.4	39	20.3	45
🔔 R 1000(R) GR	23.4	34	34.9	17	11.1	10	36.3	63	21.4	33
Ⓒ R 1000(R) VALUE	8.9	80	18.7	65	3.6	33	42.3	27	17.9	64
◆ R 2000(R)	23.4	34	19.1	64	-19.0	83	33.2	77	13.1	90
MEDIAN	17.2		24.9		-0.1		38.8		19.9	

VERMONT MUNICIPAL EMPLOYEES

EQUITY ONLY PUBLIC FUNDS - RETURN VS RISK

3 YEARS ENDING 9/05

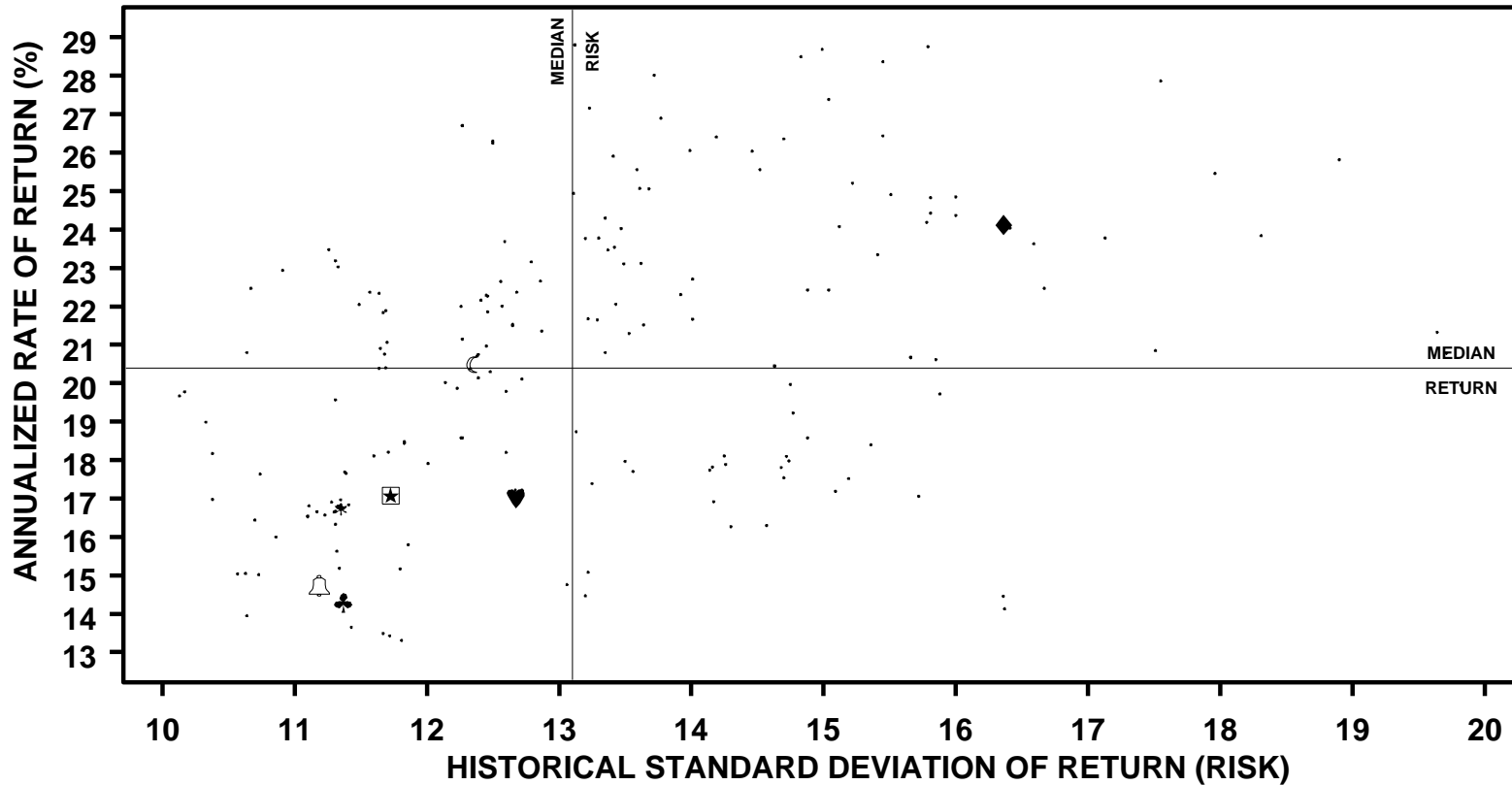

	ANNUALIZED RETURN		STANDARD DEVIATION		SHARPE RATIO	
	VALUE	RANK	VALUE	RANK	VALUE	RANK
★ MUNI COMPOSITE	17.1	73	11.7	68	1.3	64
□ EQTY COMPOSITE	17.1	73	11.7	68	1.3	64
♥ DELAWARE	17.0	73	12.7	53	1.2	73
♣ ALLIANCE	14.3	91	11.4	73	1.1	83
* S&P 500	16.7	80	11.4	75	1.3	59
🔔 R 1000(R) GR	14.7	90	11.2	82	1.2	78
☾ R 1000(R) VALUE	20.5	49	12.3	60	1.5	33
◆ R 2000(R)	24.1	22	16.4	15	1.3	52
MEDIAN	20.4		13.1		1.4	

VERMONT MUNICIPAL EMPLOYEES

EQUITY ONLY PUBLIC FUNDS - RETURN VS RISK

3 YEARS ENDING 9/05

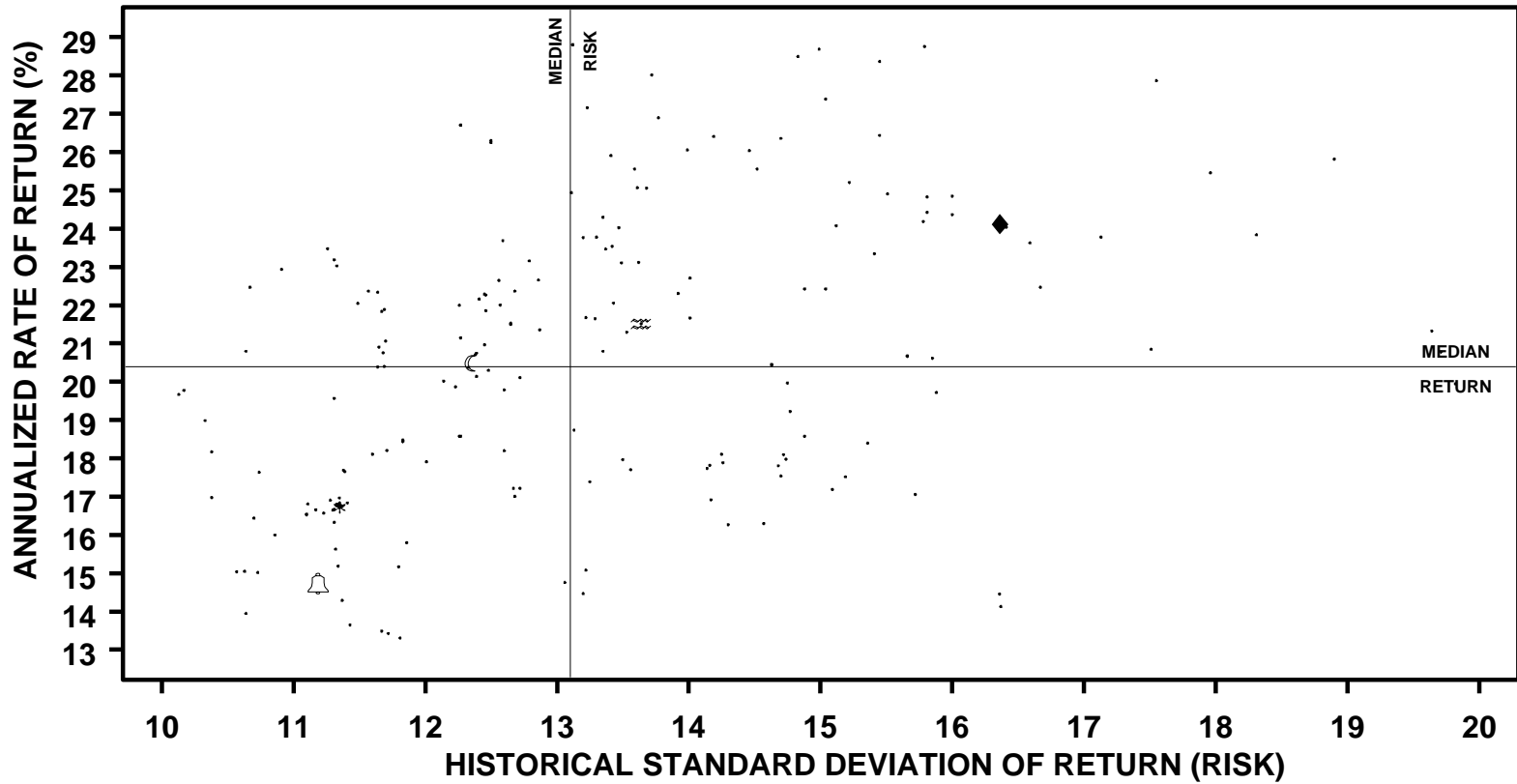

	ANNUALIZED RETURN		STANDARD DEVIATION		SHARPE RATIO	
	VALUE	RANK	VALUE	RANK	VALUE	RANK
≈ LAZARD	21.5	42	13.6	40	1.4	41
* S&P 500	16.7	80	11.4	75	1.3	59
🔔 R 1000(R) GR	14.7	90	11.2	82	1.2	78
☾ R 1000(R) VALUE	20.5	49	12.3	60	1.5	33
◆ R 2000(R)	24.1	22	16.4	15	1.3	52
MEDIAN	20.4		13.1		1.4	

VERMONT MUNICIPAL EMPLOYEES

EQUITY ONLY PUBLIC FUNDS - RETURN VS RISK

5 YEARS ENDING 9/05

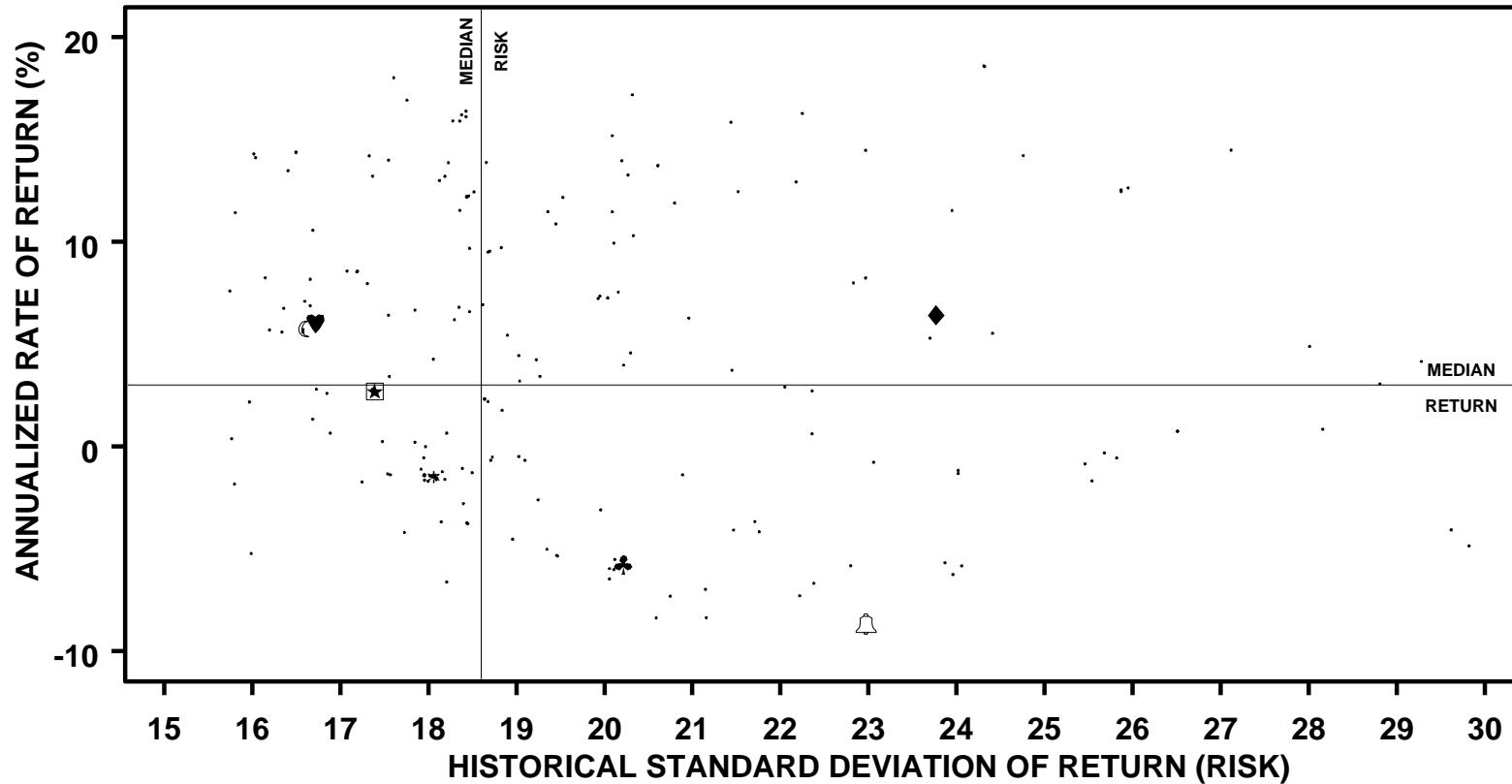

	ANNUALIZED RETURN		STANDARD DEVIATION		SHARPE RATIO	
	VALUE	RANK	VALUE	RANK	VALUE	RANK
★ MUNI COMPOSITE	2.7	51	17.4	76	0.1	51
□ EQTY COMPOSITE	2.7	51	17.4	76	0.1	51
♥ DELAWARE	6.1	38	16.7	84	0.3	38
♣ ALLIANCE	-5.8	90	20.2	34	-0.3	
* S&P 500	-1.5	73	18.1	63	-0.1	
🔔 R 1000(R) GR	-8.6	96	23.0	20	-0.4	
☾ R 1000(R) VALUE	5.8	39	16.6	86	0.3	39
◆ R 2000(R)	6.4	36	23.8	18	0.3	39
MEDIAN	3.0		18.6		0.1	

VERMONT MUNICIPAL EMPLOYEES

EQUITY ONLY PUBLIC FUNDS - RETURN VS RISK

5 YEARS ENDING 9/05

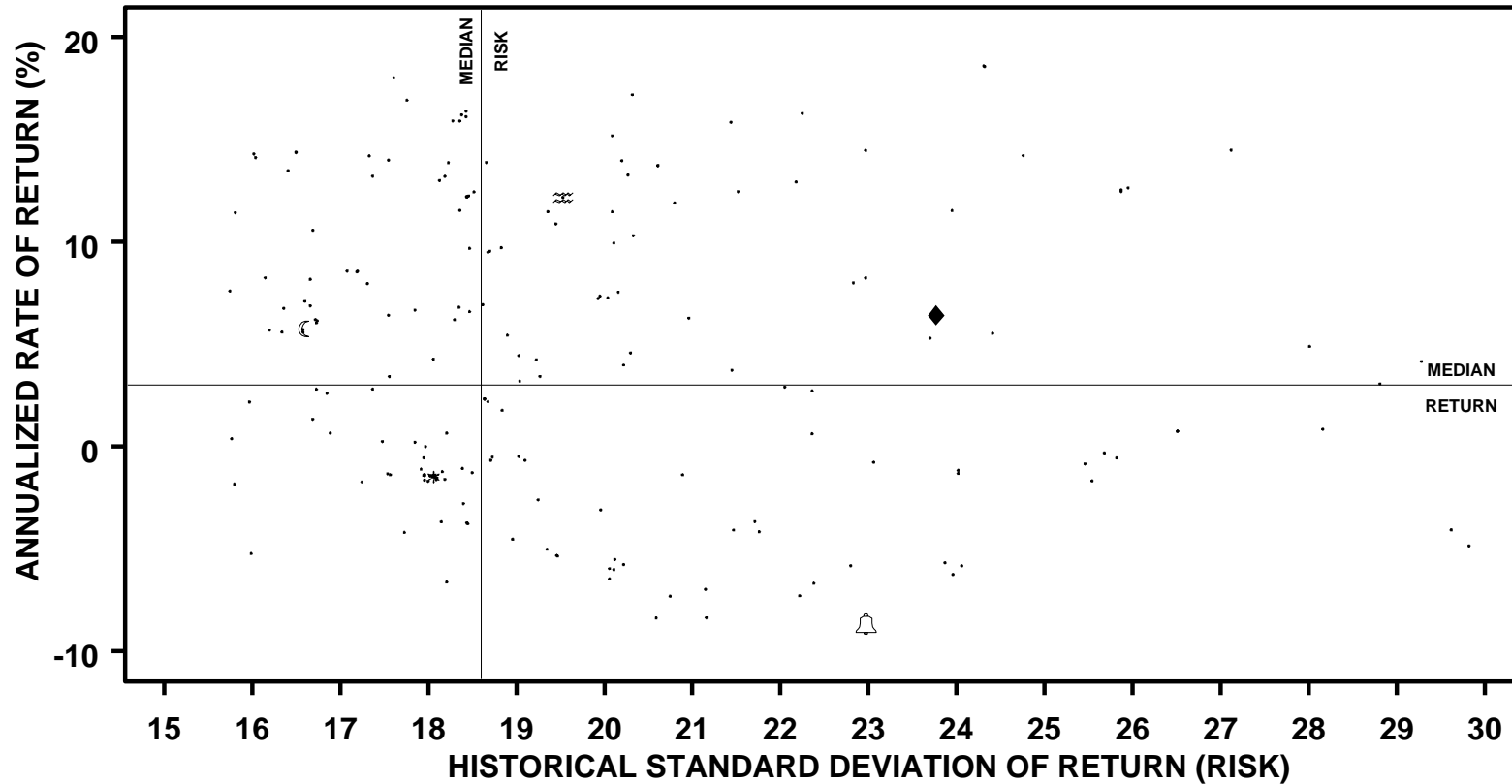

	ANNUALIZED RETURN		STANDARD DEVIATION		SHARPE RATIO	
	VALUE	RANK	VALUE	RANK	VALUE	RANK
≈ LAZARD	12.2	21	19.5	39	0.6	19
* S&P 500	-1.5	73	18.1	63	-0.1	
🔔 R 1000(R) GR	-8.6	96	23.0	20	-0.4	
☾ R 1000(R) VALUE	5.8	39	16.6	86	0.3	39
◆ R 2000(R)	6.4	36	23.8	18	0.3	39
MEDIAN	3.0		18.6		0.1	

VERMONT MUNICIPAL EMPLOYEES

BOND LARGE FUNDS - TOTAL RATES OF RETURN

PERIODS ENDING 9/05

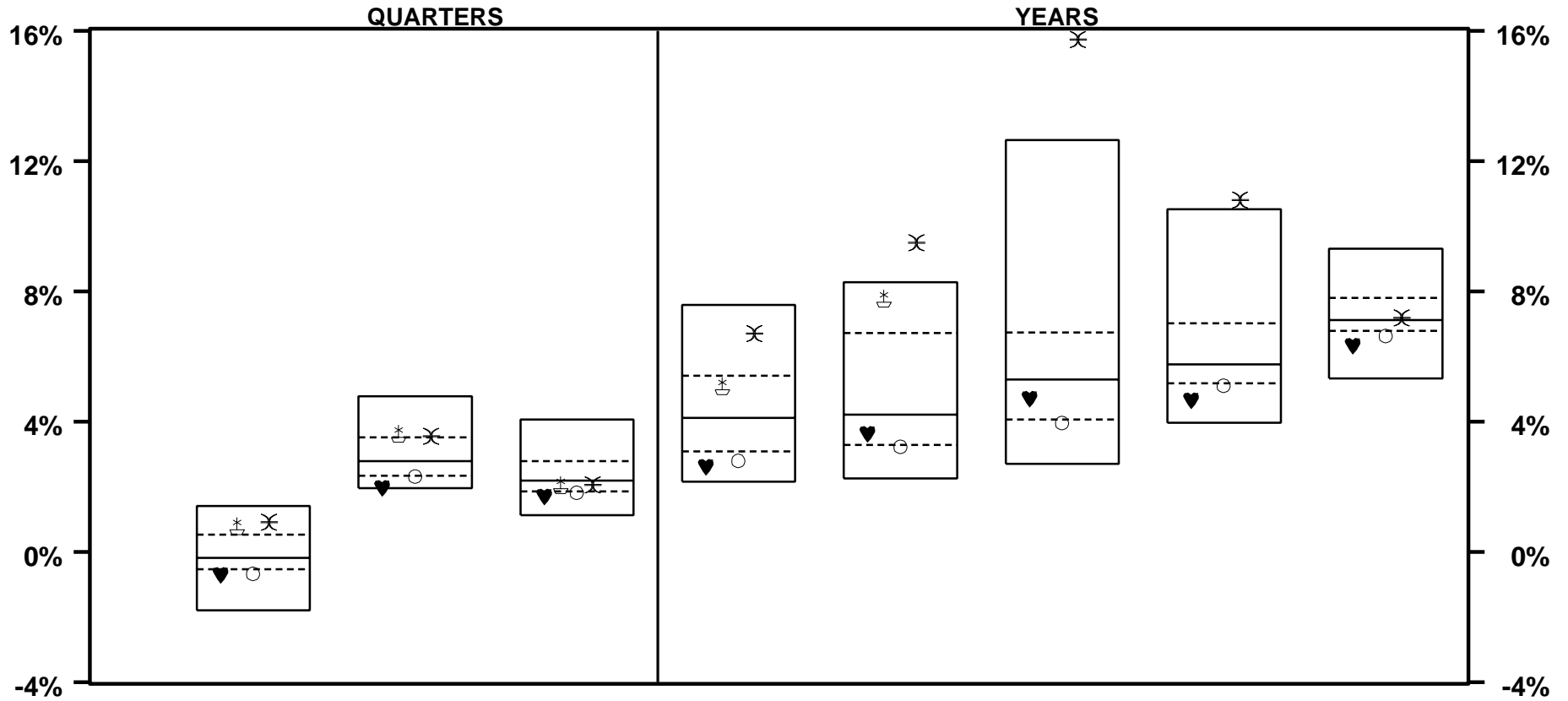

	LAST QTR		LAST 2 QTRS		LAST 3 QTRS		LAST YEAR		LAST 2 YEARS		LAST 3 YEARS		LAST 4 YEARS		LAST 5 YEARS	
♥ SEIX CORE	-0.7	86	2.0	93	1.7	85	2.6	90	3.6	63	4.7	58	4.7	90	6.3	90
⊕ SEIX HIGH YIELD	0.8	19	3.6	20	2.1	60	5.1	28	7.8	14						
○ LB AGGREGATE	-0.7	81	2.3	79	1.8	79	2.8	84	3.2	80	4.0	81	5.1	80	6.6	82
* ML HIGH YLD II	0.9	16	3.6	23	2.1	59	6.7	9	9.5	3	15.7	2	10.8	2	7.2	45
MEDIAN	-0.2		2.8		2.2		4.1		4.2		5.3		5.8		7.1	

VERMONT MUNICIPAL EMPLOYEES

BOND LARGE FUNDS - TOTAL RATES OF RETURN

YEARS ENDING

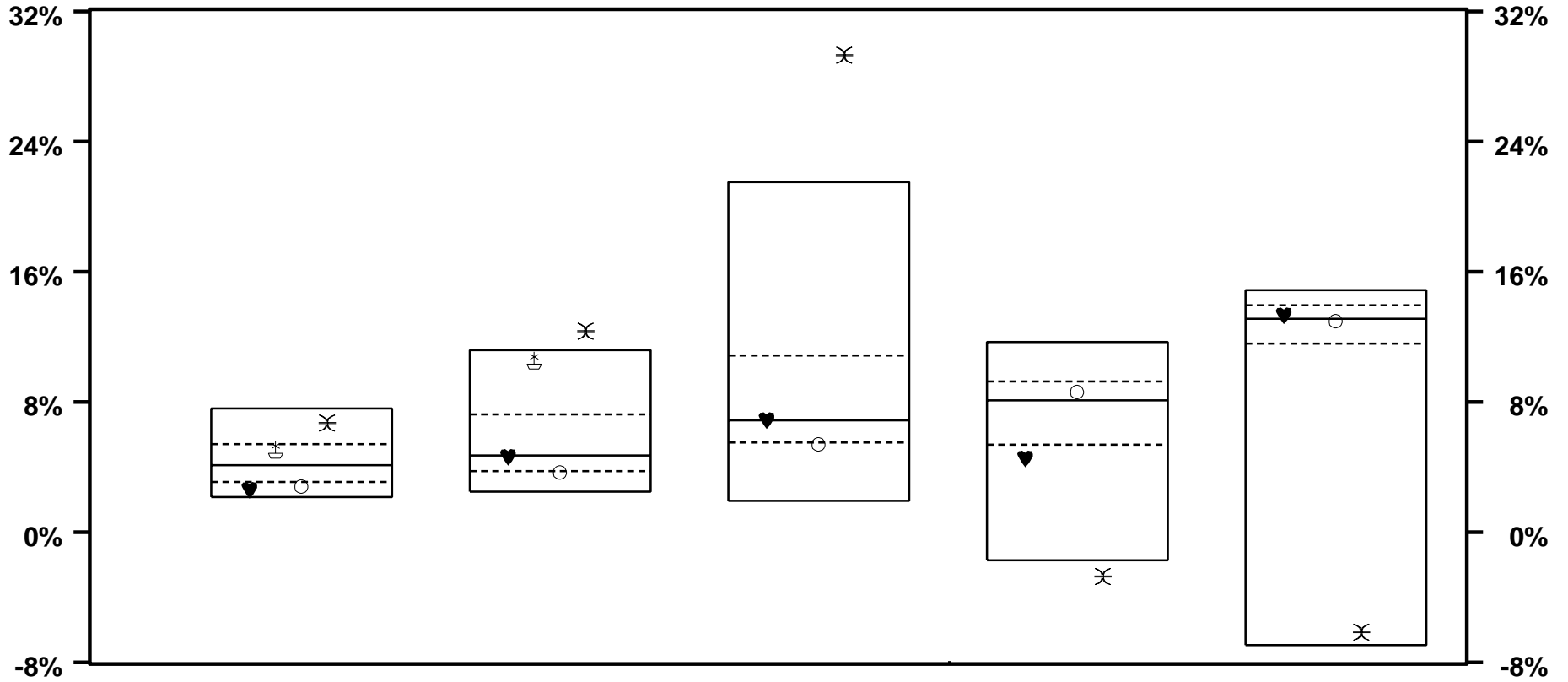

	9 / 05		9 / 04		9 / 03		9 / 02		9 / 01	
♥ SEIX CORE	2.6	90	4.6	50	6.9	49	4.5	84	13.3	46
♣ SEIX HIGH YIELD	5.1	28	10.6	12						
○ LB AGGREGATE	2.8	84	3.7	77	5.4	77	8.6	39	13.0	55
✕ ML HIGH YLD II	6.7	9	12.3	2	29.3	1	-2.7	95	-6.1	94
MEDIAN	4.1		4.7		6.9		8.1		13.1	

VERMONT MUNICIPAL EMPLOYEES

BOND LARGE FUNDS - TOTAL RETURN VS RISK

3 YEARS ENDING 9/05

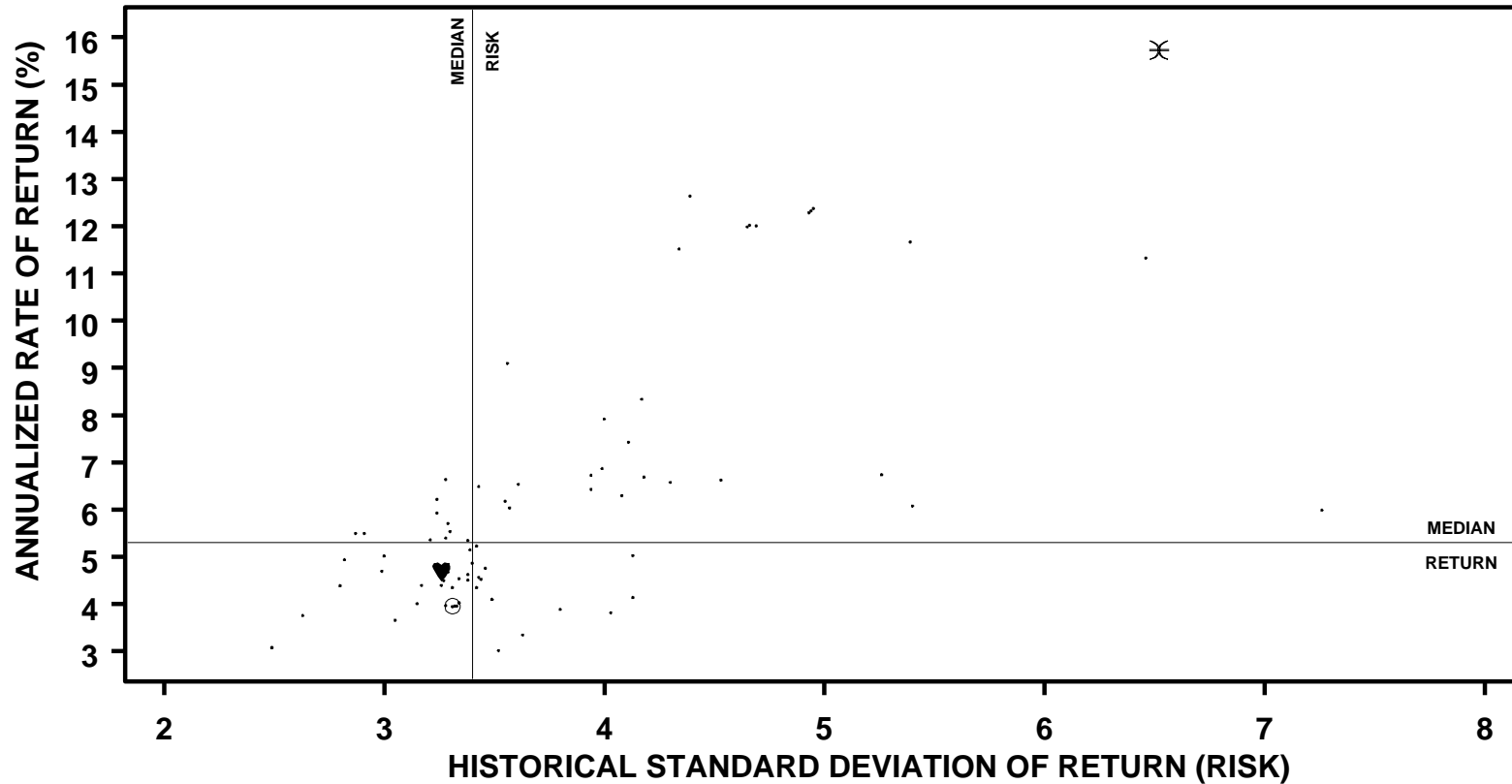

	ANNUALIZED RETURN		STANDARD DEVIATION		SHARPE RATIO	
	VALUE	RANK	VALUE	RANK	VALUE	RANK
♥ SEIX CORE	4.7	58	3.3	76	0.9	53
○ LB AGGREGATE	4.0	81	3.3	65	0.7	80
⌘ ML HIGH YLD II	15.7	2	6.5	6	2.1	9
MEDIAN	5.3		3.4		1.0	

VERMONT MUNICIPAL EMPLOYEES

BOND LARGE FUNDS - TOTAL RETURN VS RISK

5 YEARS ENDING 9/05

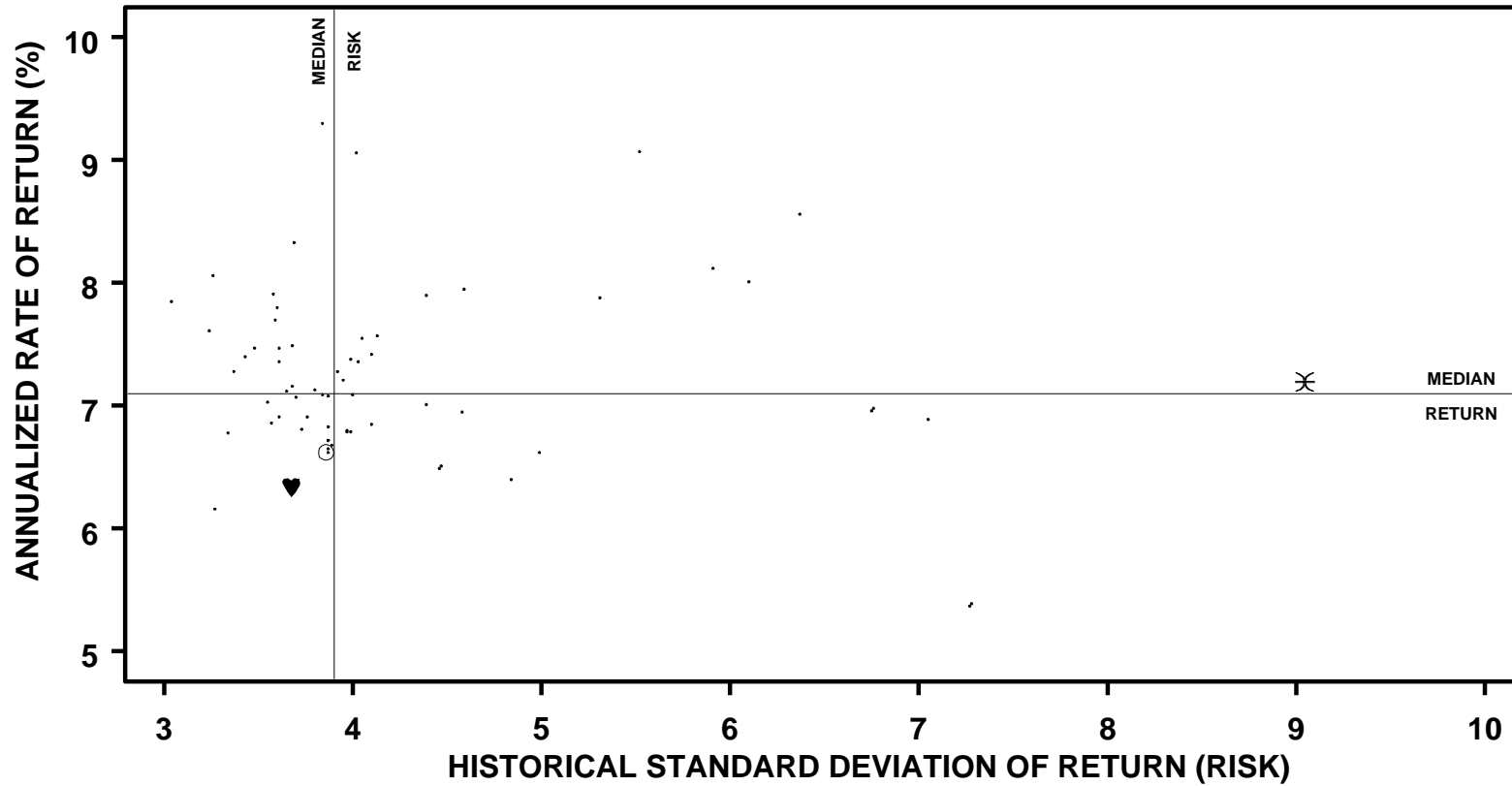

	ANNUALIZED RETURN		STANDARD DEVIATION		SHARPE RATIO	
	VALUE	RANK	VALUE	RANK	VALUE	RANK
♥ SEIX CORE	6.3	90	3.7	70	1.0	69
○ LB AGGREGATE	6.6	82	3.9	56	1.1	64
⌘ ML HIGH YLD II	7.2	45	9.0	2	0.5	94
MEDIAN	7.1		3.9		1.2	

VERMONT MUNICIPAL EMPLOYEES

BOND PUBLIC FUNDS - TOTAL RATES OF RETURN

PERIODS ENDING 9/05

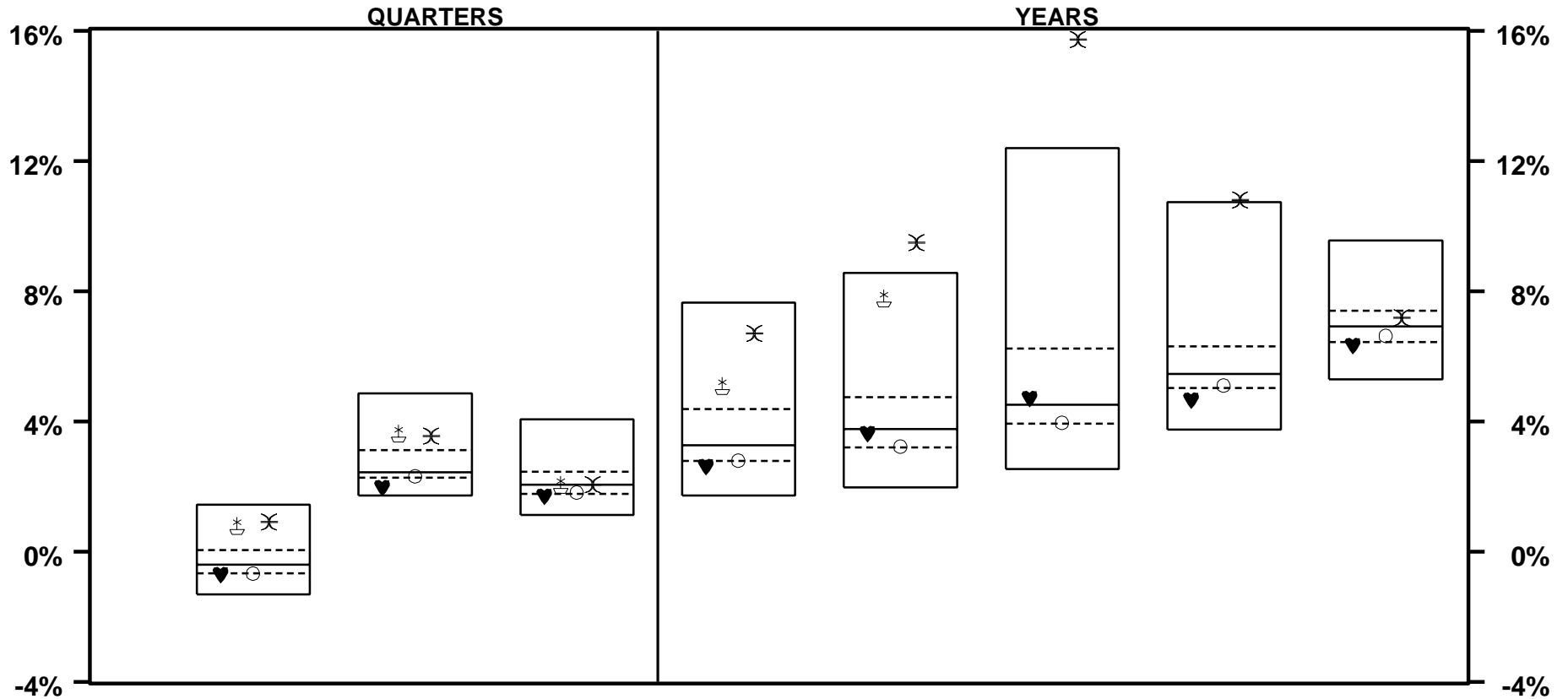

	LAST QTR		LAST 2 QTRS		LAST 3 QTRS		LAST YEAR		LAST 2 YEARS		LAST 3 YEARS		LAST 4 YEARS		LAST 5 YEARS	
♥ SEIX CORE	-0.7	82	2.0	89	1.7	77	2.6	83	3.6	53	4.7	44	4.7	82	6.3	76
⊠ SEIX HIGH YIELD	0.8	15	3.6	10	2.1	49	5.1	16	7.8	10						
○ LB AGGREGATE	-0.7	76	2.3	68	1.8	69	2.8	74	3.2	71	4.0	71	5.1	69	6.6	67
⊗ ML HIGH YLD II	0.9	10	3.6	11	2.1	48	6.7	7	9.5	3	15.7	2	10.8	4	7.2	32
MEDIAN	-0.4		2.4		2.0		3.3		3.8		4.5		5.5		6.9	

VERMONT MUNICIPAL EMPLOYEES

BOND PUBLIC FUNDS - TOTAL RATES OF RETURN

YEARS ENDING

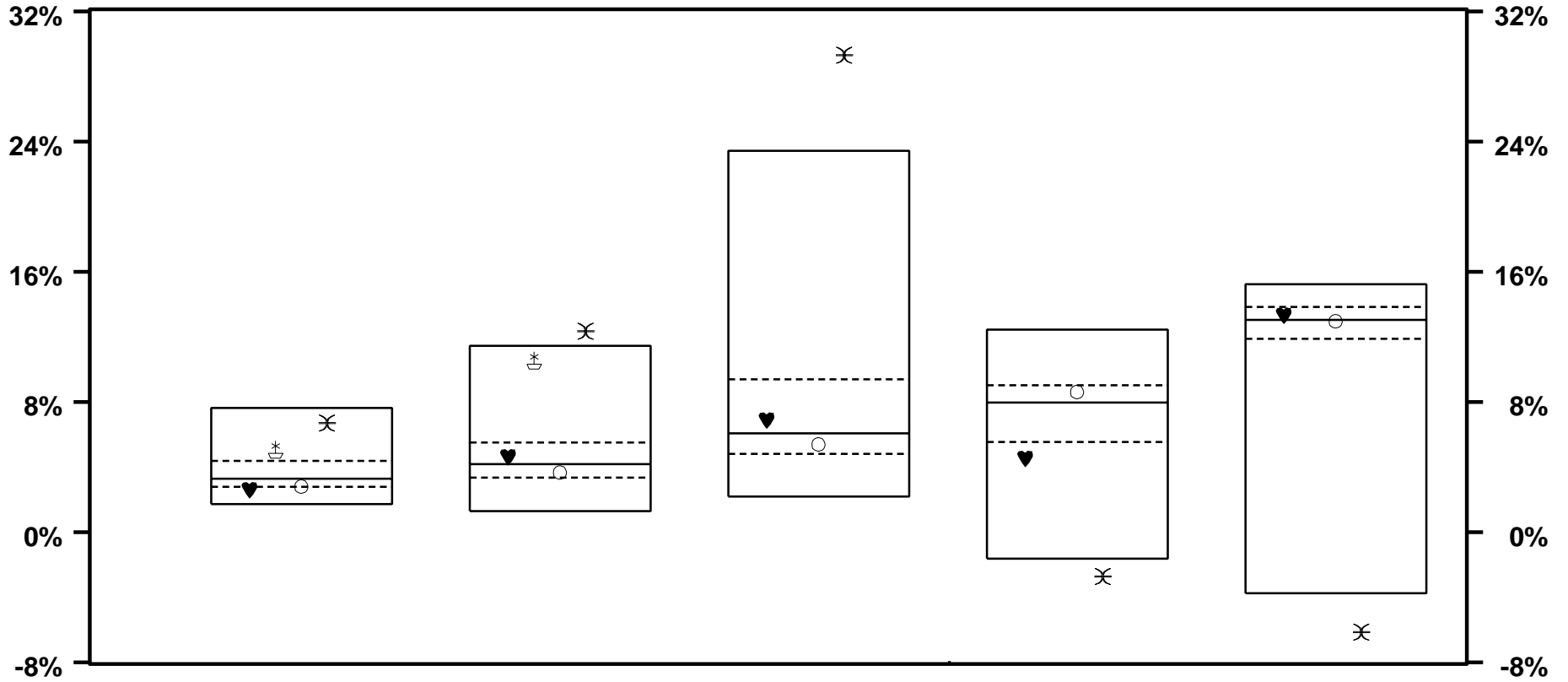

	9 / 05		9 / 04		9 / 03		9 / 02		9 / 01	
♥ SEIX CORE	2.6	83	4.6	36	6.9	36	4.5	79	13.3	40
⊠ SEIX HIGH YIELD	5.1	16	10.6	10						
○ LB AGGREGATE	2.8	74	3.7	66	5.4	64	8.6	34	13.0	53
✕ ML HIGH YLD II	6.7	7	12.3	4	29.3	2	-2.7	95	-6.1	96
MEDIAN	3.3		4.2		6.1		8.0		13.0	

VERMONT MUNICIPAL EMPLOYEES

BOND PUBLIC FUNDS - TOTAL RETURN VS RISK

3 YEARS ENDING 9/05

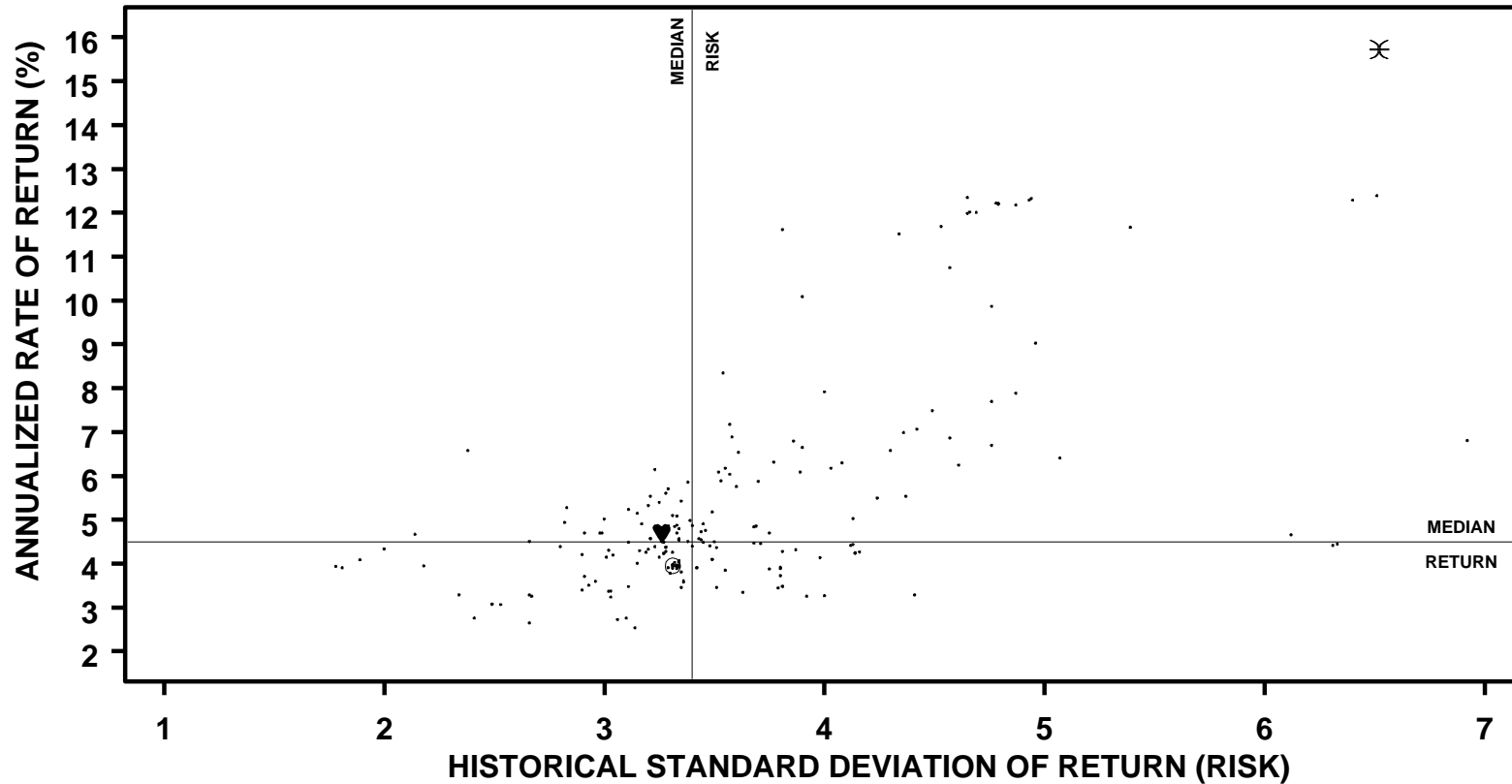

	ANNUALIZED RETURN		STANDARD DEVIATION		SHARPE RATIO	
	VALUE	RANK	VALUE	RANK	VALUE	RANK
♥ SEIX CORE	4.7	44	3.3	67	0.9	44
○ LB AGGREGATE	4.0	71	3.3	60	0.7	68
⊗ ML HIGH YLD II	15.7	2	6.5	6	2.1	8
MEDIAN	4.5		3.4		0.8	

VERMONT MUNICIPAL EMPLOYEES

BOND PUBLIC FUNDS - TOTAL RETURN VS RISK

5 YEARS ENDING 9/05

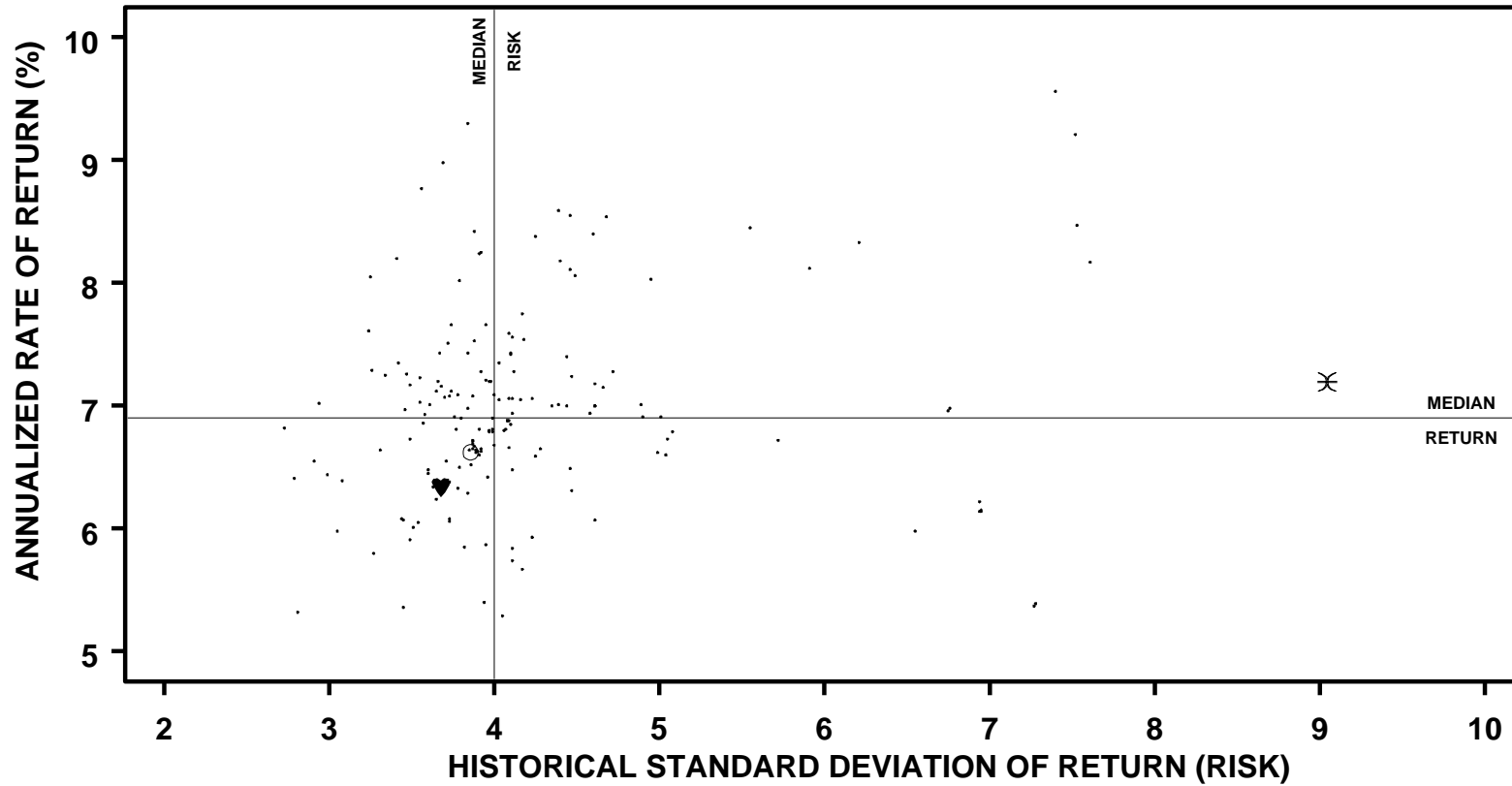

	ANNUALIZED RETURN		STANDARD DEVIATION		SHARPE RATIO	
	VALUE	RANK	VALUE	RANK	VALUE	RANK
♥ SEIX CORE	6.3	76	3.7	75	1.0	58
○ LB AGGREGATE	6.6	67	3.9	61	1.1	50
⌘ ML HIGH YLD II	7.2	32	9.0	2	0.5	94
MEDIAN	6.9		4.0		1.1	

VERMONT MUNICIPAL EMPLOYEES

BOND ONLY LARGE FUNDS - RATES OF RETURN

PERIODS ENDING 9/05

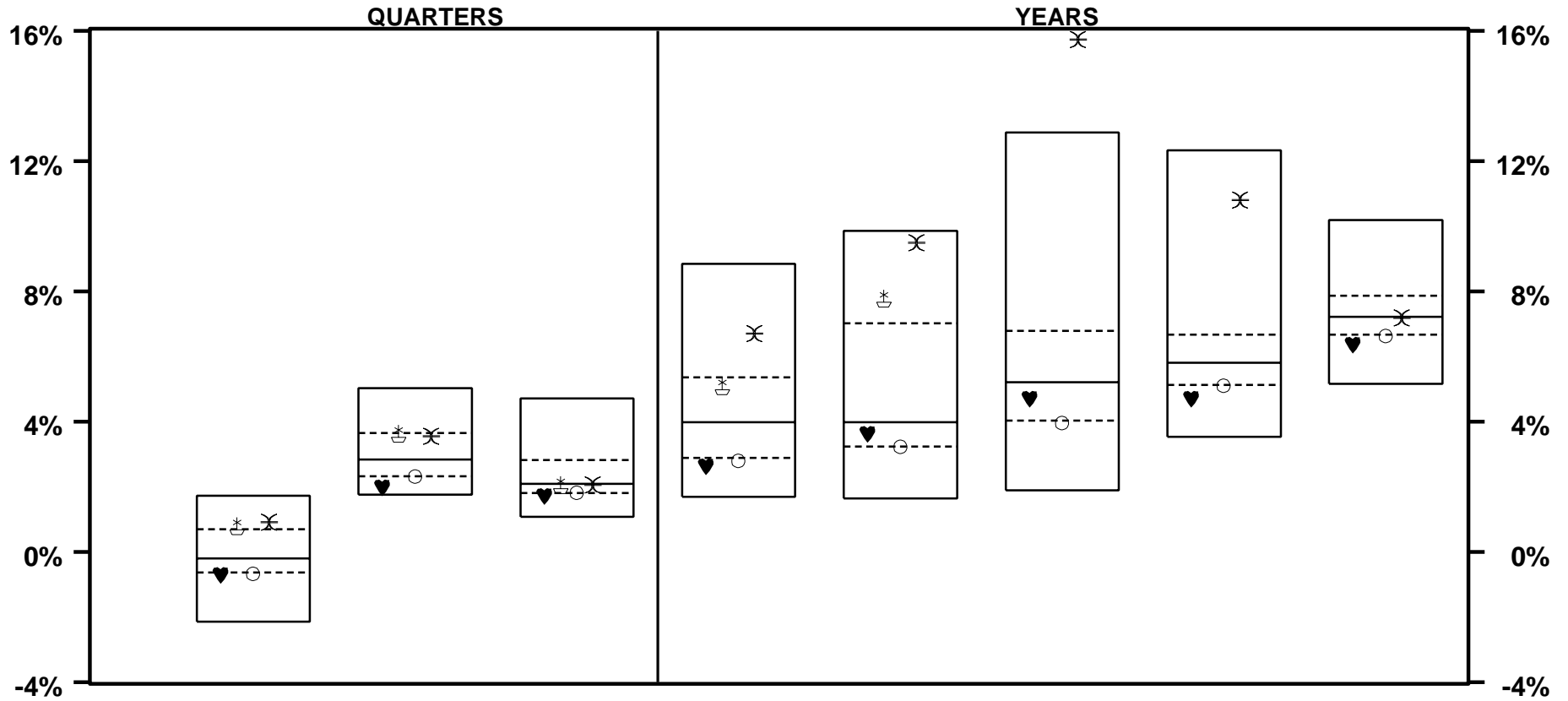

	LAST QTR		LAST 2 QTRS		LAST 3 QTRS		LAST YEAR		LAST 2 YEARS		LAST 3 YEARS		LAST 4 YEARS		LAST 5 YEARS	
♥ SEIX CORE	-0.7	82	2.0	91	1.7	77	2.6	84	3.6	58	4.7	58	4.7	85	6.4	84
⊕ SEIX HIGH YIELD	0.8	20	3.6	25	2.1	52	5.1	27	7.8	22						
○ LB AGGREGATE	-0.7	77	2.3	77	1.8	71	2.8	79	3.2	75	4.0	79	5.1	78	6.6	77
* ML HIGH YLD II	0.9	18	3.6	28	2.1	51	6.7	10	9.5	6	15.7	2	10.8	10	7.2	52
MEDIAN	-0.2		2.8		2.1		4.0		4.0		5.2		5.8		7.2	

VERMONT MUNICIPAL EMPLOYEES

BOND ONLY LARGE FUNDS - RATES OF RETURN

YEARS ENDING

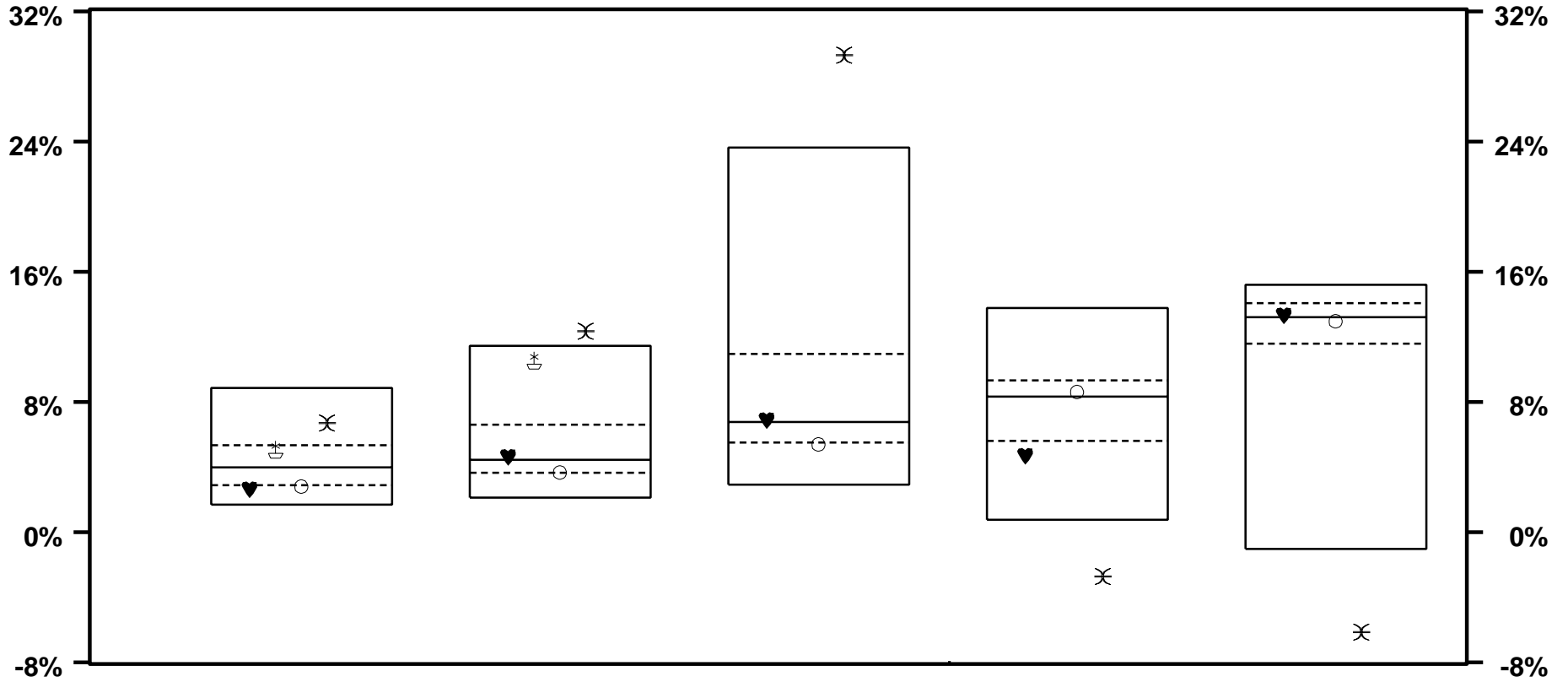

	9 / 05		9 / 04		9 / 03		9 / 02		9 / 01	
♥ SEIX CORE	2.6	84	4.6	47	6.9	48	4.7	82	13.3	47
⊠ SEIX HIGH YIELD	5.1	27	10.6	15						
○ LB AGGREGATE	2.8	79	3.7	74	5.4	77	8.6	40	13.0	58
⌘ ML HIGH YLD II	6.7	10	12.3	1	29.3	2	-2.7	99	-6.1	97
MEDIAN	4.0		4.5		6.8		8.3		13.2	

VERMONT MUNICIPAL EMPLOYEES

BOND ONLY LARGE FUNDS - RETURN VS RISK

3 YEARS ENDING 9/05

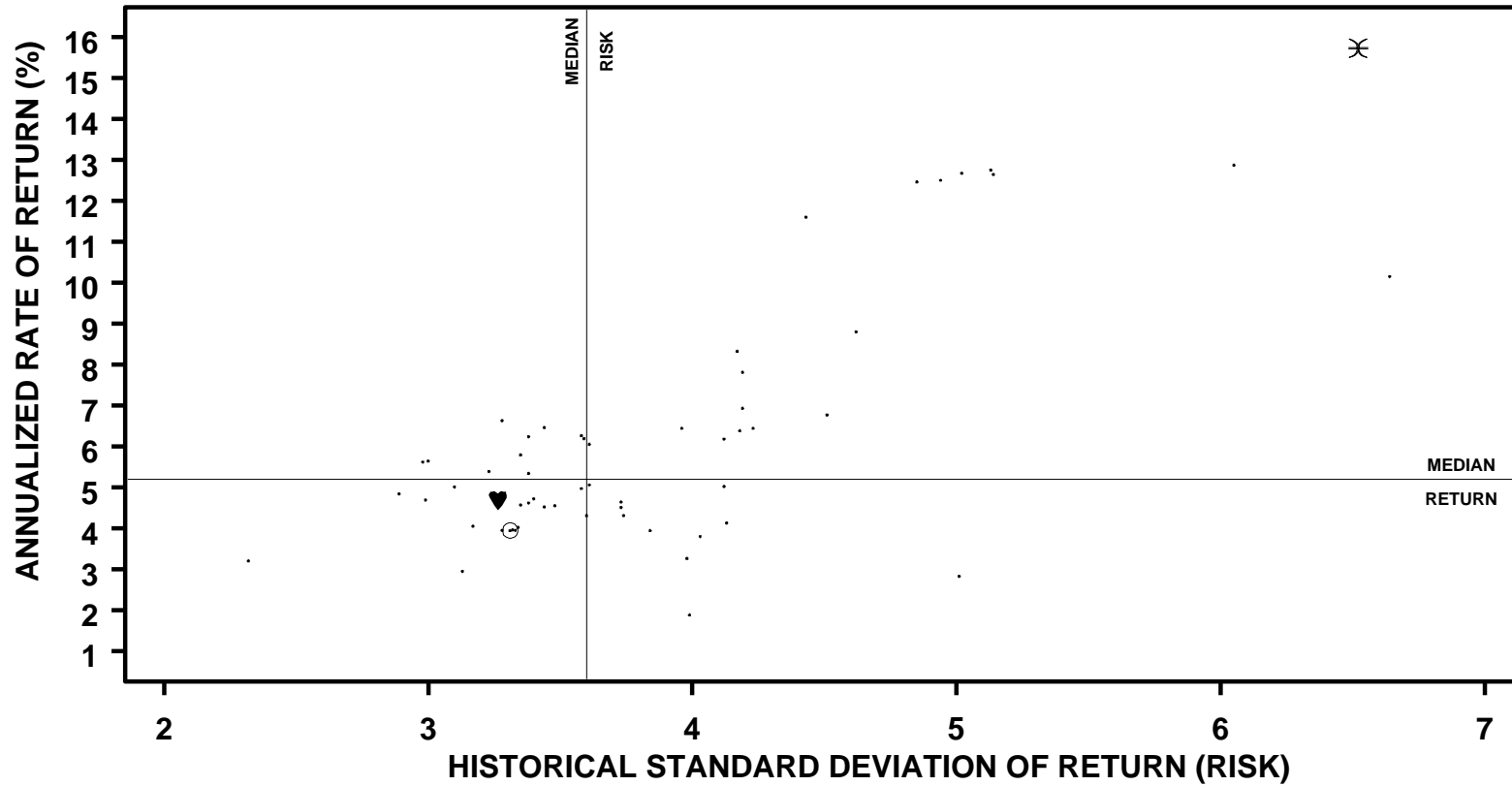

	ANNUALIZED RETURN		STANDARD DEVIATION		SHARPE RATIO	
	VALUE	RANK	VALUE	RANK	VALUE	RANK
♥ SEIX CORE	4.7	58	3.3	80	0.9	50
○ LB AGGREGATE	4.0	79	3.3	77	0.7	74
⊗ ML HIGH YLD II	15.7	2	6.5	8	2.1	9
MEDIAN	5.2		3.6		0.9	

VERMONT MUNICIPAL EMPLOYEES

BOND ONLY LARGE FUNDS - RETURN VS RISK

5 YEARS ENDING 9/05

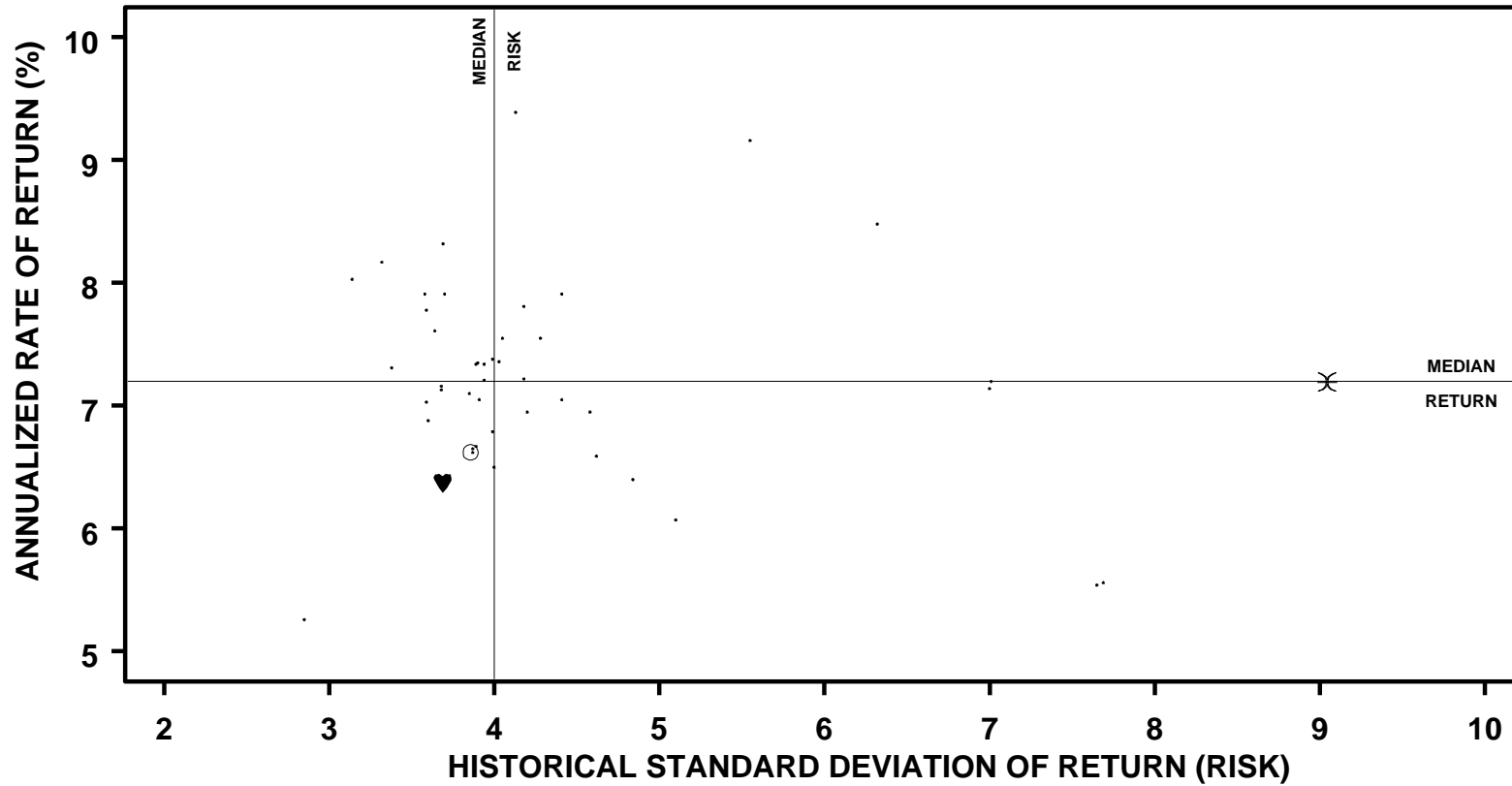

	ANNUALIZED RETURN		STANDARD DEVIATION		SHARPE RATIO	
	VALUE	RANK	VALUE	RANK	VALUE	RANK
♥ SEIX CORE	6.4	84	3.7	73	1.0	64
○ LB AGGREGATE	6.6	77	3.9	68	1.1	58
⊗ ML HIGH YLD II	7.2	52	9.0	2	0.5	91
MEDIAN	7.2		4.0		1.2	

VERMONT MUNICIPAL EMPLOYEES

BOND ONLY PUBLIC FUNDS - RATES OF RETURN

PERIODS ENDING 9/05

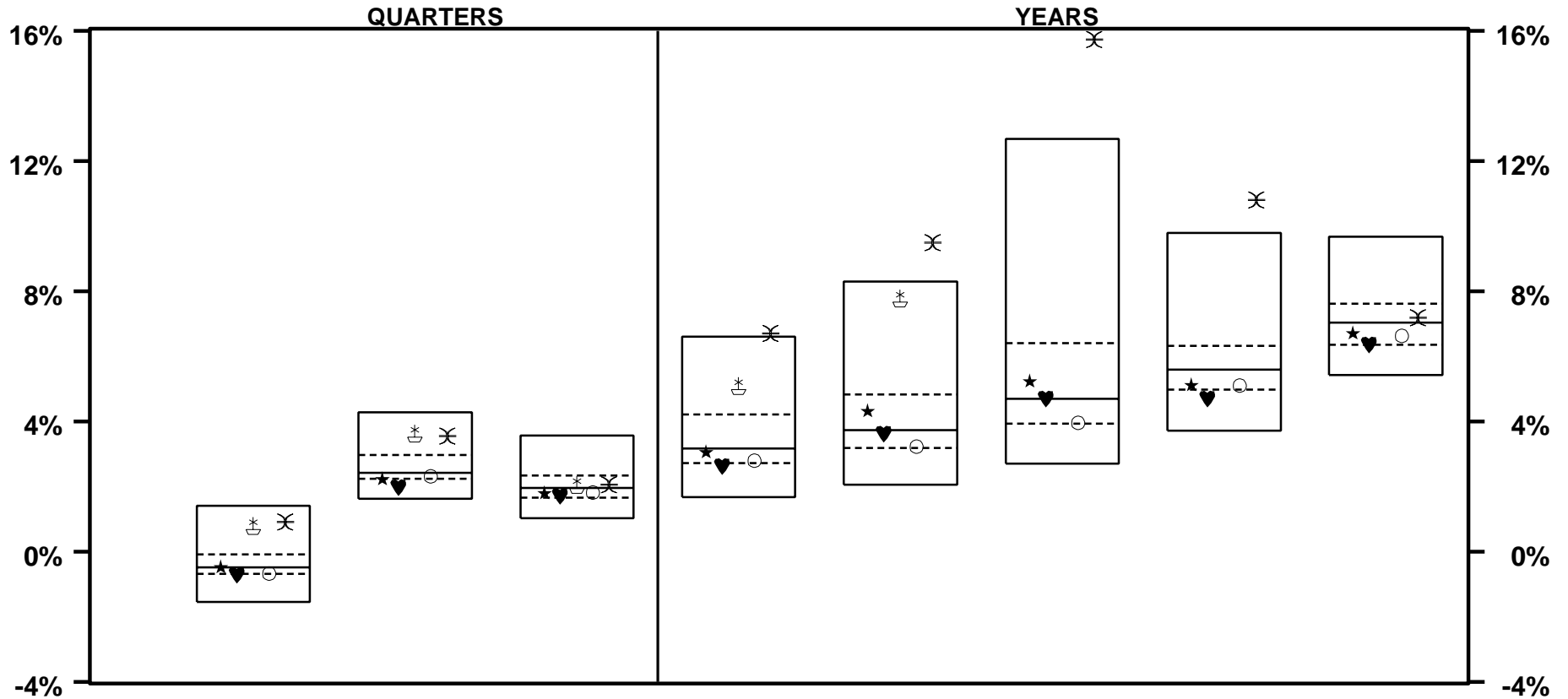

	LAST QTR		LAST 2 QTRS		LAST 3 QTRS		LAST YEAR		LAST 2 YEARS		LAST 3 YEARS		LAST 4 YEARS		LAST 5 YEARS	
★ MUNI COMPOSITE	- 0.5	49	2.2	76	1.8	63	3.1	55	4.3	32	5.2	35	5.1	68	6.7	61
♥ SEIX CORE	- 0.7	75	2.0	88	1.7	70	2.6	79	3.6	53	4.7	48	4.7	80	6.4	74
⊠ SEIX HIGH YIELD	0.8	12	3.6	10	2.1	42	5.1	14	7.8	9						
○ LB AGGREGATE	- 0.7	69	2.3	64	1.8	61	2.8	69	3.2	71	4.0	72	5.1	71	6.6	67
✕ ML HIGH YLD II	0.9	8	3.6	11	2.1	41	6.7	4	9.5	1	15.7	1	10.8	2	7.2	39
MEDIAN	- 0.5		2.4		1.9		3.2		3.7		4.7		5.6		7.0	

VERMONT MUNICIPAL EMPLOYEES

BOND ONLY PUBLIC FUNDS - RATES OF RETURN

PERIODS ENDING 9/05

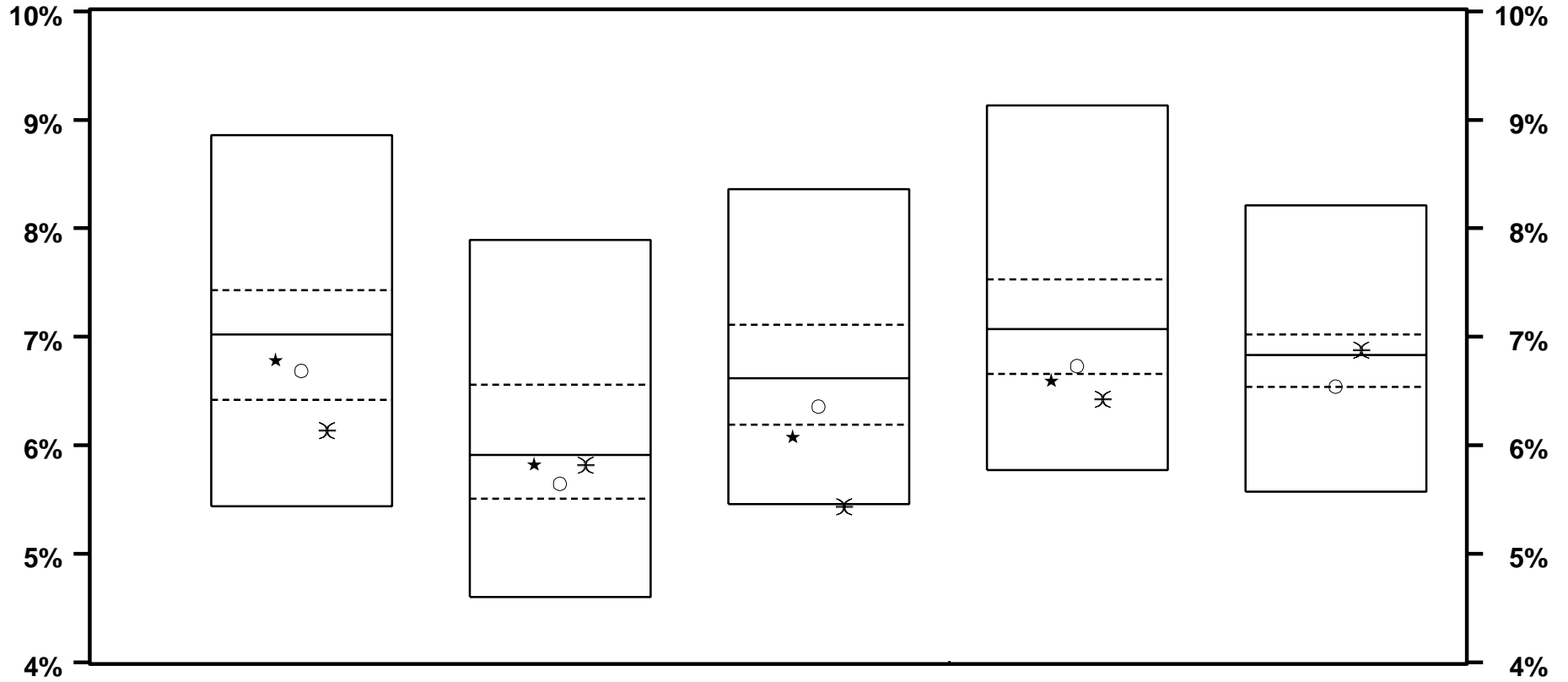

	LAST 6 YEARS		LAST 7 YEARS		LAST 8 YEARS		LAST 9 YEARS		LAST 10 YEARS	
★ MUNI COMPOSITE	6.8	64	5.8	55	6.1	78	6.6	76		
○ LB AGGREGATE	6.7	69	5.6	68	6.4	66	6.7	72	6.5	74
⌘ ML HIGH YLD II	6.1	84	5.8	57	5.4	95	6.4	83	6.9	41
MEDIAN	7.0		5.9		6.6		7.1		6.8	

VERMONT MUNICIPAL EMPLOYEES

BOND ONLY PUBLIC FUNDS - RATES OF RETURN

YEARS ENDING

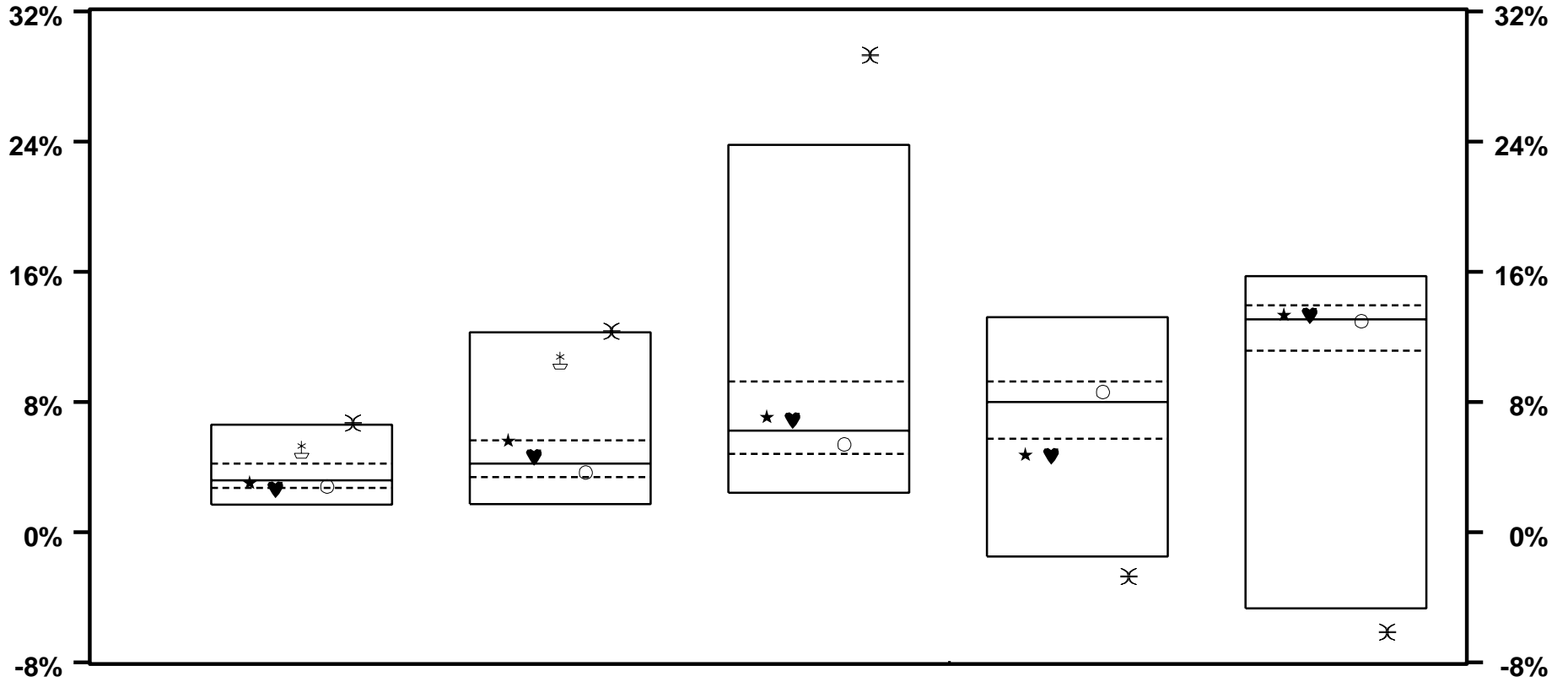

	9 / 05		9 / 04		9 / 03		9 / 02		9 / 01	
★ MUNI COMPOSITE	3.1	55	5.6	25	7.1	36	4.8	80	13.4	42
♥ SEIX CORE	2.6	79	4.6	39	6.9	37	4.7	81	13.3	43
⊠ SEIX HIGH YIELD	5.1	14	10.6	12						
○ LB AGGREGATE	2.8	69	3.7	65	5.4	66	8.6	38	13.0	54
⌘ ML HIGH YLD II	6.7	4	12.3	4	29.3	2	-2.7	96	-6.1	95
MEDIAN	3.2		4.2		6.2		8.0		13.1	

VERMONT MUNICIPAL EMPLOYEES

BOND ONLY PUBLIC FUNDS - RATES OF RETURN

YEARS ENDING

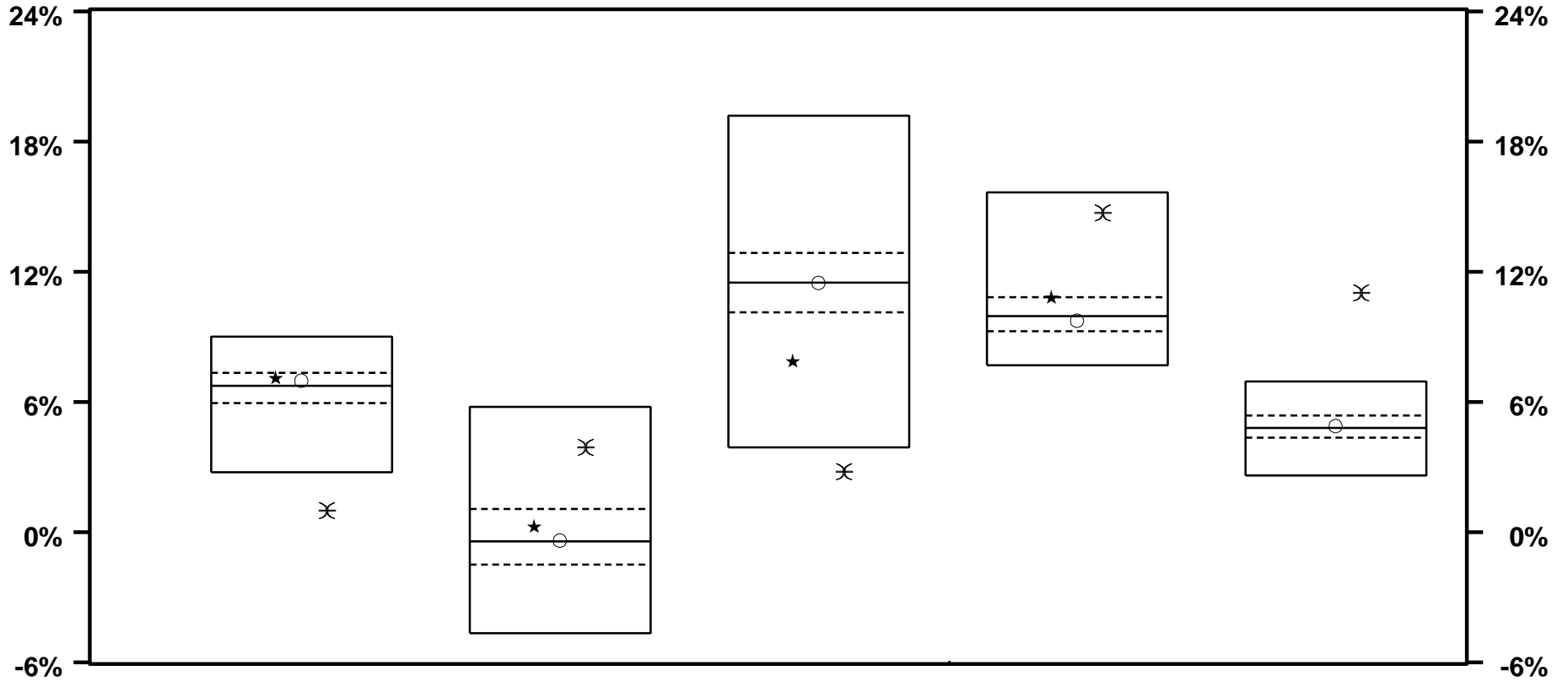

	9 / 00		9 / 99		9 / 98		9 / 97		9 / 96	
★ MUNI COMPOSITE	7.1	33	0.3	35	7.9	87	10.8	25		
○ LB AGGREGATE	7.0	39	-0.4	48	11.5	50	9.7	58	4.9	44
✕ ML HIGH YLD II	1.0	98	3.9	7	2.8	95	14.7	6	11.0	1
MEDIAN	6.7		-0.4		11.5		10.0		4.8	

VERMONT MUNICIPAL EMPLOYEES

BOND ONLY PUBLIC FUNDS - RETURN VS RISK

3 YEARS ENDING 9/05

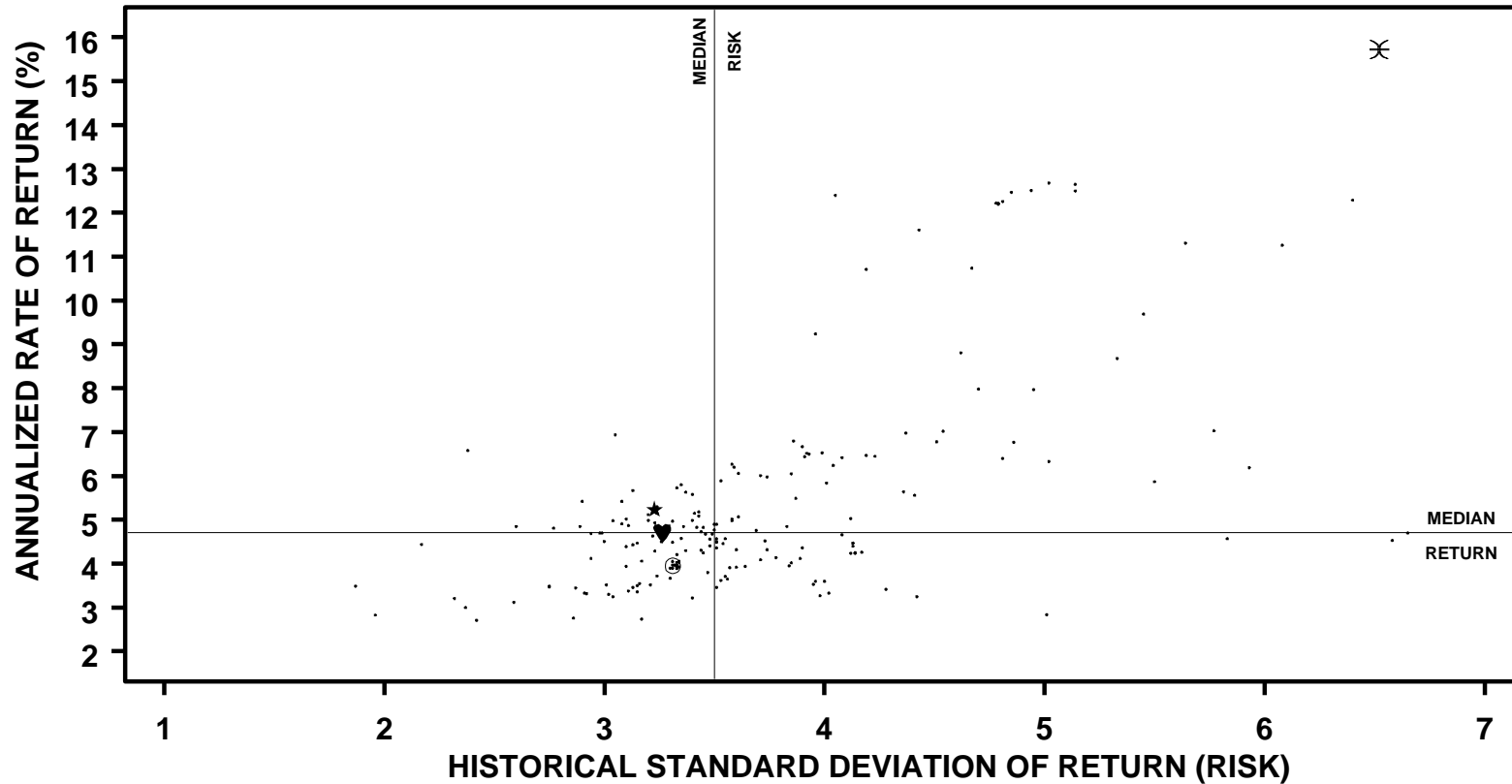

	ANNUALIZED RETURN		STANDARD DEVIATION		SHARPE RATIO	
	VALUE	RANK	VALUE	RANK	VALUE	RANK
★ MUNI COMPOSITE	5.2	35	3.2	72	1.1	31
♥ SEIX CORE	4.7	48	3.3	70	0.9	43
○ LB AGGREGATE	4.0	72	3.3	67	0.7	66
⌘ ML HIGH YLD II	15.7	1	6.5	6	2.1	7
MEDIAN	4.7		3.5		0.9	

VERMONT MUNICIPAL EMPLOYEES

BOND ONLY PUBLIC FUNDS - RETURN VS RISK

5 YEARS ENDING 9/05

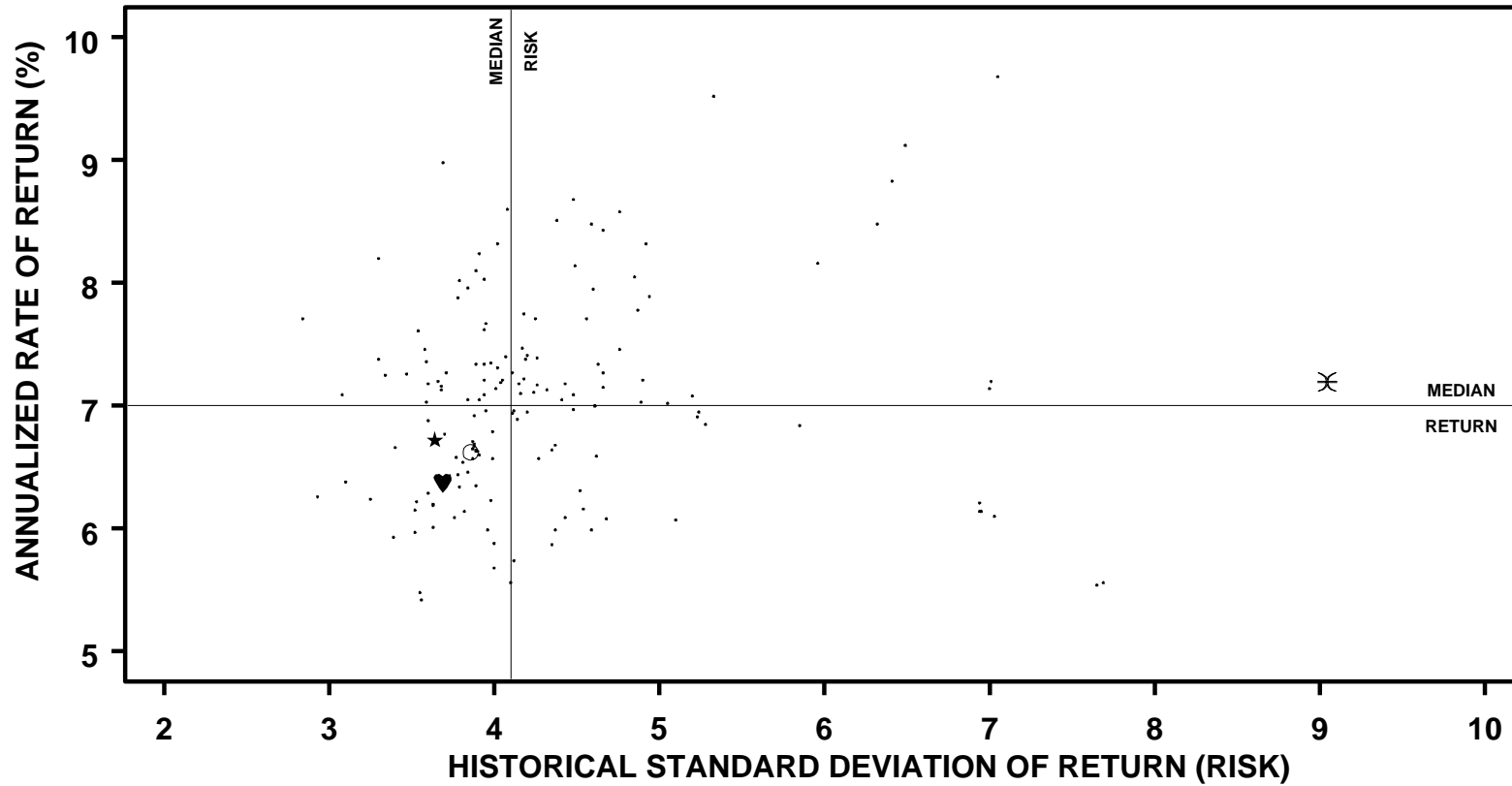

	ANNUALIZED RETURN		STANDARD DEVIATION		SHARPE RATIO	
	VALUE	RANK	VALUE	RANK	VALUE	RANK
★ MUNI COMPOSITE	6.7	61	3.6	79	1.1	32
♥ SEIX CORE	6.4	74	3.7	77	1.0	52
○ LB AGGREGATE	6.6	67	3.9	69	1.1	46
⌘ ML HIGH YLD II	7.2	39	9.0	1	0.5	94
MEDIAN	7.0		4.1		1.1	

VERMONT MUNICIPAL EMPLOYEES

PLAN ALLOCATION BY INVESTMENT MANDATE

AS OF 9/05

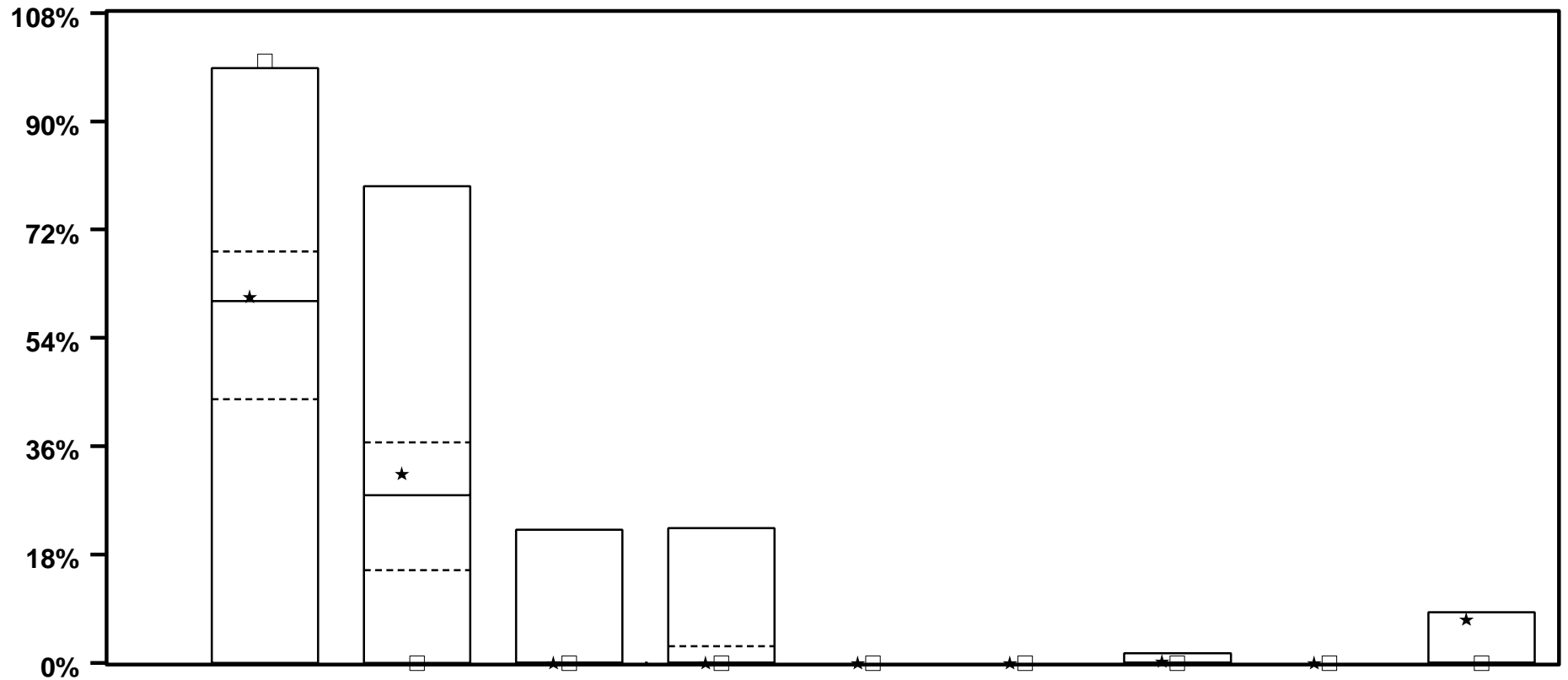

	EQUITY		BOND		BALANCED		HEDGE		VENTURE CAPITAL	PRIVATE DEBT	PRIVATE EQUITY		STABLE VALUE	REAL ESTATE	
★ MUNI COMPOSITE	60.8	47	31.4	38	0.0	12	0.0	27	0.0	0.0	0.2	8	0.0	7.2	6
□ EQTY COMPOSITE	100.0	1	0.0	87	0.0	12	0.0	27	0.0	0.0	0.0	10	0.0	0.0	20
MEDIAN	60.2		27.9		0.0		0.0				0.0			0.0	

VERMONT MUNICIPAL EMPLOYEES

PLAN ALLOCATION BY INVESTMENT MANDATE

AS OF 9/05

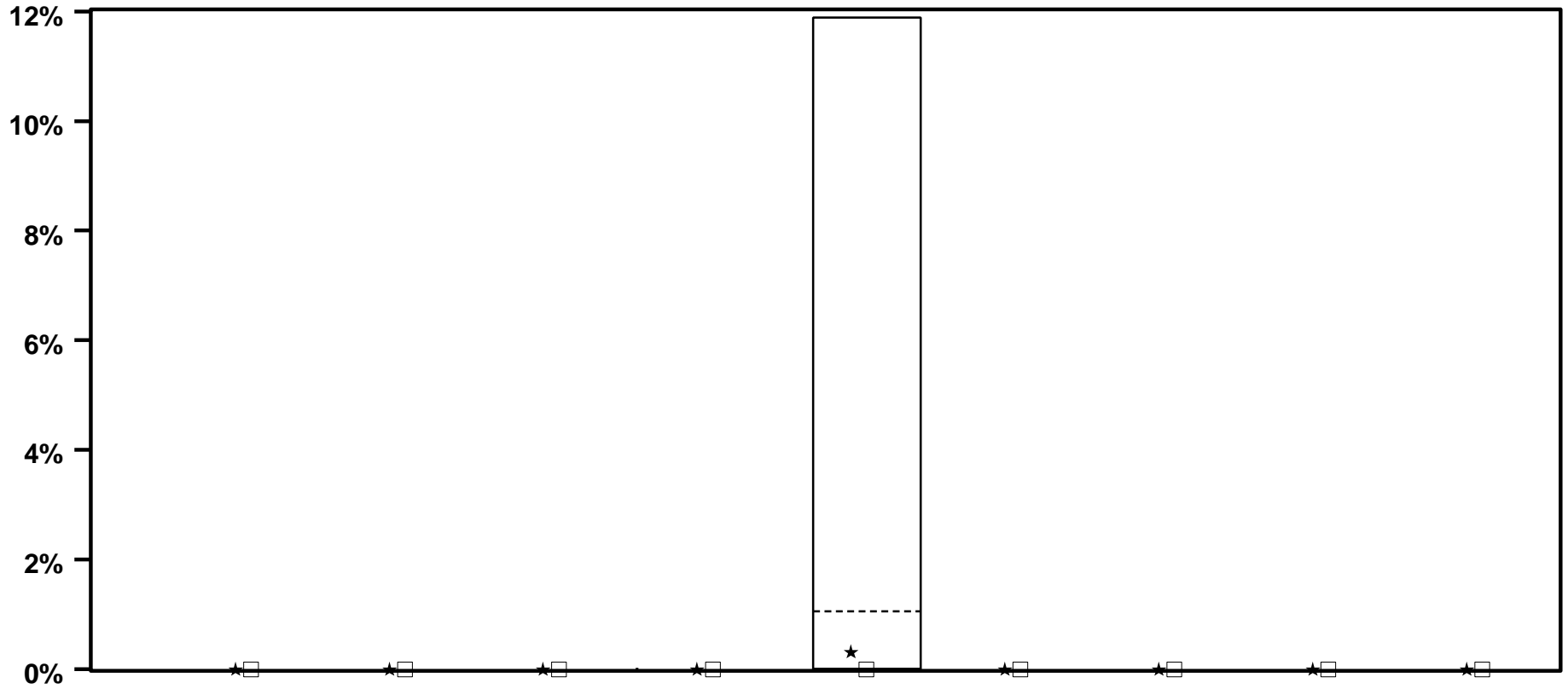

	TAAL	MORTGAGE	REIT	MISCE-LLANEOUS	TEMP INVEST	COMPANY STOCK	TAX-EXEMPT	IMMUNIZED	CONVERT-IBLE
★ MUNI COMPOSITE	0.0	0.0	0.0	0.0	0.3 36	0.0	0.0	0.0	0.0
□ EQTY COMPOSITE	0.0	0.0	0.0	0.0	0.0 50	0.0	0.0	0.0	0.0
MEDIAN					0.0				

VERMONT MUNICIPAL EMPLOYEES

PLAN EQUITY ALLOCATION BY INVESTMENT MANDATE

AS OF 9/05

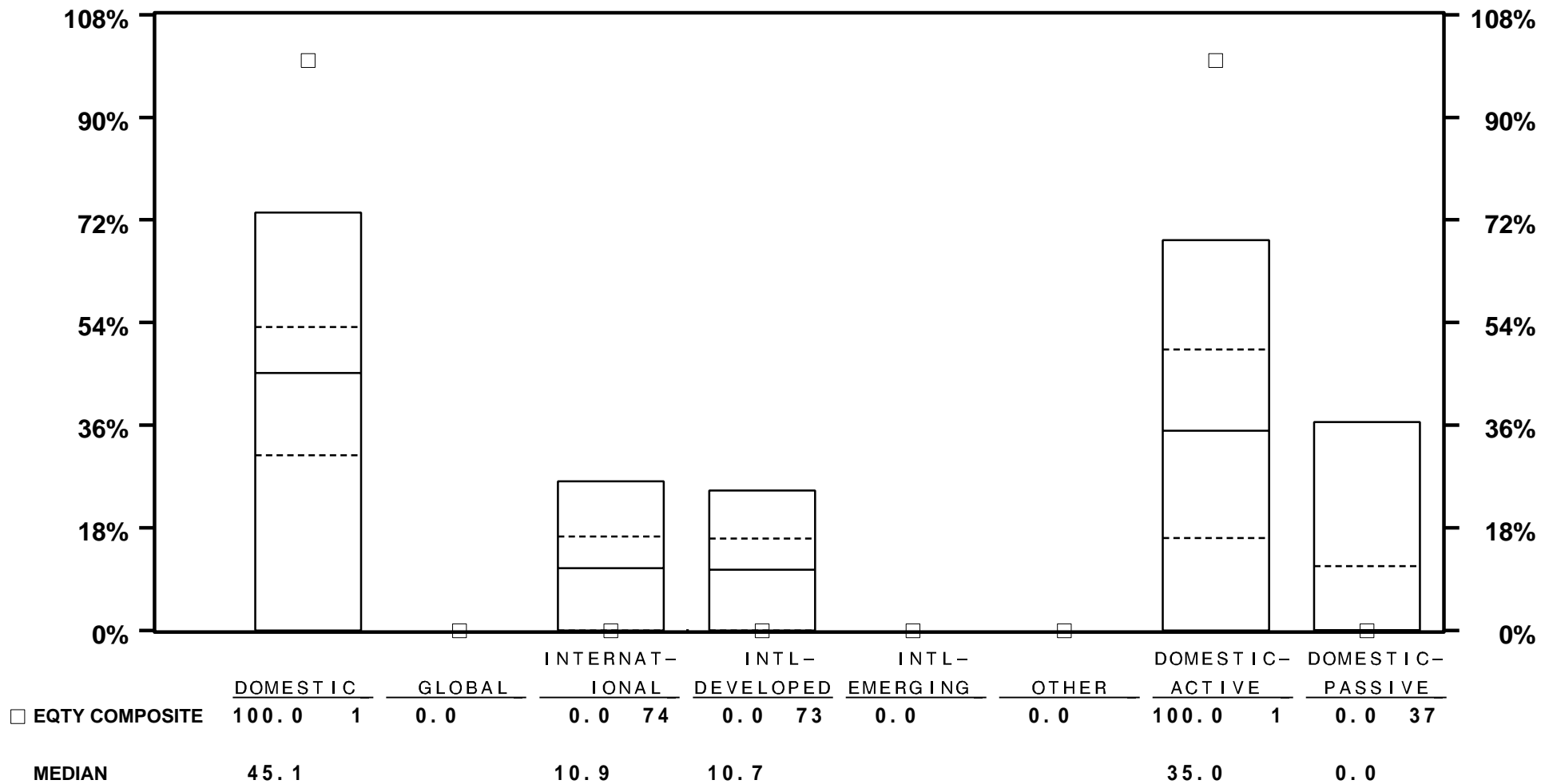

VERMONT MUNICIPAL EMPLOYEES

PLAN FIXED INCOME ALLOCATION BY INVESTMENT MANDATE

AS OF 9/05

