

**VERMONT MUNICIPAL EMPLOYEES
INVESTMENT PERFORMANCE ANALYSIS
MARCH 31, 2005**

VERMONT MUNICIPAL EMPLOYEES
TOTAL FUND ASSET GROWTH SUMMARY (\$000)
PERIODS ENDING 3/05

MUNICIPAL SYSTEM COMPOSITE

	<u>LAST QUARTER</u>	<u>YEAR TO DATE</u>	<u>LAST 12 MONTHS</u>	<u>SINCE INCEPTION 3/01</u>
BEGINNING MARKET VALUE	239,747	239,747	218,194	163,148
NET EXTERNAL GROWTH	2,436	2,436	7,252	28,402
RETURN ON INVESTMENT	- 3,368	- 3,368	13,369	47,265
INCOME RECEIVED	837	837	8,148	17,915
GAIN/LOSS	- 4,205	- 4,205	5,221	29,350
ENDING MARKET VALUES	238,815	238,815	238,815	238,815

VERMONT MUNICIPAL EMPLOYEES
TOTAL FUND ASSET GROWTH SUMMARY (\$000)
PERIODS ENDING 3/05

DOMESTIC EQUITY COMPOSITE

	<u>LAST QUARTER</u>	<u>YEAR TO DATE</u>	<u>LAST 12 MONTHS</u>	<u>SINCE INCEPTION 3/01</u>
BEGINNING MARKET VALUE	107,767	107,767	96,733	65,832
NET EXTERNAL GROWTH	- 2,049	- 2,049	820	16,481
RETURN ON INVESTMENT	- 3,506	- 3,506	4,659	19,899
INCOME RECEIVED	229	229	4,989	7,593
GAIN/LOSS	- 3,735	- 3,735	- 330	12,306
ENDING MARKET VALUES	102,212	102,212	102,212	102,212

VERMONT MUNICIPAL EMPLOYEES
TOTAL FUND ASSET GROWTH SUMMARY (\$000)
PERIODS ENDING 3/05

DELAWARE

	<u>LAST QUARTER</u>	<u>YEAR TO DATE</u>	<u>LAST 12 MONTHS</u>	<u>SINCE INCEPTION 6/00</u>
BEGINNING MARKET VALUE	41,975	41,975	38,329	24,252
NET EXTERNAL GROWTH	0	0	0	5,077
RETURN ON INVESTMENT	- 538	- 538	3,108	12,108
INCOME RECEIVED	229	229	795	2,861
GAIN/LOSS	- 766	- 766	2,313	9,247
ENDING MARKET VALUES	41,437	41,437	41,437	41,437

VERMONT MUNICIPAL EMPLOYEES
TOTAL FUND ASSET GROWTH SUMMARY (\$000)
PERIODS ENDING 3/05

ALLIANCE LARGE CAP GROWTH FUND

	<u>LAST QUARTER</u>	<u>YEAR TO DATE</u>	<u>LAST 12 MONTHS</u>	<u>SINCE INCEPTION 6/00</u>
BEGINNING MARKET VALUE	39,569	39,569	34,671	35,650
NET EXTERNAL GROWTH	0	0	3,000	12,500
RETURN ON INVESTMENT	- 2,453	- 2,453	- 555	- 11,034
INCOME RECEIVED	0	0	0	17
GAIN/LOSS	- 2,453	- 2,453	- 555	- 11,051
ENDING MARKET VALUES	37,116	37,116	37,116	37,116

VERMONT MUNICIPAL EMPLOYEES
TOTAL FUND ASSET GROWTH SUMMARY (\$000)
PERIODS ENDING 3/05

LAZARD SMALL CAP FUND

	<u>LAST QUARTER</u>	<u>YEAR TO DATE</u>	<u>LAST 12 MONTHS</u>	<u>SINCE INCEPTION 6/00</u>
BEGINNING MARKET VALUE	26, 223	26, 223	23, 733	13, 335
NET EXTERNAL GROWTH	- 2, 049	- 2, 049	- 2, 181	- 1, 096
RETURN ON INVESTMENT	- 516	- 516	2, 106	11, 419
INCOME RECEIVED	0	0	4, 195	4, 714
GAIN/LOSS	- 516	- 516	- 2, 089	6, 705
ENDING MARKET VALUES	23, 659	23, 659	23, 659	23, 659

VERMONT MUNICIPAL EMPLOYEES
TOTAL FUND ASSET GROWTH SUMMARY (\$000)
PERIODS ENDING 3/05

BRINSON - UBS

	<u>LAST QUARTER</u>	<u>YEAR TO DATE</u>	<u>LAST 12 MONTHS</u>	<u>SINCE INCEPTION 6/00</u>
BEGINNING MARKET VALUE	41,888	41,888	36,136	26,395
NET EXTERNAL GROWTH	- 2,000	- 2,000	- 2,006	6,453
RETURN ON INVESTMENT	- 165	- 165	5,592	6,875
INCOME RECEIVED	- 4	- 4	- 4	2
GAIN/LOSS	- 161	- 161	5,596	6,874
ENDING MARKET VALUES	39,723	39,723	39,723	39,723

VERMONT MUNICIPAL EMPLOYEES
TOTAL FUND ASSET GROWTH SUMMARY (\$000)
PERIODS ENDING 3/05

MET LIFE / SSR TOWER FUND

	<u>LAST QUARTER</u>	<u>YEAR TO DATE</u>	<u>LAST 12 MONTHS</u>	<u>SINCE INCEPTION 6/00</u>
BEGINNING MARKET VALUE	14,404	14,404	13,767	11,355
NET EXTERNAL GROWTH	2,000	2,000	1,882	1,581
RETURN ON INVESTMENT	598	598	1,354	4,067
INCOME RECEIVED	0	0	0	1,399
GAIN/LOSS	598	598	1,354	2,668
ENDING MARKET VALUES	17,003	17,003	17,003	17,003

VERMONT MUNICIPAL EMPLOYEES
TOTAL FUND ASSET GROWTH SUMMARY (\$000)
PERIODS ENDING 3/05

SEIX CORE

	<u>LAST QUARTER</u>	<u>YEAR TO DATE</u>	<u>LAST 12 MONTHS</u>	<u>SINCE INCEPTION 6/00</u>
BEGINNING MARKET VALUE	62,842	62,842	53,342	53,366
NET EXTERNAL GROWTH	3,000	3,000	11,000	- 5,461
RETURN ON INVESTMENT	- 144	- 144	1,356	17,793
INCOME RECEIVED	413	413	1,697	6,749
GAIN/LOSS	- 557	- 557	- 341	11,044
ENDING MARKET VALUES	65,698	65,698	65,698	65,698

VERMONT MUNICIPAL EMPLOYEES
TOTAL FUND ASSET GROWTH SUMMARY (\$000)
PERIODS ENDING 3/05

SEIX HIGH YIELD

	<u>LAST QUARTER</u>	<u>YEAR TO DATE</u>	<u>LAST 12 MONTHS</u>	<u>SINCE INCEPTION 6/03</u>
BEGINNING MARKET VALUE	11,461	11,461	10,804	9,055
NET EXTERNAL GROWTH	984	984	939	1,898
RETURN ON INVESTMENT	-177	-177	525	1,315
INCOME RECEIVED	179	179	829	1,238
GAIN/LOSS	-356	-356	-304	77
ENDING MARKET VALUES	12,269	12,269	12,269	12,269

VERMONT MUNICIPAL EMPLOYEES
TOTAL FUND ASSET GROWTH SUMMARY (\$000)
PERIODS ENDING 3/05

ALTERNATIVE INVESTMENTS

	<u>LAST QUARTER</u>	<u>YEAR TO DATE</u>	<u>LAST 12 MONTHS</u>	<u>SINCE INCEPTION 6/00</u>
BEGINNING MARKET VALUE	7 4 0	7 4 0	8 3 0	1 , 0 3 6
NET EXTERNAL GROWTH	0	0	8 0	8 0
RETURN ON INVESTMENT	1	1	- 1 6 9	- 3 7 5
INCOME RECEIVED	1	1	1	6 5
GAIN/LOSS	0	0	- 1 7 1	- 4 4 0
ENDING MARKET VALUES	7 4 1	7 4 1	7 4 1	7 4 1

VERMONT MUNICIPAL EMPLOYEES
TOTAL FUND ASSET GROWTH SUMMARY (\$000)
PERIODS ENDING 3/05

VERMONT INVESTMENTS

	<u>LAST QUARTER</u>	<u>YEAR TO DATE</u>	<u>LAST 12 MONTHS</u>	<u>SINCE INCEPTION 3/01</u>
BEGINNING MARKET VALUE	645	645	6,581	526
NET EXTERNAL GROWTH	500	500	-5,463	339
RETURN ON INVESTMENT	25	25	52	305
INCOME RECEIVED	20	20	635	869
GAIN/LOSS	5	5	-583	-564
ENDING MARKET VALUES	1,170	1,170	1,170	1,170

VERMONT MUNICIPAL EMPLOYEES

PORTFOLIO ASSET GROWTH SUMMARY (\$000)

QUARTER ENDING 3/05

PORTFOLIO	BEGINNING VALUE	NET CONTR	INCOME RECEIVED	GAIN (LOSS)	END VALUE
MUNI COMPOSITE	239,747	2,436	837	-4,205	238,815
EQTY COMPOSITE	107,767	-2,049	229	-3,735	102,212
DELAWARE	41,975	0	229	-766	41,437
ALLIANCE	39,569	0	0	-2,453	37,116
LAZARD	26,223	-2,049	0	-516	23,659
UBS	41,888	-2,000	-4	-161	39,723
SSR TOWER FUND	14,404	2,000	0	598	17,003
SEIX CORE	62,842	3,000	413	-557	65,698
SEIX HIGH YIELD	11,461	984	179	-356	12,269
ALT. ASSETS	740	0	1	0	741
VERMONT INVEST	645	500	20	5	1,170

YEAR TO DATE

PORTFOLIO	BEGINNING VALUE	NET CONTR	INCOME RECEIVED	GAIN (LOSS)	END VALUE
MUNI COMPOSITE	239,747	2,436	837	-4,205	238,815
EQTY COMPOSITE	107,767	-2,049	229	-3,735	102,212
DELAWARE	41,975	0	229	-766	41,437
ALLIANCE	39,569	0	0	-2,453	37,116
LAZARD	26,223	-2,049	0	-516	23,659
UBS	41,888	-2,000	-4	-161	39,723
SSR TOWER FUND	14,404	2,000	0	598	17,003
SEIX CORE	62,842	3,000	413	-557	65,698
SEIX HIGH YIELD	11,461	984	179	-356	12,269
ALT. ASSETS	740	0	1	0	741
VERMONT INVEST	645	500	20	5	1,170

VERMONT MUNICIPAL EMPLOYEES

PORTFOLIO ASSET GROWTH SUMMARY (\$000)

YEAR ENDING 3/05

PORTFOLIO	BEGINNING VALUE	NET CONTR	INCOME RECEIVED	GAIN (LOSS)	END VALUE
MUNI COMPOSITE	218,194	7,252	8,148	5,221	238,815
EQTY COMPOSITE	96,733	820	4,989	-330	102,212
DELAWARE	38,329	0	795	2,313	41,437
ALLIANCE	34,671	3,000	0	-555	37,116
LAZARD	23,733	-2,181	4,195	-2,089	23,659
UBS	36,136	-2,006	-4	5,596	39,723
SSR TOWER FUND	13,767	1,882	0	1,354	17,003
SEIX CORE	53,342	11,000	1,697	-341	65,698
SEIX HIGH YIELD	10,804	939	829	-304	12,269
ALT. ASSETS	830	80	1	-171	741
VERMONT INVEST	6,581	-5,463	635	-583	1,170

VERMONT MUNICIPAL EMPLOYEES

ASSET ALLOCATION SUMMARY

AS OF 3/05

	MARKET VALUE (\$000)	COMMON STOCK	INT'L COMMON STOCK	BONDS	INT'L BONDS	CONV	CASH EQUIV	MORT	REAL ESTATE	SV ASSETS	PRVT INVEST	MISC
** TOTAL FUND **												
MUNI COMPOSITE	238,815	42.7	16.6	32.8			0.5		7.1		0.2	
MEDIAN		47.8	11.1	29.2	0.0		2.0		0.0		0.0	0.0
** EQUITY MANAGERS **												
EQTY COMPOSITE	102,212	99.8					0.2					
DELAWARE	41,437	99.4					0.6					
ALLIANCE	37,116	100.0										
LAZARD	23,659	100.0										
MEDIAN		99.8										
** BOND MANAGERS **												
SEIX CORE	65,698			100.0								
SEIX HIGH YIELD	12,269			100.0								
MEDIAN				100.0								

VERMONT MUNICIPAL EMPLOYEES

ASSET ALLOCATION SUMMARY

AS OF 3/05

	MARKET VALUE (\$000)	COMMON STOCK	INT'L COMMON STOCK	BONDS	INT'L BONDS	CONV	CASH EQUIV	MORT	REAL ESTATE	SV ASSETS	PRVT INVEST	MISC
** CASH EQUIV MANAGERS **												
VERMONT INVEST	1,170			27.1			72.9					
MEDIAN												
** INT'L DEVELOPED MKT EQUITY MANAGERS **												
UBS	39,723		100.0				0.0					
MEDIAN												
** REAL ESTATE MANAGERS **												
SSR TOWER FUND	17,003								100.0			
MEDIAN												
** PRIVATE EQUITY MANAGERS **												
ALT. ASSETS	741						21.5				78.5	
MEDIAN												

VERMONT MUNICIPAL EMPLOYEES
ASSET ALLOCATION ANALYSIS
AS OF MARCH 31, 2005

DELAWARE

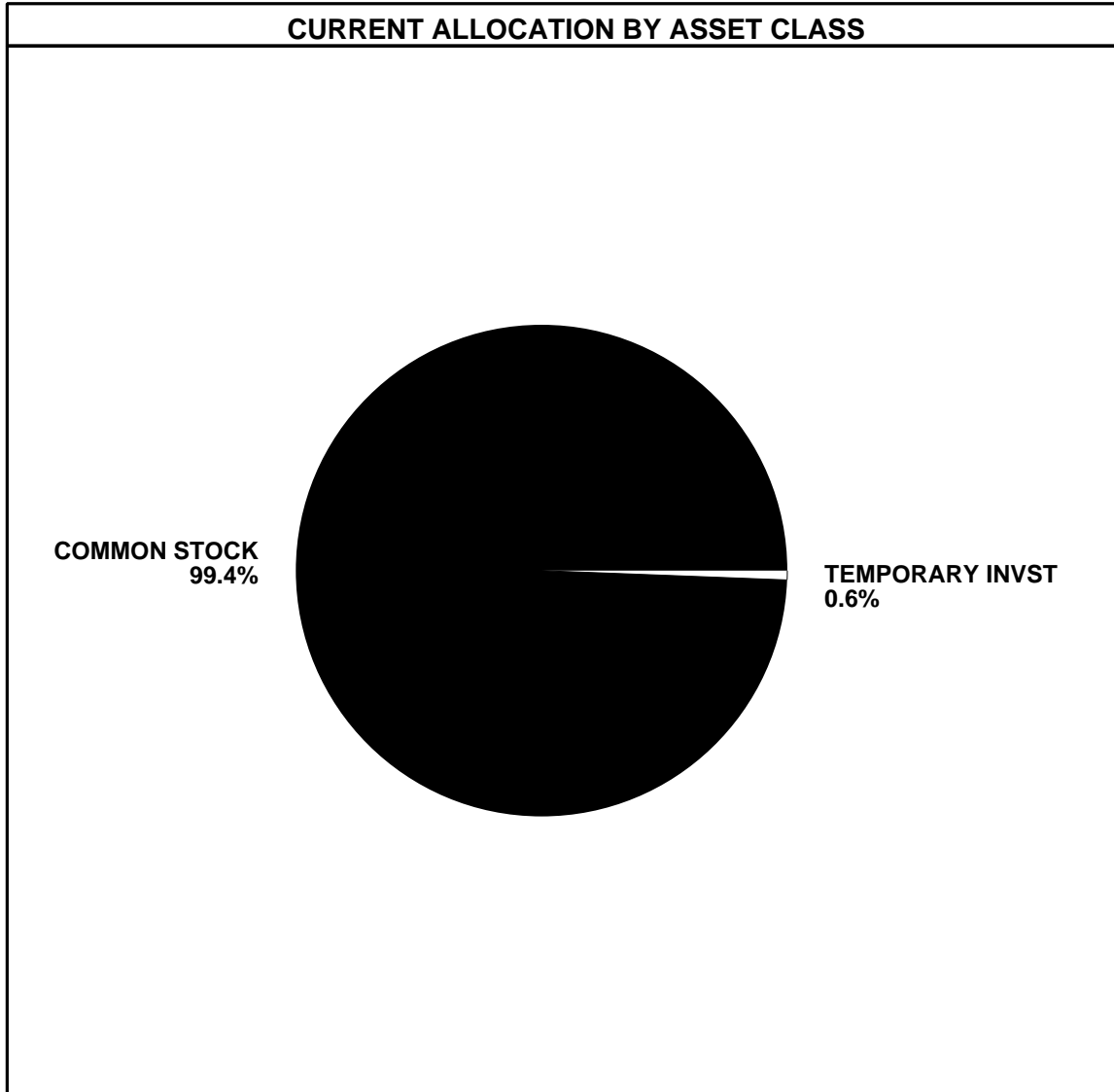

<u>ASSET CLASS</u>	<u>CURRENT DOLLARS</u>	<u>CURRENT %</u>
COMMON STOCK	41,205,882	99.4
TEMPORARY INVST	231,529	0.6
TOTAL	41,437,411	100.0

VERMONT MUNICIPAL EMPLOYEES
ASSET ALLOCATION ANALYSIS
AS OF MARCH 31, 2005

ALLIANCE LARGE CAP GROWTH FUND

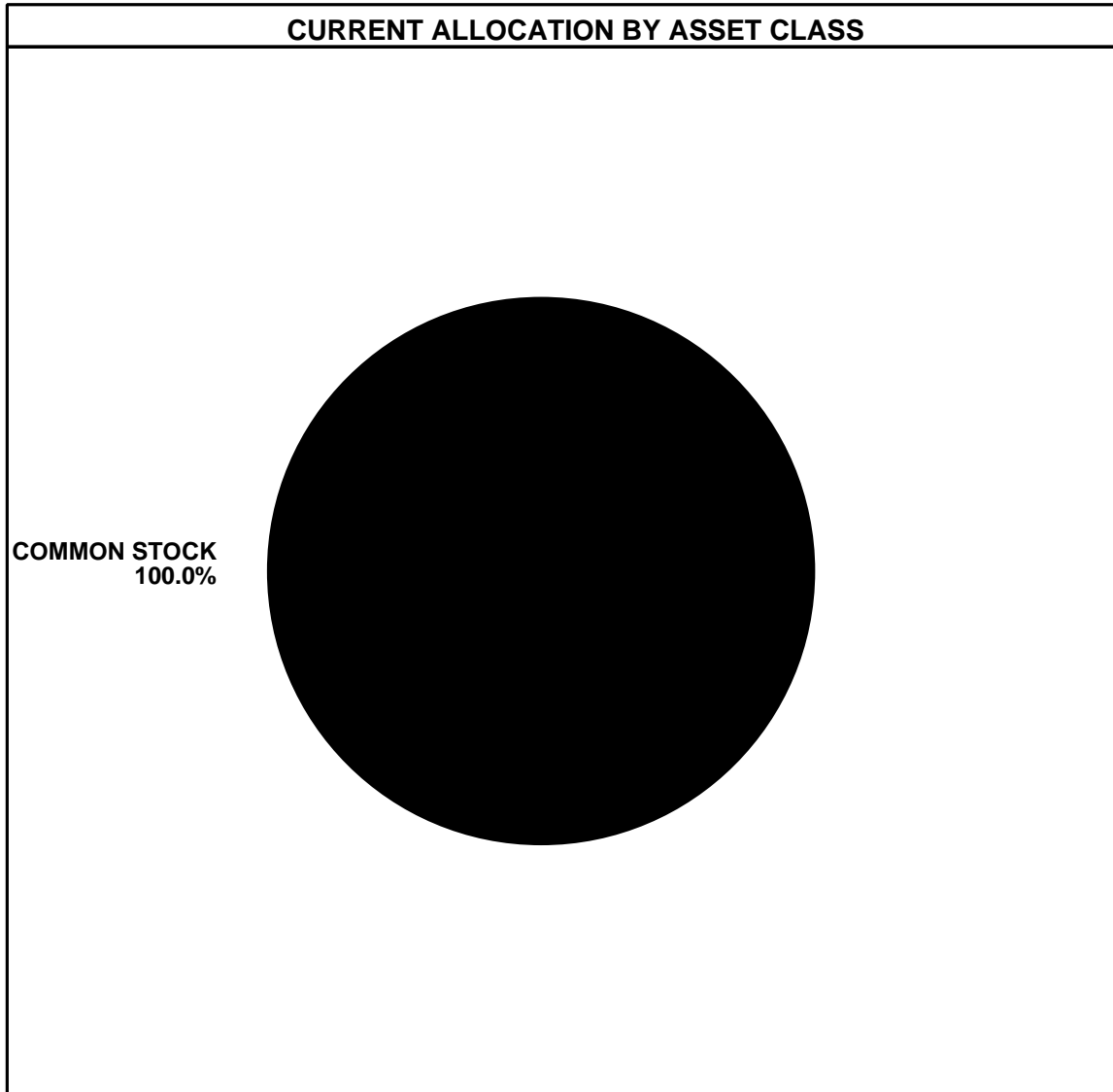

<u>ASSET CLASS</u>	<u>CURRENT DOLLARS</u>	<u>CURRENT %</u>
COMMON STOCK	<u>37,115,764</u>	<u>100.0</u>
TOTAL	37,115,764	100.0

VERMONT MUNICIPAL EMPLOYEES
ASSET ALLOCATION ANALYSIS
AS OF MARCH 31, 2005

LAZARD SMALL CAP FUND

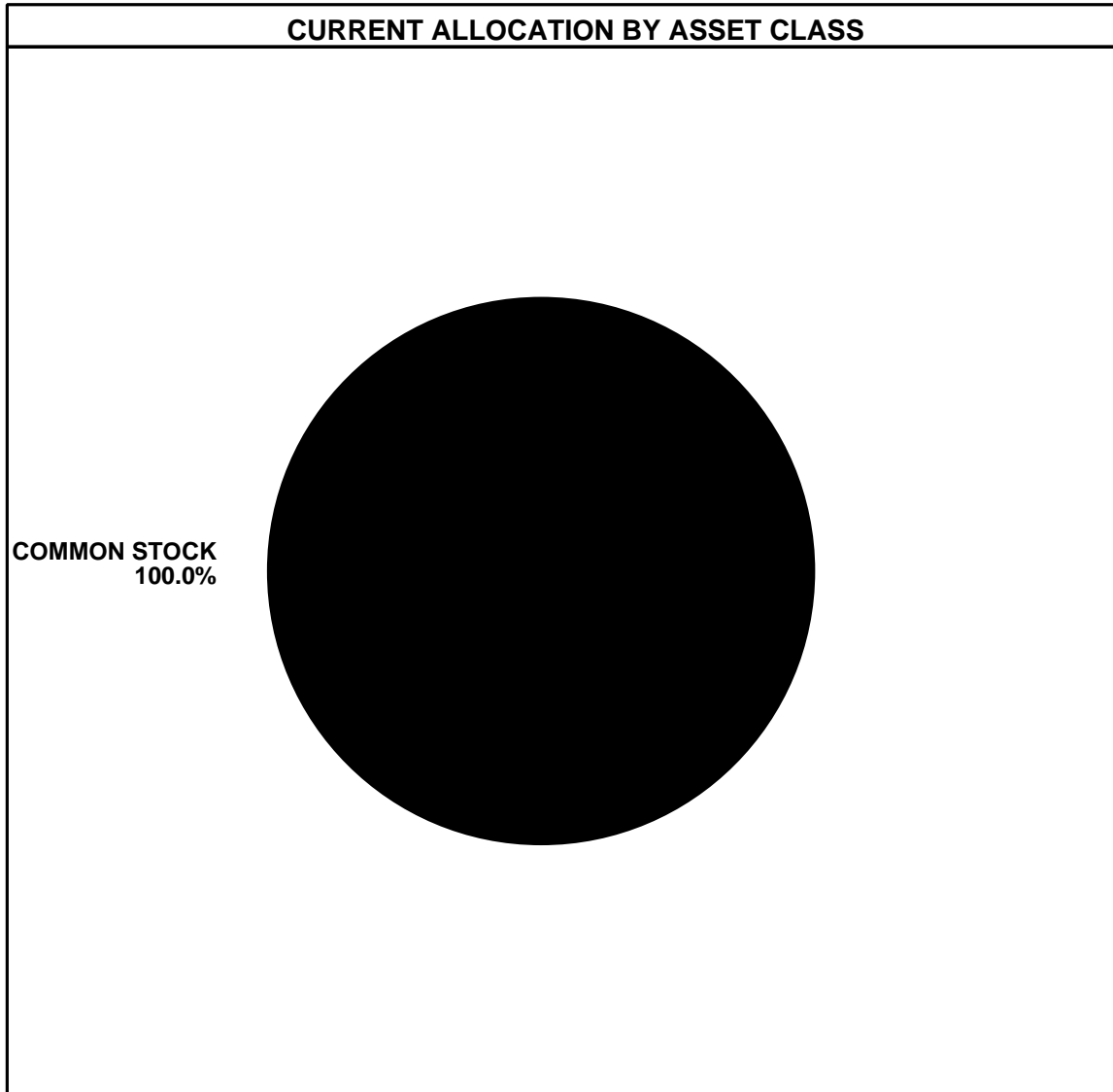

<u>ASSET CLASS</u>	<u>CURRENT DOLLARS</u>	<u>CURRENT %</u>
COMMON STOCK	<u>23,658,501</u>	<u>100.0</u>
TOTAL	23,658,501	100.0

VERMONT MUNICIPAL EMPLOYEES
ASSET ALLOCATION ANALYSIS
AS OF MARCH 31, 2005

BRINSON - UBS

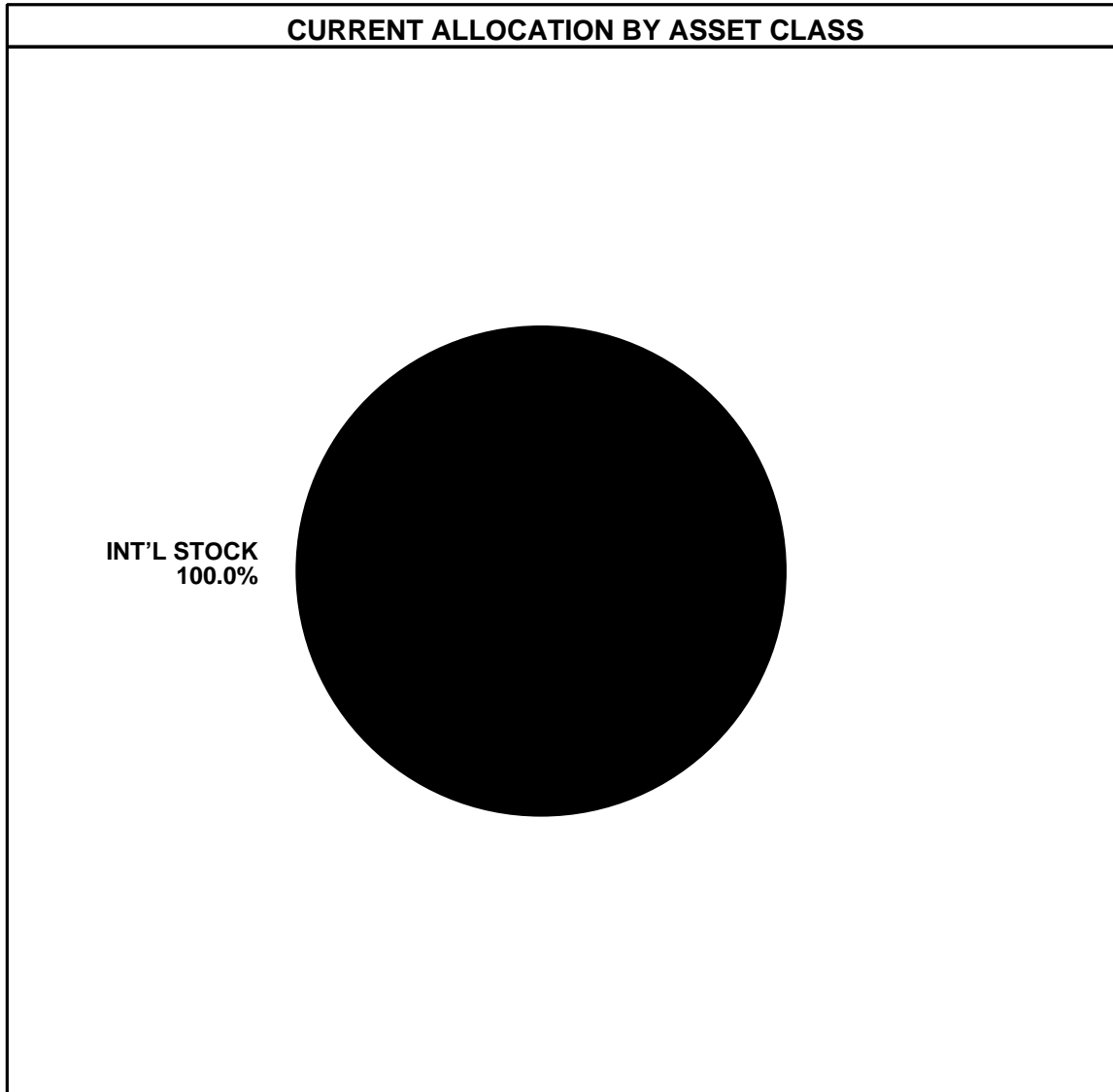

<u>ASSET CLASS</u>	<u>CURRENT DOLLARS</u>	<u>CURRENT %</u>
INT'L STOCK	39,715,213	100.0
TEMPORARY INVST	<u>8,015</u>	<u>0.0</u>
TOTAL	39,723,228	100.0

VERMONT MUNICIPAL EMPLOYEES
ASSET ALLOCATION ANALYSIS
AS OF MARCH 31, 2005

SEIX CORE

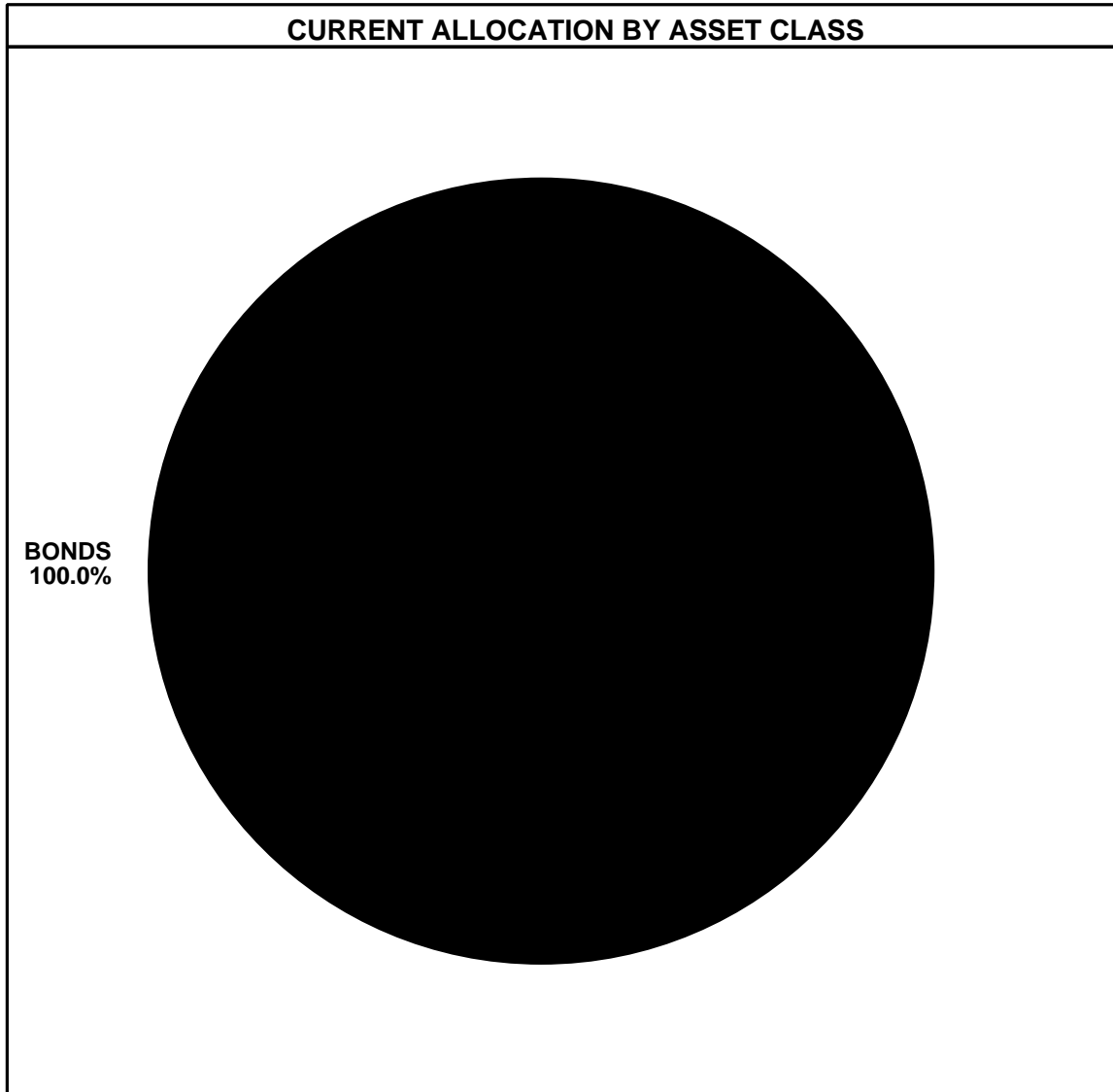

<u>ASSET CLASS</u>	<u>CURRENT DOLLARS</u>	<u>CURRENT %</u>
BONDS	<u>65,697,950</u>	<u>100.0</u>
TOTAL	65,697,950	100.0

VERMONT MUNICIPAL EMPLOYEES
ASSET ALLOCATION ANALYSIS
AS OF MARCH 31, 2005

SEIX HIGH YIELD

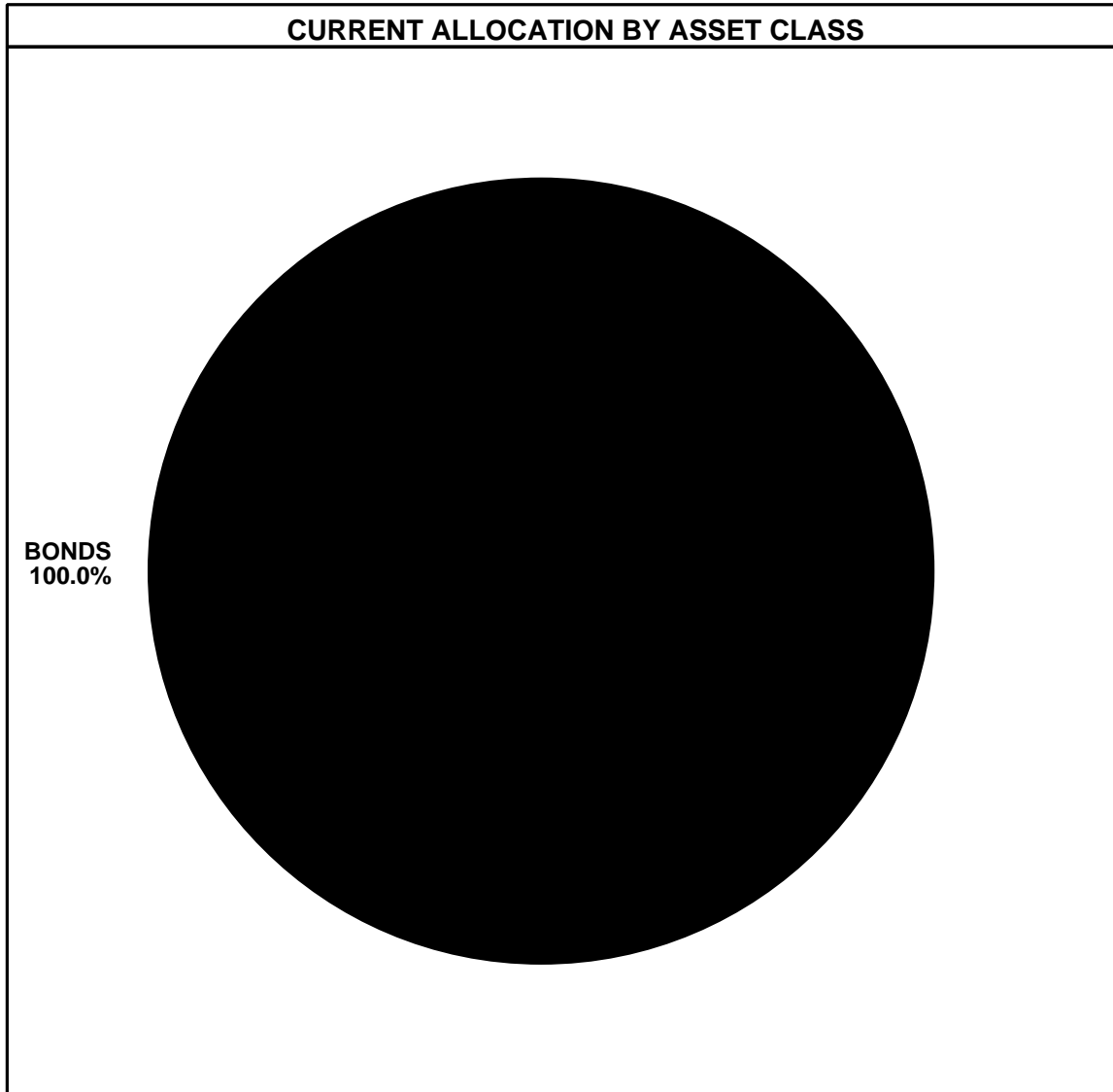

<u>ASSET CLASS</u>	<u>CURRENT DOLLARS</u>	<u>CURRENT %</u>
BONDS	<u>12,268,684</u>	<u>100.0</u>
TOTAL	12,268,684	100.0

VERMONT MUNICIPAL EMPLOYEES
ASSET ALLOCATION ANALYSIS
AS OF MARCH 31, 2005

MUNICIPAL SYSTEM COMPOSITE

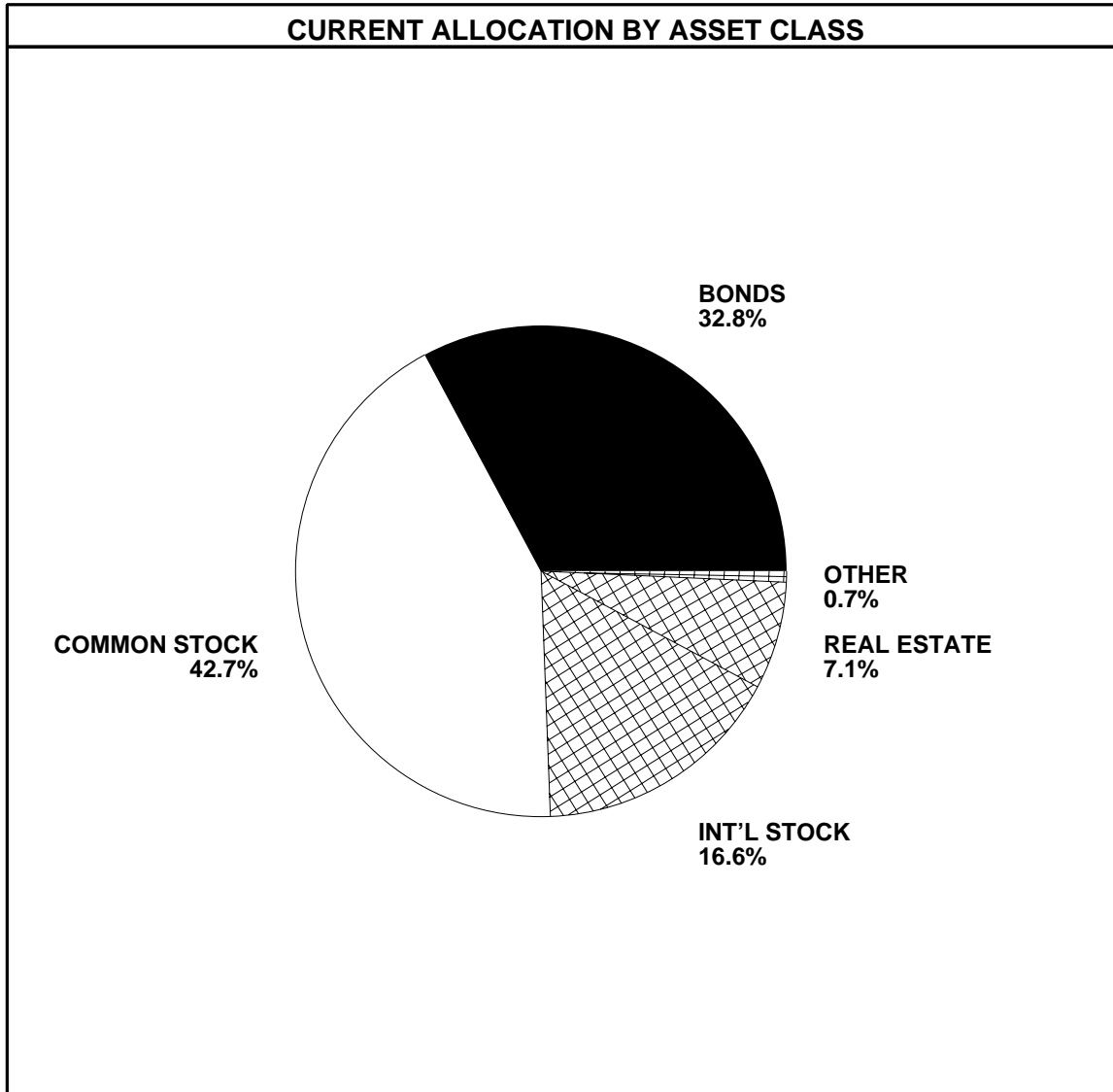

<u>ASSET CLASS</u>	<u>CURRENT DOLLARS</u>	<u>CURRENT %</u>
COMMON STOCK	101,980,147	42.7
INT'L STOCK	39,715,213	16.6
TEMPORARY INVST	1,251,740	0.5
BONDS	78,283,379	32.8
REAL ESTATE	17,002,951	7.1
PRIVATE INVEST	581,610	0.2
TOTAL	238,815,040	100.0

VERMONT MUNICIPAL EMPLOYEES
ASSET ALLOCATION ANALYSIS
AS OF MARCH 31, 2005

DOMESTIC EQUITY COMPOSITE

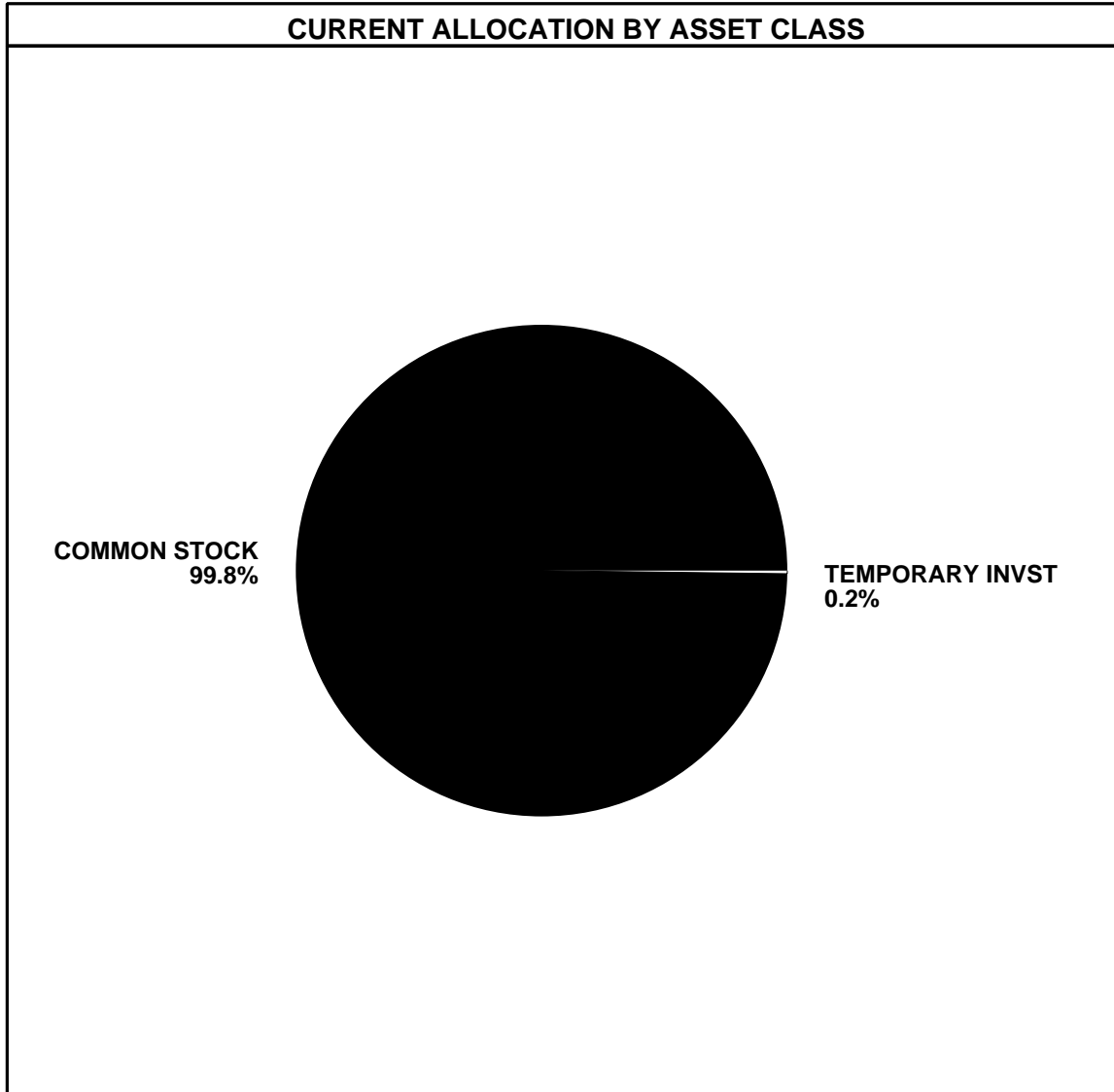

<u>ASSET CLASS</u>	<u>CURRENT DOLLARS</u>	<u>CURRENT %</u>
COMMON STOCK	101,980,147	99.8
TEMPORARY INVST	<u>231,529</u>	<u>0.2</u>
TOTAL	102,211,676	100.0

VERMONT MUNICIPAL EMPLOYEES
ALLOCATION BY MANAGER TYPE ANALYSIS
AS OF MARCH 31, 2005

MUNICIPAL SYSTEM COMPOSITE

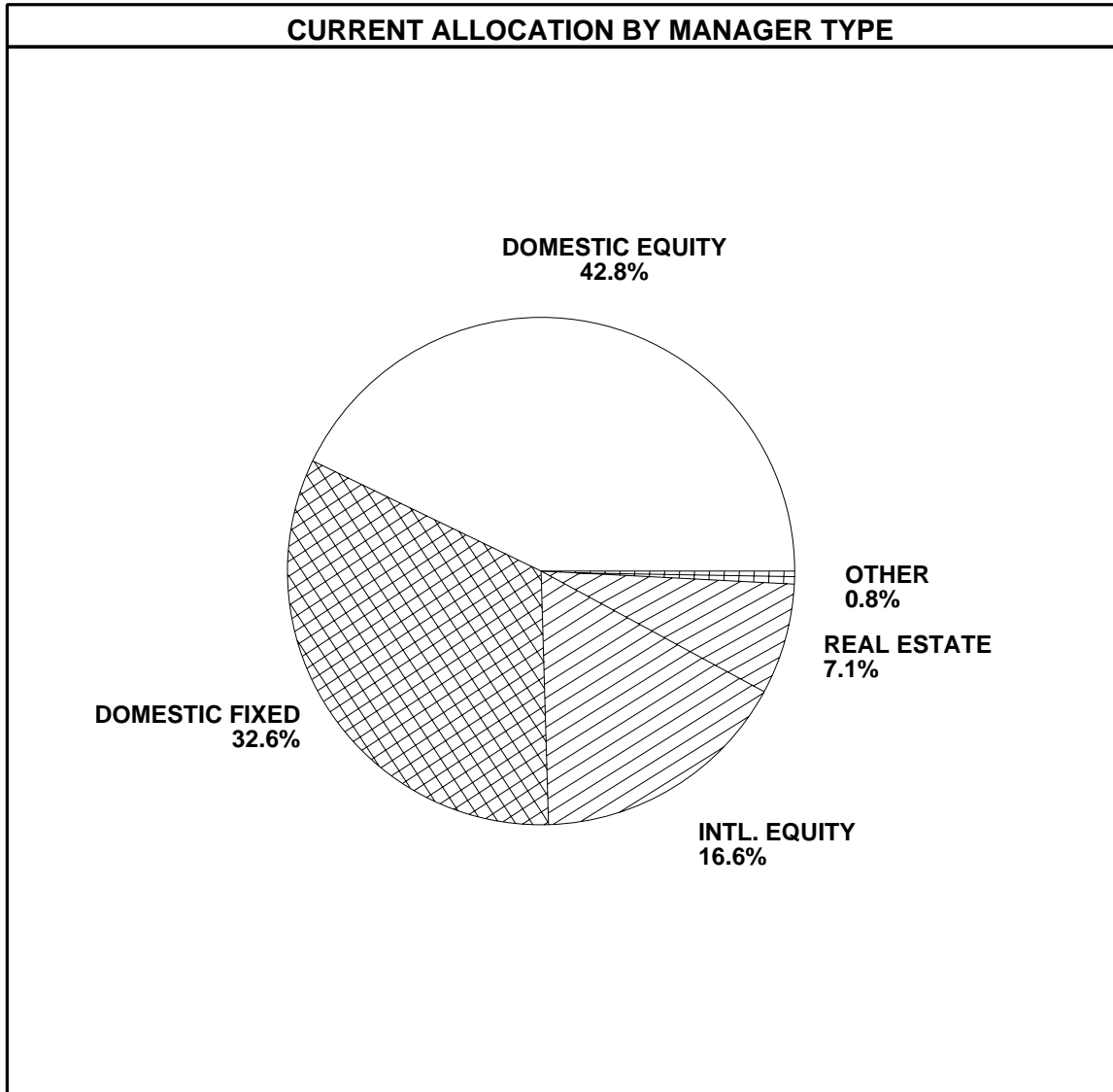

<u>MANAGER TYPE</u>	<u>CURRENT DOLLARS</u>	<u>CURRENT %</u>
CASH	1,169,822	0.5
DOMESTIC EQUITY	102,211,676	42.8
INTL. EQUITY	39,723,228	16.6
DOMESTIC FIXED	77,966,634	32.6
REAL ESTATE	17,002,951	7.1
PRIVATE EQUITY	<u>740,729</u>	<u>0.3</u>
TOTAL	238,815,040	100.0

VERMONT MUNICIPAL EMPLOYEES
MANAGER ALLOCATION ANALYSIS
AS OF MARCH 31, 2005

MUNICIPAL SYSTEM COMPOSITE

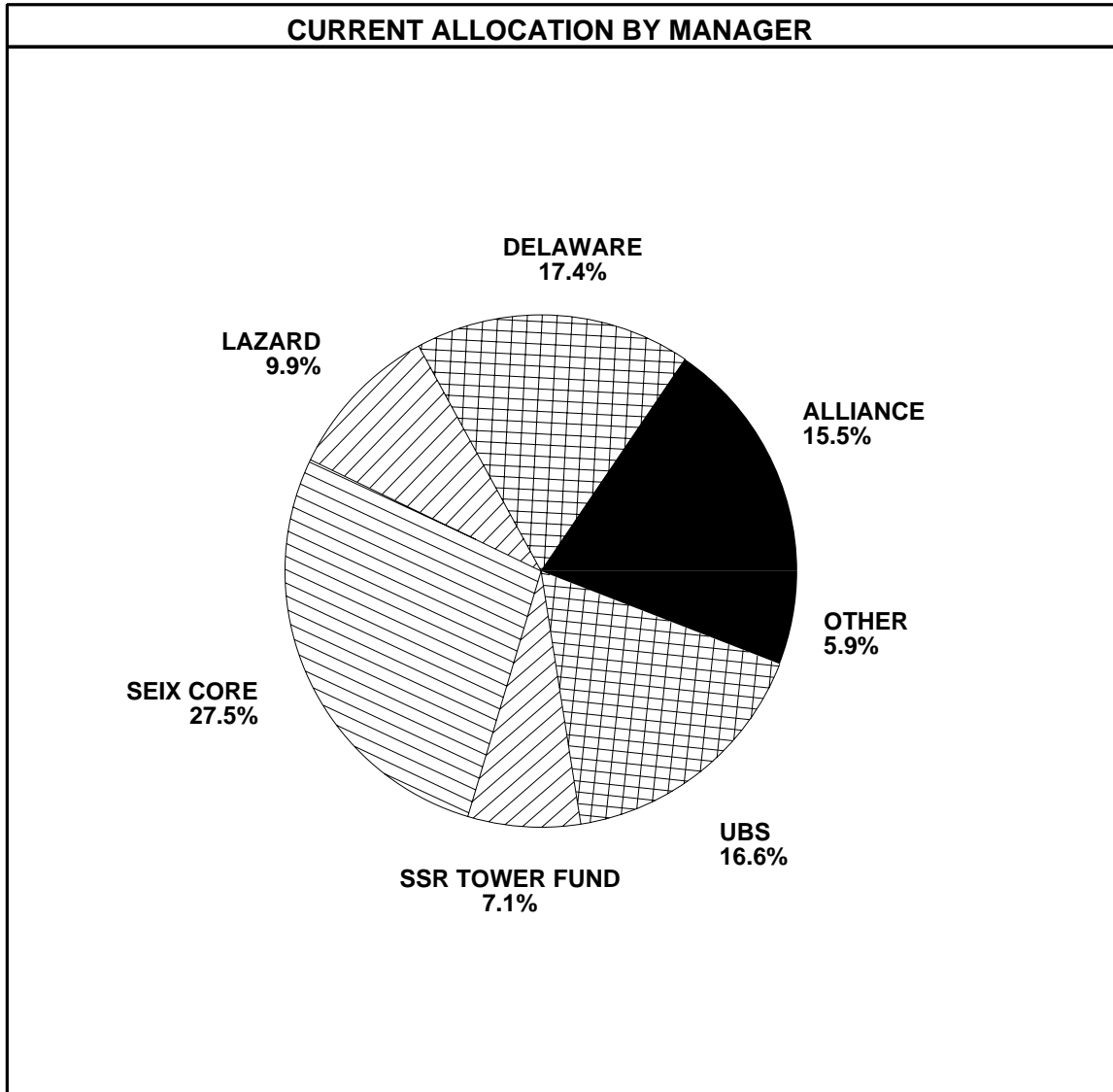

<u>MANAGER</u>	<u>CURRENT DOLLARS</u>	<u>CURRENT %</u>
ALLIANCE	0	0.0
ALLIANCE	37,115,764	15.5
ALT. ASSETS	740,729	0.3
DELAWARE	41,437,411	17.4
LAZARD	23,658,501	9.9
LOOMIS	0	0.0
SEIX CORE	65,697,950	27.5
SEIX HIGH YIELD	12,268,684	5.1
SSR TOWER FUND	17,002,951	7.1
UBS	39,723,228	16.6
VERMONT INVEST	<u>1,169,822</u>	<u>0.5</u>
TOTAL	238,815,040	100.0

**VERMONT MUNICIPAL EMPLOYEES
MANAGER ALLOCATION ANALYSIS
AS OF MARCH 31, 2005**

DOMESTIC EQUITY COMPOSITE

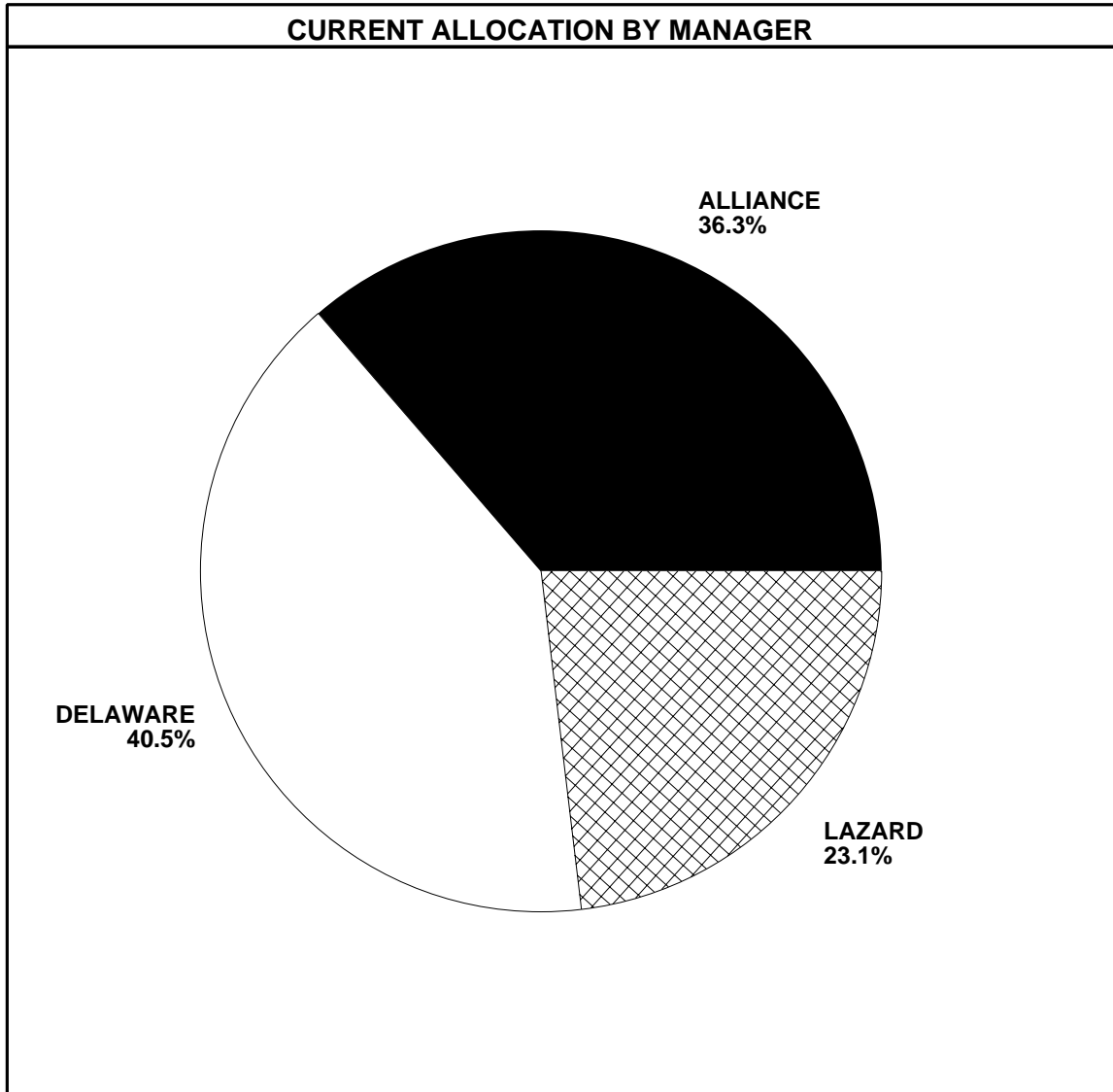

MANAGER	CURRENT DOLLARS	CURRENT %
ALLIANCE	37,115,764	36.3
DELAWARE	41,437,411	40.5
LAZARD	23,658,501	23.1
TOTAL	102,211,676	100.0

VERMONT MUNICIPAL EMPLOYEES

TOTAL FUNDS - EQUITY COMMITMENT

ASSET ALLOCATION HISTORY

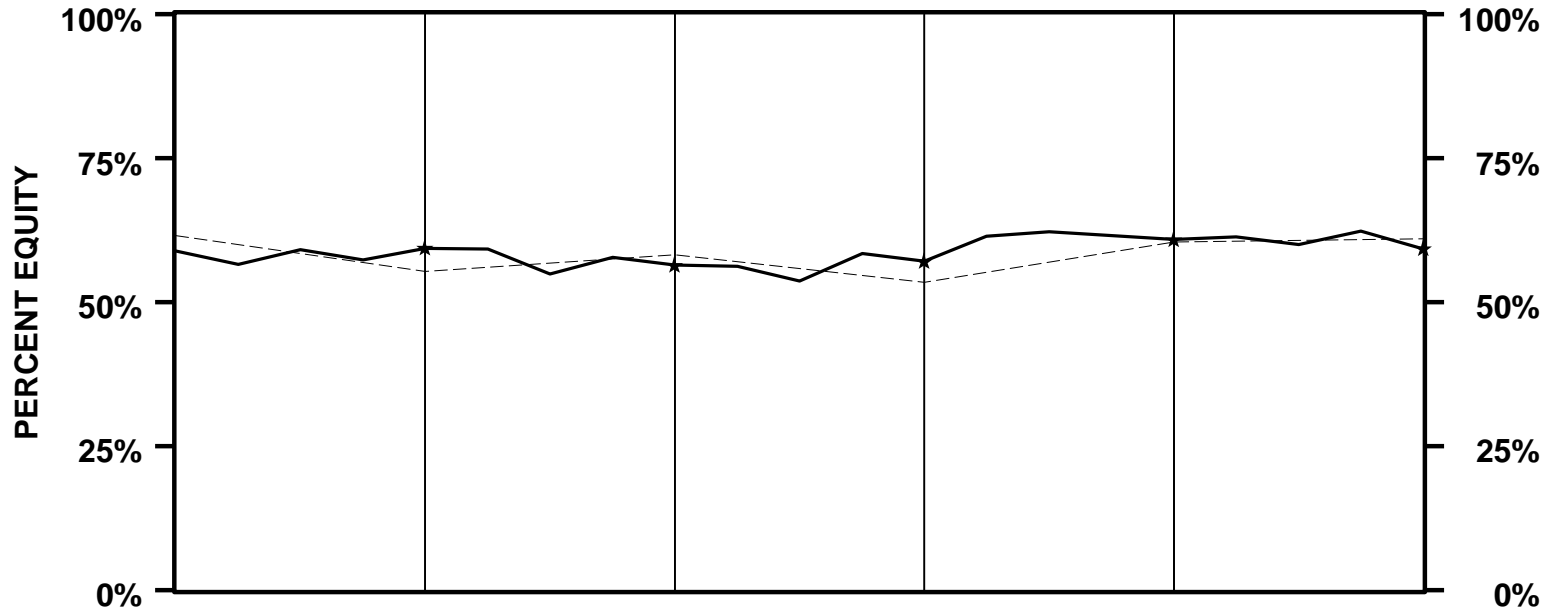

	3/00	3/01	3/02	3/03	3/04	3/05
HIGH	87.3	81.9	81.8	79.3	81.9	80.5
1ST QTL	69.4	63.7	65.6	61.7	67.5	68.1
■ MEDIAN	61.6	55.4	58.2	53.5	60.5	61.0
3RD QTL	49.0	41.5	44.9	42.5	48.9	50.8
LOW	0.0	0.0	0.0	0.0	0.0	0.0
★ MUNI COMPOSITE	58.9	58	56.5	57.1	60.9	59.3

* Includes International Segment

VERMONT MUNICIPAL EMPLOYEES

TOTAL FUNDS - BOND COMMITMENT

ASSET ALLOCATION HISTORY

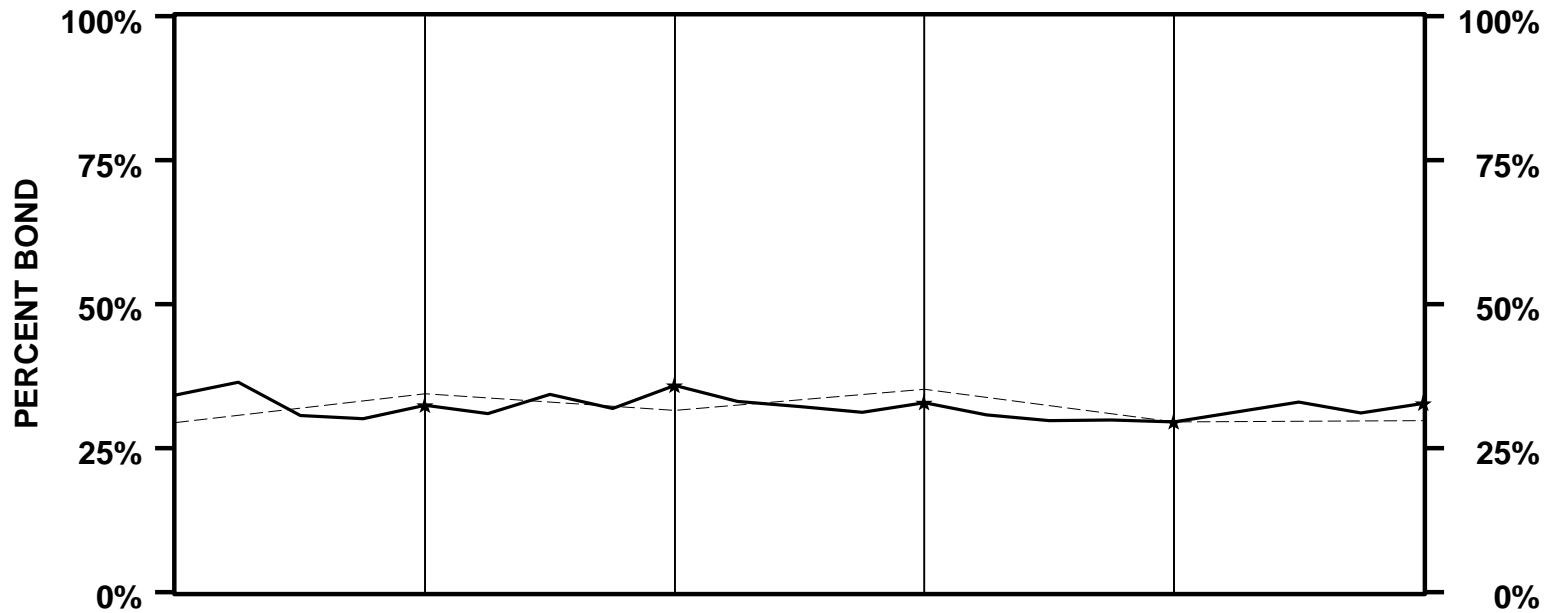

	3/00	3/01	3/02	3/03	3/04	3/05
HIGH	77.1	76.9	73.3	77.8	75.9	79.6
1ST QTL	38.5	43.0	39.7	44.8	38.1	38.1
■ MEDIAN	29.5	34.5	31.6	35.2	29.6	29.8
3RD QTL	19.1	22.8	21.7	25.9	20.8	21.3
LOW	0.0	0.0	0.0	0.0	0.0	1.7
★ MUNI COMPOSITE	34.2	32.4	35.9	32.9	29.6	32.8

* Includes International Segment

VERMONT MUNICIPAL EMPLOYEES

EQUITY FUNDS - EQUITY COMMITMENT

ASSET ALLOCATION HISTORY

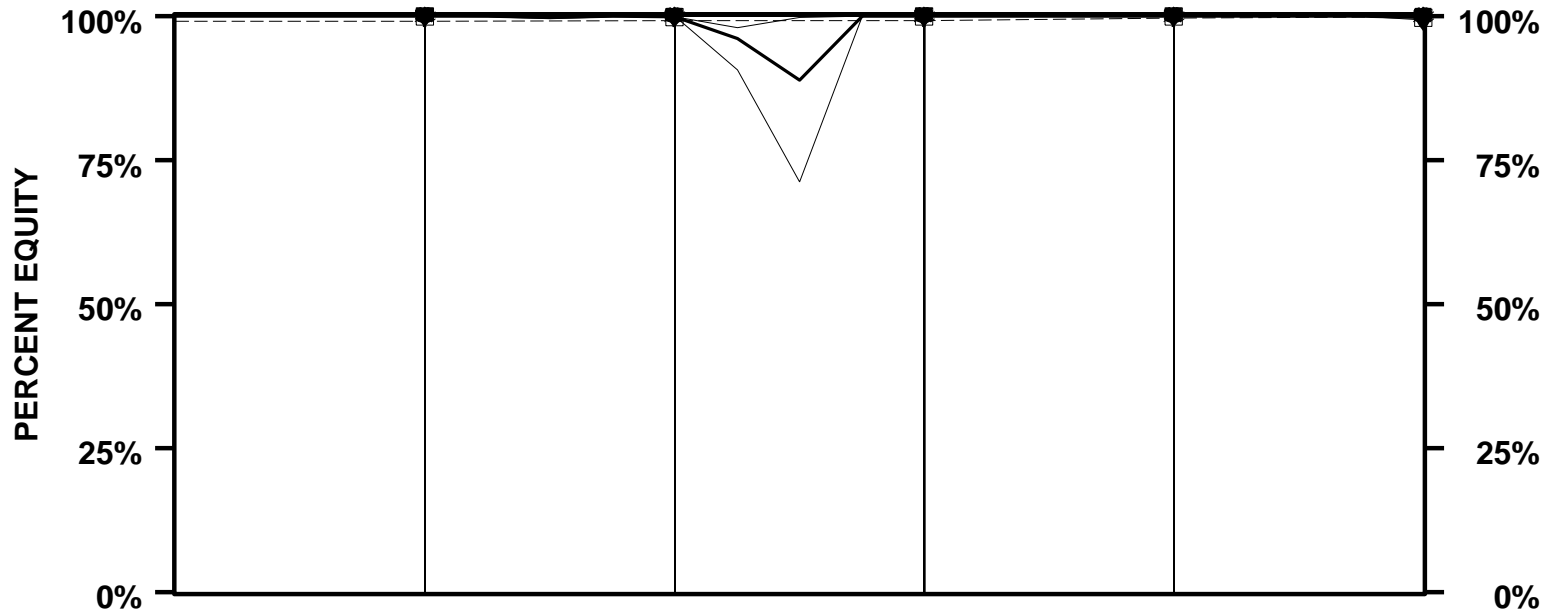

	3/00	3/01	3/02	3/03	3/04	3/05
HIGH	100.0	100.0	100.0	100.0	100.0	100.0
1ST QTL	100.0	100.0	100.0	100.0	100.0	100.0
MEDIAN	99.2	99.2	99.3	99.3	99.7	99.9
3RD QTL	95.8	95.5	96.0	96.0	97.3	97.3
LOW	0.0	0.0	45.6	52.0	68.6	84.4
EQTY COMPOSITE	100.0	100.0	99.9	100.0	100.0	99.8
DELAWARE	100.0	100.0	99.9	100.0	100.0	99.4
ALLIANCE	100.0	100.0	100.0	100.0	100.0	100.0
LAZARD	100.0	100.0	100.0	100.0	100.0	100.0
UBS	100.0	100.0	100.0	100.0	100.0	100.0

* Includes International Segment

VERMONT MUNICIPAL EMPLOYEES

BOND FUNDS - BOND COMMITMENT

ASSET ALLOCATION HISTORY

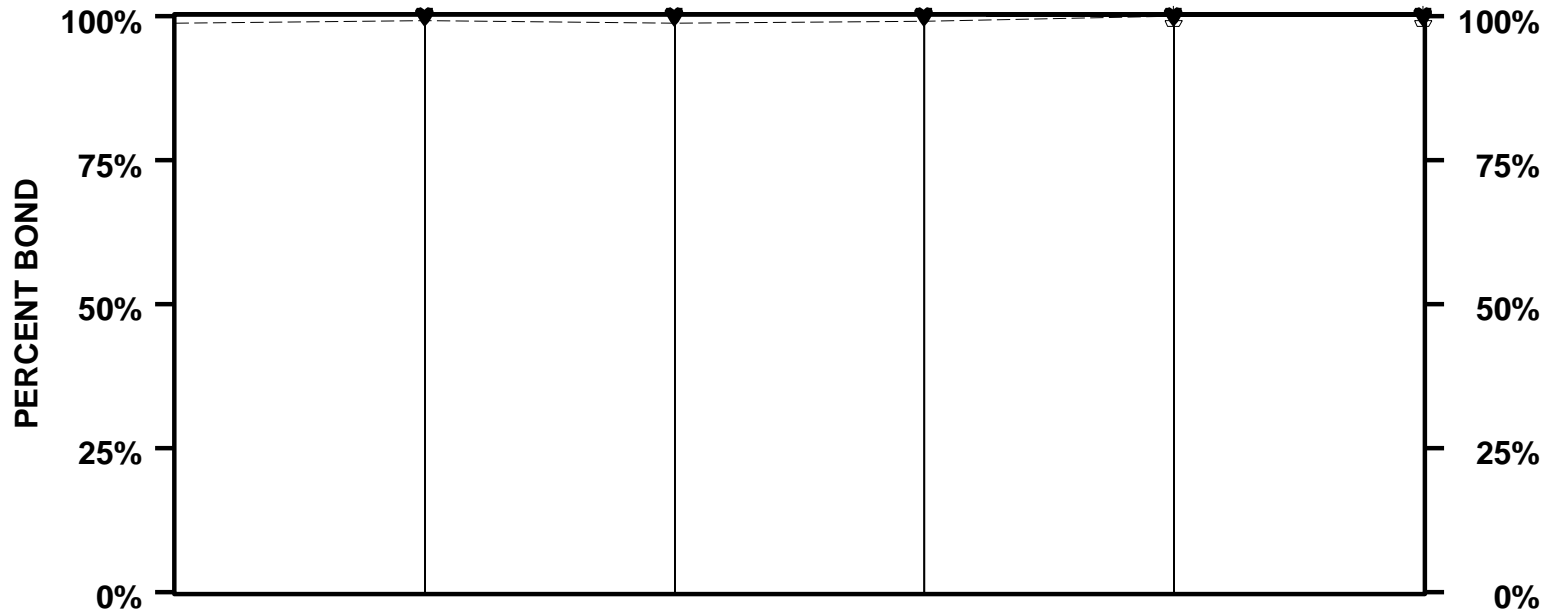

	<u>3/00</u>	<u>3/01</u>	<u>3/02</u>	<u>3/03</u>	<u>3/04</u>	<u>3/05</u>				
HIGH	100.0	100.0	100.0	100.0	100.0	100.0				
1ST QTL	100.0	100.0	100.0	100.0	100.0	100.0				
■ MEDIAN	98.8	99.3	98.8	99.2	100.0	100.0				
3RD QTL	92.3	94.2	92.4	92.3	95.7	96.9				
LOW	0.0	0.0	0.0	0.0	0.0	36.2				
♥ SEIX CORE	100.0	1	100.0	1	100.0	1	100.0	1	100.0	1
⚡ SEIX HIGH YIELD					100.0	1	100.0	1		

* Includes International Segment

VERMONT MUNICIPAL EMPLOYEES

PERFORMANCE SUMMARY

PERIODS ENDING 3/05

	<u>LAST QTR</u>		<u>LAST 2 QTRS</u>		<u>LAST 3 QTRS</u>		<u>LAST YEAR</u>		<u>LAST 3 YEARS</u>		<u>LAST 5 YEARS</u>	
** TOTAL FUND **												
MUNI COMPOSITE	- 1.4	76	5.6	64	5.6	65	6.0	58	6.1	58	4.2	36
ALLOC INDEX	- 1.5	79	6.4	48	6.8	42	6.8	42	7.1	34	2.2	73
POLICY INDEX	- 1.3	72	6.1	55	6.7	44	6.8	44	6.9	38	2.7	67
MEDIAN	- 0.9		6.4		6.4		6.5		6.4		3.5	
** EQUITY MANAGERS **												
EQTY COMPOSITE	- 3.3	74	6.1	79	2.7	78	4.6	75	2.8	76	0.9	50
DELAWARE	- 1.3	36	7.3	61	6.1	47	8.1	43	5.0	48	7.0	31
ALLIANCE	- 6.2	92	2.5	94	- 3.4	96	- 1.7	96	- 2.5	99	- 10.1	95
LAZARD	- 1.8	46	9.9	33	6.9	41	8.7	39	7.2	33	11.9	19
S&P 500	- 2.1	57	6.9	71	4.9	63	6.7	61	2.8	76	- 3.2	73
R 1000(R) GR	- 4.1	81	4.7	86	- 0.8	91	1.2	88	- 0.7	92	- 11.3	97
R 1000(R) VALUE	0.1	19	10.5	27	12.2	14	13.2	18	7.2	34	5.2	37
R 2000(R)	- 5.3	89	8.0	53	4.9	62	5.4	71	8.0	29	4.0	41
MEDIAN	- 2.0		8.4		5.7		7.3		4.8		0.9	

VERMONT MUNICIPAL EMPLOYEES

PERFORMANCE SUMMARY

PERIODS ENDING 3/05

	<u>LAST QTR</u>		<u>LAST 2 QTRS</u>		<u>LAST 3 QTRS</u>		<u>LAST YEAR</u>		<u>LAST 3 YEARS</u>		<u>LAST 5 YEARS</u>	
** BOND MANAGERS **												
SEIX CORE	- 0.3	44	0.6	60	4.2	42	2.1	40	6.0	61	7.0	63
SEIX HIGH YIELD	- 1.5	93	1.5	18	6.5	7	5.0	7				
LB AGGREGATE	- 0.5	66	0.5	70	3.7	58	1.2	69	6.0	60	7.1	56
ML HIGH YLD II	- 1.4	93	3.0	4	7.8	3	6.9	2	10.5	2	6.7	72
MEDIAN	- 0.3		0.9		3.9		1.8		6.4		7.3	
** CASH EQUIV MANAGERS **												
VERMONT INVEST	1.8	1	2.9	3	3.7	3	3.4	4	2.7	9	3.9	9
90 DAY T-BILLS	0.6	27	1.1	22	1.4	23	1.7	22	1.5	43	2.8	48
MEDIAN	0.5		1.0		1.3		1.5		1.4		2.8	
** INT'L DEVELOPED MKT EQUITY MANAGERS **												
UBS	- 0.4	76	13.9	75	15.7	36	15.5	41	11.6	50	3.4	43
MS EAFE NET	- 0.2	68	15.1	41	14.8	57	15.1	47	11.6	46	- 1.1	77
CITI PMI EPAC	- 0.1	67	15.4	34	15.3	40	15.2	47	11.9	45	- 0.6	71
MEDIAN	0.2		14.8		14.9		14.8		11.6		2.0	

VERMONT MUNICIPAL EMPLOYEES

PERFORMANCE SUMMARY

PERIODS ENDING 3/05

	<u>LAST QTR</u>		<u>LAST 2 QTRS</u>		<u>LAST 3 QTRS</u>		<u>LAST YEAR</u>		<u>LAST 3 YEARS</u>		<u>LAST 5 YEARS</u>	
** REAL ESTATE MANAGERS **												
SSR TOWER FUND	4.1	20	6.6	50	6.8	69	9.9	67	6.6	67	6.9	72
NCREIF CL PROP	0.0	61	3.8	71	7.3	68	10.4	60	7.8	63	8.4	59
MEDIAN	1.0		6.7		10.3		11.9		10.0		9.4	
** PRIVATE EQUITY MANAGERS **												
ALT. ASSETS	0.1	38	-18.6	97	-18.6	95	-18.6	89	-15.5	94	0.0	48
MEDIAN	0.0		1.2		2.7		5.7		4.5		0.0	

VERMONT MUNICIPAL EMPLOYEES

PERFORMANCE SUMMARY NET OF FEES

PERIODS ENDING 3/05

	LAST QTR	LAST 2 QTRS	LAST 3 QTRS	LAST YEAR	LAST 3 YEARS	LAST 5 YEARS
** TOTAL FUND **						
MUNI COMPOSITE	- 1.4	5.5	5.5	5.8	5.9	
ALLOC INDEX	- 1.5	6.4	6.8	6.8	7.1	2.2
POLICY INDEX	- 1.3	6.1	6.7	6.8	6.9	2.7
** EQUITY MANAGERS **						
EQTY COMPOSITE	- 3.3	6.0	2.6	4.4	2.5	
DELAWARE	- 1.3	7.3	6.1	8.1	5.0	
ALLIANCE	- 6.2	2.5	- 3.4	- 1.7	- 2.5	
LAZARD	- 2.0	9.5	6.3	7.9	6.4	
S&P 500	- 2.1	6.9	4.9	6.7	2.8	- 3.2
R 1000(R) GR	- 4.1	4.7	- 0.8	1.2	- 0.7	- 11.3
R 1000(R) VALUE	0.1	10.5	12.2	13.2	7.2	5.2
R 2000(R)	- 5.3	8.0	4.9	5.4	8.0	4.0
** BOND MANAGERS **						
SEIX CORE	- 0.3	0.6	4.2	2.1	6.0	
SEIX HIGH YIELD	- 1.6	1.2	6.1	4.4		
LB AGGREGATE	- 0.5	0.5	3.7	1.2	6.0	7.1
ML HIGH YLD II	- 1.4	3.0	7.8	6.9	10.5	6.7
** CASH EQUIV MANAGERS **						
VERMONT INVEST	1.8	2.9	3.7	3.4	2.7	

VERMONT MUNICIPAL EMPLOYEES

PERFORMANCE SUMMARY NET OF FEES

PERIODS ENDING 3/05

	<u>LAST QTR</u>	<u>LAST 2 QTRS</u>	<u>LAST 3 QTRS</u>	<u>LAST YEAR</u>	<u>LAST 3 YEARS</u>	<u>LAST 5 YEARS</u>
** CASH EQUIV MANAGERS **						
<i>90 DAY T-BILLS</i>	0.6	1.1	1.4	1.7	1.5	2.8
** INT'L DEVELOPED MKT EQUITY MANAGERS **						
UBS	- 0.4	13.9	15.7	15.5	11.6	
<i>MS EAFE NET</i>	- 0.2	15.1	14.8	15.1	11.6	- 1.1
<i>CITI PMI EPAC</i>	- 0.1	15.4	15.3	15.2	11.9	- 0.6
** REAL ESTATE MANAGERS **						
SSR TOWER FUND	4.1	6.3	6.2	8.9	5.7	
<i>NCREIF CL PROP</i>	0.0	3.8	7.3	10.4	7.8	8.4
** PRIVATE EQUITY MANAGERS **						
ALT. ASSETS	0.1	- 18.6	- 18.6	- 18.6	- 15.5	

VERMONT MUNICIPAL EMPLOYEES

TOTAL FUNDS - TOTAL RATES OF RETURN

PERIODS ENDING 3/05

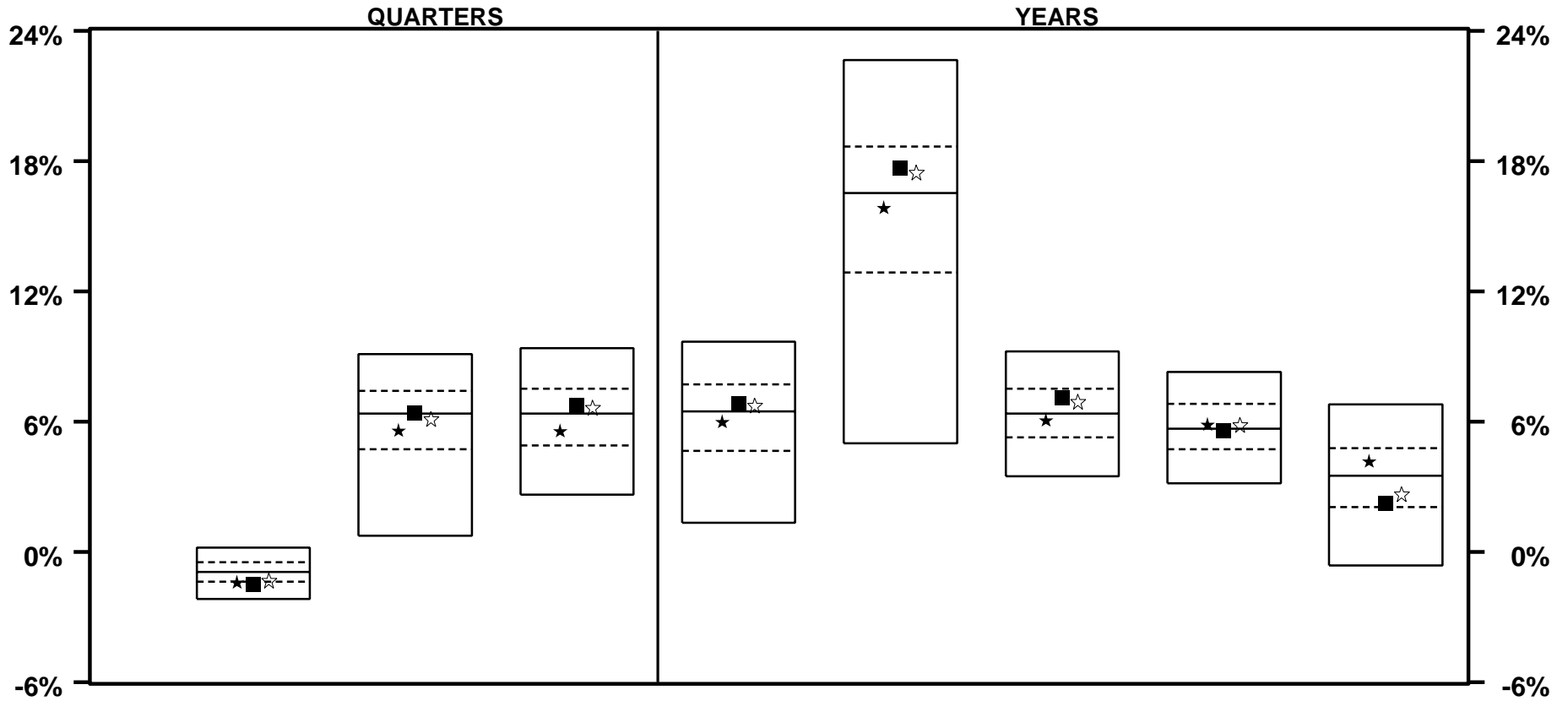

	LAST QTR		LAST 2 QTRS		LAST 3 QTRS		LAST YEAR		LAST 2 YEARS		LAST 3 YEARS		LAST 4 YEARS		LAST 5 YEARS	
★ MUNI COMPOSITE	-1.4	76	5.6	64	5.6	65	6.0	58	15.8	57	6.1	58	5.9	45	4.2	36
■ ALLOC INDEX	-1.5	79	6.4	48	6.8	42	6.8	42	17.7	35	7.1	34	5.6	52	2.2	73
☆ POLICY INDEX	-1.3	72	6.1	55	6.7	44	6.8	44	17.5	37	6.9	38	5.9	45	2.7	67
MEDIAN	-0.9		6.4		6.4		6.5		16.5		6.4		5.7		3.5	

VERMONT MUNICIPAL EMPLOYEES

TOTAL FUNDS - TOTAL RATES OF RETURN

PERIODS ENDING 3/05

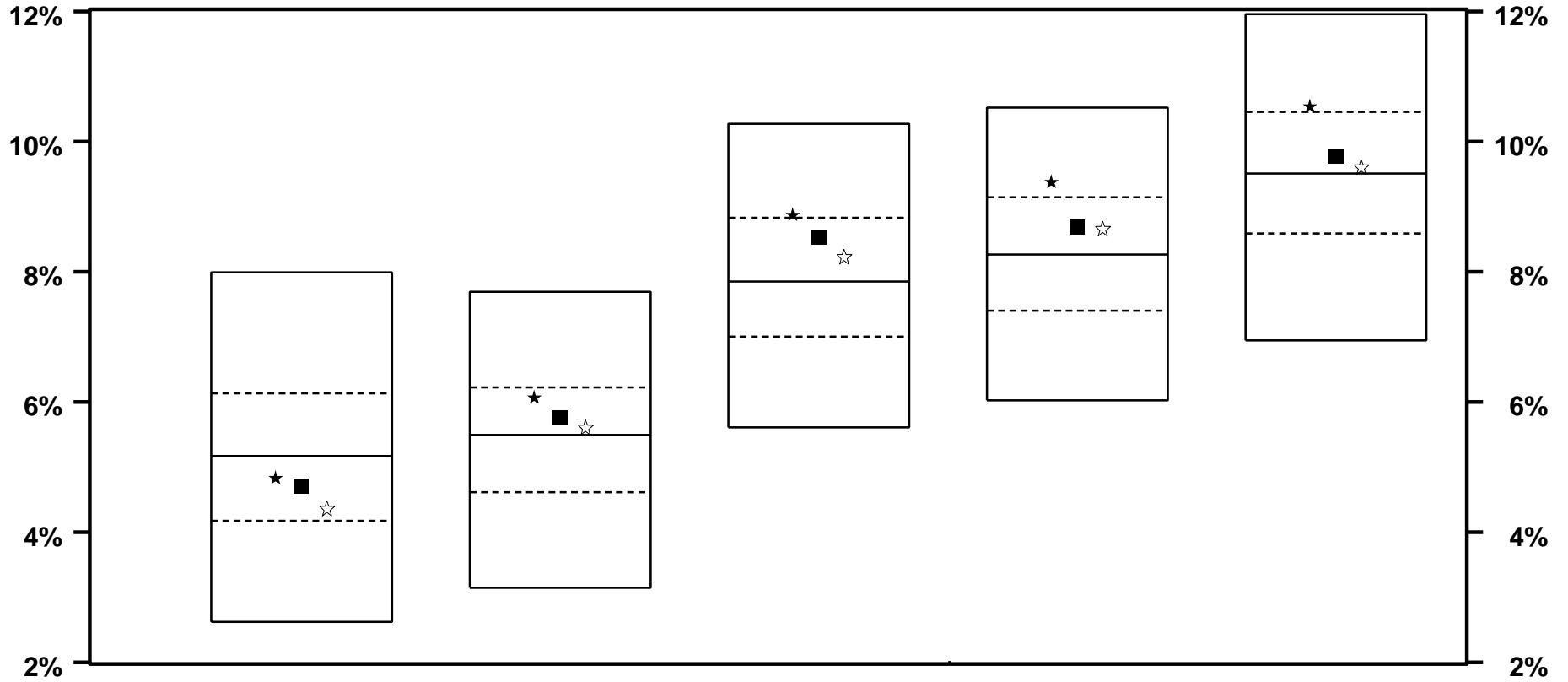

	LAST 6 YEARS		LAST 7 YEARS		LAST 8 YEARS		LAST 9 YEARS		LAST 10 YEARS	
★ MUNI COMPOSITE	4.8	58	6.1	28	8.9	23	9.4	19	10.5	22
■ ALLOC INDEX	4.7	63	5.8	39	8.5	34	8.7	38	9.8	41
☆ POLICY INDEX	4.4	71	5.6	43	8.2	40	8.7	38	9.6	46
MEDIAN	5.2		5.5		7.9		8.3		9.5	

VERMONT MUNICIPAL EMPLOYEES

TOTAL FUNDS - TOTAL RATES OF RETURN

YEARS ENDING

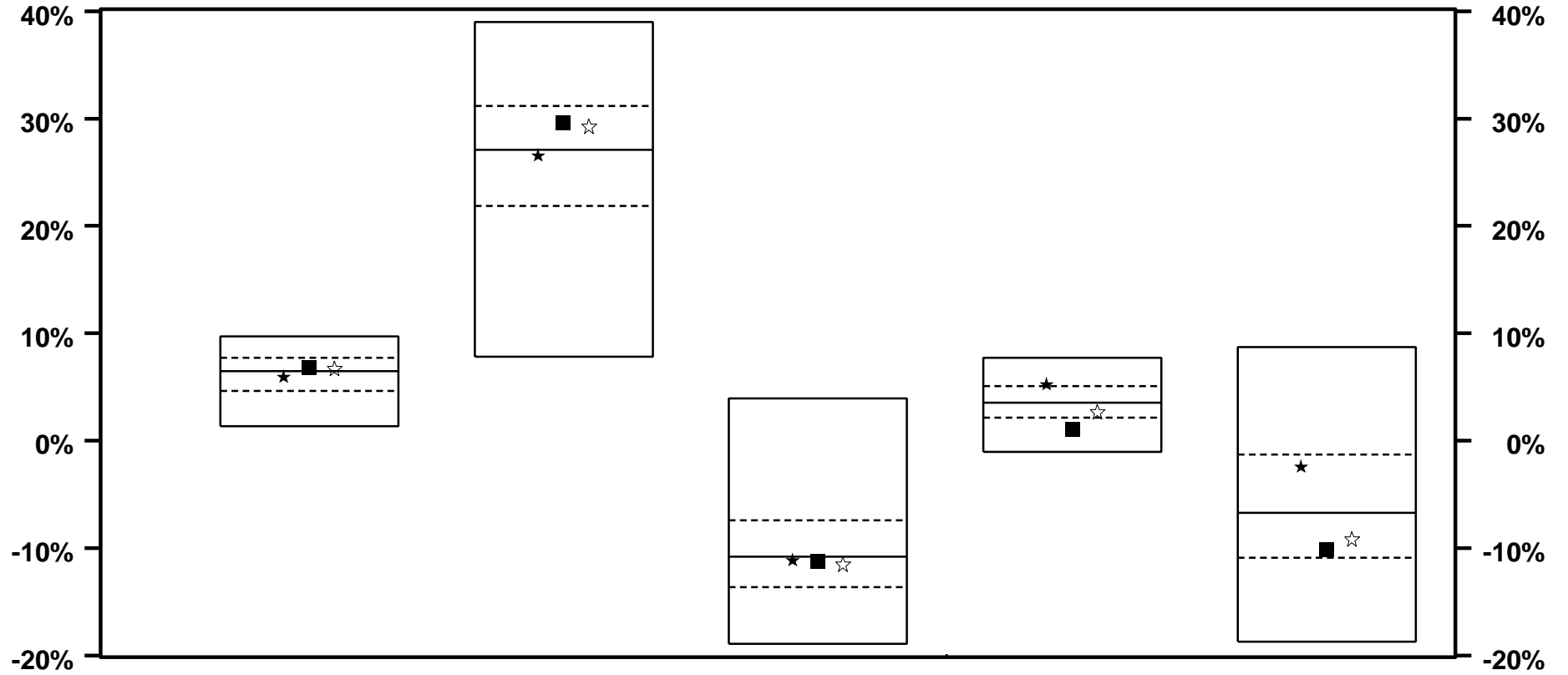

	3 / 05		3 / 04		3 / 03		3 / 02		3 / 01	
★ MUNI COMPOSITE	6.0	58	26.6	53	-11.1	52	5.3	22	-2.4	28
■ ALLOC INDEX	6.8	42	29.6	33	-11.3	54	1.1	87	-10.1	70
☆ POLICY INDEX	6.8	44	29.3	36	-11.4	55	2.7	65	-9.1	64
MEDIAN	6.5		27.1		-10.8		3.6		-6.7	

VERMONT MUNICIPAL EMPLOYEES

TOTAL FUNDS - TOTAL RATES OF RETURN

YEARS ENDING

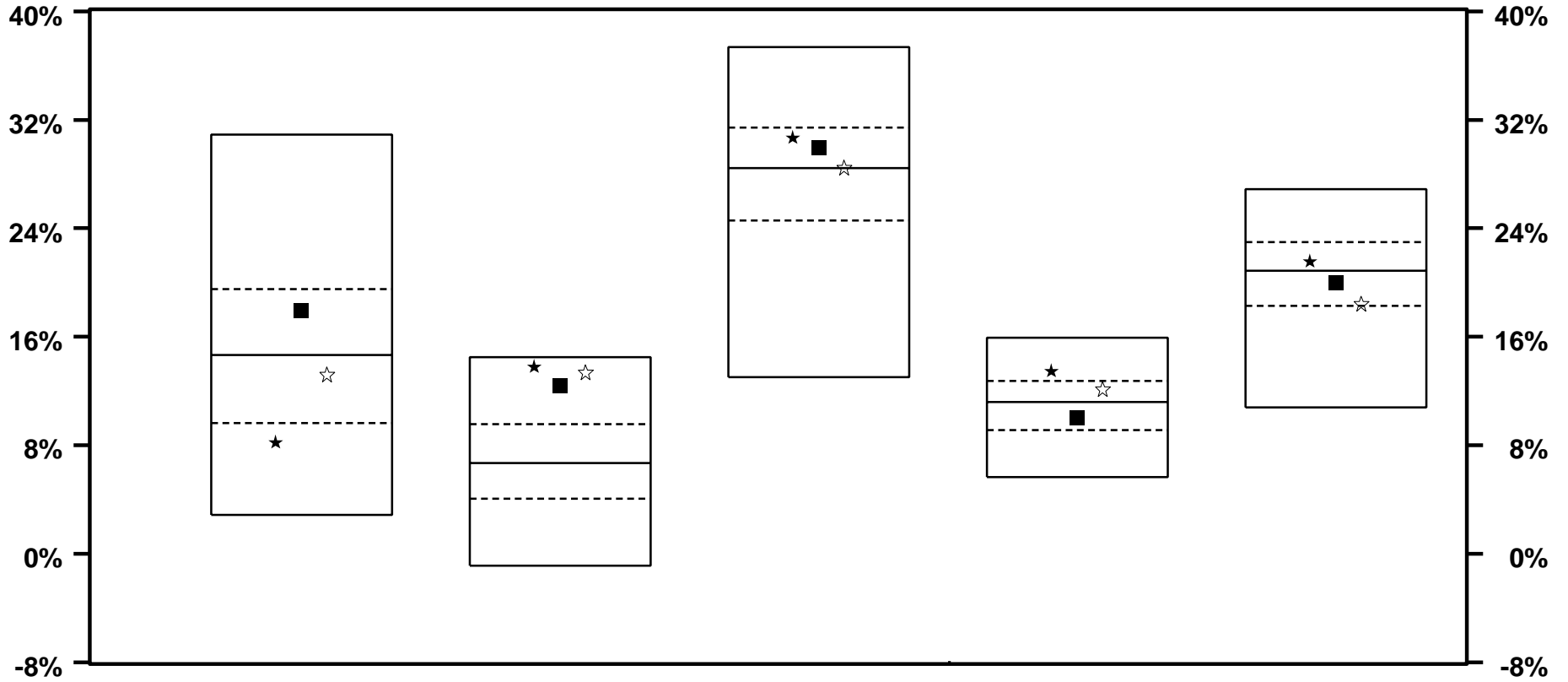

	3 / 00		3 / 99		3 / 98		3 / 97		3 / 96	
★ MUNI COMPOSITE	8.2	79	13.8	6	30.7	30	13.5	17	21.6	41
■ ALLOC INDEX	18.0	31	12.4	11	30.0	36	10.0	64	20.0	59
☆ POLICY INDEX	13.2	57	13.4	7	28.5	49	12.2	33	18.5	73
MEDIAN	14.7		6.7		28.4		11.2		20.9	

VERMONT MUNICIPAL EMPLOYEES

TOTAL FUNDS - TOTAL VS EQUITY ONLY RETURNS

MARKET CYCLE PERFORMANCE COMPARISONS

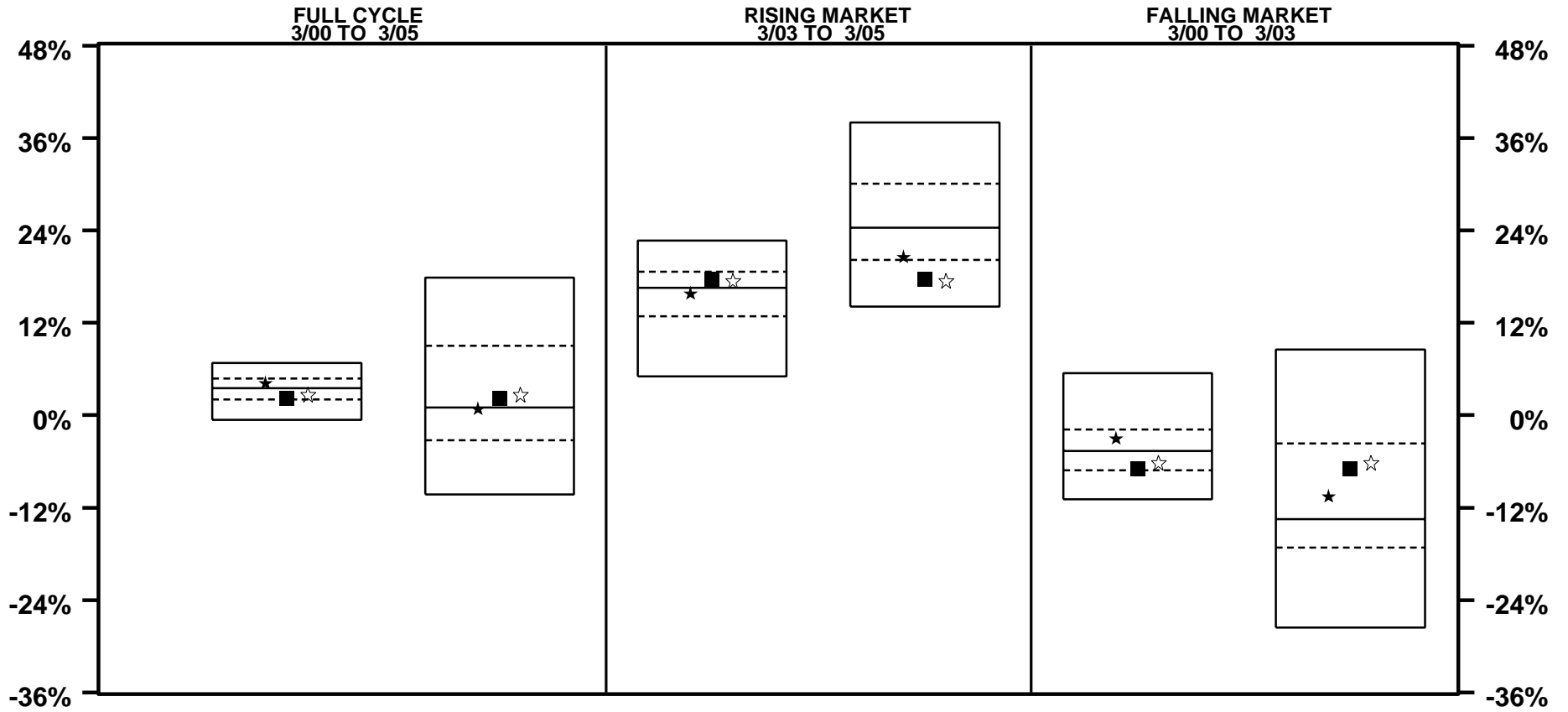

	TOTAL FUND		EQUITY ONLY		TOTAL FUND		EQUITY ONLY		TOTAL FUND		EQUITY ONLY	
★ MUNI COMPOSITE	4.2	36	0.8	50	15.8	57	20.5	70	-3.0	33	-10.5	42
■ ALLOC INDEX	2.2	73	2.2	46	17.7	35	17.7	89	-6.9	73	-6.9	32
☆ POLICY INDEX	2.7	67	2.7	44	17.5	37	17.5	89	-6.1	65	-6.1	30
MEDIAN	3.5		1.0		16.5		24.4		-4.6		-13.5	

VERMONT MUNICIPAL EMPLOYEES

TOTAL FUNDS - TOTAL VS BOND ONLY RETURNS

MARKET CYCLE PERFORMANCE COMPARISONS

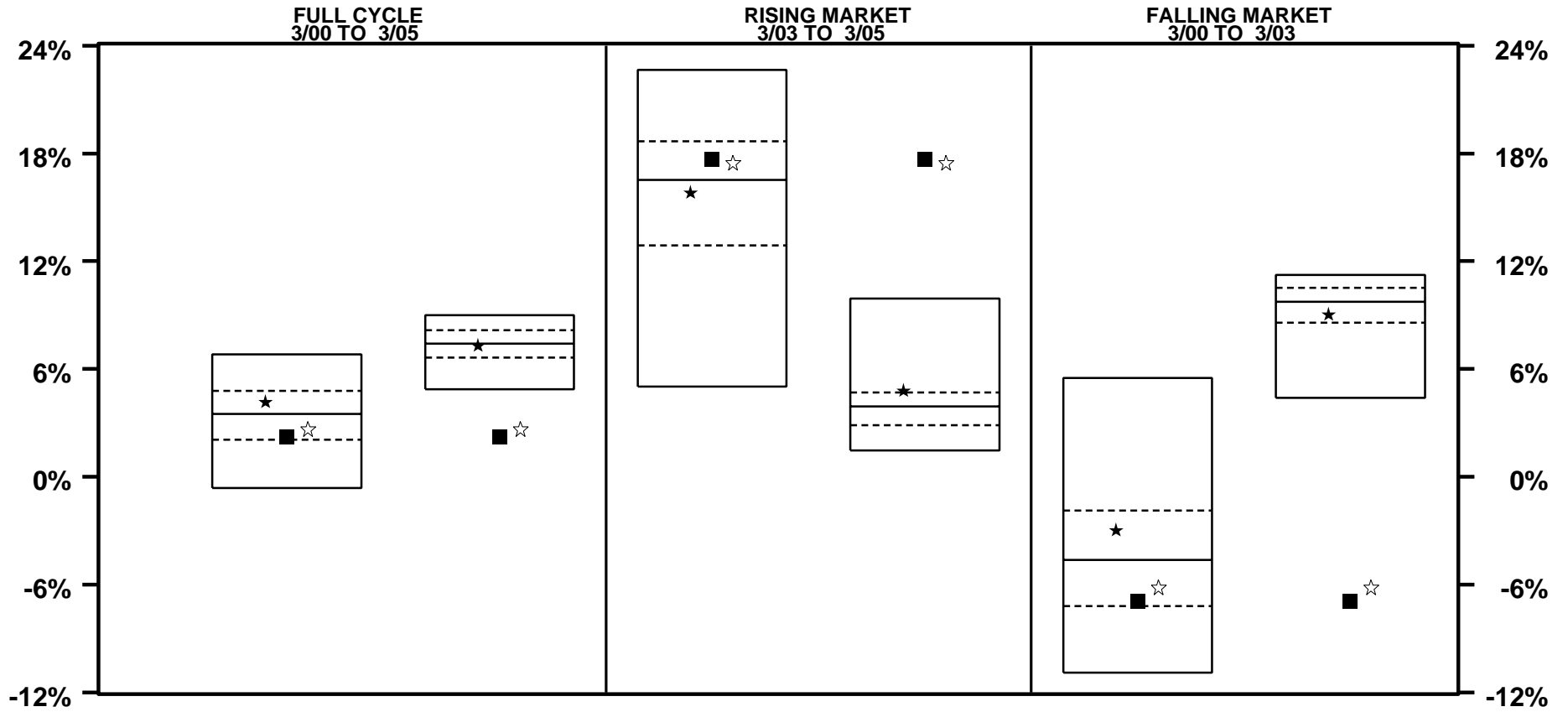

	TOTAL FUND		BONDS ONLY		TOTAL FUND		BONDS ONLY		TOTAL FUND		BONDS ONLY	
★ MUNI COMPOSITE	4.2	36	7.3	52	15.8	57	4.8	22	-3.0	33	9.0	67
■ ALLOC INDEX	2.2	73	2.2	99	17.7	35	17.7	1	-6.9	73	-6.9	99
☆ POLICY INDEX	2.7	67	2.7	99	17.5	37	17.5	1	-6.1	65	-6.1	99
MEDIAN	3.5		7.4		16.5		3.9		-4.6		9.7	

VERMONT MUNICIPAL EMPLOYEES

TOTAL FUNDS - TOTAL RATES OF RETURN

EFFECTS OF EQUITY ALLOCATION ON RATE OF RETURN

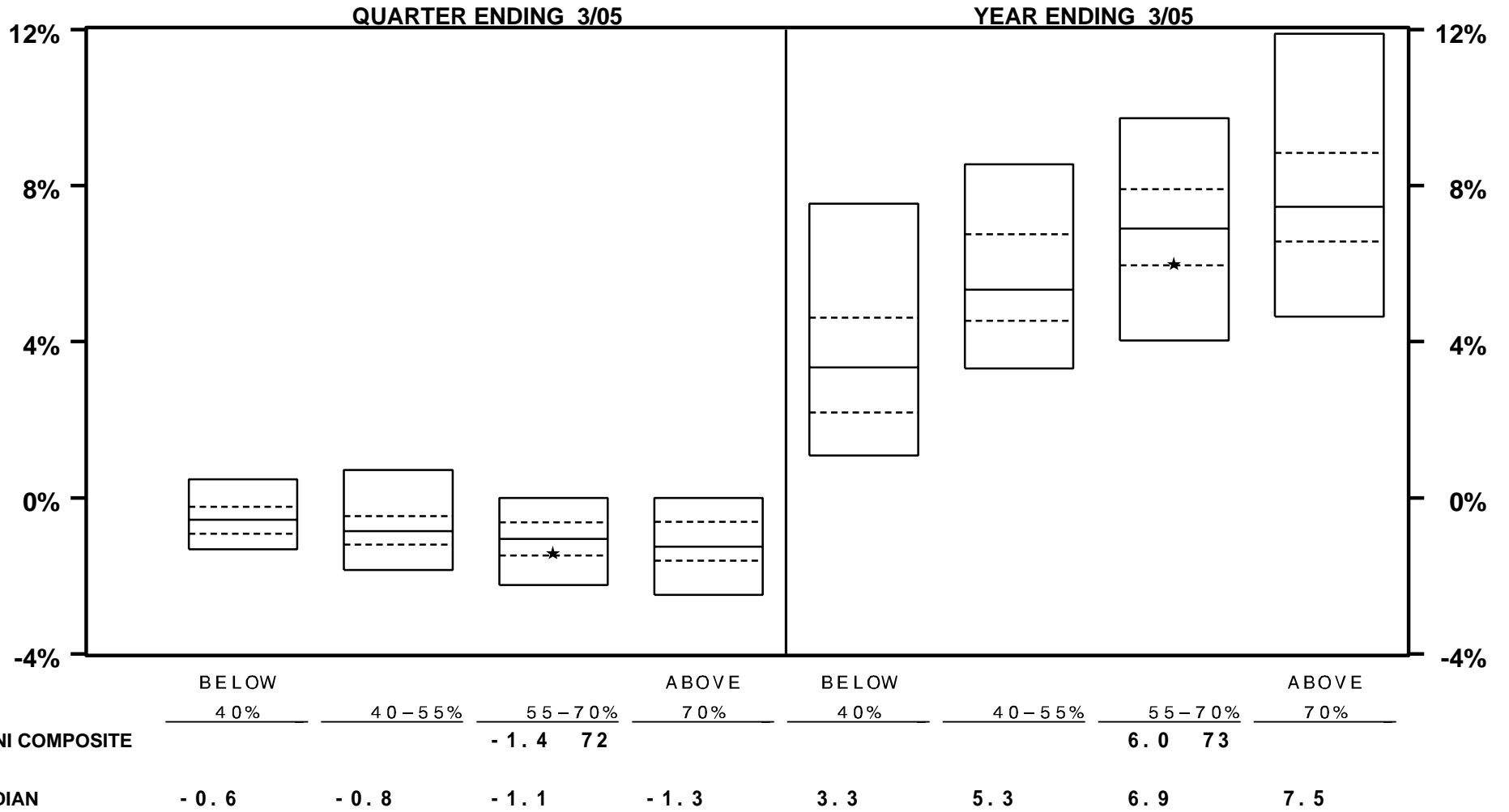

VERMONT MUNICIPAL EMPLOYEES

TOTAL FUNDS - TOTAL RATES OF RETURN

EFFECTS OF EQUITY ALLOCATION ON RATE OF RETURN

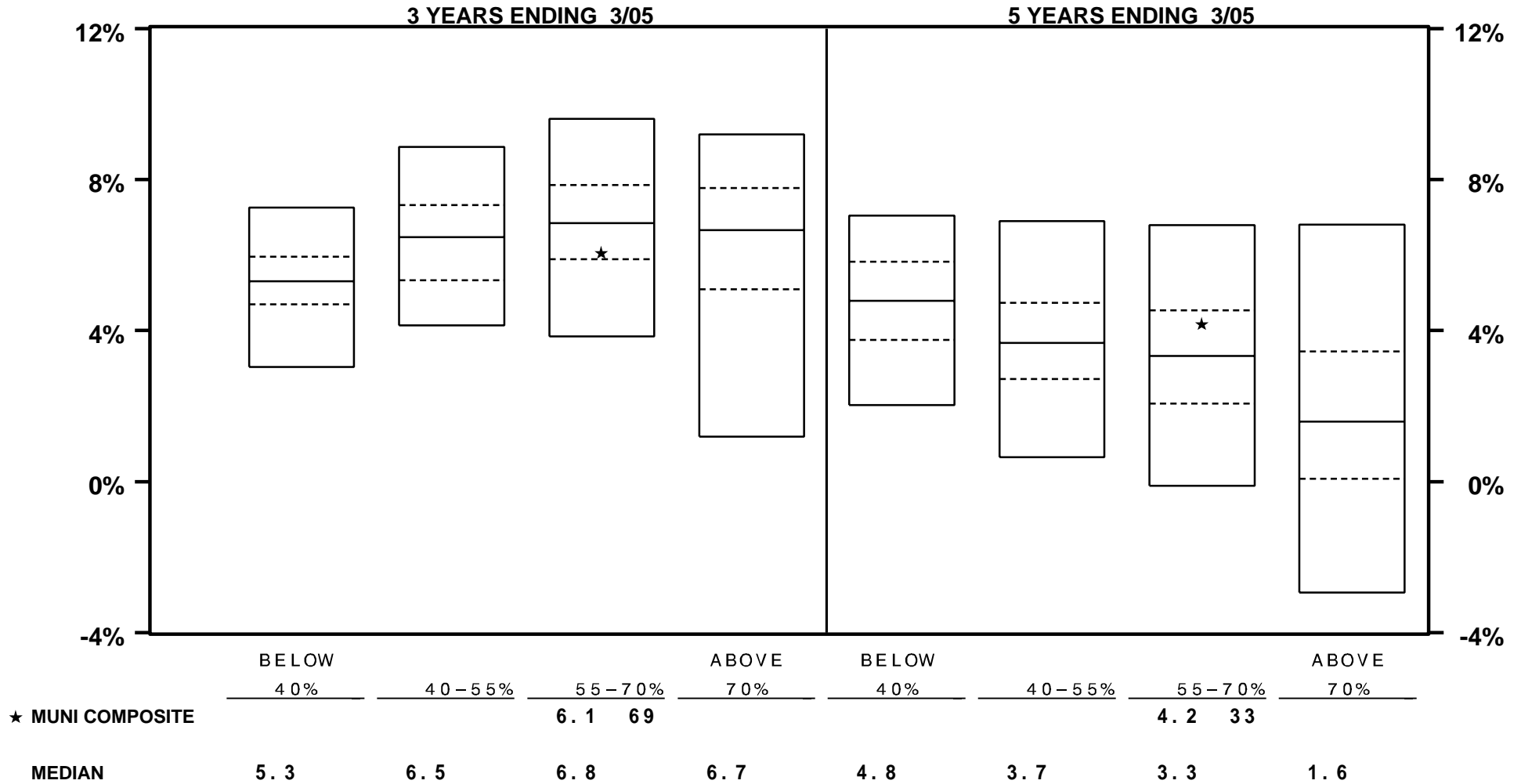

VERMONT MUNICIPAL EMPLOYEES

TOTAL FUNDS - TOTAL FUND INCOME RATES OF RETURN FOR PERIOD ENDING 3/05

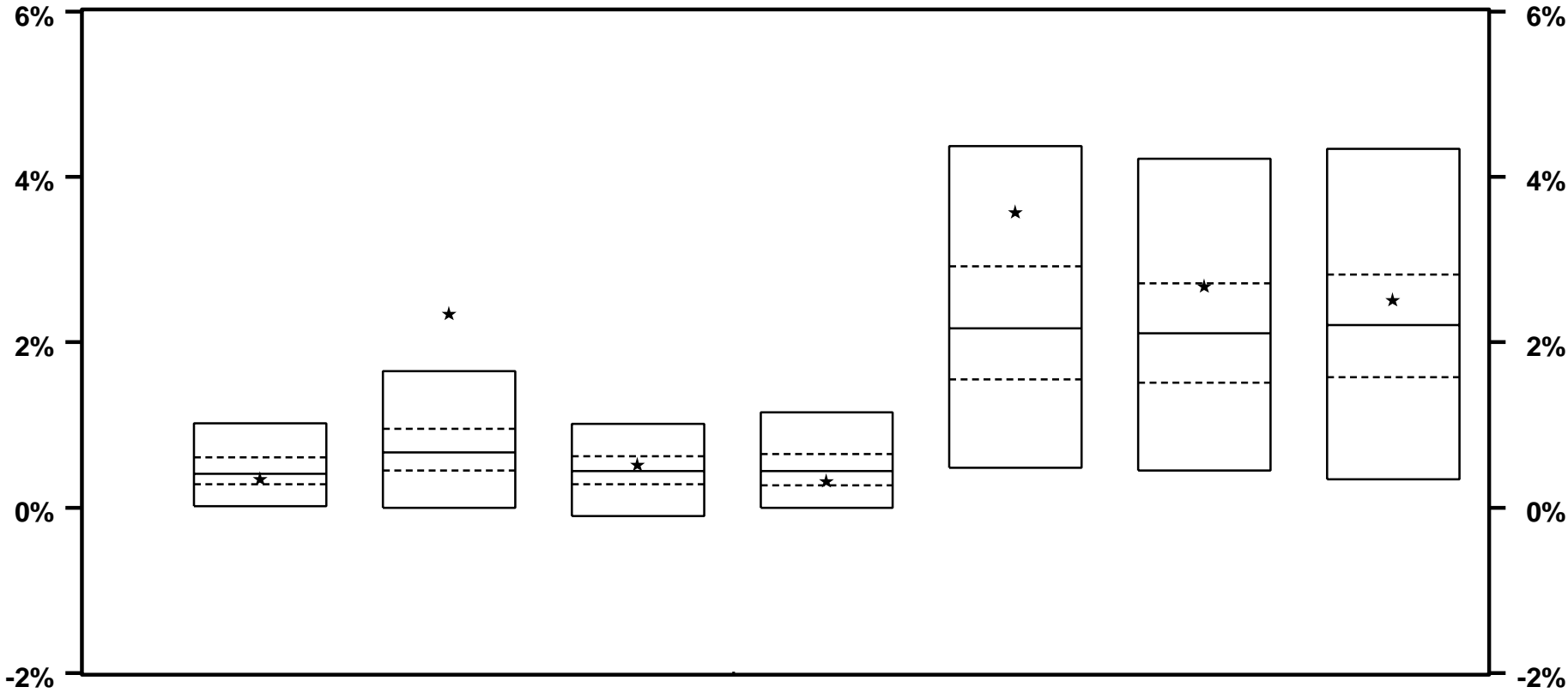

	<u>THIS</u> <u>QUARTER</u>	<u>LAST</u> <u>QUARTER</u>	<u>2 QTRS</u> <u>AGO</u>	<u>3 QTRS</u> <u>AGO</u>	<u>LAST</u> <u>YEAR</u>	<u>LAST</u> <u>2 YEARS</u>	<u>LAST</u> <u>3 YEARS</u>
★ MUNI COMPOSITE	0.3 60	2.3 1	0.5 37	0.3 66	3.6 13	2.7 25	2.5 38
MEDIAN	0.4	0.7	0.4	0.4	2.2	2.1	2.2

VERMONT MUNICIPAL EMPLOYEES

TOTAL FUNDS - TOTAL RETURN VS RISK

3 YEARS ENDING 3/05

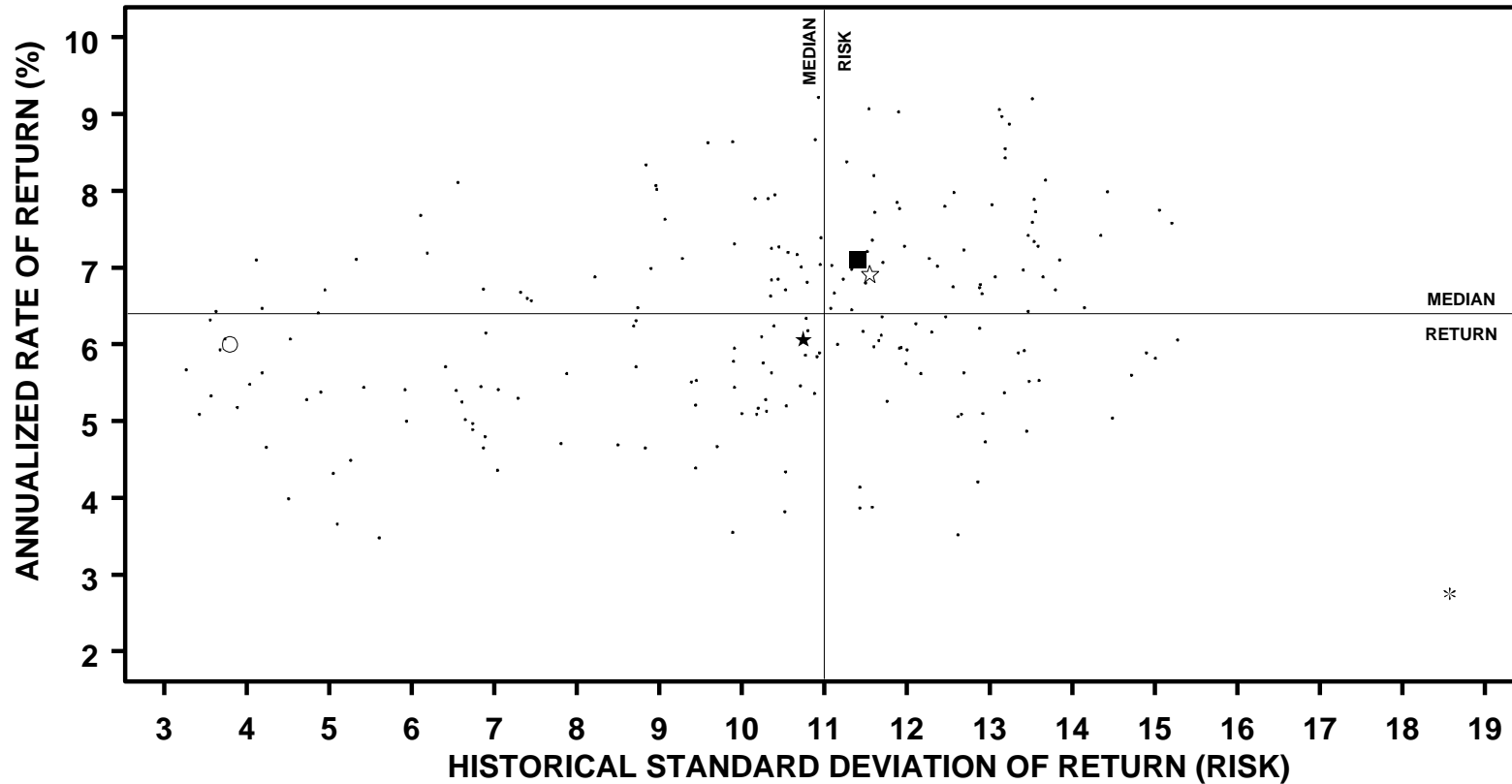

	ANNUALIZED RETURN		STANDARD DEVIATION		SHARPE RATIO	
	VALUE	RANK	VALUE	RANK	VALUE	RANK
★ MUNI COMPOSITE	6.1	58	10.8	54	0.5	61
■ ALLOC INDEX	7.1	34	11.4	42	0.5	47
☆ POLICY INDEX	6.9	38	11.6	40	0.5	51
* S&P 500	2.8	97	18.6	1	0.2	97
○ LB AGGREGATE	6.0	60	3.8	92	1.2	4
MEDIAN	6.4		11.0		0.5	

VERMONT MUNICIPAL EMPLOYEES

TOTAL FUNDS - TOTAL RETURN VS RISK

5 YEARS ENDING 3/05

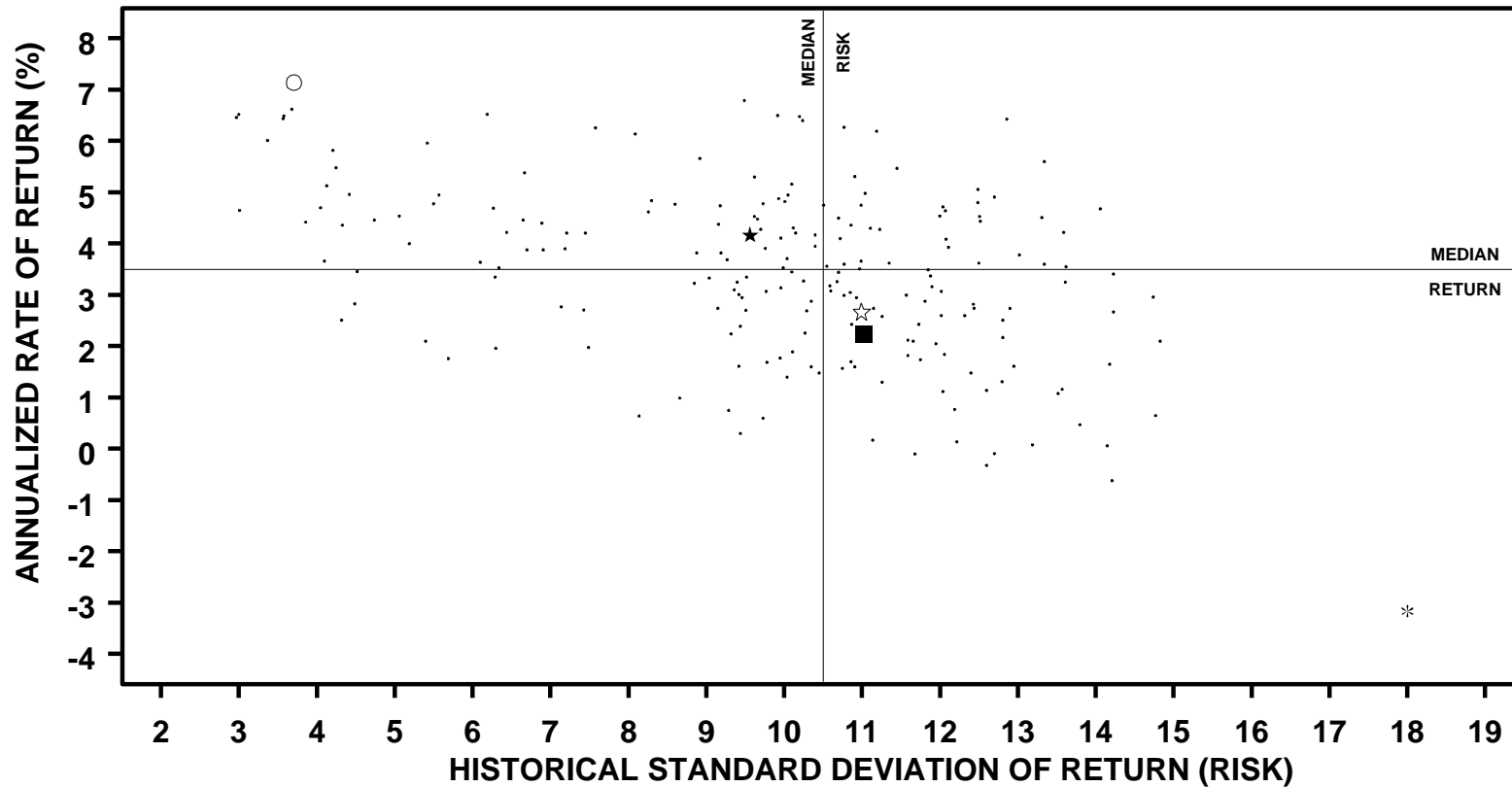

	ANNUALIZED RETURN		STANDARD DEVIATION		SHARPE RATIO	
	VALUE	RANK	VALUE	RANK	VALUE	RANK
★ MUNI COMPOSITE	4.2	36	9.6	66	0.2	35
■ ALLOC INDEX	2.2	73	11.0	39	0.0	71
☆ POLICY INDEX	2.7	67	11.0	39	0.0	65
* S&P 500	-3.2	99	18.0	1	-0.2	
○ LB AGGREGATE	7.1	2	3.7	91	1.1	1
MEDIAN	3.5		10.5		0.1	

VERMONT MUNICIPAL EMPLOYEES

EQUITY FUNDS - TOTAL RATES OF RETURN

PERIODS ENDING 3/05

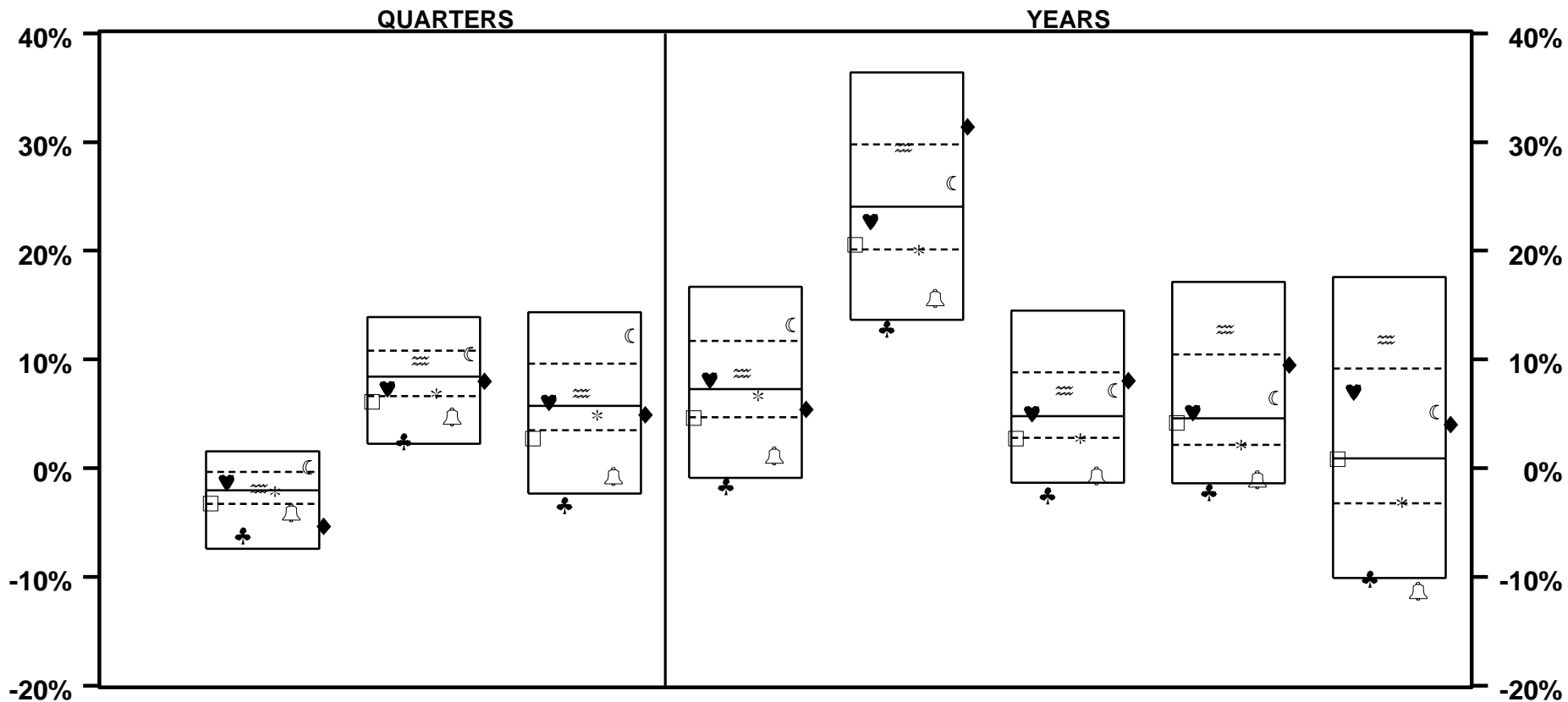

	LAST QTR		LAST 2 QTRS		LAST 3 QTRS		LAST YEAR		LAST 2 YEARS		LAST 3 YEARS		LAST 4 YEARS		LAST 5 YEARS	
□ EQTY COMPOSITE	-3.3	74	6.1	79	2.7	78	4.6	75	20.5	68	2.8	76	4.2	52	0.9	50
♥ DELAWARE	-1.3	36	7.3	61	6.1	47	8.1	43	22.7	56	5.0	48	5.1	47	7.0	31
♣ ALLIANCE	-6.2	92	2.5	94	-3.4	96	-1.7	96	12.8	96	-2.5	99	-2.2	96	-10.1	95
≡ LAZARD	-1.8	46	9.9	33	6.9	41	8.7	39	29.5	26	7.2	33	12.8	15	11.9	19
* S&P 500	-2.1	57	6.9	71	4.9	63	6.7	61	20.1	77	2.8	76	2.1	76	-3.2	73
🔔 R 1000(R) GR	-4.1	81	4.7	86	-0.8	91	1.2	88	15.6	91	-0.7	92	-1.0	93	-11.3	97
☾ R 1000(R) VALUE	0.1	19	10.5	27	12.2	14	13.2	18	26.2	39	7.2	34	6.5	39	5.2	37
◆ R 2000(R)	-5.3	89	8.0	53	4.9	62	5.4	71	31.4	16	8.0	29	9.5	27	4.0	41
MEDIAN	-2.0		8.4		5.7		7.3		24.1		4.8		4.6		0.9	

VERMONT MUNICIPAL EMPLOYEES

EQUITY FUNDS - TOTAL RATES OF RETURN

PERIODS ENDING 3/05

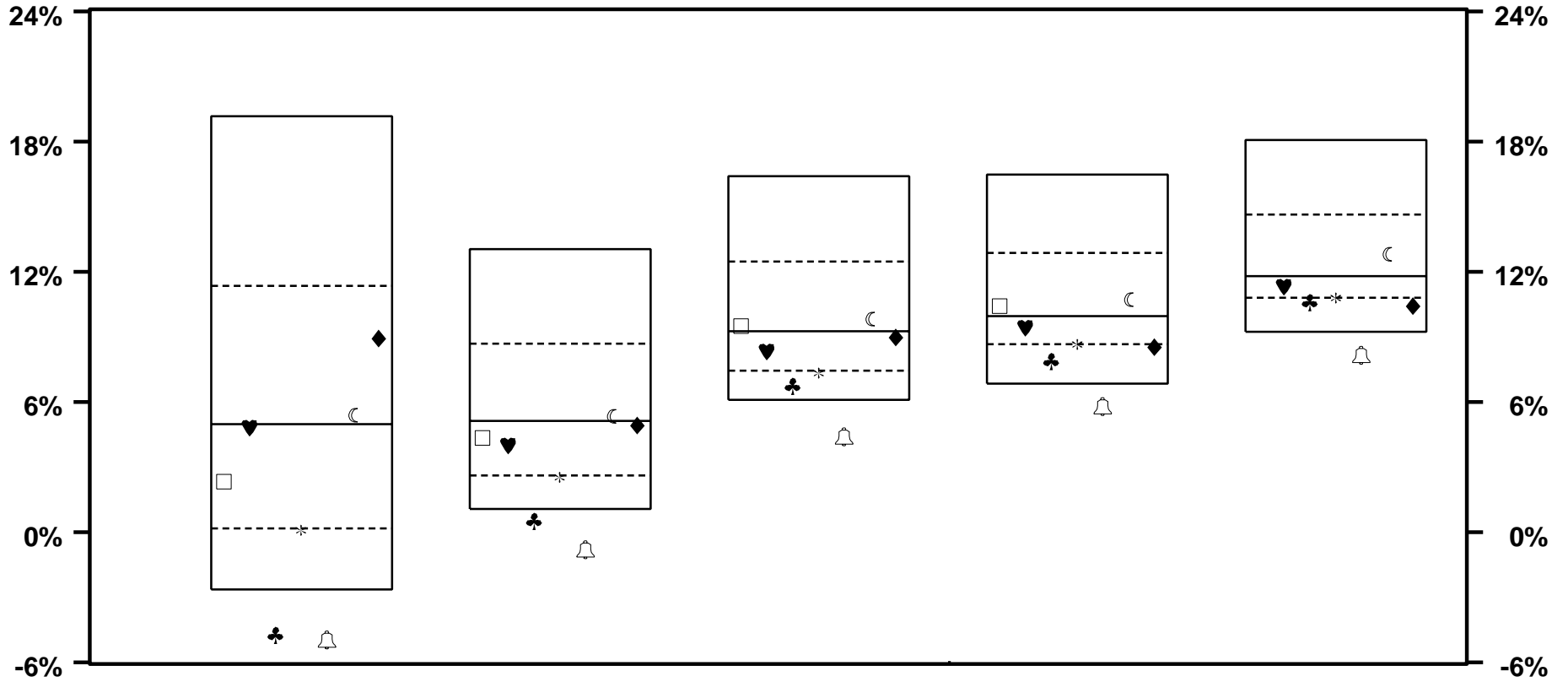

	LAST 6 YEARS		LAST 7 YEARS		LAST 8 YEARS		LAST 9 YEARS		LAST 10 YEARS	
□ EQTY COMPOSITE	2.3	62	4.3	58	9.5	46	10.4	44		
♥ DELAWARE	4.8	50	4.0	60	8.3	61	9.4	58	11.3	55
♣ ALLIANCE	-4.7	98	0.5	97	6.7	89	7.9	88	10.6	82
* S&P 500	0.1	81	2.5	81	7.3	80	8.7	76	10.8	74
🔔 R 1000(R) GR	-5.0	98	-0.8	99	4.4	99	5.8	97	8.1	99
☾ R 1000(R) VALUE	5.4	47	5.3	47	9.8	40	10.7	41	12.8	37
◆ R 2000(R)	8.9	32	4.9	50	9.0	52	8.5	81	10.4	83
MEDIAN	5.0		5.1		9.3		10.0		11.8	

VERMONT MUNICIPAL EMPLOYEES

EQUITY FUNDS - TOTAL RATES OF RETURN

YEARS ENDING

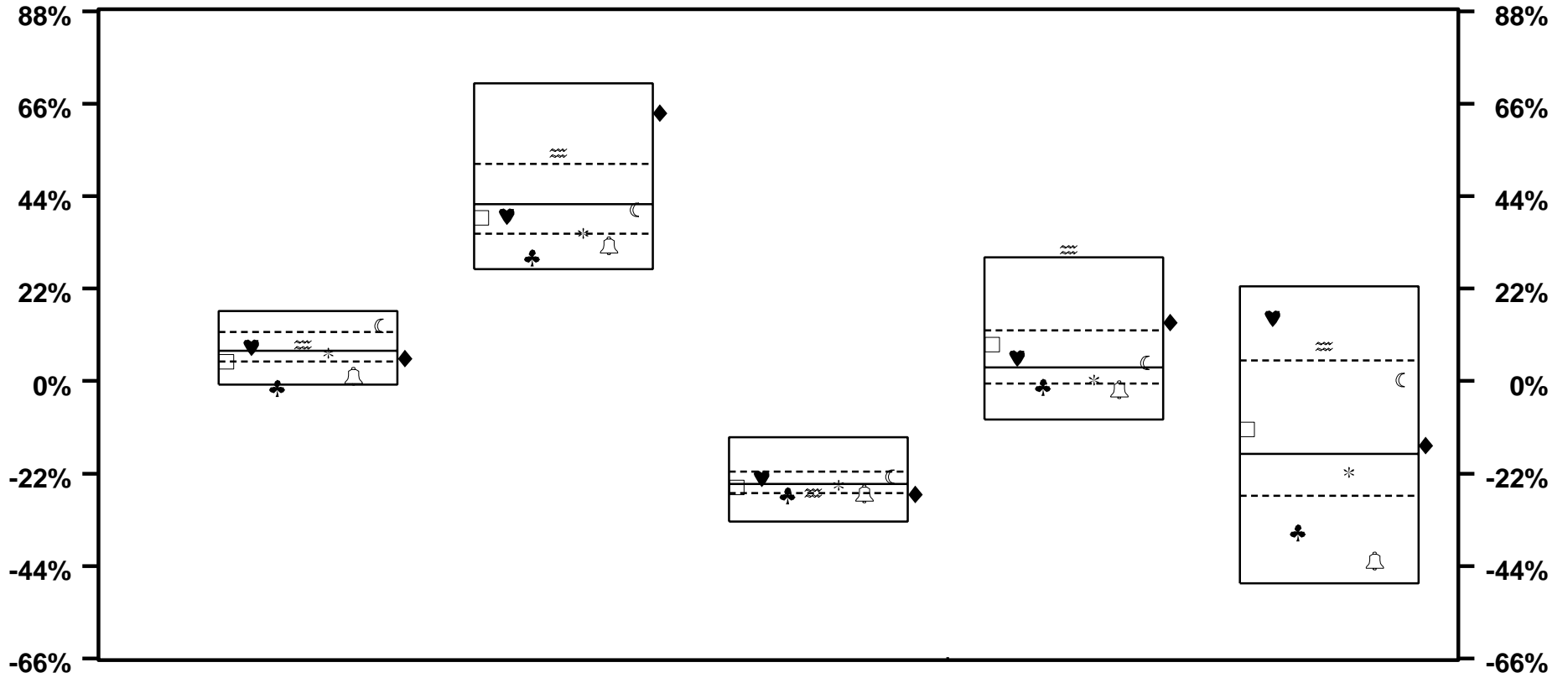

	3 / 05		3 / 04		3 / 03		3 / 02		3 / 01	
□ EQTY COMPOSITE	4.6	75	38.9	57	-25.3	65	8.7	32	-11.5	43
♥ DELAWARE	8.1	43	39.3	56	-23.1	37	5.5	39	14.9	13
♣ ALLIANCE	-1.7	96	29.4	90	-27.1	77	-1.3	77	-36.0	83
≡ LAZARD	8.7	39	54.3	20	-26.6	74	31.3	3	8.3	20
* S&P 500	6.7	61	35.1	74	-24.8	59	0.3	66	-21.7	64
🔔 R 1000(R) GR	1.2	88	32.2	84	-26.8	75	-2.0	79	-42.7	91
☾ R 1000(R) VALUE	13.2	18	40.8	52	-22.8	34	4.4	44	0.3	30
◆ R 2000(R)	5.4	71	63.8	8	-27.0	76	14.0	22	-15.3	47
MEDIAN	7.3		42.1		-24.4		3.2		-17.4	

VERMONT MUNICIPAL EMPLOYEES

EQUITY FUNDS - TOTAL RATES OF RETURN

YEARS ENDING

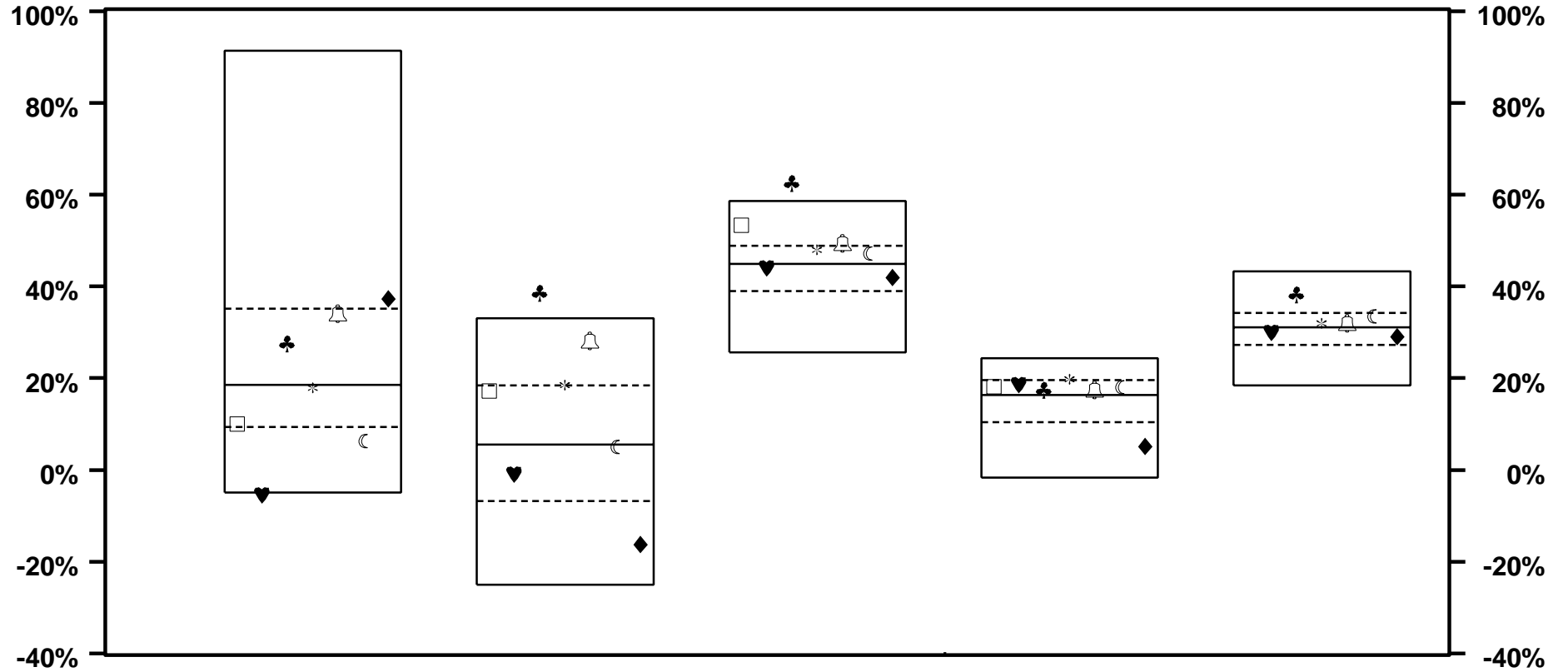

	3 / 00		3 / 99		3 / 98		3 / 97		3 / 96	
□ EQTY COMPOSITE	10.1	73	17.3	28	53.3	11	18.1	35		
♥ DELAWARE	- 5.4	95	- 0.9	65	44.1	53	18.7	31	30.0	57
♣ ALLIANCE	27.5	35	38.6	3	62.5	2	17.5	39	38.3	10
* S&P 500	18.0	55	18.5	24	48.0	32	19.8	21	32.0	41
🔔 R 1000(R) GR	34.1	26	28.1	8	49.5	22	17.5	39	32.0	42
☾ R 1000(R) VALUE	6.3	79	5.0	51	47.2	38	18.1	36	33.5	29
◆ R 2000(R)	37.3	23	- 16.3	85	42.0	63	5.1	87	29.0	63
MEDIAN	18.5		5.6		44.9		16.3		31.1	

VERMONT MUNICIPAL EMPLOYEES

EQUITY FUNDS - TOTAL VS EQUITY ONLY RETURNS

MARKET CYCLE PERFORMANCE COMPARISONS

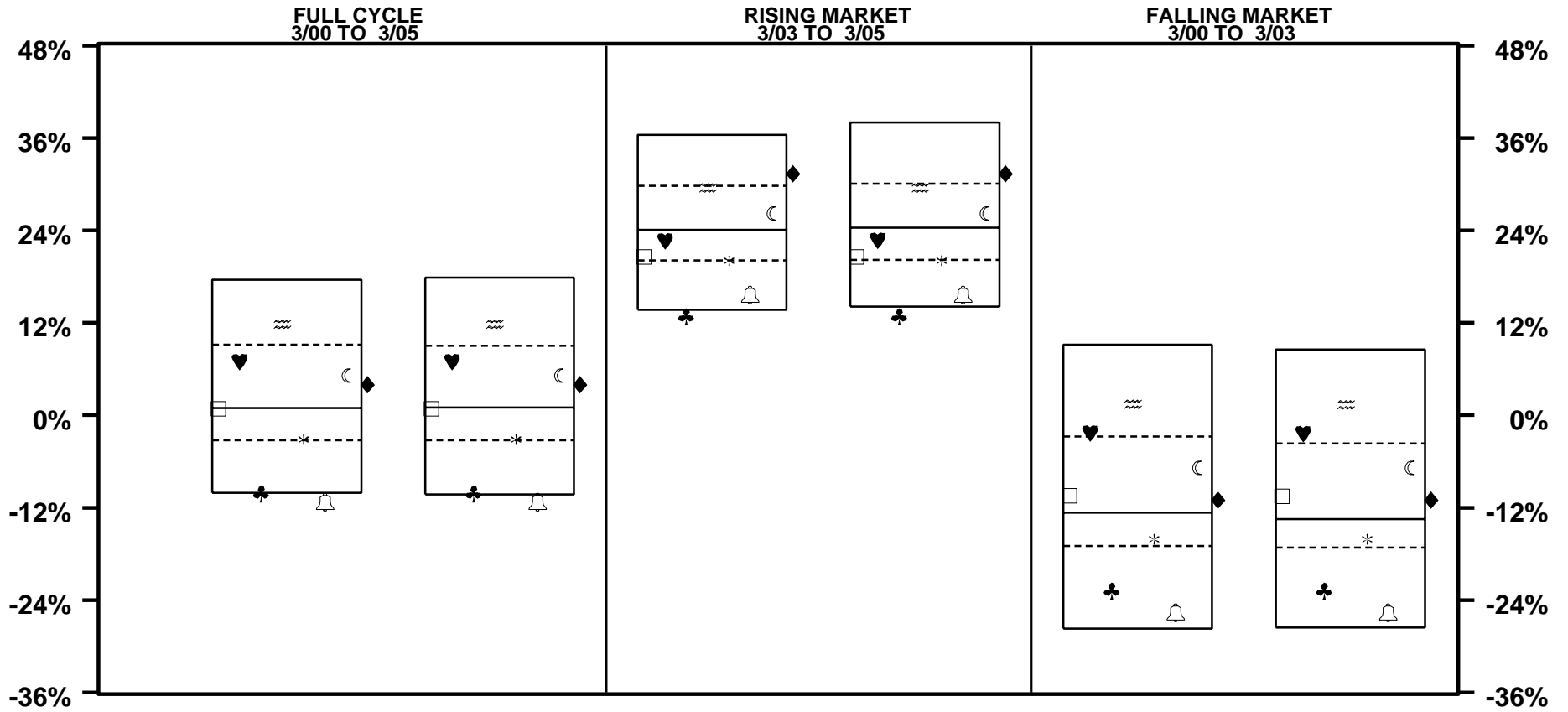

	TOTAL FUND		EQUITY ONLY		TOTAL FUND		EQUITY ONLY		TOTAL FUND		EQUITY ONLY	
□ EQTY COMPOSITE	0.9	50	0.8	50	20.5	68	20.5	70	-10.5	44	-10.5	42
♥ DELAWARE	7.0	31	7.0	30	22.7	56	22.7	57	-2.3	23	-2.3	22
♣ ALLIANCE	-10.1	95	-10.1	94	12.8	96	12.8	96	-22.8	87	-22.8	87
≡ LAZARD	11.9	19	11.8	20	29.5	26	29.5	28	1.4	16	1.4	15
* S&P 500	-3.2	73	-3.2	73	20.1	77	20.1	79	-16.1	68	-16.1	68
🔔 R 1000(R) GR	-11.3	97	-11.3	96	15.6	91	15.6	92	-25.6	92	-25.6	92
☾ R 1000(R) VALUE	5.2	37	5.2	36	26.2	39	26.2	41	-6.9	34	-6.9	32
◆ R 2000(R)	4.0	41	4.0	39	31.4	16	31.4	19	-11.0	46	-11.0	43
MEDIAN	0.9		1.0		24.1		24.4		-12.7		-13.5	

VERMONT MUNICIPAL EMPLOYEES

EQUITY FUNDS - TOTAL FUND INCOME RATES OF RETURN FOR PERIOD ENDING 3/05

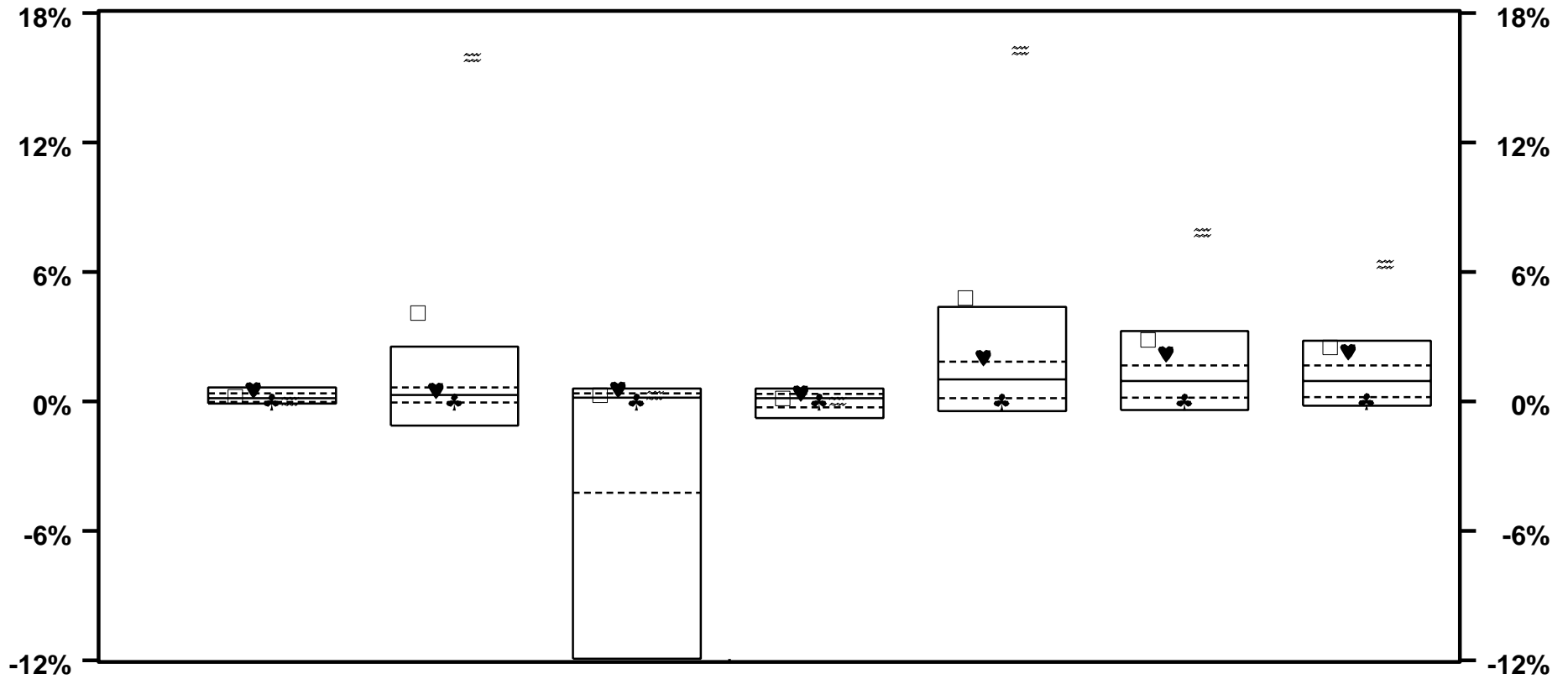

	THIS QUARTER		LAST QUARTER		2 QTRS AGO		3 QTRS AGO		LAST YEAR		LAST 2 YEARS		LAST 3 YEARS	
□ EQTY COMPOSITE	0.2	42	4.1	2	0.3	33	0.2	49	4.8	4	2.8	6	2.5	7
♥ DELAWARE	0.5	9	0.5	34	0.6	6	0.4	20	2.0	19	2.2	12	2.3	9
♣ ALLIANCE	0.0	64	0.0	74	0.0	63	0.0	64	0.0	78	0.0	79	0.0	81
≡ LAZARD	0.0	64	15.9	1	0.3	34	0.0	63	16.3	1	7.8	1	6.4	1
MEDIAN	0.1		0.3		0.2		0.1		1.0		0.9		1.0	

VERMONT MUNICIPAL EMPLOYEES

EQUITY FUNDS - TOTAL RETURN VS RISK

3 YEARS ENDING 3/05

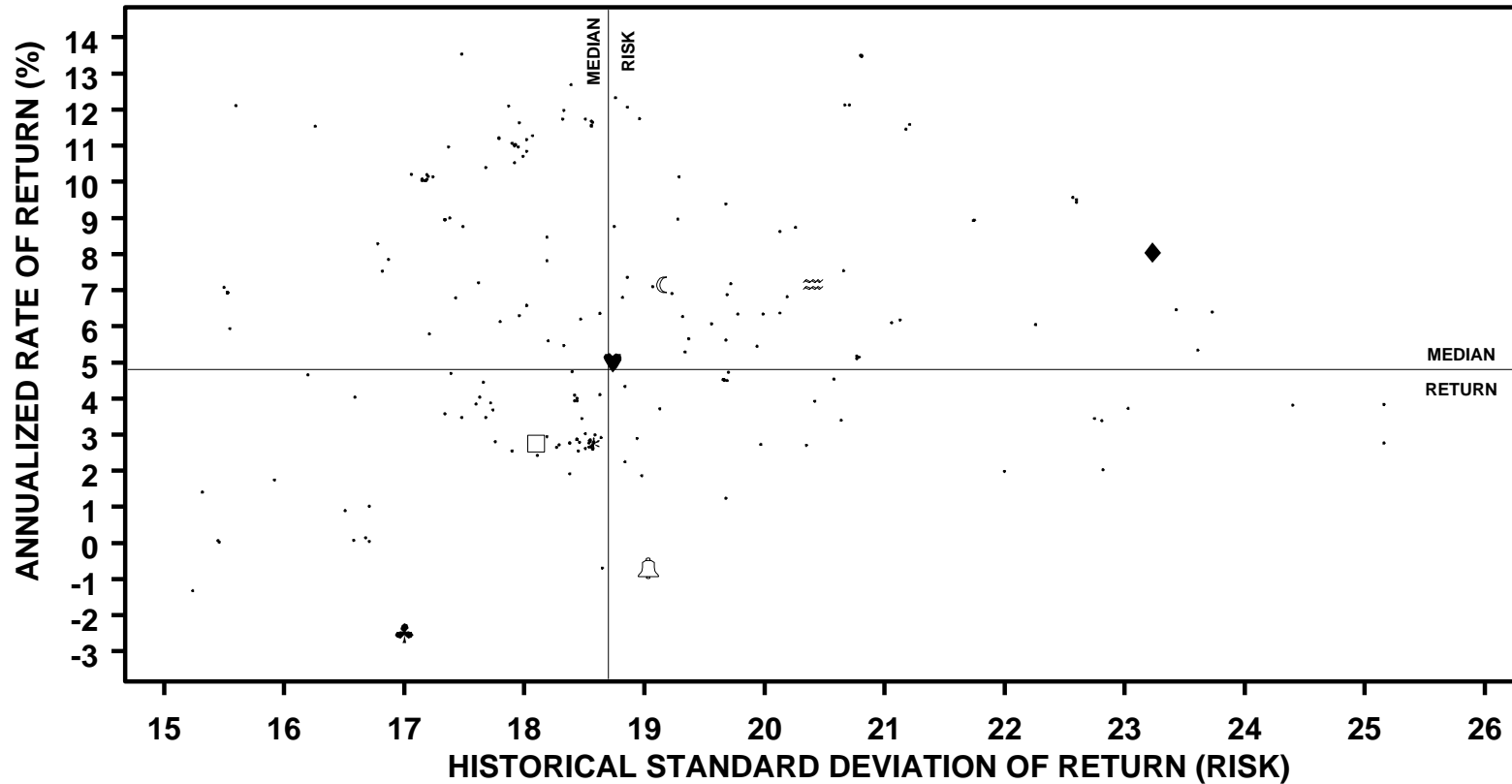

	ANNUALIZED RETURN		STANDARD DEVIATION		SHARPE RATIO	
	VALUE	RANK	VALUE	RANK	VALUE	RANK
□ EQTY COMPOSITE	2.8	76	18.1	69	0.2	73
♥ DELAWARE	5.0	48	18.7	48	0.3	48
♣ ALLIANCE	-2.5	99	17.0	84	-0.1	
≍ LAZARD	7.2	33	20.4	29	0.4	36
* S&P 500	2.8	76	18.6	52	0.2	73
🔔 R 1000(R) GR	-0.7	92	19.0	44	0.0	
☾ R 1000(R) VALUE	7.2	34	19.1	42	0.4	34
◆ R 2000(R)	8.0	29	23.2	13	0.4	33
MEDIAN	4.8		18.7		0.3	

VERMONT MUNICIPAL EMPLOYEES

EQUITY FUNDS - TOTAL RETURN VS RISK

5 YEARS ENDING 3/05

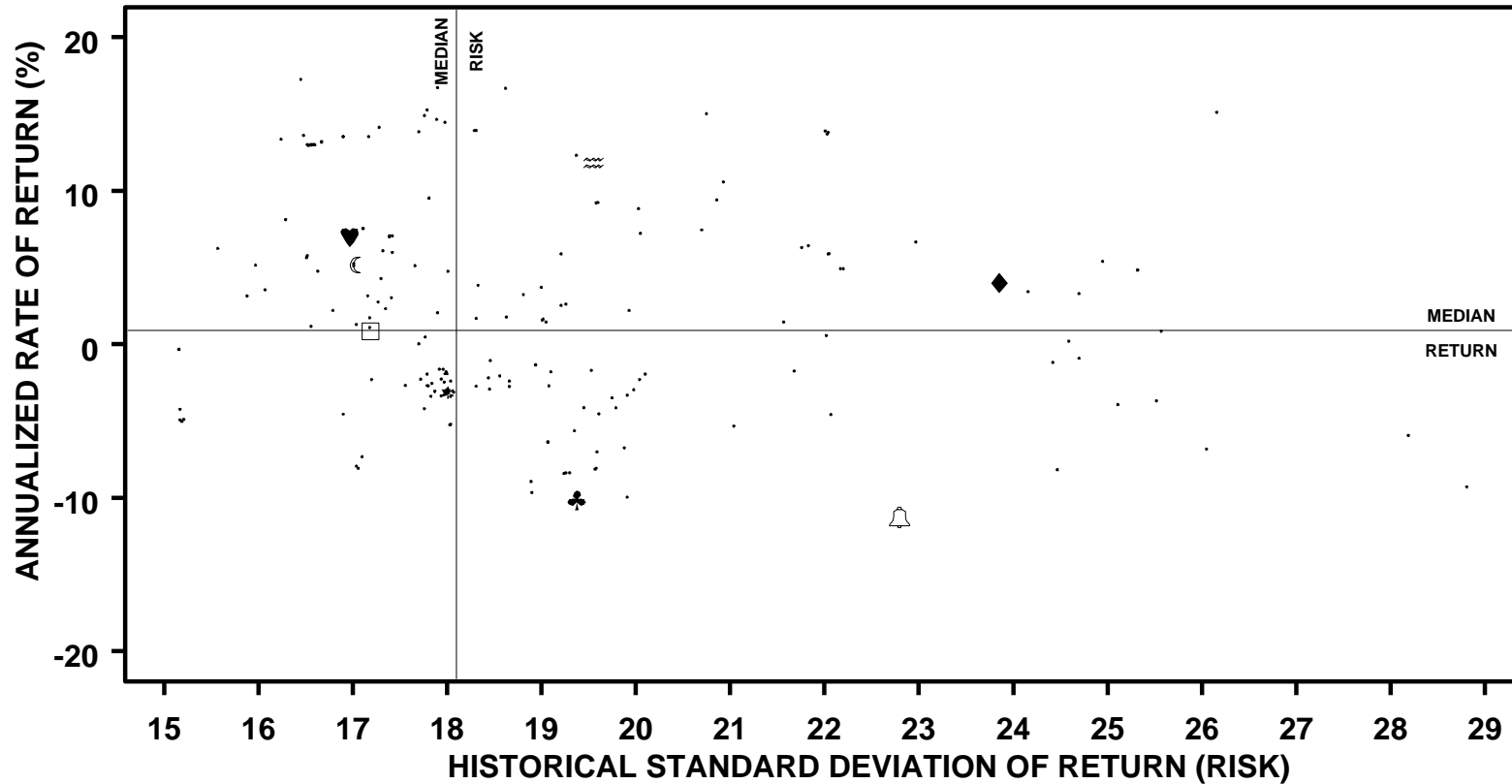

	ANNUALIZED RETURN		STANDARD DEVIATION		SHARPE RATIO	
	VALUE	RANK	VALUE	RANK	VALUE	RANK
□ EQTY COMPOSITE	0.9	50	17.2	73	0.0	
♥ DELAWARE	7.0	31	17.0	76	0.3	30
♣ ALLIANCE	-10.1	95	19.4	38	-0.6	
≈ LAZARD	11.9	19	19.6	36	0.5	20
* S&P 500	-3.2	73	18.0	53	-0.2	
🔔 R 1000(R) GR	-11.3	97	22.8	18	-0.5	
☾ R 1000(R) VALUE	5.2	37	17.0	75	0.2	37
◆ R 2000(R)	4.0	41	23.9	16	0.2	41
MEDIAN	0.9		18.1		0.0	

VERMONT MUNICIPAL EMPLOYEES

EQUITY ONLY - RATES OF RETURN

PERIODS ENDING 3/05

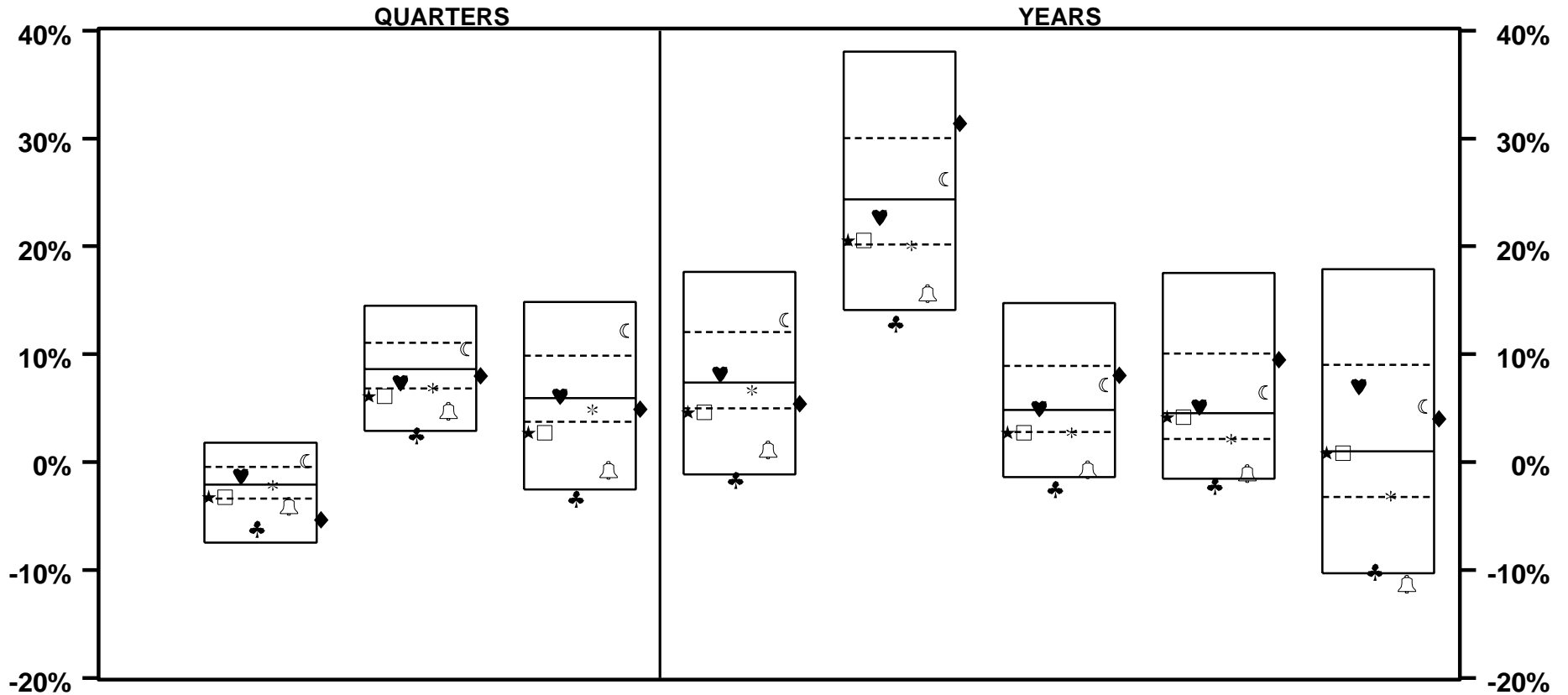

	LAST QTR		LAST 2 QTRS		LAST 3 QTRS		LAST YEAR		LAST 2 YEARS		LAST 3 YEARS		LAST 4 YEARS		LAST 5 YEARS	
★ MUNI COMPOSITE	- 3.3	74	6.1	81	2.7	80	4.6	76	20.5	70	2.7	77	4.2	51	0.8	50
□ EQTY COMPOSITE	- 3.3	74	6.1	81	2.7	80	4.6	76	20.5	70	2.7	77	4.2	51	0.8	50
♥ DELAWARE	- 1.3	34	7.4	63	6.1	48	8.2	44	22.7	57	5.0	49	5.1	46	7.0	30
♣ ALLIANCE	- 6.2	91	2.5	96	- 3.4	96	- 1.7	95	12.8	96	- 2.5	98	- 2.2	96	- 10.1	94
* S&P 500	- 2.1	55	6.9	73	4.9	64	6.7	63	20.1	79	2.8	76	2.1	75	- 3.2	73
🔔 R 1000(R) GR	- 4.1	80	4.7	88	- 0.8	91	1.2	89	15.6	92	- 0.7	92	- 1.0	93	- 11.3	96
☾ R 1000(R) VALUE	0.1	19	10.5	29	12.2	15	13.2	19	26.2	41	7.2	34	6.5	38	5.2	36
◆ R 2000(R)	- 5.3	88	8.0	55	4.9	63	5.4	73	31.4	19	8.0	29	9.5	26	4.0	39
MEDIAN	- 2.1		8.6		5.9		7.4		24.4		4.8		4.5		1.0	

VERMONT MUNICIPAL EMPLOYEES

EQUITY ONLY - RATES OF RETURN

PERIODS ENDING 3/05

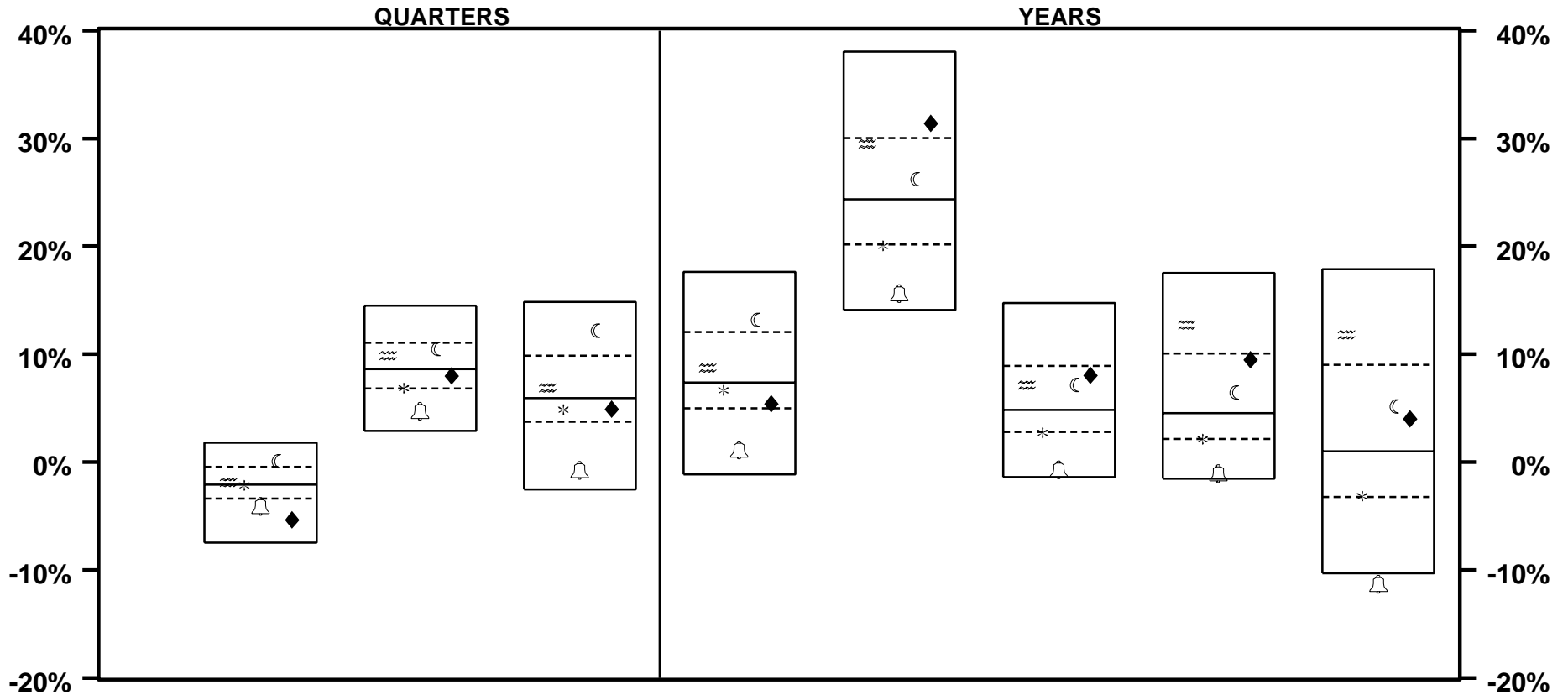

	LAST QTR		LAST 2 QTRS		LAST 3 QTRS		LAST YEAR		LAST 2 YEARS		LAST 3 YEARS		LAST 4 YEARS		LAST 5 YEARS	
≈ LAZARD	- 1.8	45	9.9	35	6.9	43	8.7	41	29.5	28	7.2	34	12.7	15	11.8	20
* S&P 500	- 2.1	55	6.9	73	4.9	64	6.7	63	20.1	79	2.8	76	2.1	75	- 3.2	73
🔔 R 1000(R) GR	- 4.1	80	4.7	88	- 0.8	91	1.2	89	15.6	92	- 0.7	92	- 1.0	93	- 11.3	96
☾ R 1000(R) VALUE	0.1	19	10.5	29	12.2	15	13.2	19	26.2	41	7.2	34	6.5	38	5.2	36
◆ R 2000(R)	- 5.3	88	8.0	55	4.9	63	5.4	73	31.4	19	8.0	29	9.5	26	4.0	39
MEDIAN	- 2.1		8.6		5.9		7.4		24.4		4.8		4.5		1.0	

VERMONT MUNICIPAL EMPLOYEES

EQUITY ONLY - RATES OF RETURN

PERIODS ENDING 3/05

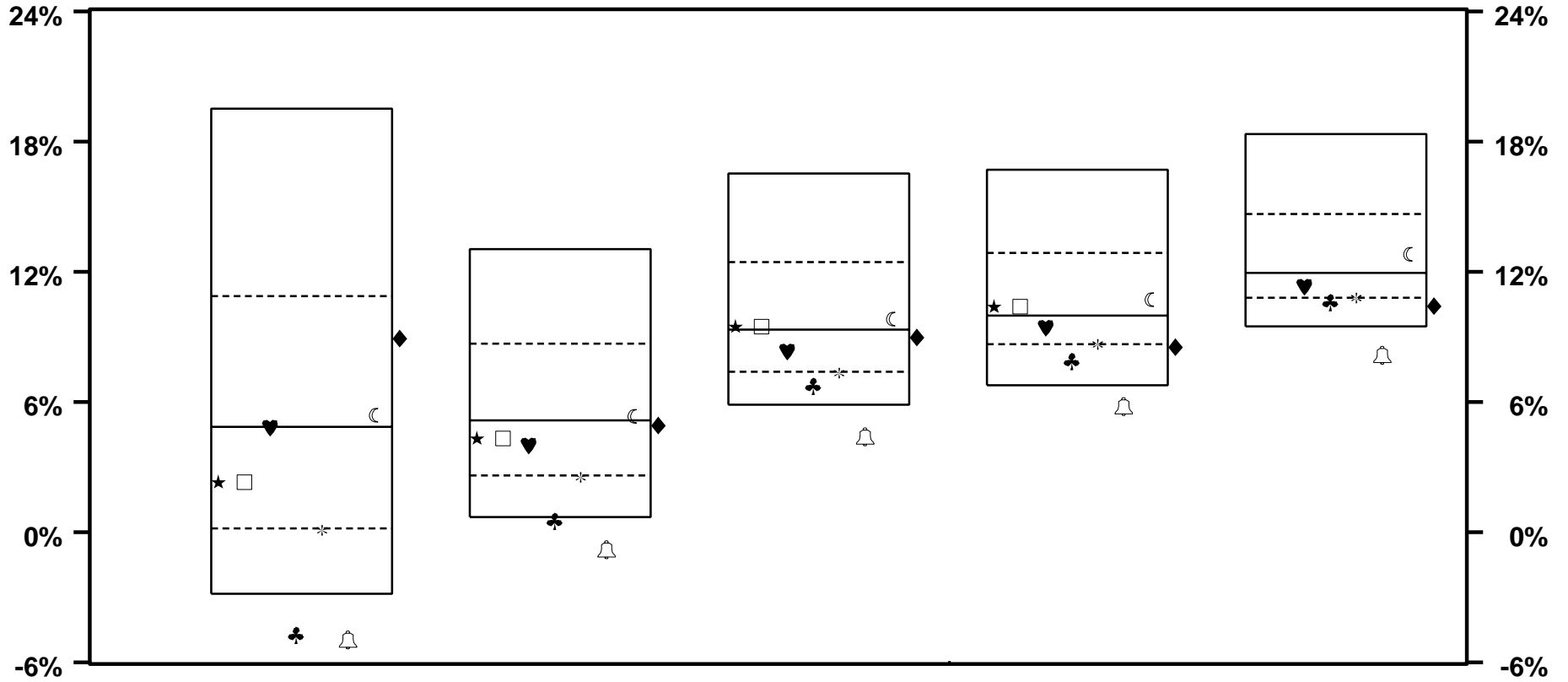

	LAST 6 YEARS		LAST 7 YEARS		LAST 8 YEARS		LAST 9 YEARS		LAST 10 YEARS	
★ MUNI COMPOSITE	2.3	62	4.3	56	9.5	48	10.4	44		
□ EQTY COMPOSITE	2.3	62	4.3	56	9.5	48	10.4	44		
♥ DELAWARE	4.8	50	4.0	59	8.3	61	9.4	58	11.3	59
♣ ALLIANCE	-4.7	98	0.5	95	6.7	89	7.9	87	10.6	82
* S&P 500	0.1	80	2.5	80	7.3	78	8.7	75	10.8	75
🔔 R 1000(R) GR	-5.0	99	-0.8	99	4.4	99	5.8	97	8.1	98
☾ R 1000(R) VALUE	5.4	46	5.3	48	9.8	42	10.7	41	12.8	39
◆ R 2000(R)	8.9	31	4.9	51	9.0	53	8.5	80	10.4	84
MEDIAN	4.8		5.1		9.3		10.0		11.9	

VERMONT MUNICIPAL EMPLOYEES

EQUITY ONLY - RATES OF RETURN

YEARS ENDING

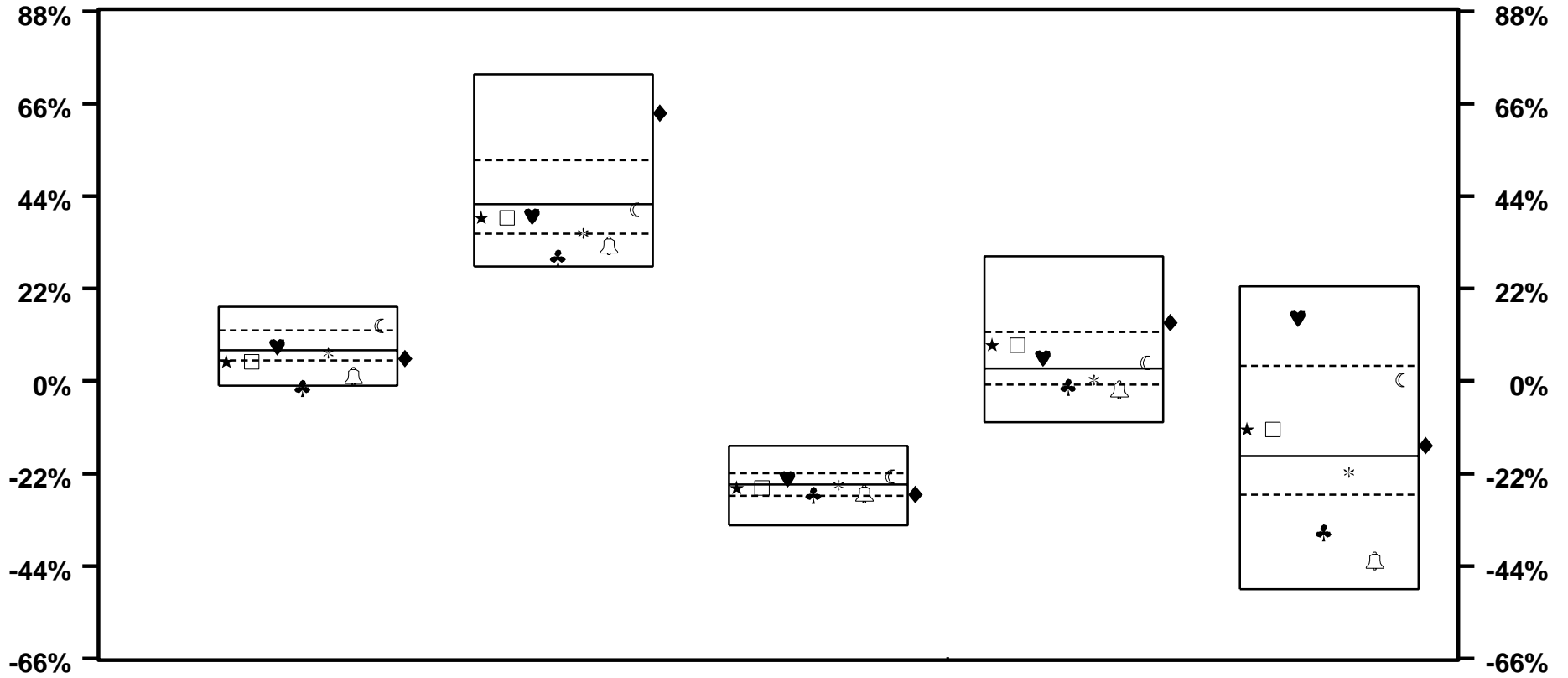

	3 / 05		3 / 04		3 / 03		3 / 02		3 / 01	
★ MUNI COMPOSITE	4.6	76	38.9	57	-25.4	62	8.6	31	-11.5	42
□ EQTY COMPOSITE	4.6	76	38.9	57	-25.4	62	8.6	31	-11.5	42
♥ DELAWARE	8.2	44	39.3	56	-23.2	33	5.5	38	14.9	13
♣ ALLIANCE	-1.7	95	29.4	91	-27.1	74	-1.4	76	-36.0	83
* S&P 500	6.7	63	35.1	74	-24.8	54	0.3	65	-21.7	63
🔔 R 1000(R) GR	1.2	89	32.2	85	-26.8	71	-2.0	79	-42.7	90
☾ R 1000(R) VALUE	13.2	19	40.8	52	-22.8	30	4.4	43	0.3	29
◆ R 2000(R)	5.4	73	63.8	9	-27.0	73	14.0	21	-15.3	46
MEDIAN	7.4		42.1		-24.7		2.9		-17.9	

VERMONT MUNICIPAL EMPLOYEES

EQUITY ONLY - RATES OF RETURN

YEARS ENDING

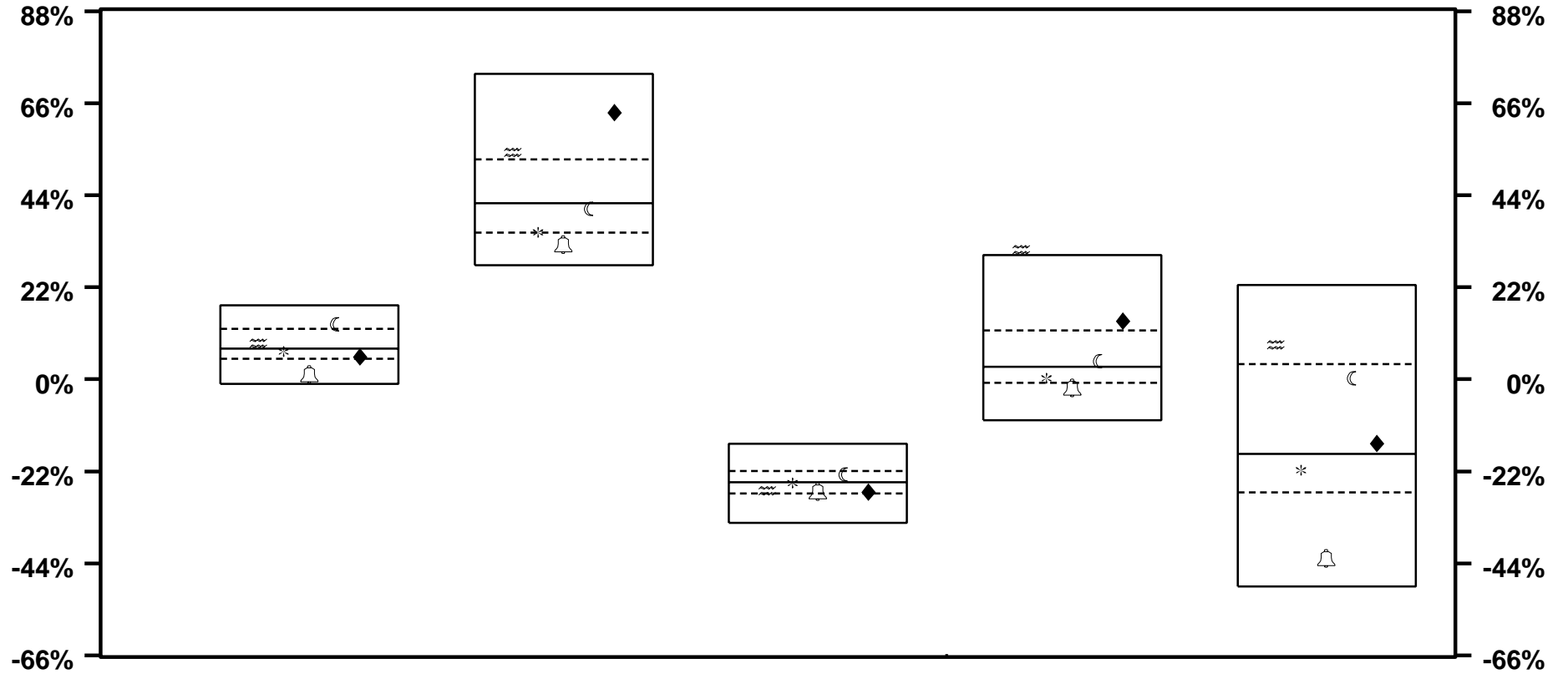

	3 / 05		3 / 04		3 / 03		3 / 02		3 / 01	
≈ LAZARD	8.7	41	54.3	21	-26.6	70	31.1	4	8.3	19
* S&P 500	6.7	63	35.1	74	-24.8	54	0.3	65	-21.7	63
🔔 R 1000(R) GR	1.2	89	32.2	85	-26.8	71	-2.0	79	-42.7	90
Ⓒ R 1000(R) VALUE	13.2	19	40.8	52	-22.8	30	4.4	43	0.3	29
◆ R 2000(R)	5.4	73	63.8	9	-27.0	73	14.0	21	-15.3	46
MEDIAN	7.4		42.1		-24.7		2.9		-17.9	

VERMONT MUNICIPAL EMPLOYEES

EQUITY ONLY - RATES OF RETURN

YEARS ENDING

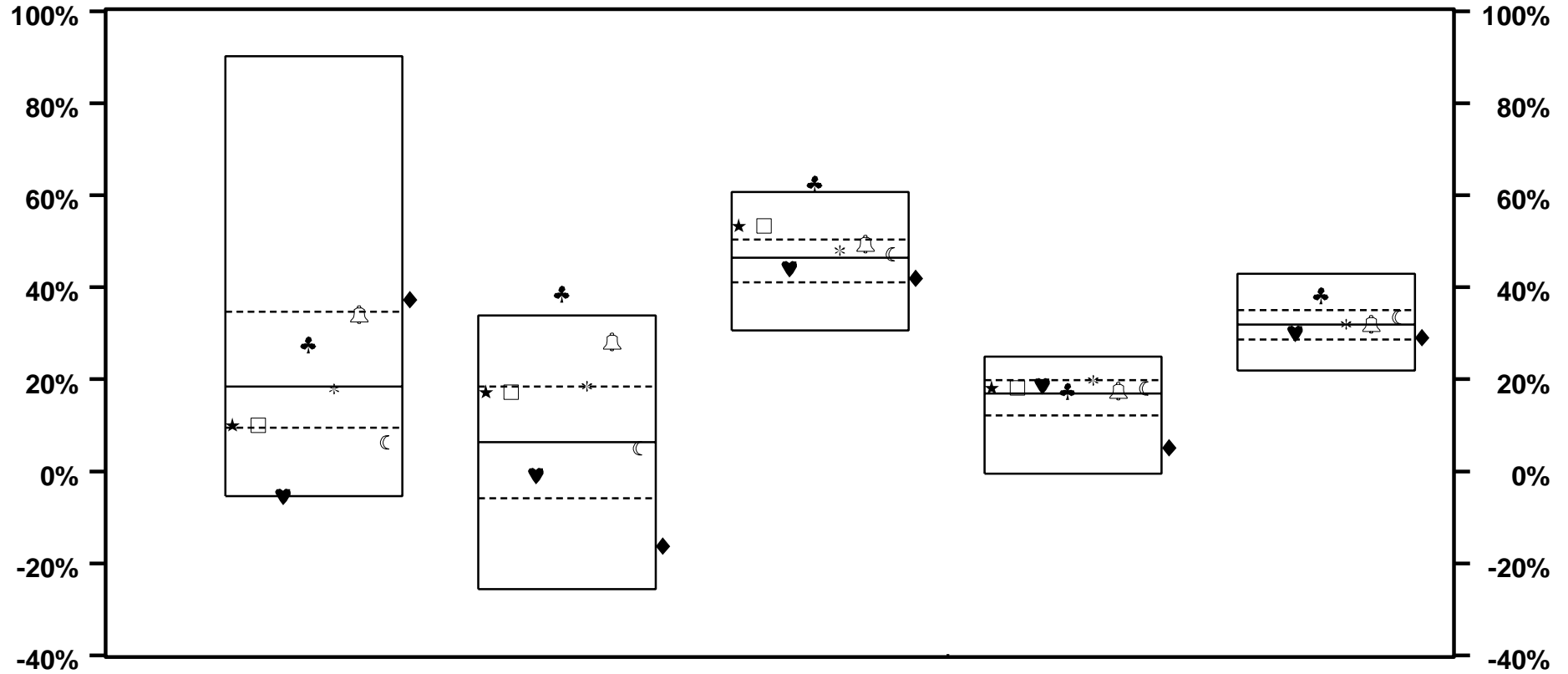

	3 / 00		3 / 99		3 / 98		3 / 97		3 / 96	
★ MUNI COMPOSITE	10.1	73	17.3	30	53.3	15	18.1	40		
□ EQTY COMPOSITE	10.1	73	17.3	30	53.3	15	18.1	40		
♥ DELAWARE	- 5.4	95	- 0.9	67	44.1	61	18.7	35	30.0	64
♣ ALLIANCE	27.5	35	38.6	3	62.5	3	17.5	45	38.3	12
* S&P 500	18.0	54	18.5	25	48.0	38	19.8	24	32.0	47
🔔 R 1000(R) GR	34.1	25	28.1	8	49.5	28	17.5	45	32.0	48
☾ R 1000(R) VALUE	6.3	79	5.0	52	47.2	45	18.1	40	33.5	33
◆ R 2000(R)	37.3	22	- 16.3	86	42.0	70	5.1	89	29.0	71
MEDIAN	18.4		6.3		46.4		16.9		31.8	

VERMONT MUNICIPAL EMPLOYEES

EQUITY ONLY - ACTIVELY MANAGED - PURCHASES & SALES TURNOVER

PERIODS ENDING 3/05

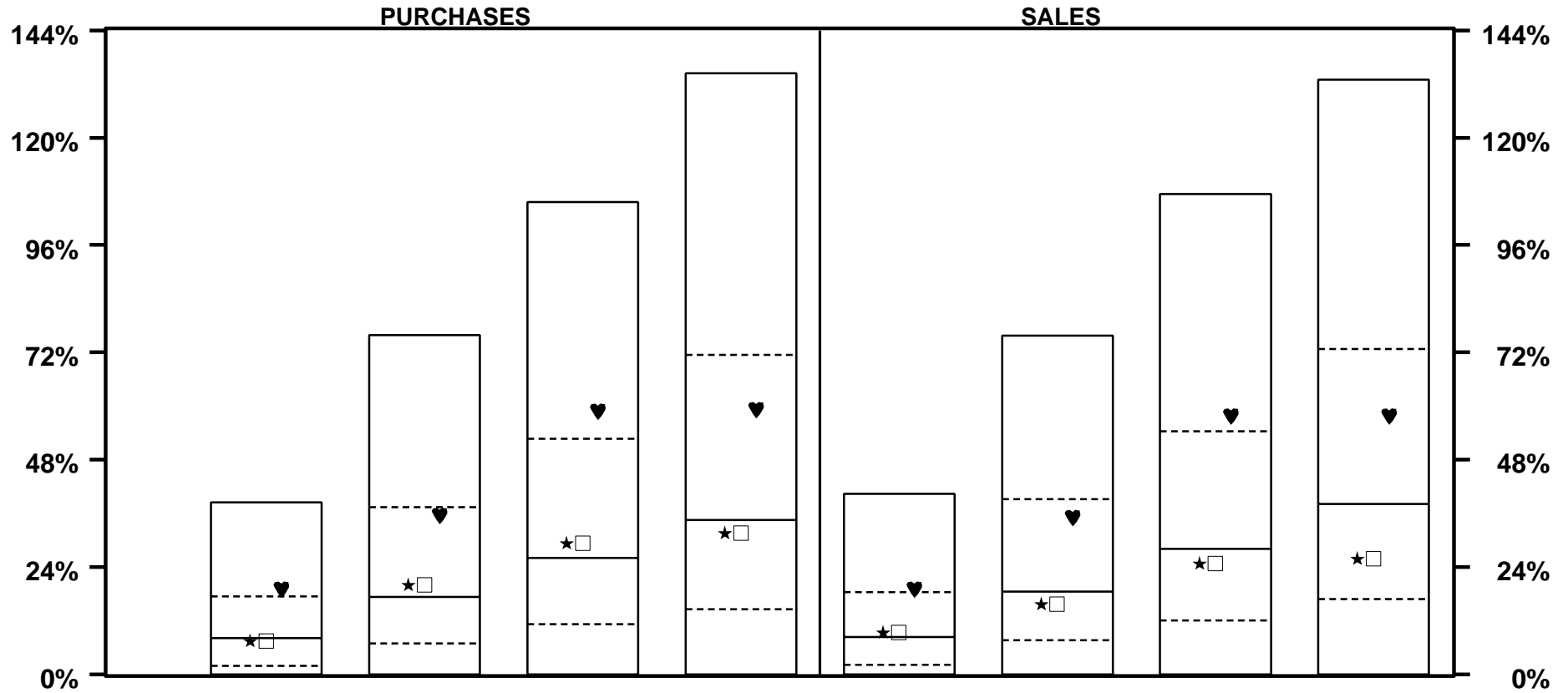

	LAST QTR		LAST 2 QTRS		LAST 3 QTRS		LAST YEAR		LAST QTR		LAST 2 QTRS		LAST 3 QTRS		LAST YEAR	
★ MUNI COMPOSITE	7.5	52	20.0	45	29.4	46	31.6	52	9.4	47	15.7	55	24.9	53	25.9	63
□ EQTY COMPOSITE	7.5	52	20.0	45	29.4	46	31.6	52	9.4	47	15.7	55	24.9	53	25.9	63
♥ DELAWARE	19.1	21	35.6	26	58.9	21	59.3	30	19.1	23	35.1	28	57.8	22	57.8	33
MEDIAN	8.1		17.3		26.0		34.5		8.3		18.5		28.0		38.1	

VERMONT MUNICIPAL EMPLOYEES

EQUITY ONLY - BUY & HOLD VS ACTUAL RETURNS

PERIODS ENDING 3/05

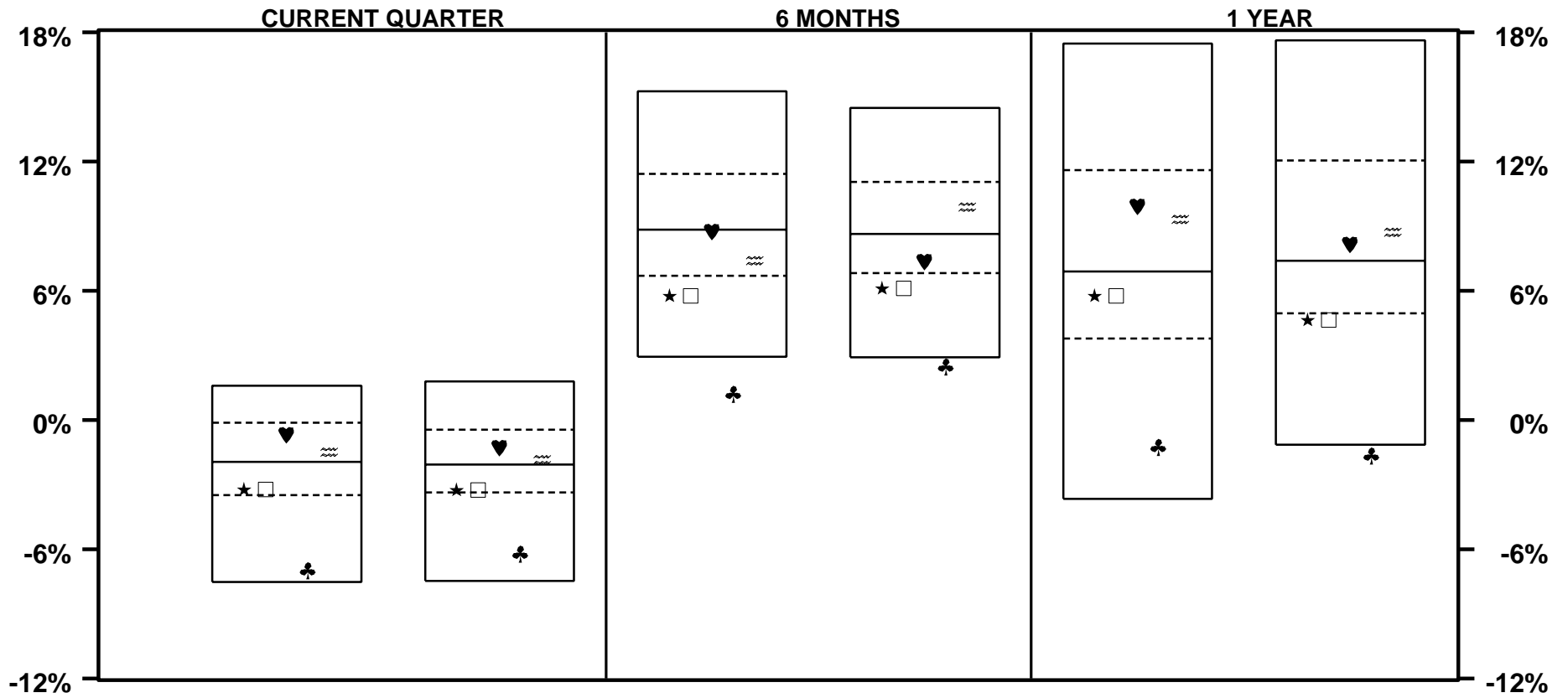

	BUY & HOLD		EQUITY ONLY		BUY & HOLD		EQUITY ONLY		BUY & HOLD		EQUITY ONLY	
★ MUNI COMPOSITE	-3.2	72	-3.3	74	5.8	83	6.1	81	5.8	64	4.6	76
□ EQTY COMPOSITE	-3.2	72	-3.3	74	5.8	83	6.1	81	5.8	64	4.6	76
♥ DELAWARE	-0.7	30	-1.3	34	8.8	50	7.4	63	9.9	32	8.2	44
♣ ALLIANCE	-7.0	92	-6.2	91	1.2	97	2.5	96	-1.3	91	-1.7	95
≈ LAZARD	-1.5	42	-1.8	45	7.4	64	9.9	35	9.3	35	8.7	41
MEDIAN	-1.9		-2.1		8.8		8.6		6.9		7.4	

VERMONT MUNICIPAL EMPLOYEES

EQUITY ONLY RETURNS VS RISK

3 YEARS ENDING 3/05

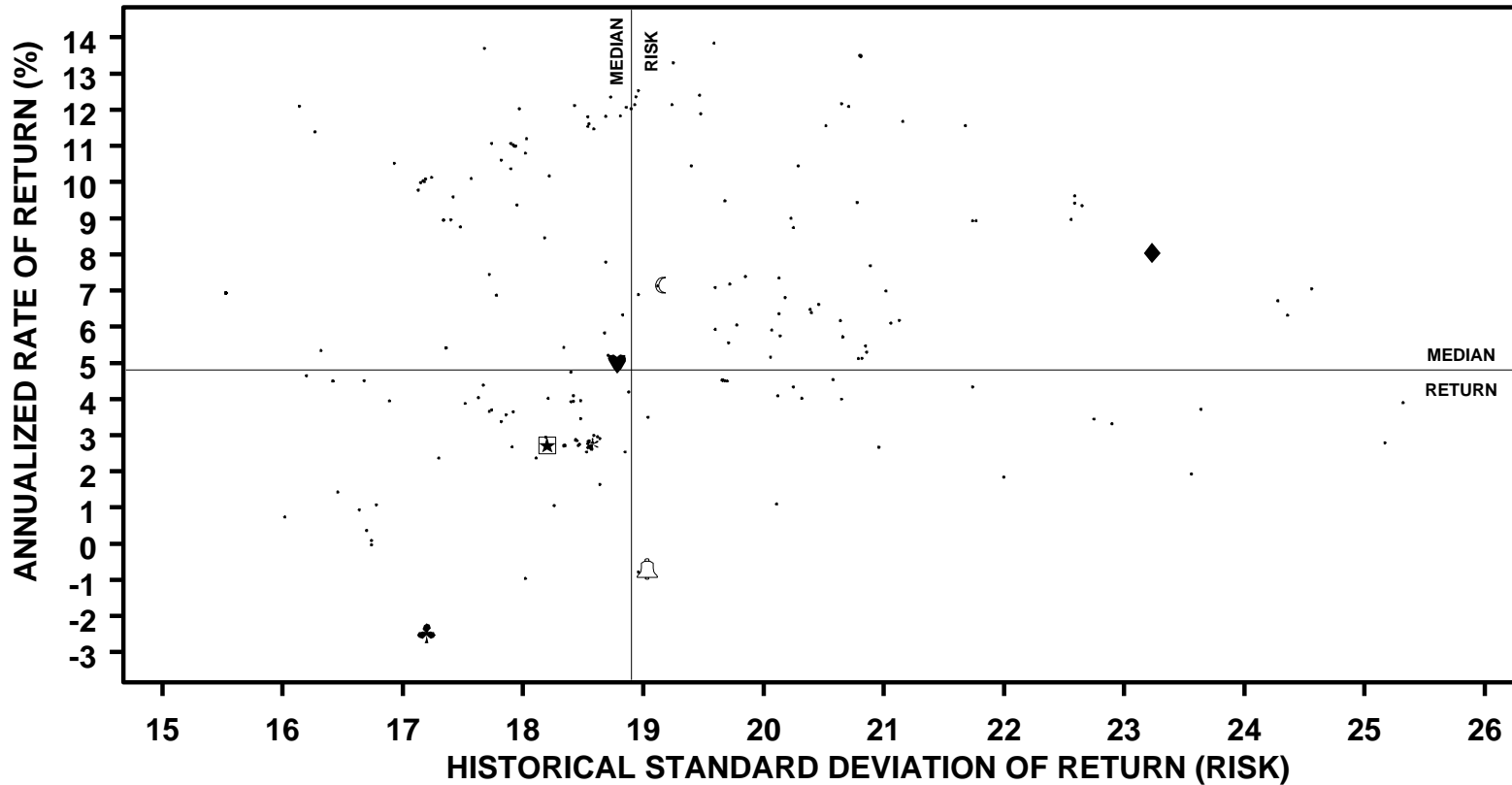

	ANNUALIZED RETURN		STANDARD DEVIATION		SHARPE RATIO	
	VALUE	RANK	VALUE	RANK	VALUE	RANK
★ MUNI COMPOSITE	2.7	77	18.2	70	0.2	74
□ EQTY COMPOSITE	2.7	77	18.2	70	0.2	74
♥ DELAWARE	5.0	49	18.8	51	0.3	48
♣ ALLIANCE	-2.5	98	17.2	85	-0.1	
* S&P 500	2.8	76	18.6	58	0.2	73
🔔 R 1000(R) GR	-0.7	92	19.0	47	0.0	
☾ R 1000(R) VALUE	7.2	34	19.1	46	0.4	33
◆ R 2000(R)	8.0	29	23.2	14	0.4	32
MEDIAN	4.8		18.9		0.3	

VERMONT MUNICIPAL EMPLOYEES

EQUITY ONLY RETURNS VS RISK

3 YEARS ENDING 3/05

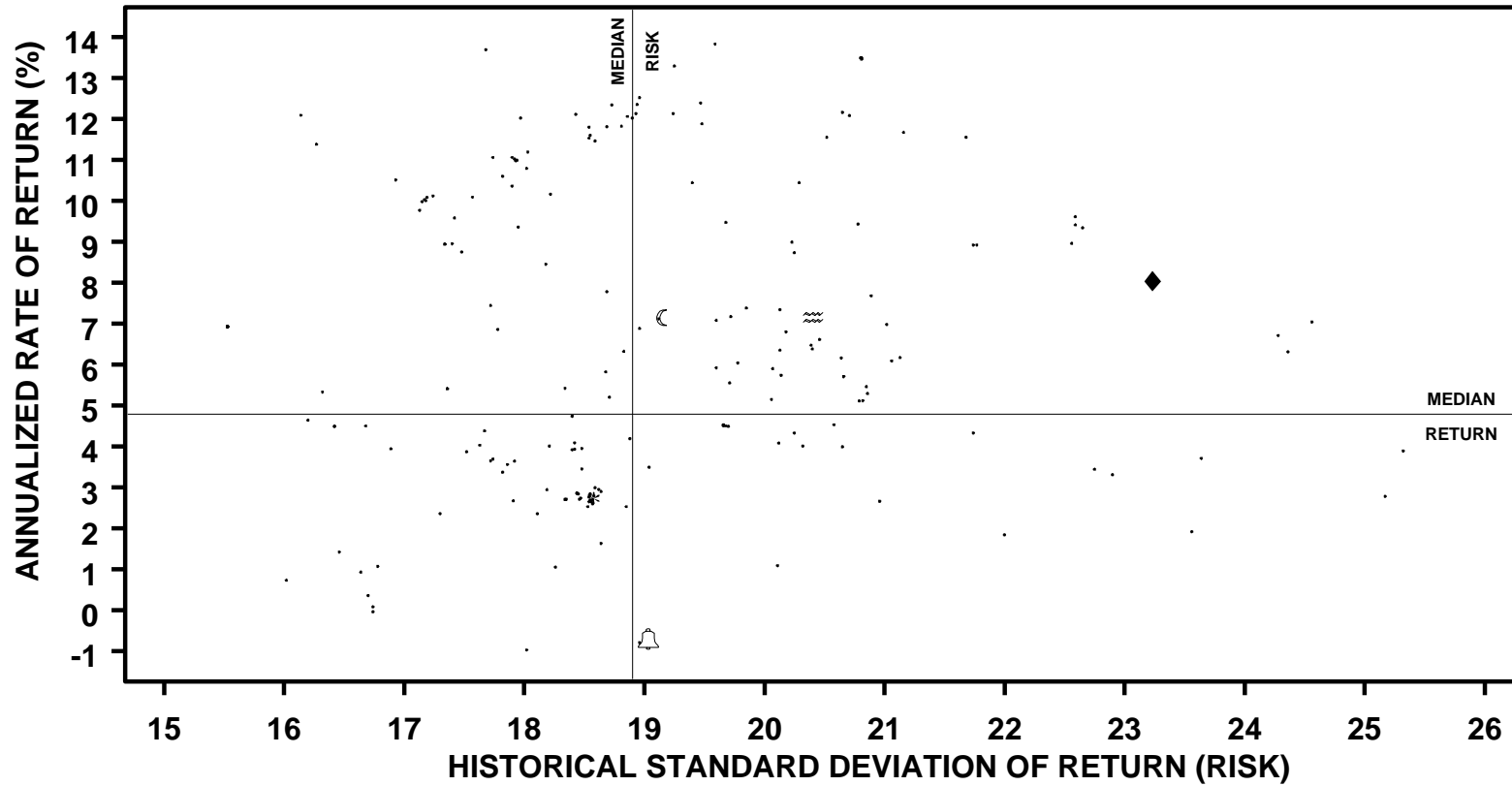

	ANNUALIZED RETURN		STANDARD DEVIATION		SHARPE RATIO	
	VALUE	RANK	VALUE	RANK	VALUE	RANK
≈ LAZARD	7.2	34	20.4	32	0.4	35
* S&P 500	2.8	76	18.6	58	0.2	73
🔔 R 1000(R) GR	-0.7	92	19.0	47	0.0	
☾ R 1000(R) VALUE	7.2	34	19.1	46	0.4	33
◆ R 2000(R)	8.0	29	23.2	14	0.4	32
MEDIAN	4.8		18.9		0.3	

VERMONT MUNICIPAL EMPLOYEES

EQUITY ONLY RETURNS VS RISK

5 YEARS ENDING 3/05

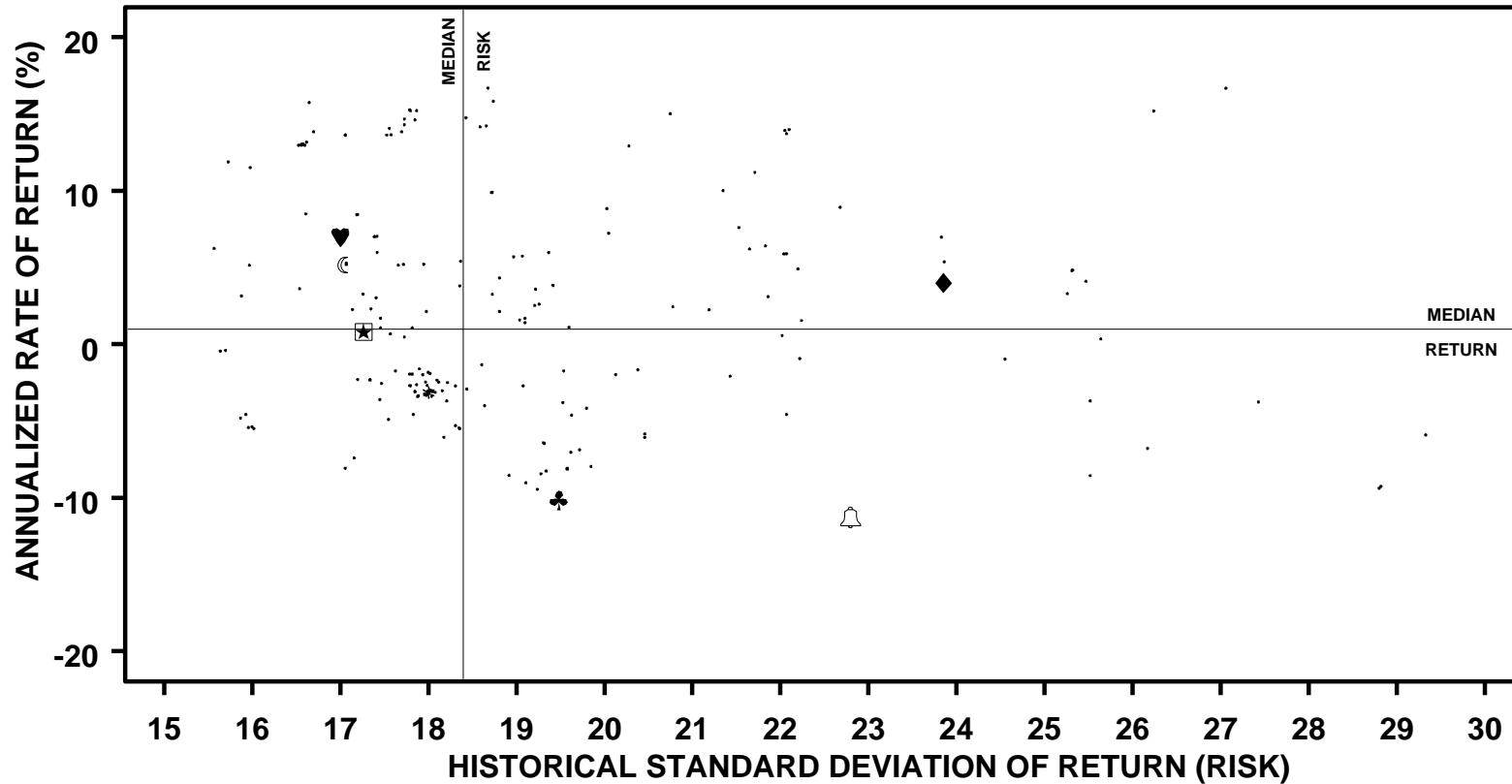

	ANNUALIZED RETURN		STANDARD DEVIATION		SHARPE RATIO	
	VALUE	RANK	VALUE	RANK	VALUE	RANK
★ MUNI COMPOSITE	0.8	50	17.3	77	0.0	
□ EQTY COMPOSITE	0.8	50	17.3	77	0.0	
♥ DELAWARE	7.0	30	17.0	80	0.3	29
♣ ALLIANCE	-10.1	94	19.5	39	-0.6	
* S&P 500	-3.2	73	18.0	58	-0.2	
🔔 R 1000(R) GR	-11.3	96	22.8	18	-0.5	
☾ R 1000(R) VALUE	5.2	36	17.0	80	0.2	36
◆ R 2000(R)	4.0	39	23.9	16	0.2	40
MEDIAN	1.0		18.4		0.0	

VERMONT MUNICIPAL EMPLOYEES

EQUITY ONLY RETURNS VS RISK

5 YEARS ENDING 3/05

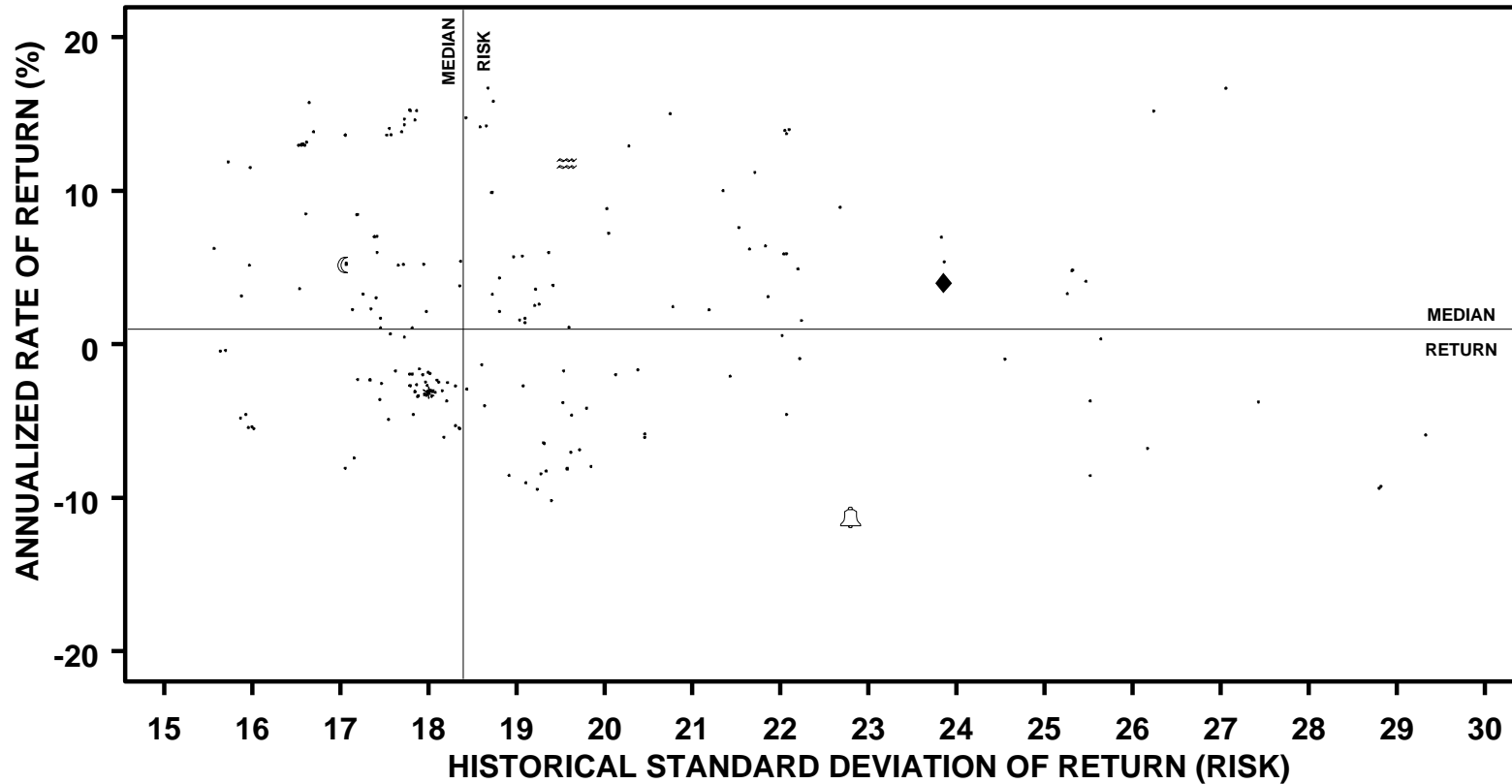

	ANNUALIZED RETURN		STANDARD DEVIATION		SHARPE RATIO	
	VALUE	RANK	VALUE	RANK	VALUE	RANK
≈ LAZARD	11.8	20	19.6	37	0.5	20
* S&P 500	-3.2	73	18.0	58	-0.2	
🔔 R 1000(R) GR	-11.3	96	22.8	18	-0.5	
☾ R 1000(R) VALUE	5.2	36	17.0	80	0.2	36
◆ R 2000(R)	4.0	39	23.9	16	0.2	40
MEDIAN	1.0		18.4		0.0	

VERMONT MUNICIPAL EMPLOYEES

COMBINED EQUITY FUNDS - TOTAL RATES OF RETURN

PERIODS ENDING 3/05

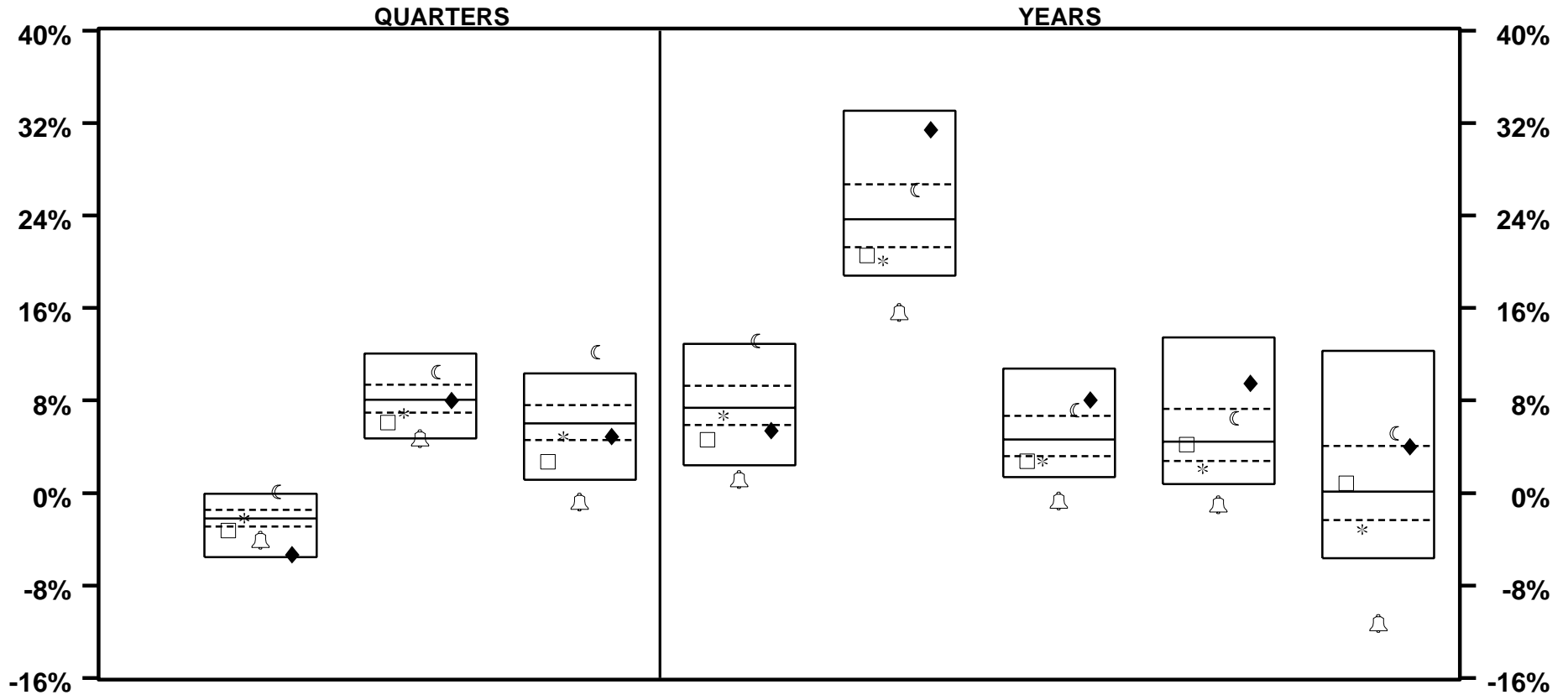

	LAST QTR		LAST 2 QTRS		LAST 3 QTRS		LAST YEAR		LAST 2 YEARS		LAST 3 YEARS		LAST 4 YEARS		LAST 5 YEARS	
□ EQTY COMPOSITE	-3.3	81	6.1	88	2.7	90	4.6	86	20.5	81	2.8	83	4.2	54	0.9	44
* S&P 500	-2.1	46	6.9	78	4.9	68	6.7	61	20.1	85	2.8	83	2.1	84	-3.2	83
🔔 R 1000(R) GR	-4.1	87	4.7	95	-0.8	97	1.2	96	15.6	98	-0.7	99	-1.0	98	-11.3	99
☾ R 1000(R) VALUE	0.1	4	10.5	14	12.2	2	13.2	4	26.2	29	7.2	20	6.5	30	5.2	19
◆ R 2000(R)	-5.3	93	8.0	50	4.9	67	5.4	78	31.4	8	8.0	14	9.5	14	4.0	25
MEDIAN	-2.2		8.1		6.0		7.4		23.7		4.6		4.5		0.1	

VERMONT MUNICIPAL EMPLOYEES

COMBINED EQUITY FUNDS - TOTAL RATES OF RETURN

PERIODS ENDING 3/05

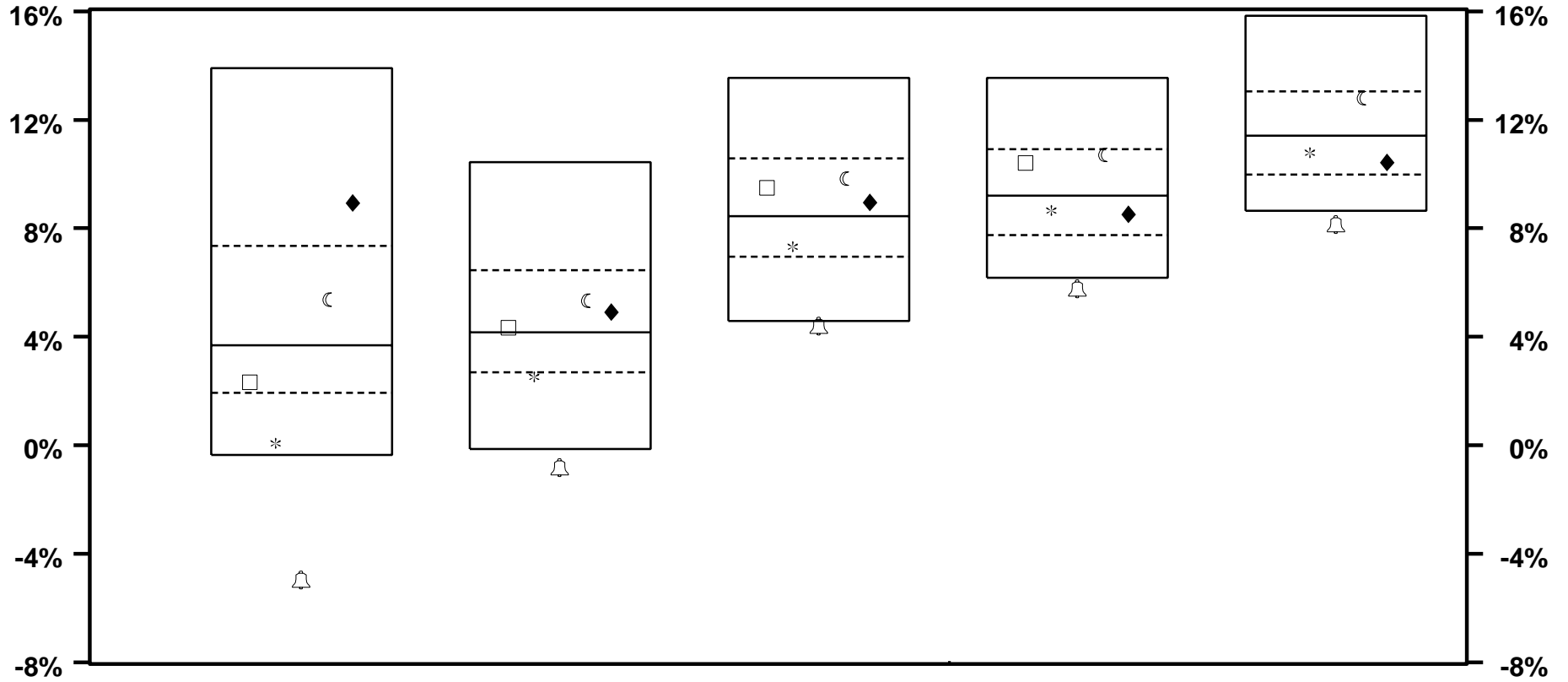

	LAST 6 YEARS		LAST 7 YEARS		LAST 8 YEARS		LAST 9 YEARS		LAST 10 YEARS	
□ EQTY COMPOSITE	2.3	69	4.3	46	9.5	34	10.4	31		
* S&P 500	0.1	91	2.5	77	7.3	71	8.7	59	10.8	63
🔔 R 1000(R) GR	-5.0	100	-0.8	98	4.4	98	5.8	97	8.1	97
☾ R 1000(R) VALUE	5.4	35	5.3	36	9.8	30	10.7	28	12.8	30
◆ R 2000(R)	8.9	15	4.9	41	9.0	42	8.5	61	10.4	68
MEDIAN	3.7		4.2		8.4		9.2		11.4	

VERMONT MUNICIPAL EMPLOYEES

COMBINED EQUITY FUNDS - TOTAL RATES OF RETURN

YEARS ENDING

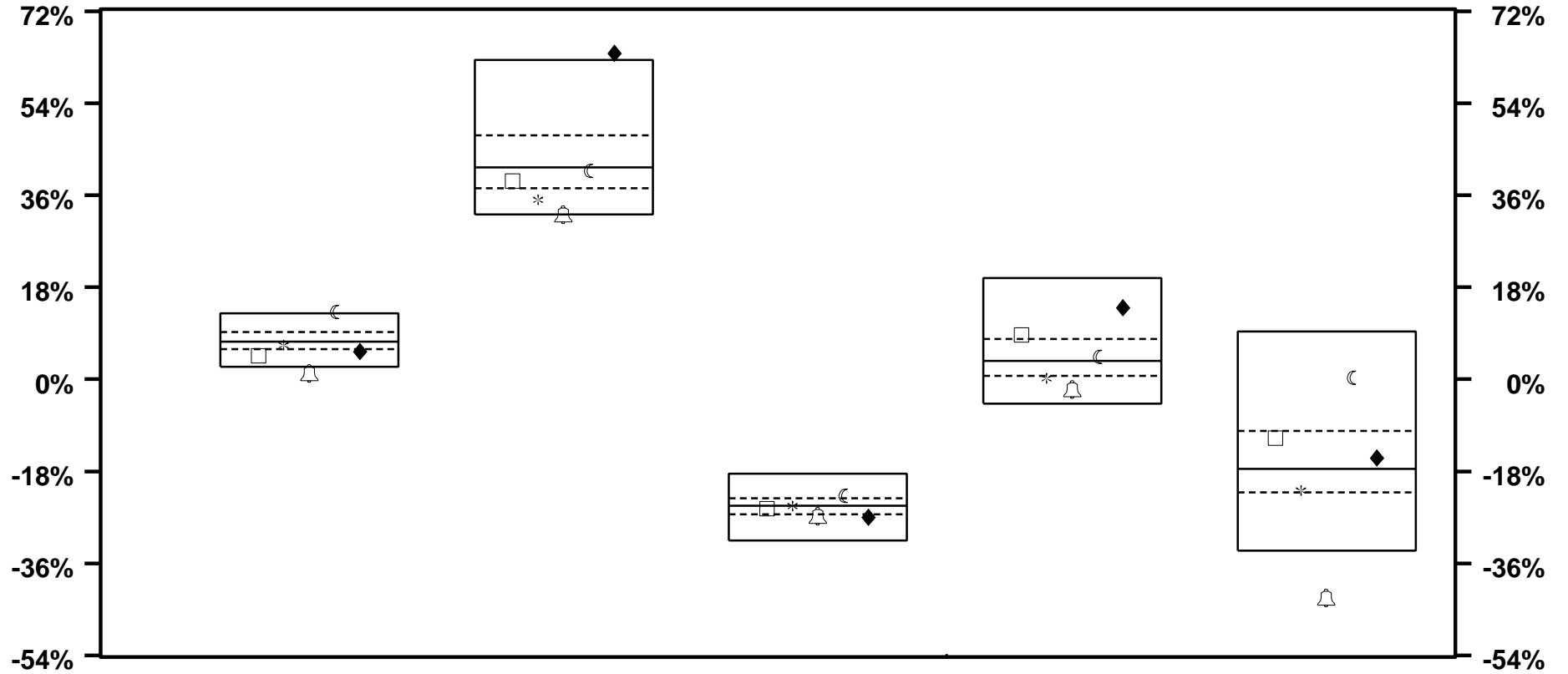

	3 / 05		3 / 04		3 / 03		3 / 02		3 / 01	
□ EQTY COMPOSITE	4.6	86	38.9	66	-25.3	60	8.7	22	-11.5	28
* S&P 500	6.7	61	35.1	85	-24.8	48	0.3	79	-21.7	71
🔔 R 1000(R) GR	1.2	96	32.2	95	-26.8	77	-2.0	89	-42.7	98
☾ R 1000(R) VALUE	13.2	4	40.8	53	-22.8	19	4.4	41	0.3	11
◆ R 2000(R)	5.4	78	63.8	4	-27.0	79	14.0	12	-15.3	41
MEDIAN	7.4		41.5		-24.8		3.6		-17.5	

VERMONT MUNICIPAL EMPLOYEES

COMBINED EQUITY FUNDS - TOTAL RATES OF RETURN

YEARS ENDING

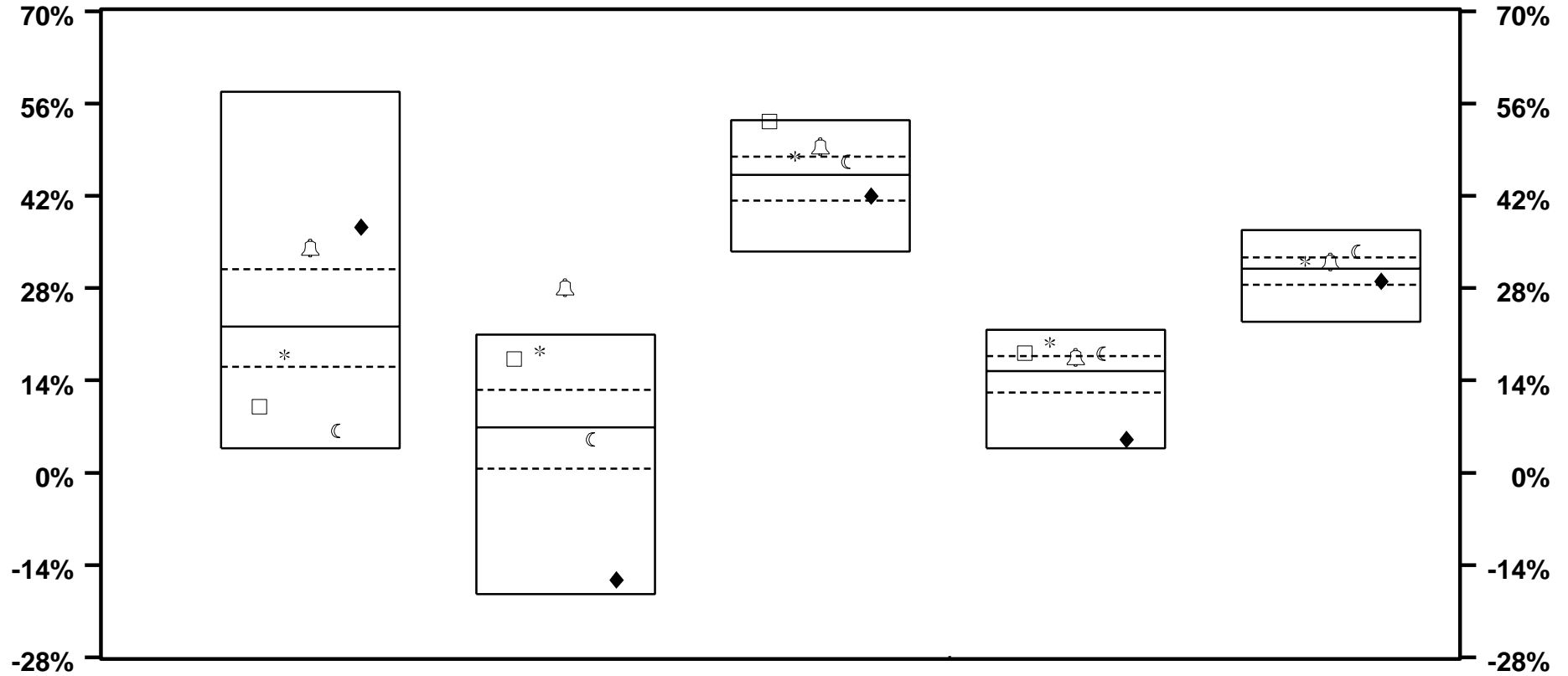

	3 / 00		3 / 99		3 / 98		3 / 97		3 / 96	
□ EQTY COMPOSITE	10.1	88	17.3	12	53.3	5	18.1	23		
* S&P 500	18.0	67	18.5	9	48.0	24	19.8	10	32.0	34
⌚ R 1000(R) GR	34.1	20	28.1	1	49.5	13	17.5	25	32.0	34
☾ R 1000(R) VALUE	6.3	91	5.0	59	47.2	31	18.1	23	33.5	18
◆ R 2000(R)	37.3	17	-16.3	93	42.0	70	5.1	93	29.0	70
MEDIAN	22.1		6.9		45.2		15.4		30.9	

VERMONT MUNICIPAL EMPLOYEES COMBINED EQUITY FUNDS - TOTAL RETURN VS RISK 3 YEARS ENDING 3/05

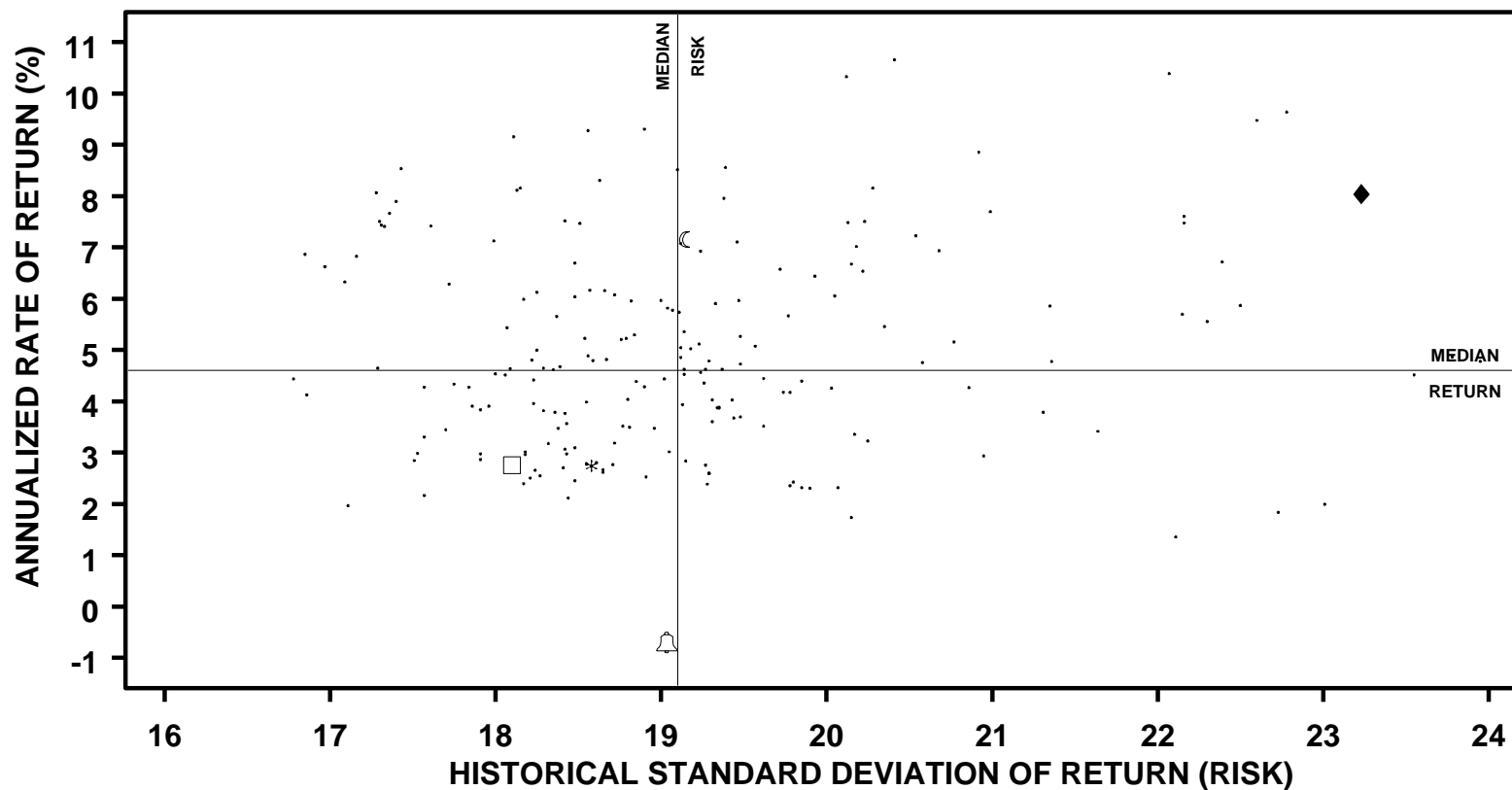

	ANNUALIZED RETURN		STANDARD DEVIATION		SHARPE RATIO	
	VALUE	RANK	VALUE	RANK	VALUE	RANK
□ EQTY COMPOSITE	2.8	83	18.1	80	0.2	82
* S&P 500	2.8	83	18.6	62	0.2	81
🔔 R 1000(R) GR	-0.7	99	19.0	51	0.0	
☾ R 1000(R) VALUE	7.2	20	19.1	47	0.4	20
◆ R 2000(R)	8.0	14	23.2	7	0.4	19
MEDIAN	4.6		19.1		0.3	

VERMONT MUNICIPAL EMPLOYEES

COMBINED EQUITY FUNDS - TOTAL RETURN VS RISK

5 YEARS ENDING 3/05

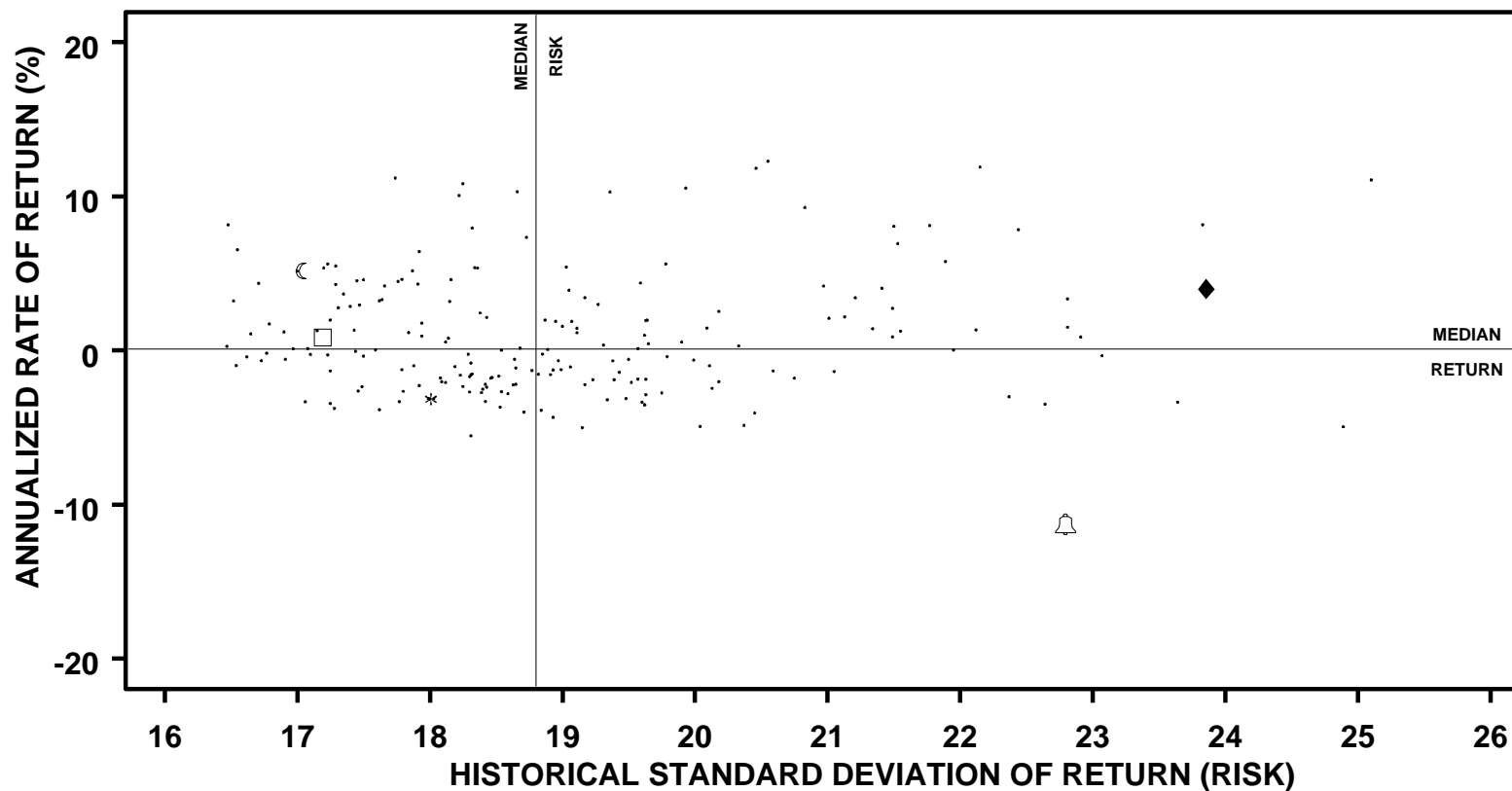

	ANNUALIZED RETURN		STANDARD DEVIATION		SHARPE RATIO	
	VALUE	RANK	VALUE	RANK	VALUE	RANK
□ EQTY COMPOSITE	0.9	44	17.2	86	0.0	
* S&P 500	-3.2	83	18.0	68	-0.2	
🔔 R 1000(R) GR	-11.3	99	22.8	11	-0.5	
☾ R 1000(R) VALUE	5.2	19	17.0	88	0.2	18
◆ R 2000(R)	4.0	25	23.9	8	0.2	24
MEDIAN	0.1		18.8		-0.1	

VERMONT MUNICIPAL EMPLOYEES

BOND FUNDS - TOTAL RATES OF RETURN

PERIODS ENDING 3/05

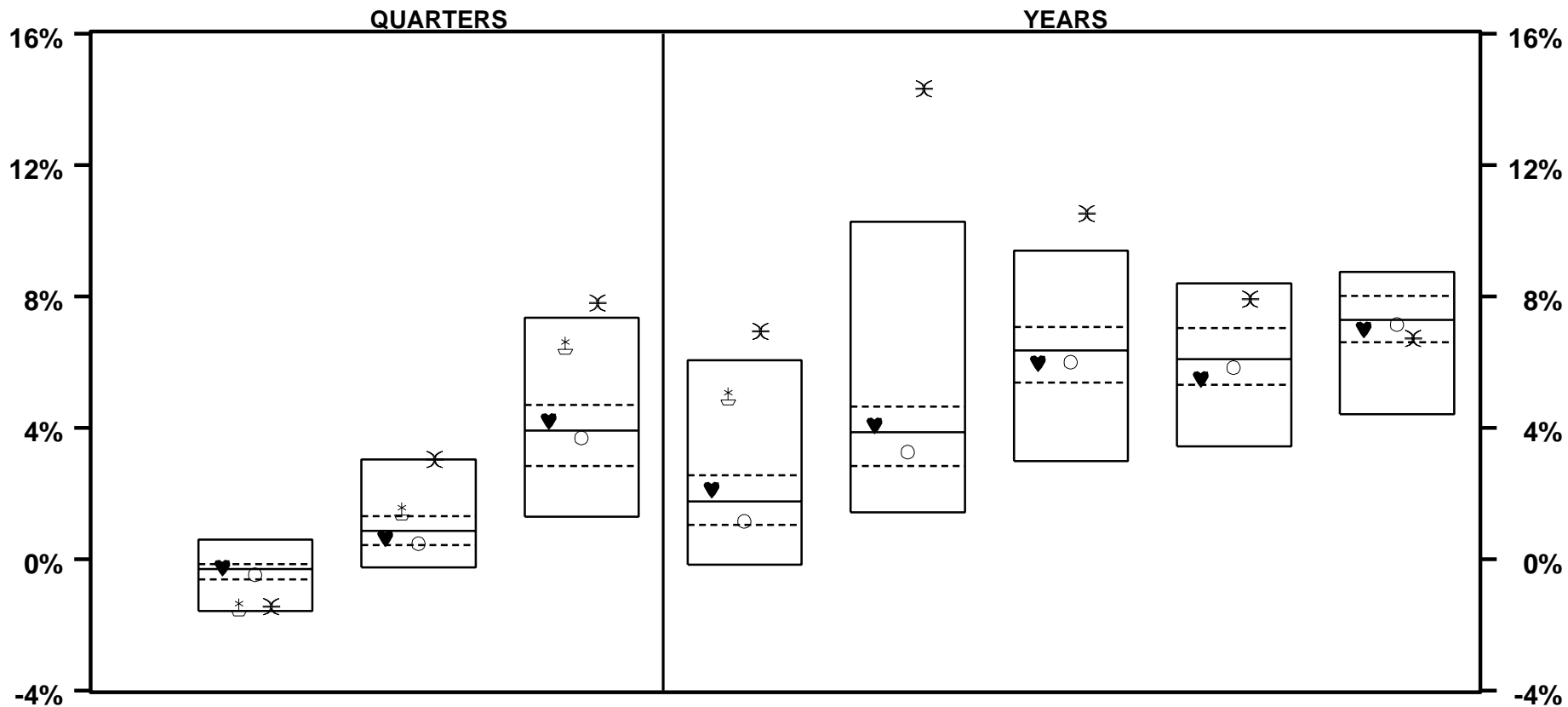

	LAST QTR		LAST 2 QTRS		LAST 3 QTRS		LAST YEAR		LAST 2 YEARS		LAST 3 YEARS		LAST 4 YEARS		LAST 5 YEARS	
♥ SEIX CORE	-0.3	44	0.6	60	4.2	42	2.1	40	4.1	46	6.0	61	5.5	69	7.0	63
☆ SEIX HIGH YIELD	-1.5	93	1.5	18	6.5	7	5.0	7								
○ LB AGGREGATE	-0.5	66	0.5	70	3.7	58	1.2	69	3.3	63	6.0	60	5.8	58	7.1	56
✕ ML HIGH YLD II	-1.4	93	3.0	4	7.8	3	6.9	2	14.3	1	10.5	2	7.9	7	6.7	72
MEDIAN	-0.3		0.9		3.9		1.8		3.9		6.4		6.1		7.3	

VERMONT MUNICIPAL EMPLOYEES

BOND FUNDS - TOTAL RATES OF RETURN

YEARS ENDING

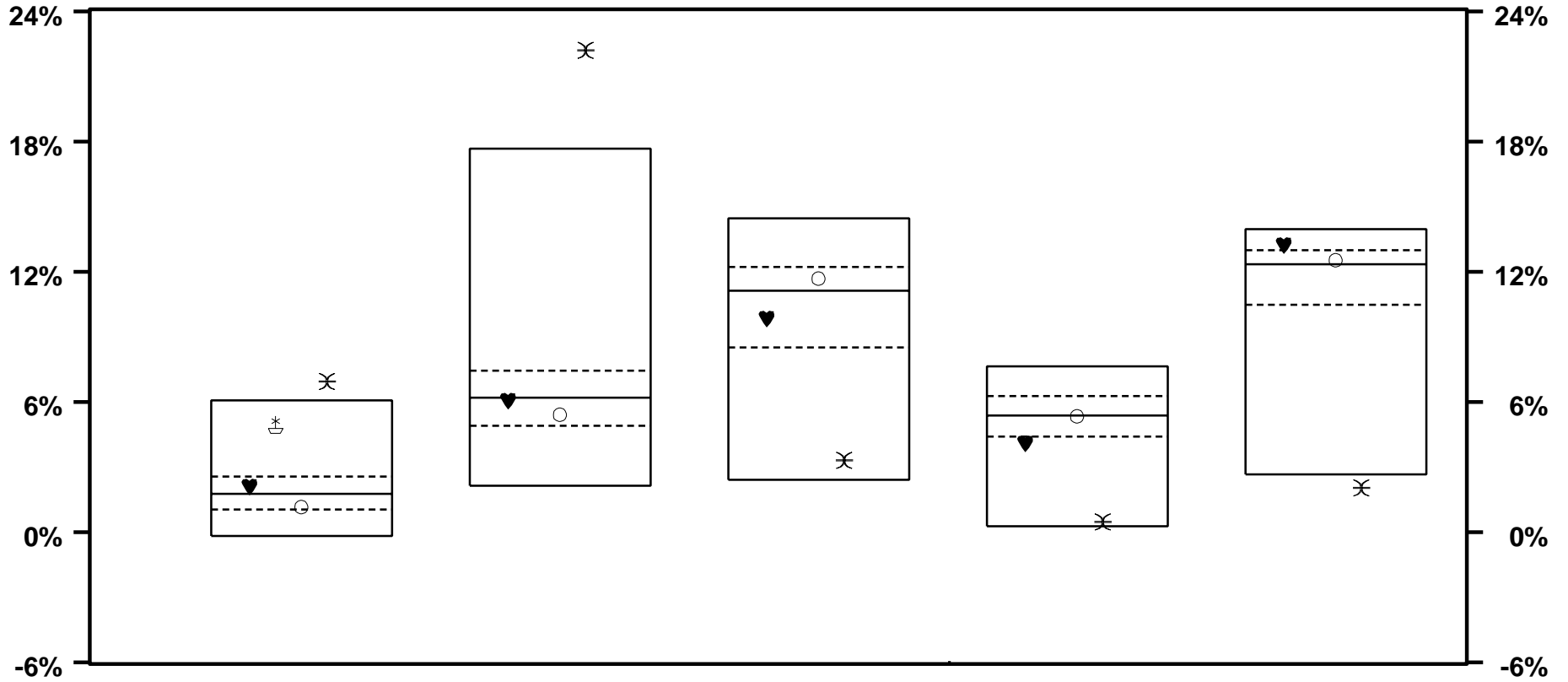

	3 / 05		3 / 04		3 / 03		3 / 02		3 / 01	
♥ SEIX CORE	2.1	40	6.1	52	9.8	63	4.1	78	13.2	17
♣ SEIX HIGH YIELD	5.0	7								
○ LB AGGREGATE	1.2	69	5.4	65	11.7	40	5.3	51	12.5	42
✕ ML HIGH YLD II	6.9	2	22.2	2	3.3	93	0.5	94	2.0	95
MEDIAN	1.8		6.2		11.1		5.4		12.3	

VERMONT MUNICIPAL EMPLOYEES

BOND FUNDS - TOTAL VS BOND ONLY RETURNS

MARKET CYCLE PERFORMANCE COMPARISONS

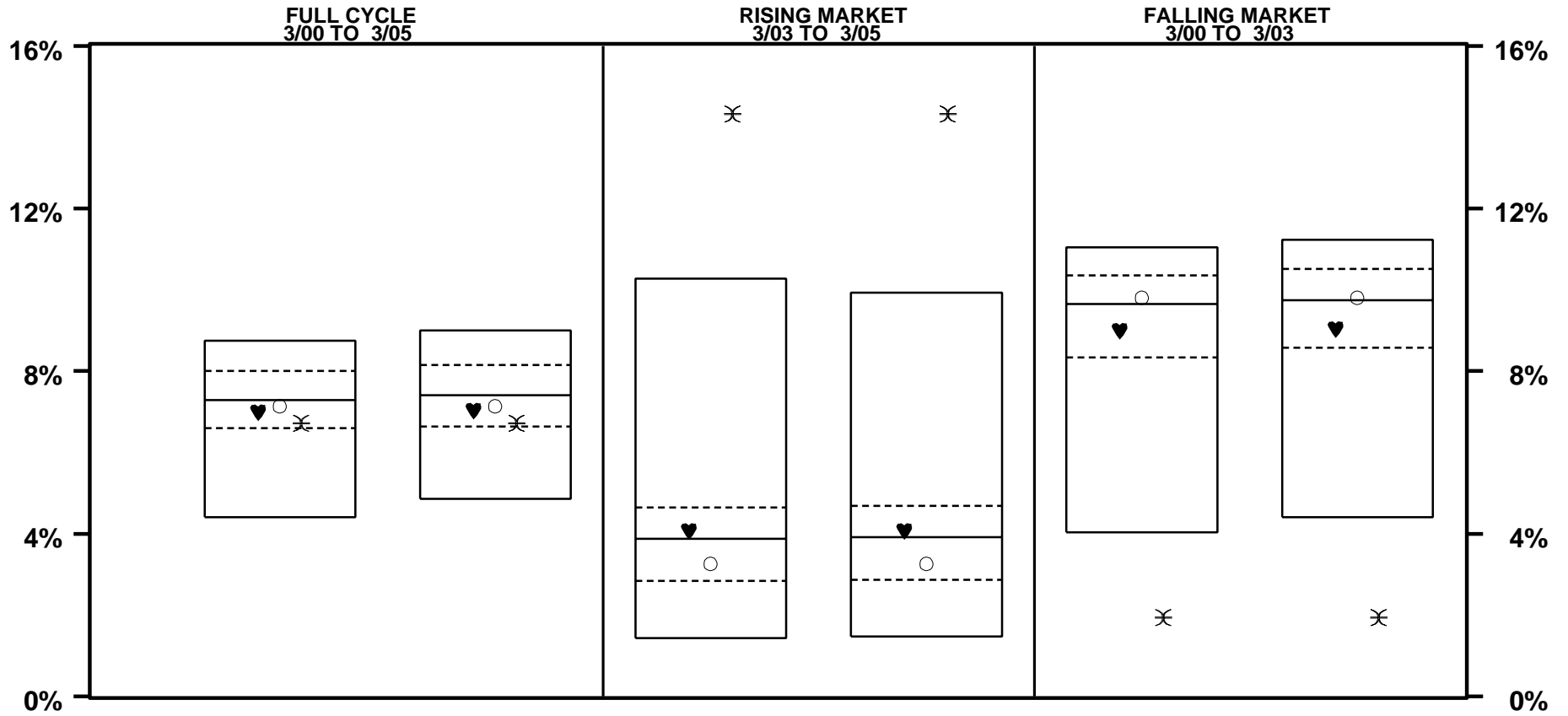

	TOTAL FUND		BONDS ONLY		TOTAL FUND		BONDS ONLY		TOTAL FUND		BONDS ONLY	
♥ SEIX CORE	7.0	63	7.0	64	4.1	46	4.1	47	9.0	66	9.0	67
○ LB AGGREGATE	7.1	56	7.1	60	3.3	63	3.3	63	9.8	44	9.8	47
⌘ ML HIGH YLD II	6.7	72	6.7	72	14.3	1	14.3	1	1.9	97	1.9	97
MEDIAN	7.3		7.4		3.9		3.9		9.7		9.7	

VERMONT MUNICIPAL EMPLOYEES

BOND FUNDS - TOTAL FUND INCOME RATES OF RETURN FOR PERIOD ENDING 3/05

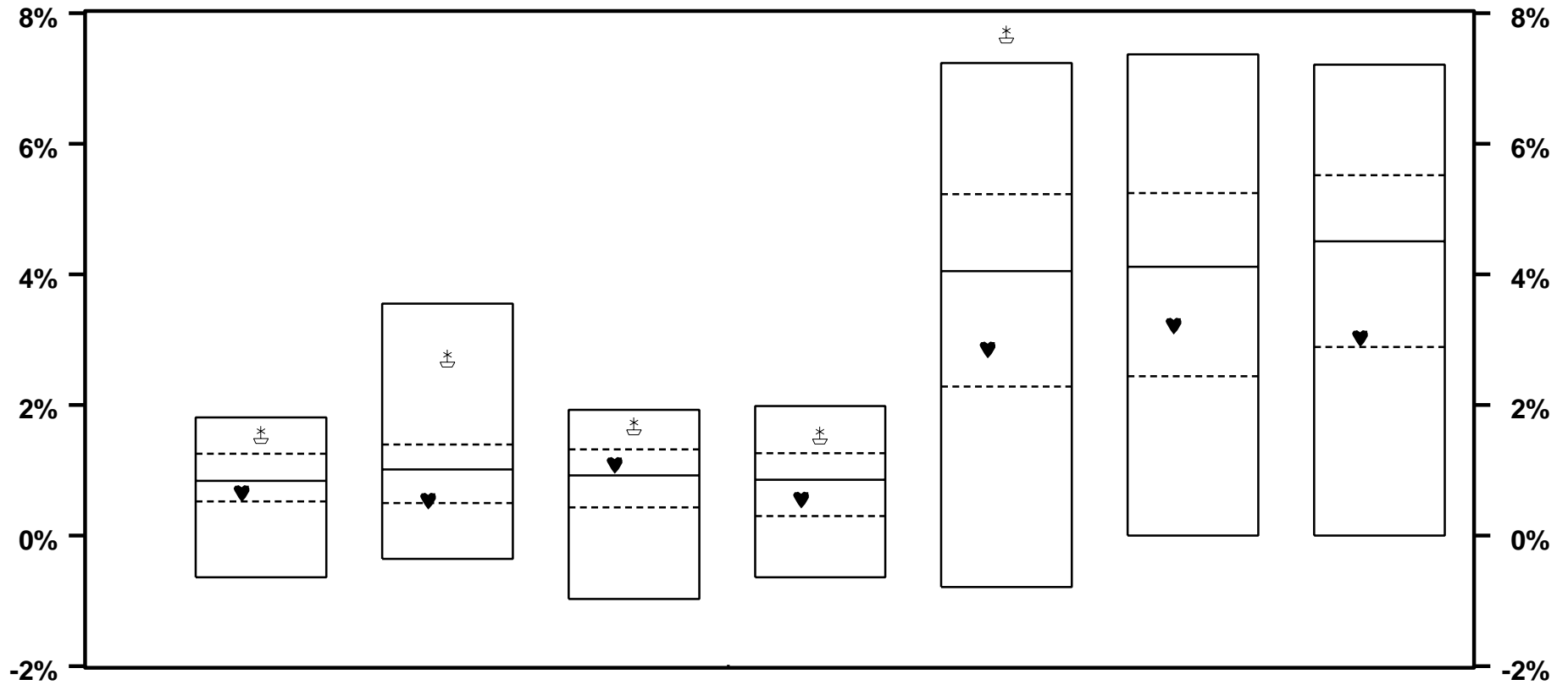

	THIS QUARTER	LAST QUARTER	2 QTRS AGO	3 QTRS AGO	LAST YEAR	LAST 2 YEARS	LAST 3 YEARS
♥ SEIX CORE	0.7 60	0.5 74	1.1 40	0.5 68	2.9 65	3.2 62	3.0 73
☺ SEIX HIGH YIELD	1.5 10	2.7 7	1.7 10	1.5 13	7.7 3		
MEDIAN	0.8	1.0	0.9	0.8	4.0	4.1	4.5

VERMONT MUNICIPAL EMPLOYEES

BOND FUNDS - TOTAL RETURN VS RISK

3 YEARS ENDING 3/05

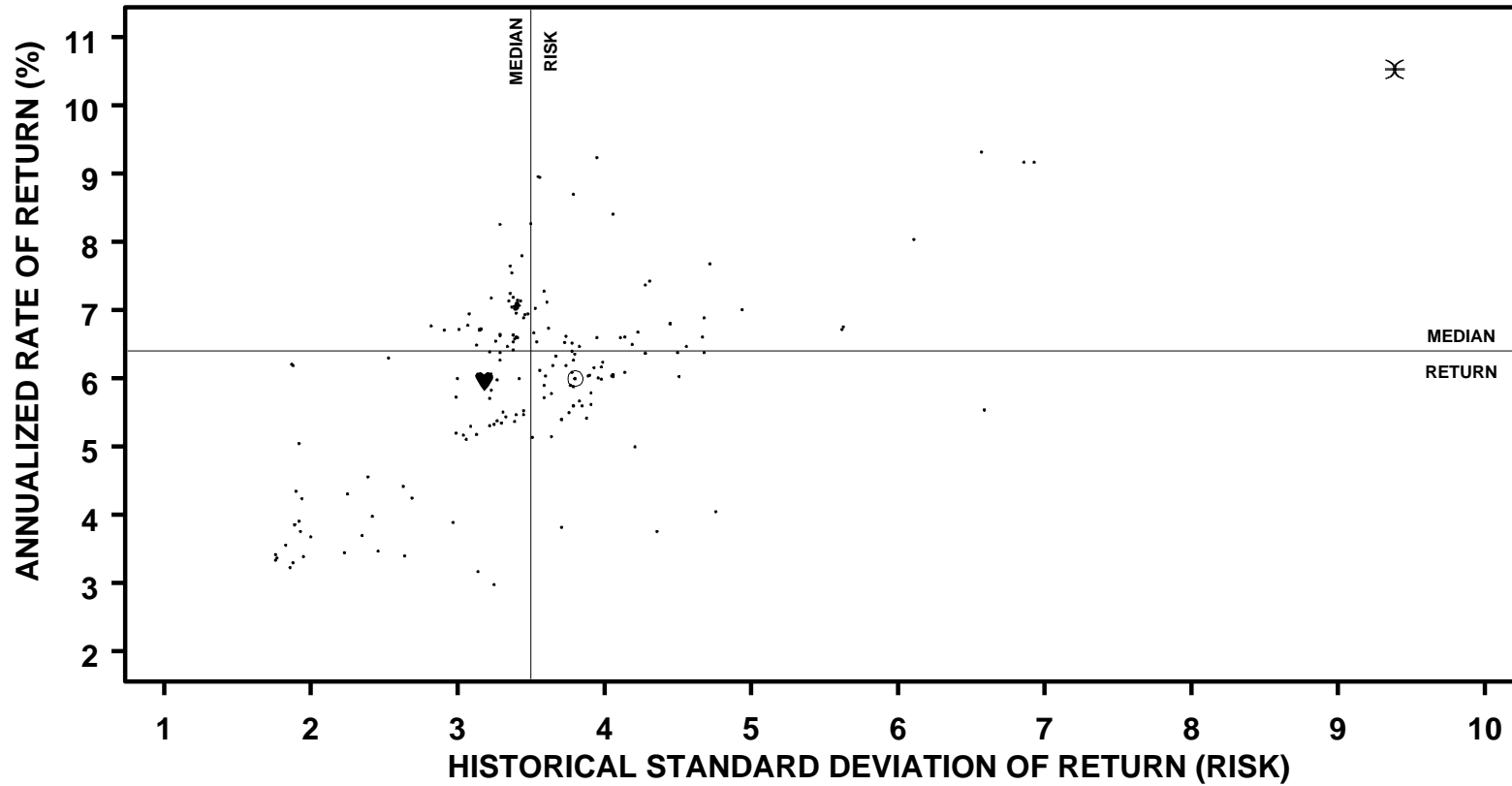

	ANNUALIZED RETURN		STANDARD DEVIATION		SHARPE RATIO	
	VALUE	RANK	VALUE	RANK	VALUE	RANK
♥ SEIX CORE	6.0	61	3.2	78	1.4	39
○ LB AGGREGATE	6.0	60	3.8	33	1.2	56
⌘ ML HIGH YLD II	10.5	2	9.4	1	1.0	83
MEDIAN	6.4		3.5		1.2	

VERMONT MUNICIPAL EMPLOYEES

BOND FUNDS - TOTAL RETURN VS RISK

5 YEARS ENDING 3/05

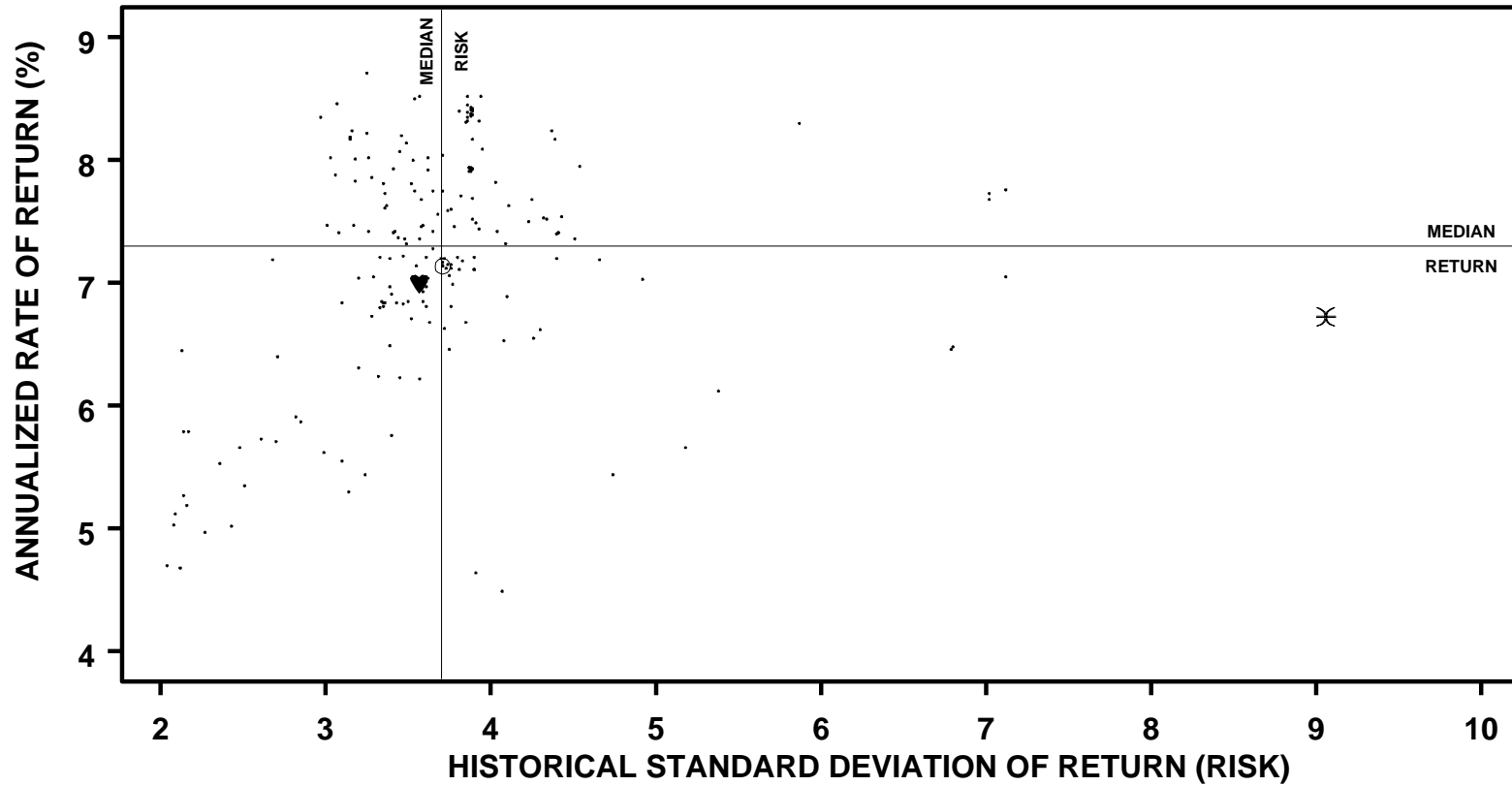

	ANNUALIZED RETURN		STANDARD DEVIATION		SHARPE RATIO	
	VALUE	RANK	VALUE	RANK	VALUE	RANK
♥ SEIX CORE	7.0	63	3.6	62	1.2	50
○ LB AGGREGATE	7.1	56	3.7	51	1.1	52
⊗ ML HIGH YLD II	6.7	72	9.1	1	0.5	95
MEDIAN	7.3		3.7		1.2	

VERMONT MUNICIPAL EMPLOYEES

BOND ONLY - RATES OF RETURN

PERIODS ENDING 3/05

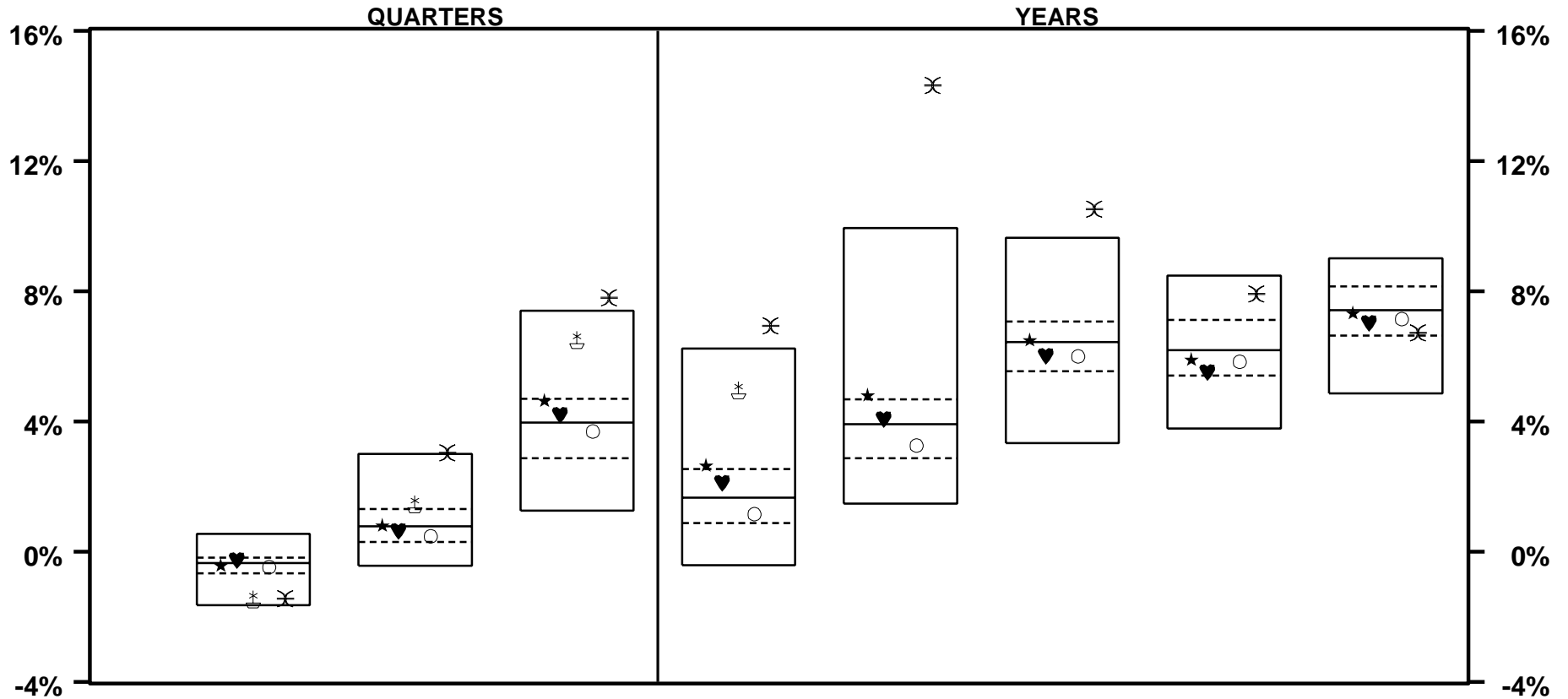

	LAST QTR		LAST 2 QTRS		LAST 3 QTRS		LAST YEAR		LAST 2 YEARS		LAST 3 YEARS		LAST 4 YEARS		LAST 5 YEARS	
★ MUNI COMPOSITE	-0.4	54	0.8	47	4.6	31	2.6	21	4.8	22	6.5	48	5.9	58	7.3	52
♥ SEIX CORE	-0.3	39	0.6	55	4.2	43	2.1	38	4.1	47	6.0	62	5.5	71	7.0	64
⊠ SEIX HIGH YIELD	-1.5	92	1.5	18	6.5	7	5.0	7								
○ LB AGGREGATE	-0.5	60	0.5	65	3.7	58	1.2	66	3.3	63	6.0	63	5.8	61	7.1	60
* ML HIGH YLD II	-1.4	92	3.0	4	7.8	4	6.9	3	14.3	1	10.5	2	7.9	8	6.7	72
MEDIAN	-0.4		0.8		4.0		1.7		3.9		6.4		6.2		7.4	

VERMONT MUNICIPAL EMPLOYEES

BOND ONLY - RATES OF RETURN

PERIODS ENDING 3/05

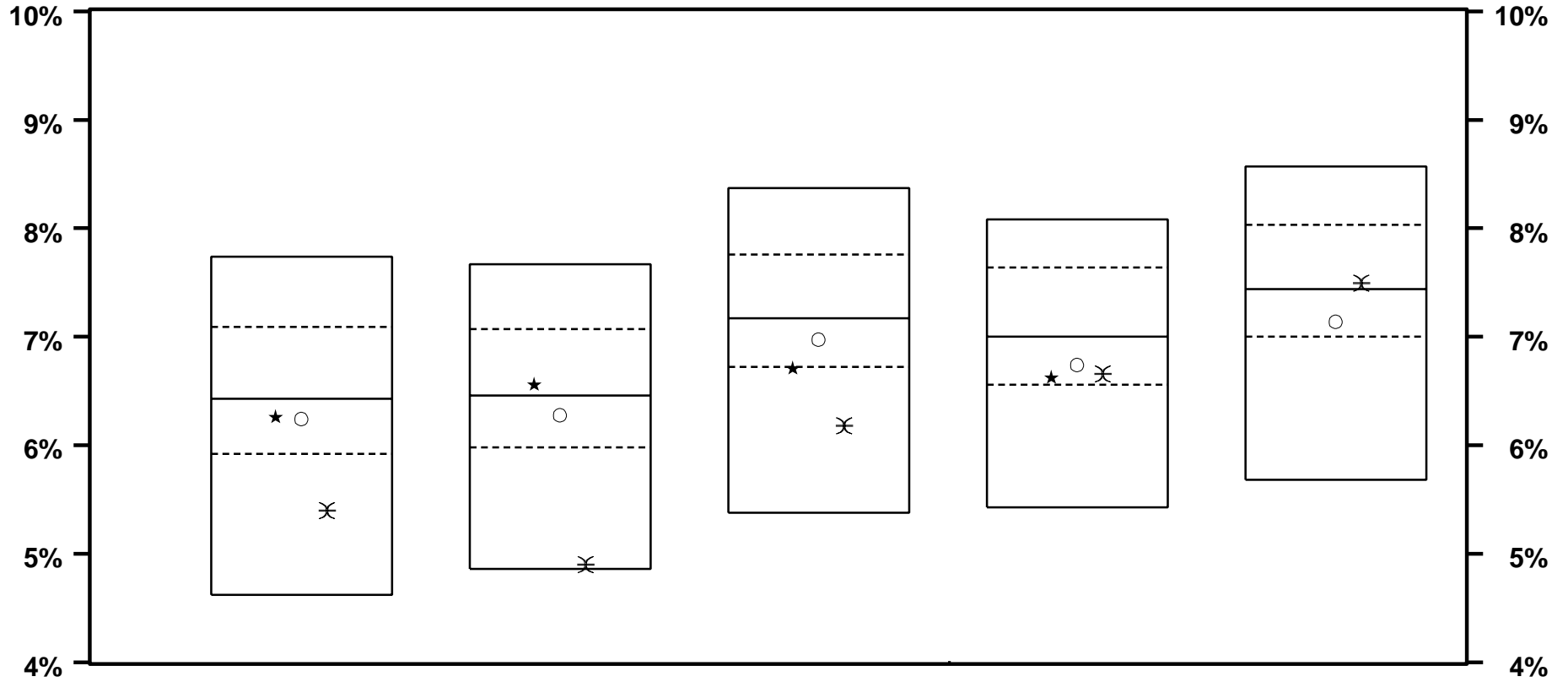

	LAST 6 YEARS		LAST 7 YEARS		LAST 8 YEARS		LAST 9 YEARS		LAST 10 YEARS	
★ MUNI COMPOSITE	6.3	58	6.6	44	6.7	75	6.6	72		
○ LB AGGREGATE	6.2	59	6.3	60	7.0	60	6.7	63	7.1	64
✕ ML HIGH YLD II	5.4	86	4.9	94	6.2	86	6.7	70	7.5	46
MEDIAN	6.4		6.5		7.2		7.0		7.4	

VERMONT MUNICIPAL EMPLOYEES

BOND ONLY - RATES OF RETURN

YEARS ENDING

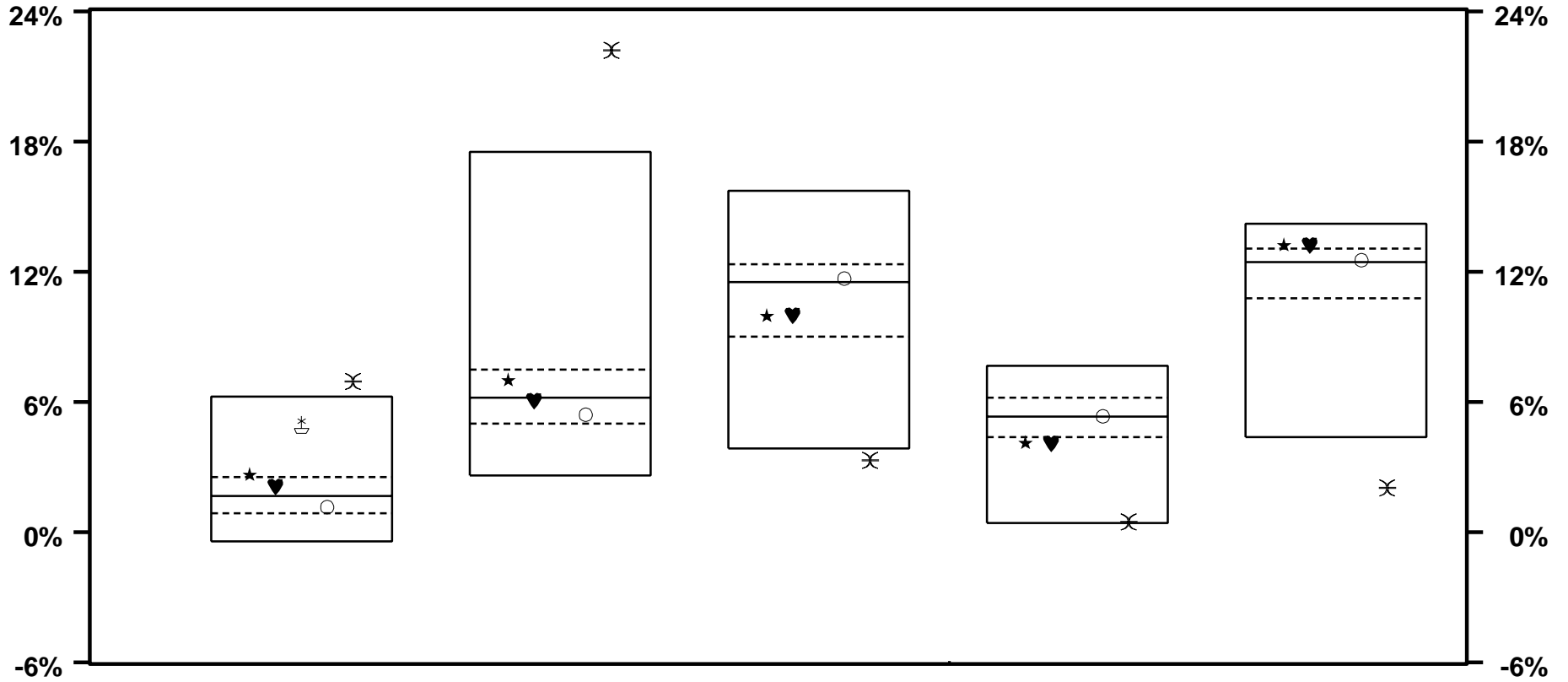

	3 / 05		3 / 04		3 / 03		3 / 02		3 / 01	
★ MUNI COMPOSITE	2.6	21	7.0	28	10.0	67	4.1	78	13.2	19
♥ SEIX CORE	2.1	38	6.1	53	10.0	66	4.1	79	13.2	19
⊕ SEIX HIGH YIELD	5.0	7								
○ LB AGGREGATE	1.2	66	5.4	66	11.7	46	5.3	49	12.5	46
✕ ML HIGH YLD II	6.9	3	22.2	1	3.3	95	0.5	94	2.0	96
MEDIAN	1.7		6.2		11.5		5.3		12.4	

VERMONT MUNICIPAL EMPLOYEES

BOND ONLY - RATES OF RETURN

YEARS ENDING

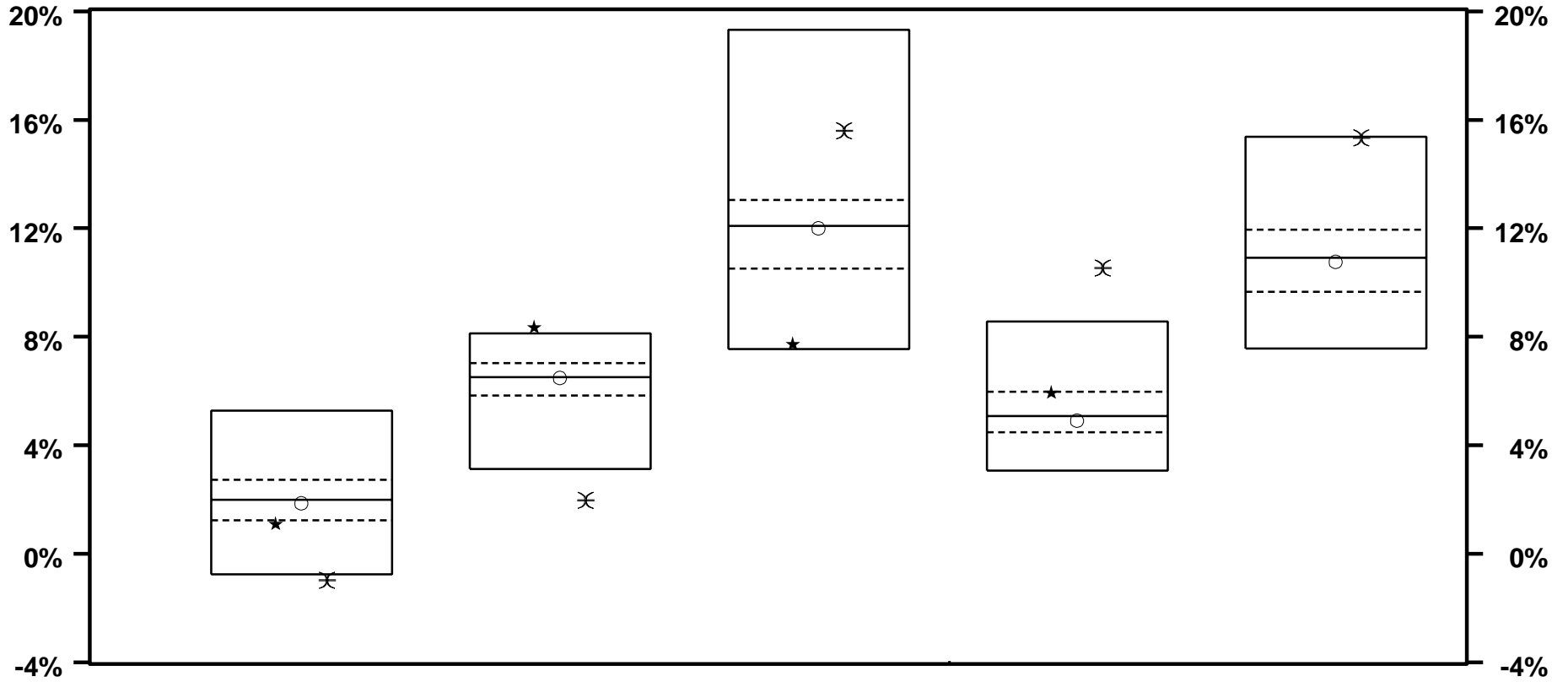

	3 / 00		3 / 99		3 / 98		3 / 97		3 / 96	
★ MUNI COMPOSITE	1.1	77	8.4	3	7.8	94	6.0	25		
○ LB AGGREGATE	1.9	54	6.5	51	12.0	53	4.9	56	10.8	53
✕ ML HIGH YLD II	-1.0	95	2.0	96	15.6	9	10.5	3	15.3	5
MEDIAN	2.0		6.5		12.1		5.1		10.9	

VERMONT MUNICIPAL EMPLOYEES

BOND ONLY RETURNS VS RISK

3 YEARS ENDING 3/05

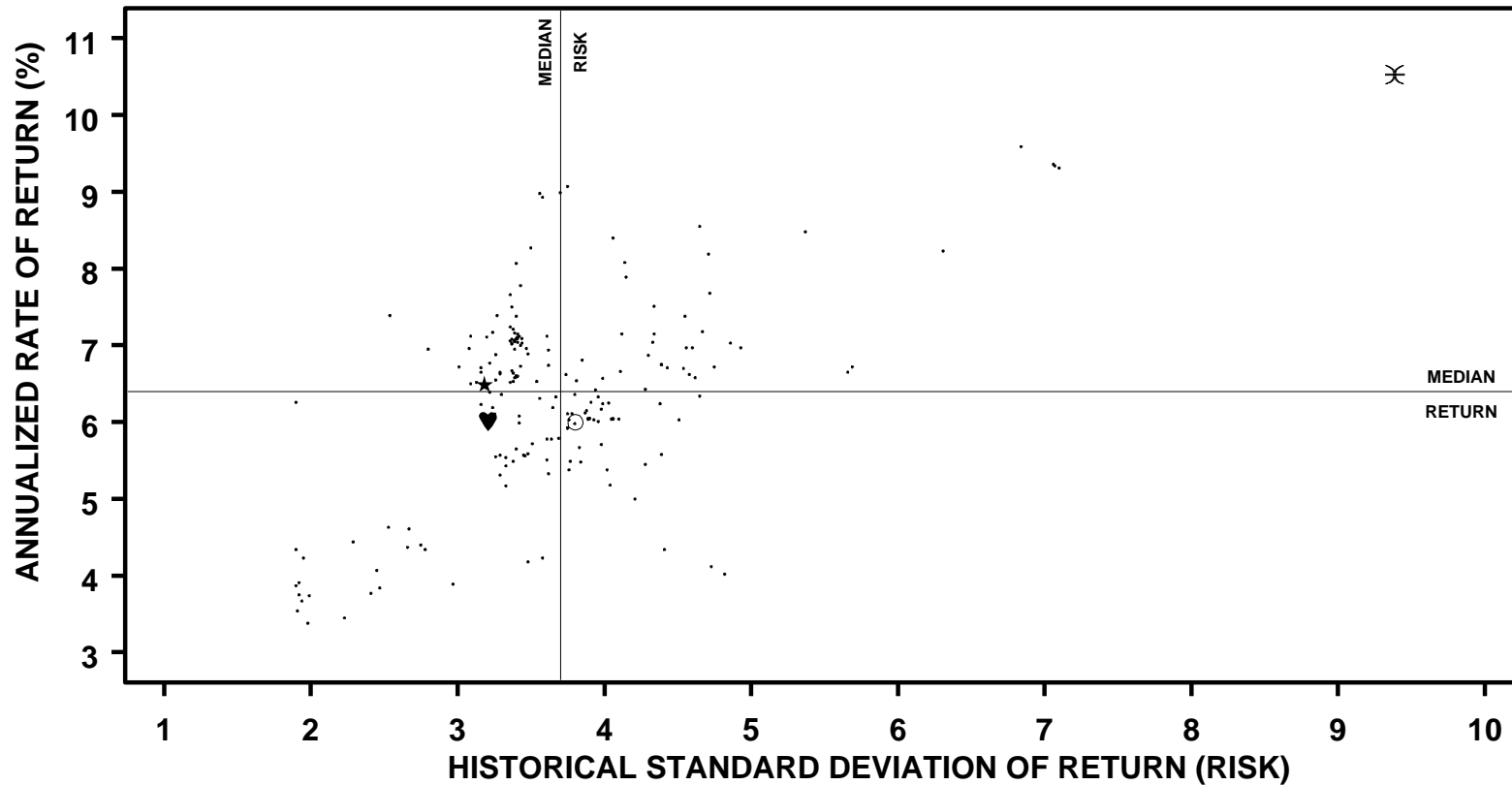

	ANNUALIZED RETURN		STANDARD DEVIATION		SHARPE RATIO	
	VALUE	RANK	VALUE	RANK	VALUE	RANK
★ MUNI COMPOSITE	6.5	48	3.2	81	1.5	24
♥ SEIX CORE	6.0	62	3.2	81	1.4	37
○ LB AGGREGATE	6.0	63	3.8	43	1.2	55
⌘ ML HIGH YLD II	10.5	2	9.4	1	1.0	82
MEDIAN	6.4		3.7		1.2	

VERMONT MUNICIPAL EMPLOYEES

BOND ONLY RETURNS VS RISK

5 YEARS ENDING 3/05

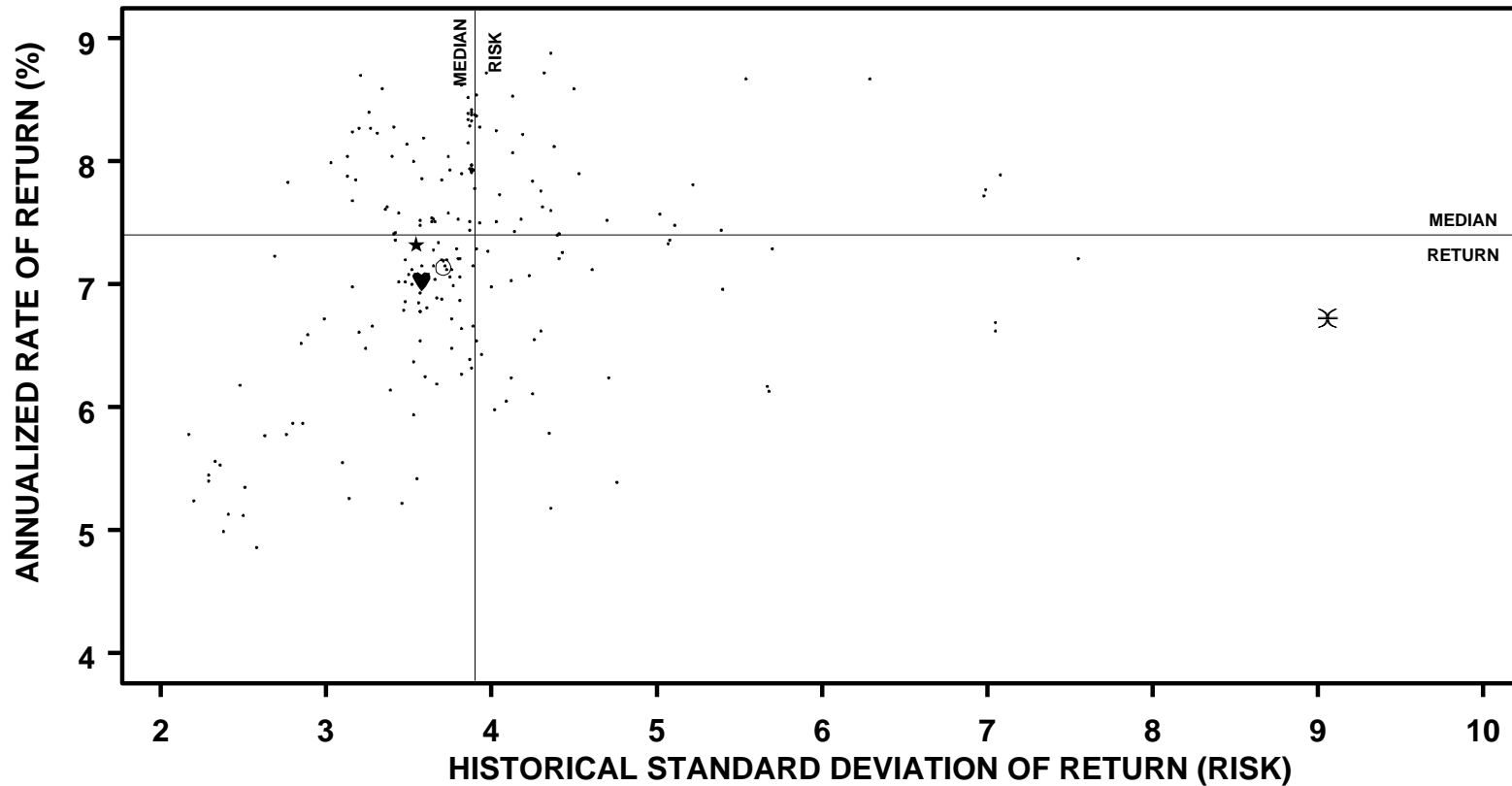

	ANNUALIZED RETURN		STANDARD DEVIATION		SHARPE RATIO	
	VALUE	RANK	VALUE	RANK	VALUE	RANK
★ MUNI COMPOSITE	7.3	52	3.5	70	1.3	36
♥ SEIX CORE	7.0	64	3.6	67	1.2	48
○ LB AGGREGATE	7.1	60	3.7	60	1.1	50
⌘ ML HIGH YLD II	6.7	72	9.1	2	0.5	95
MEDIAN	7.4		3.9		1.2	

VERMONT MUNICIPAL EMPLOYEES

CASH FUNDS - TOTAL RATES OF RETURN

PERIODS ENDING 3/05

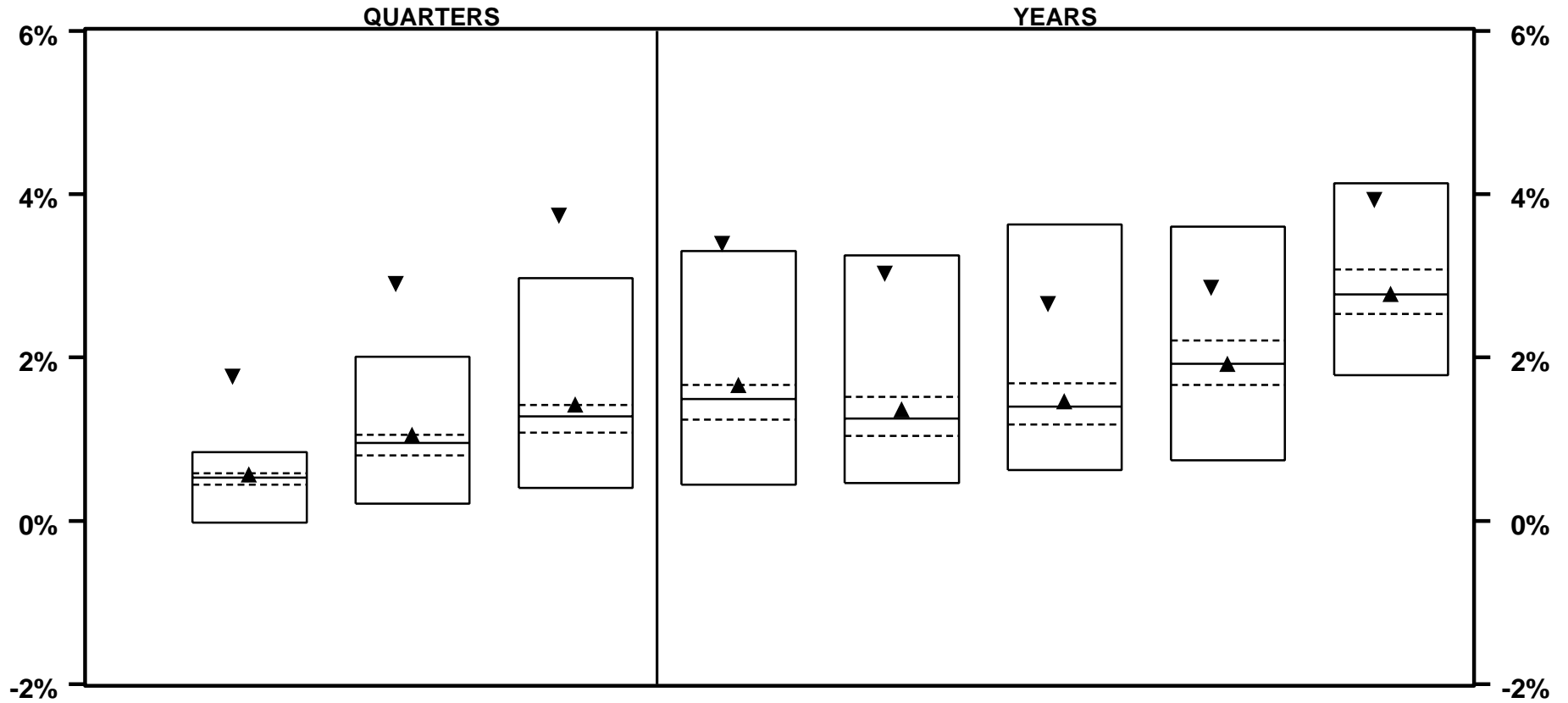

	LAST QTR		LAST 2 QTRS		LAST 3 QTRS		LAST YEAR		LAST 2 YEARS		LAST 3 YEARS		LAST 4 YEARS		LAST 5 YEARS	
▼ VERMONT INVEST	1.8	1	2.9	3	3.7	3	3.4	4	3.0	6	2.7	9	2.9	11	3.9	9
▲ 90 DAY T-BILLS	0.6	27	1.1	22	1.4	23	1.7	22	1.4	33	1.5	43	1.9	48	2.8	48
MEDIAN	0.5		1.0		1.3		1.5		1.3		1.4		1.9		2.8	

VERMONT MUNICIPAL EMPLOYEES

CASH FUNDS - TOTAL RATES OF RETURN

PERIODS ENDING 3/05

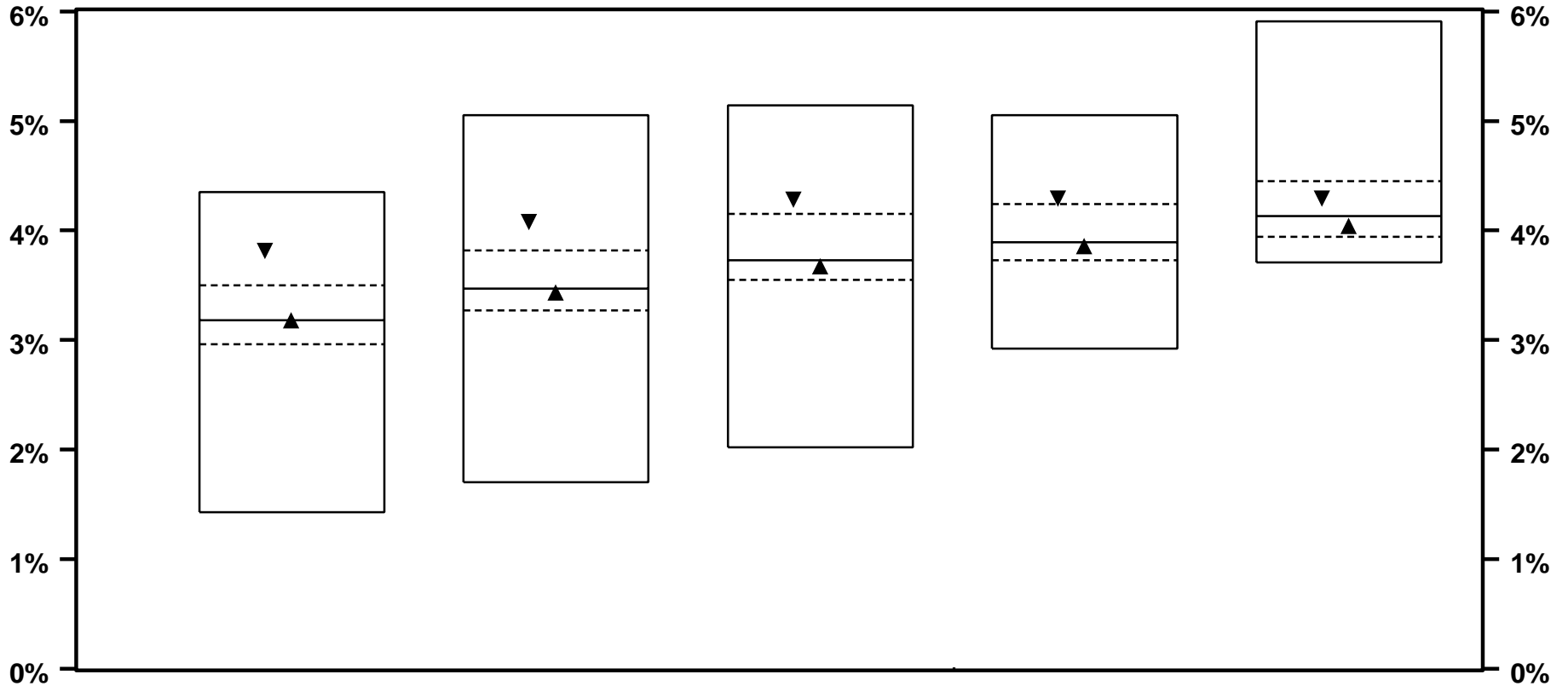

	LAST 6 YEARS	LAST 7 YEARS	LAST 8 YEARS	LAST 9 YEARS	LAST 10 YEARS
▼ VERMONT INVEST	3.8 14	4.1 18	4.3 20	4.3 22	4.3 35
▲ 90 DAY T-BILLS	3.2 49	3.4 54	3.7 56	3.9 53	4.0 58
MEDIAN	3.2	3.5	3.7	3.9	4.1

VERMONT MUNICIPAL EMPLOYEES

CASH FUNDS - TOTAL RATES OF RETURN

YEARS ENDING

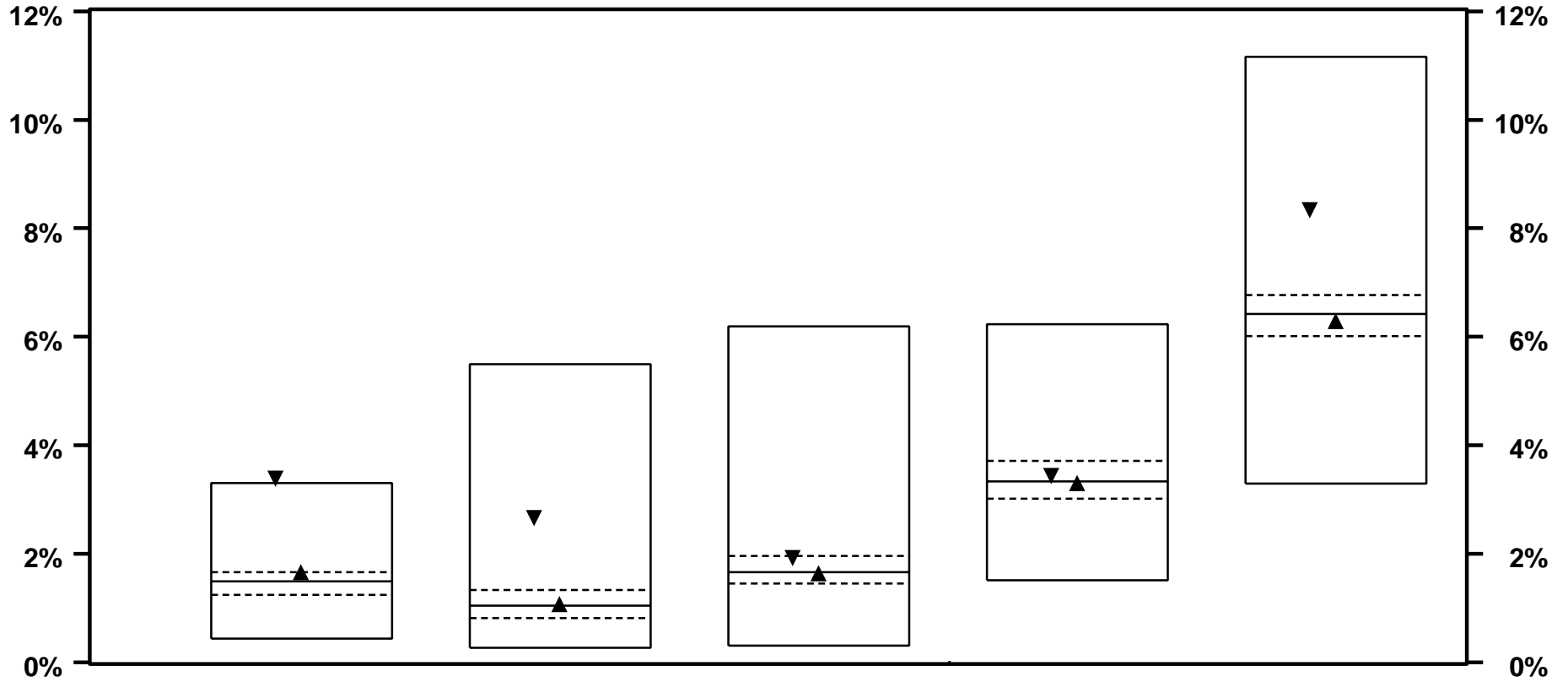

	3 / 05		3 / 04		3 / 03		3 / 02		3 / 01	
▼ VERMONT INVEST	3.4	4	2.7	10	1.9	25	3.4	39	8.3	11
▲ 90 DAY T-BILLS	1.7	22	1.1	43	1.7	51	3.3	51	6.3	59
MEDIAN	1.5		1.0		1.7		3.3		6.4	

VERMONT MUNICIPAL EMPLOYEES

CASH FUNDS - TOTAL RATES OF RETURN

YEARS ENDING

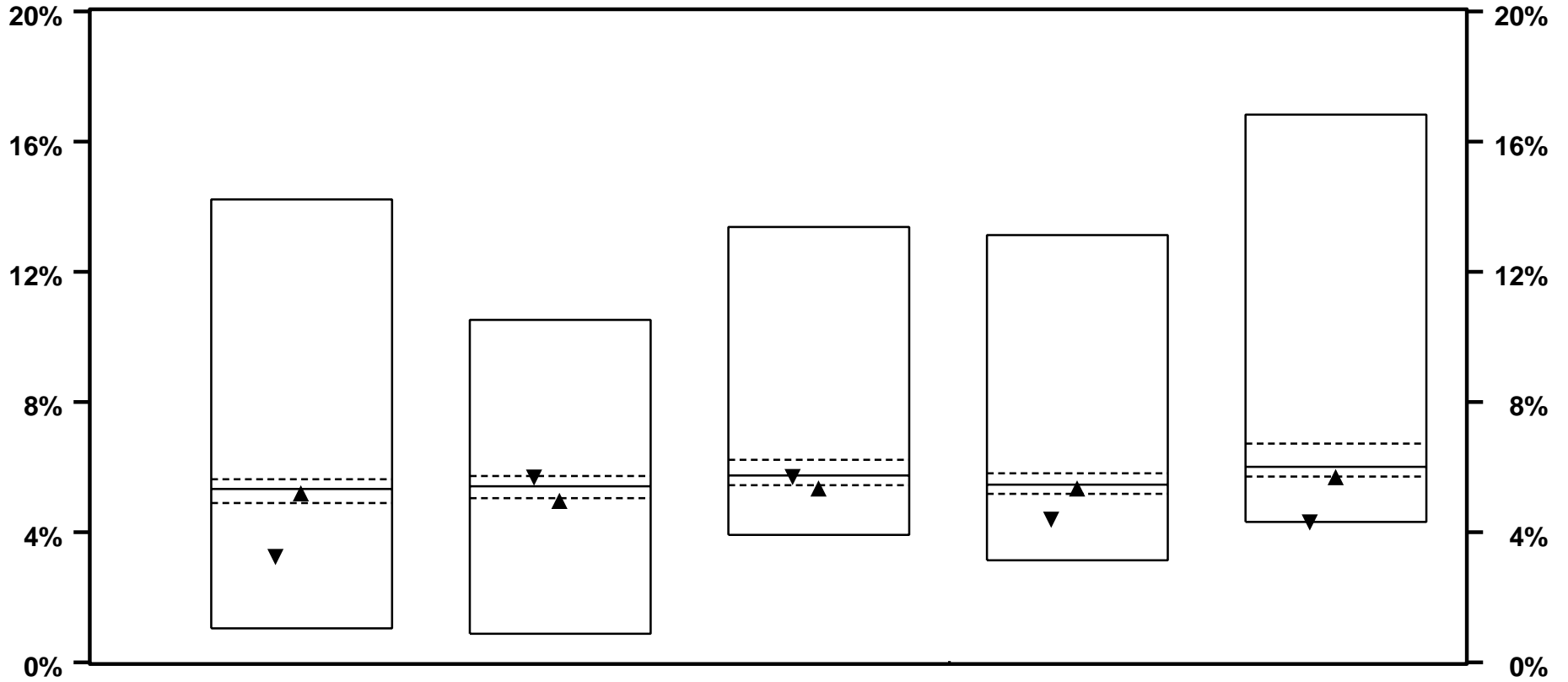

	3 / 00		3 / 99		3 / 98		3 / 97		3 / 96	
▼ VERMONT INVEST	3.2	90	5.7	26	5.7	53	4.4	92	4.3	95
▲ 90 DAY T-BILLS	5.2	58	5.0	77	5.4	80	5.4	61	5.7	74
MEDIAN	5.3		5.4		5.7		5.5		6.0	

VERMONT MUNICIPAL EMPLOYEES

CASH EQUIVALENTS - RATES OF RETURN

PERIODS ENDING 3/05

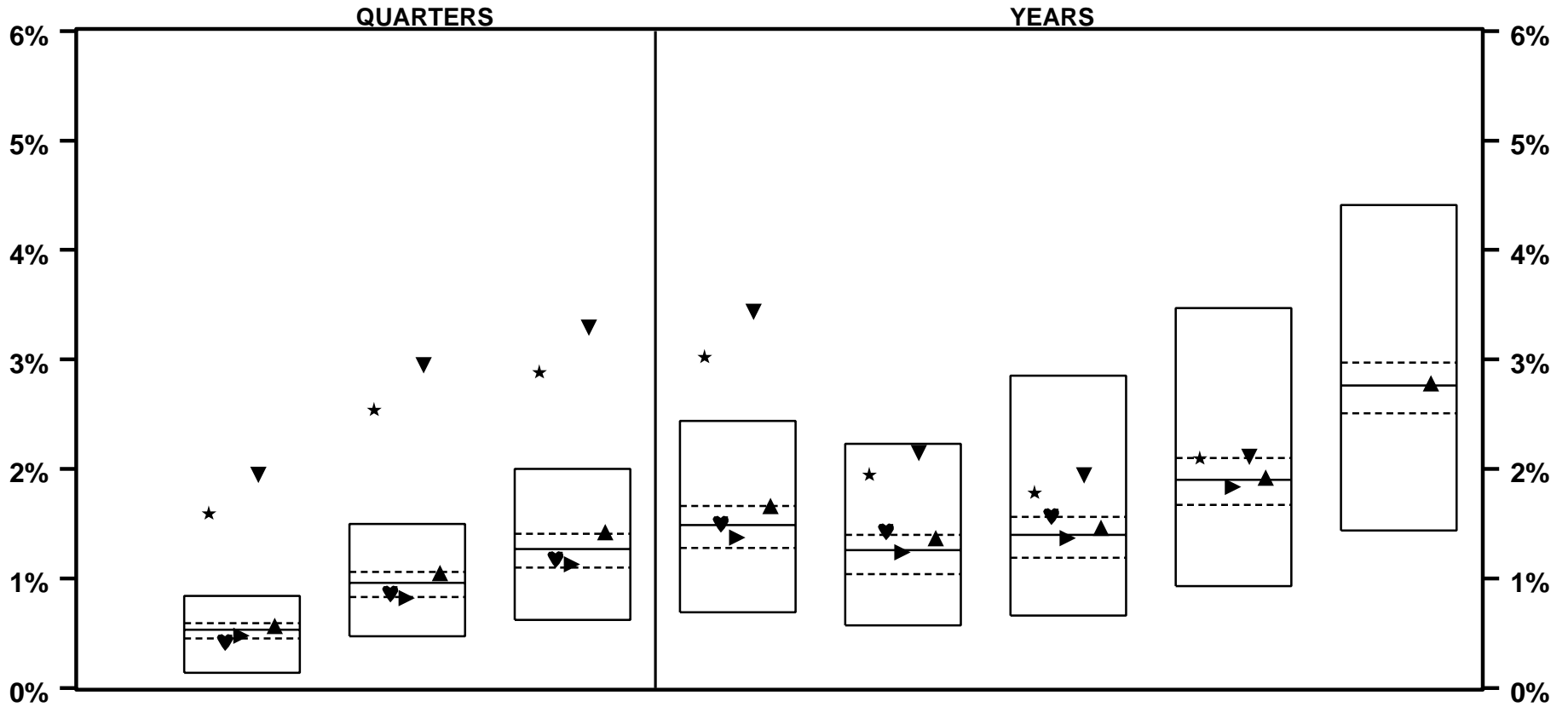

	LAST QTR		LAST 2 QTRS		LAST 3 QTRS		LAST YEAR		LAST 2 YEARS		LAST 3 YEARS		LAST 4 YEARS		LAST 5 YEARS	
★ MUNI COMPOSITE	1.6	1	2.5	1	2.9	2	3.0	3	2.0	6	1.8	13	2.1	25		
♥ UBS	0.4	79	0.9	69	1.2	64	1.5	48	1.4	21	1.6	23				
▶ ALT. ASSETS	0.5	67	0.8	75	1.1	70	1.4	63	1.2	51	1.4	53	1.8	59		
▼ VERMONT INVEST	2.0	1	3.0	1	3.3	2	3.4	2	2.1	5	1.9	10	2.1	23		
▲ 90 DAY T-BILLS	0.6	32	1.1	26	1.4	22	1.7	23	1.4	29	1.5	37	1.9	45	2.8	46
MEDIAN	0.5		1.0		1.3		1.5		1.3		1.4		1.9		2.8	

VERMONT MUNICIPAL EMPLOYEES

CASH EQUIVALENTS - RATES OF RETURN

YEARS ENDING

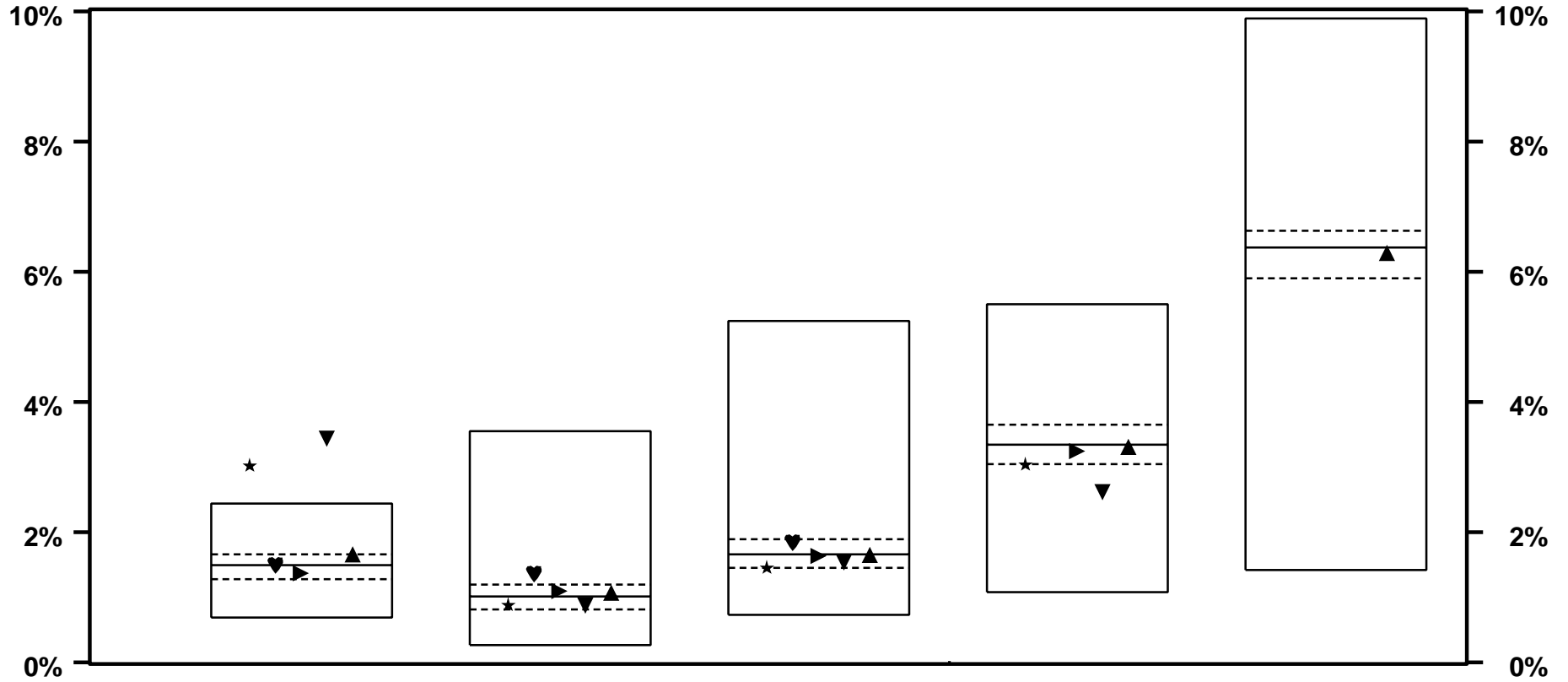

	3 / 05		3 / 04		3 / 03		3 / 02		3 / 01	
★ MUNI COMPOSITE	3.0	3	0.9	68	1.5	74	3.0	74		
♥ UBS	1.5	48	1.4	15	1.8	26				
▶ ALT. ASSETS	1.4	63	1.1	34	1.6	53	3.2	61		
▼ VERMONT INVEST	3.4	2	0.9	69	1.5	68	2.6	87		
▲ 90 DAY T-BILLS	1.7	23	1.1	38	1.7	50	3.3	53	6.3	55
MEDIAN	1.5		1.0		1.7		3.3		6.4	

VERMONT MUNICIPAL EMPLOYEES

INT'L DEVELOPED MKT EQUITY FUNDS - RATES OF RETURN

PERIODS ENDING 3/05

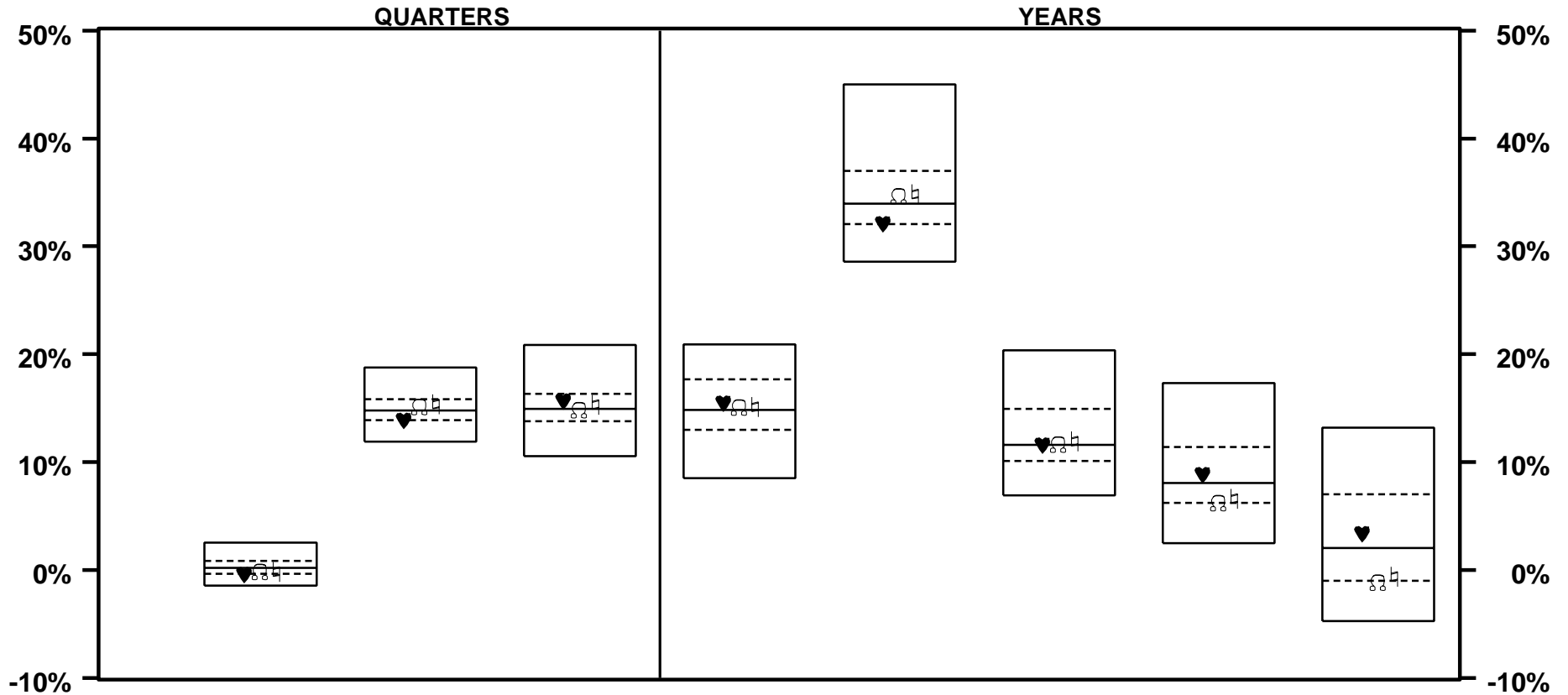

	LAST QTR		LAST 2 QTRS		LAST 3 QTRS		LAST YEAR		LAST 2 YEARS		LAST 3 YEARS		LAST 4 YEARS		LAST 5 YEARS	
♥ UBS	-0.4	76	13.9	75	15.7	36	15.5	41	32.1	74	11.6	50	8.9	44	3.4	43
Ω MS EAFE NET	-0.2	68	15.1	41	14.8	57	15.1	47	34.6	42	11.6	46	6.2	74	-1.1	77
□ CITI PMI EPAC	-0.1	67	15.4	34	15.3	40	15.2	47	34.8	41	11.9	45	6.6	70	-0.6	71
MEDIAN	0.2		14.8		14.9		14.8		33.9		11.6		8.1		2.0	

VERMONT MUNICIPAL EMPLOYEES

INT'L DEVELOPED MKT EQUITY FUNDS - RATES OF RETURN

PERIODS ENDING 3/05

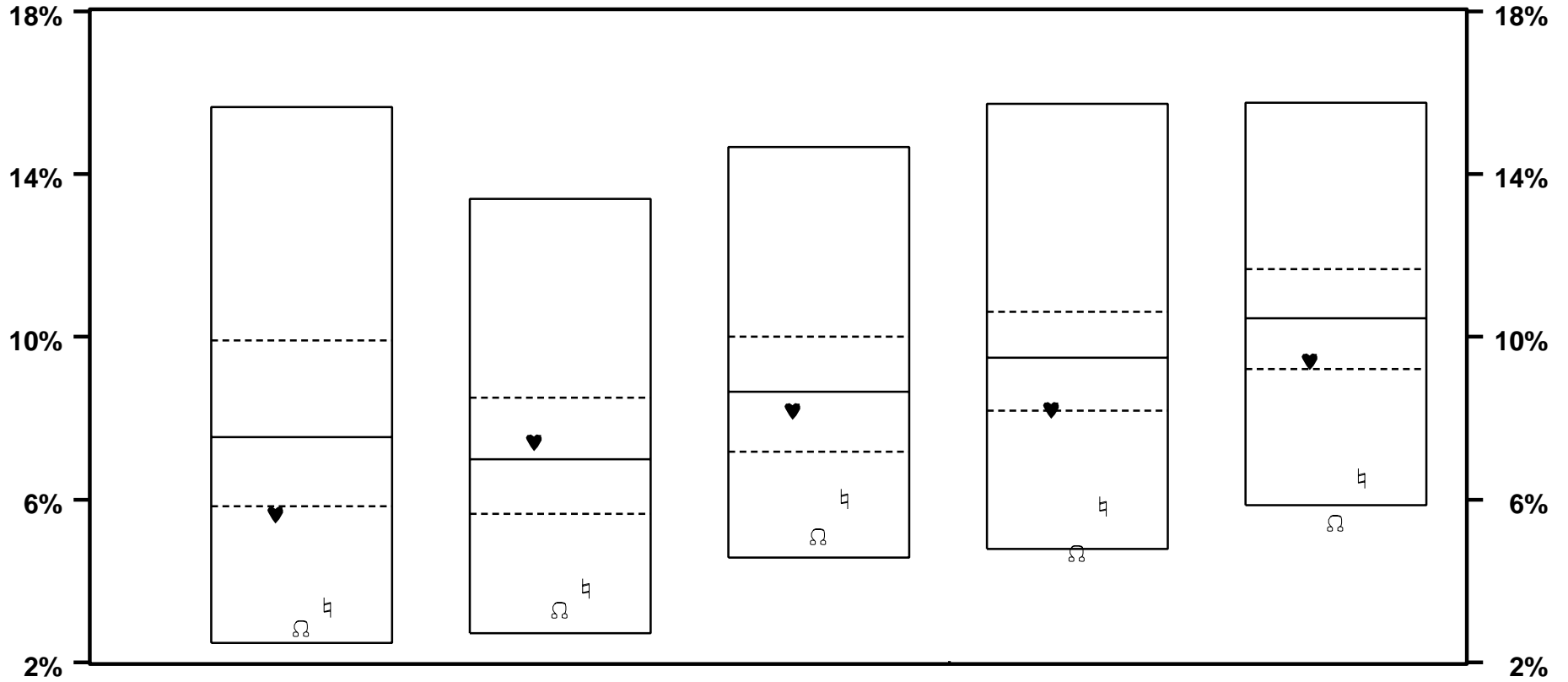

	LAST 6 YEARS		LAST 7 YEARS		LAST 8 YEARS		LAST 9 YEARS		LAST 10 YEARS	
♥ UBS	5.6	77	7.4	38	8.2	59	8.2	74	9.4	71
Ω MS EAFE NET	2.8	94	3.3	93	5.1	93	4.7	95	5.4	100
□ CITI PMI EPAC	3.4	90	3.8	87	6.0	82	5.8	89	6.5	88
MEDIAN	7.5		7.0		8.7		9.5		10.5	

VERMONT MUNICIPAL EMPLOYEES

INT'L DEVELOPED MKT EQUITY FUNDS - RATES OF RETURN

YEARS ENDING

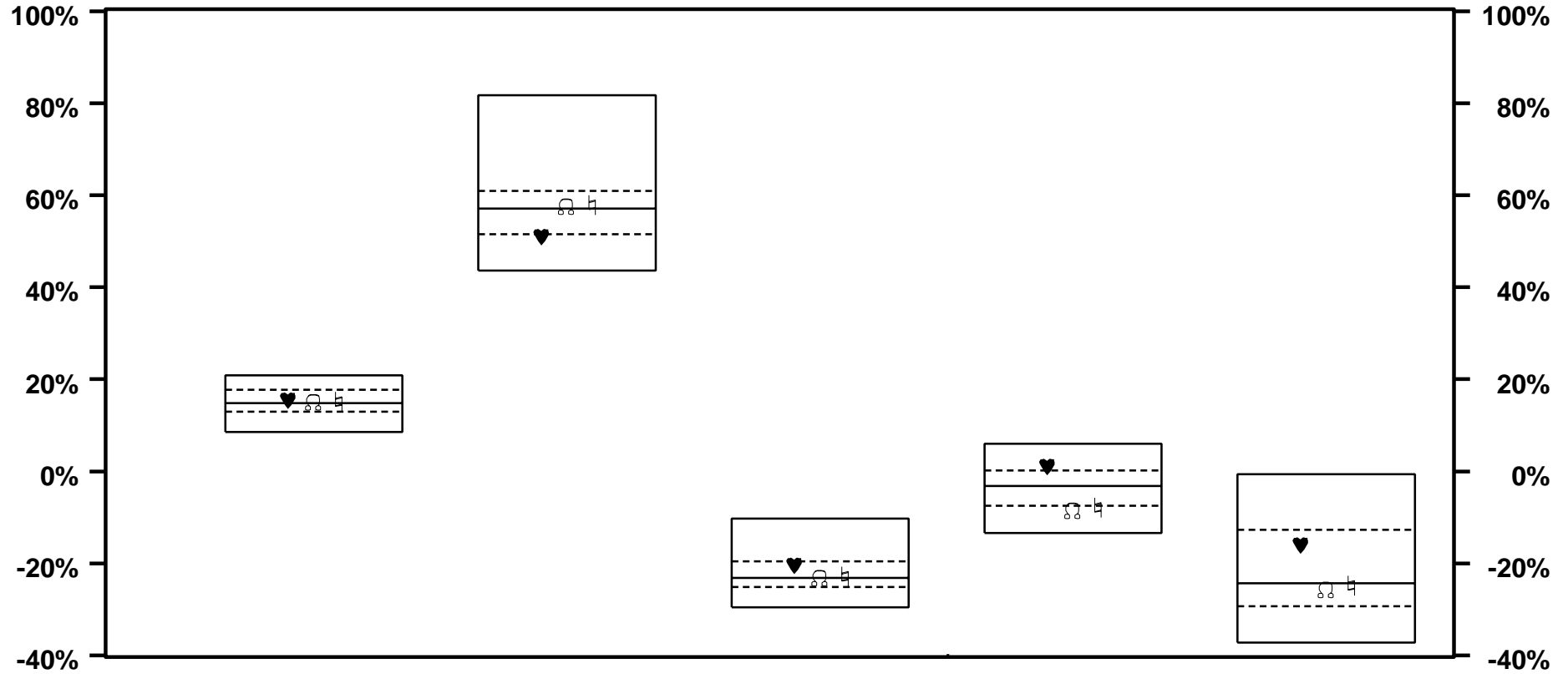

	3 / 05		3 / 04		3 / 03		3 / 02		3 / 01	
♥ UBS	15.5	41	51.1	77	-20.4	28	1.0	19	-16.0	32
Ω MS EAFE NET	15.1	47	57.5	45	-23.2	51	-8.5	79	-25.8	57
⌋ CITI PMI EPAC	15.2	47	57.9	41	-22.9	47	-7.9	77	-24.8	51
MEDIAN	14.8		57.1		-23.2		-3.2		-24.4	

VERMONT MUNICIPAL EMPLOYEES

INT'L DEVELOPED MKT EQUITY FUNDS - RATES OF RETURN

YEARS ENDING

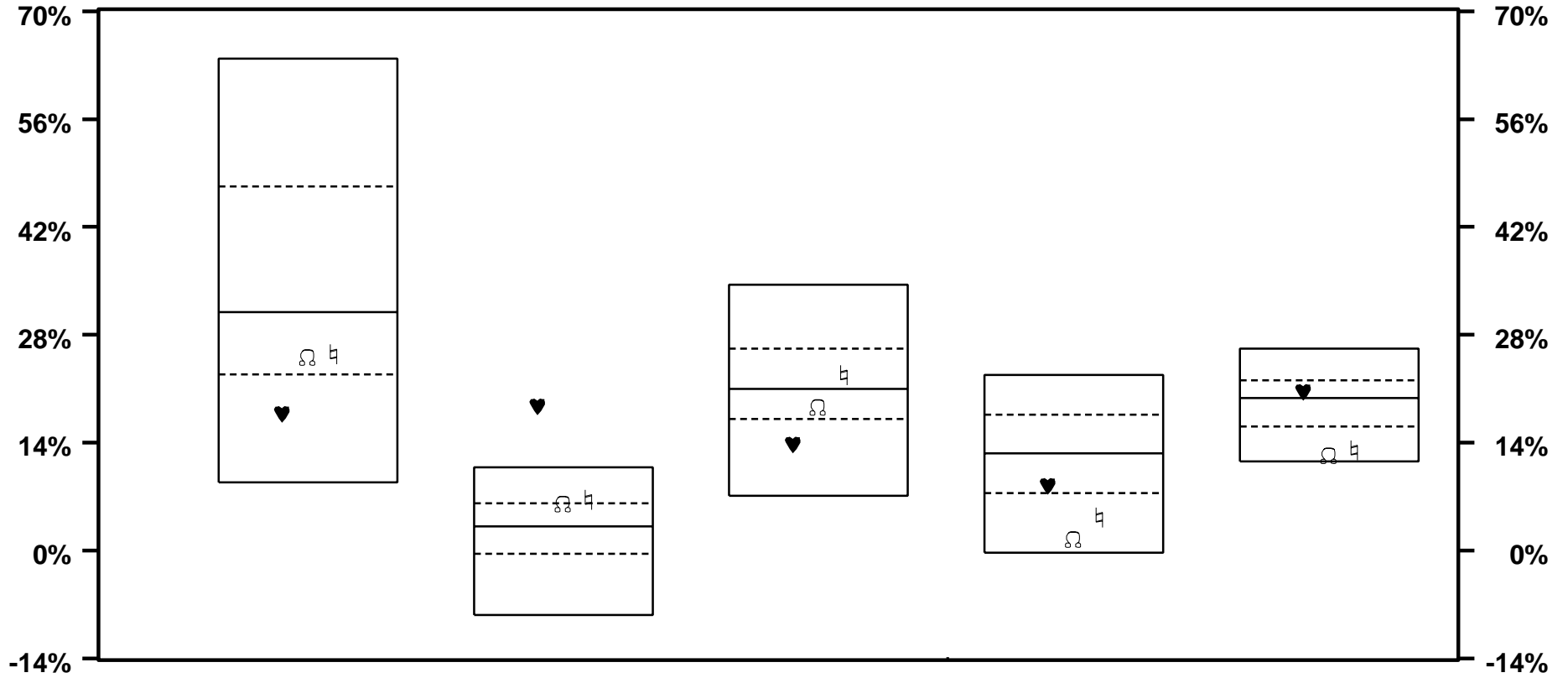

	3 / 00		3 / 99		3 / 98		3 / 97		3 / 96	
♥ UBS	17.7	84	18.7	1	13.8	87	8.4	71	20.6	37
Ω MS EAFE NET	25.1	64	6.1	25	18.6	62	1.5	92	12.3	93
□ CITI PMI EPAC	25.5	62	6.6	20	22.8	42	4.3	86	13.0	90
MEDIAN	30.9		3.1		21.0		12.6		19.8	

VERMONT MUNICIPAL EMPLOYEES
INT'L DEVELOPED MKT EQUITY FUNDS - TOTAL RETURN VS RISK
3 YEARS ENDING 3/05

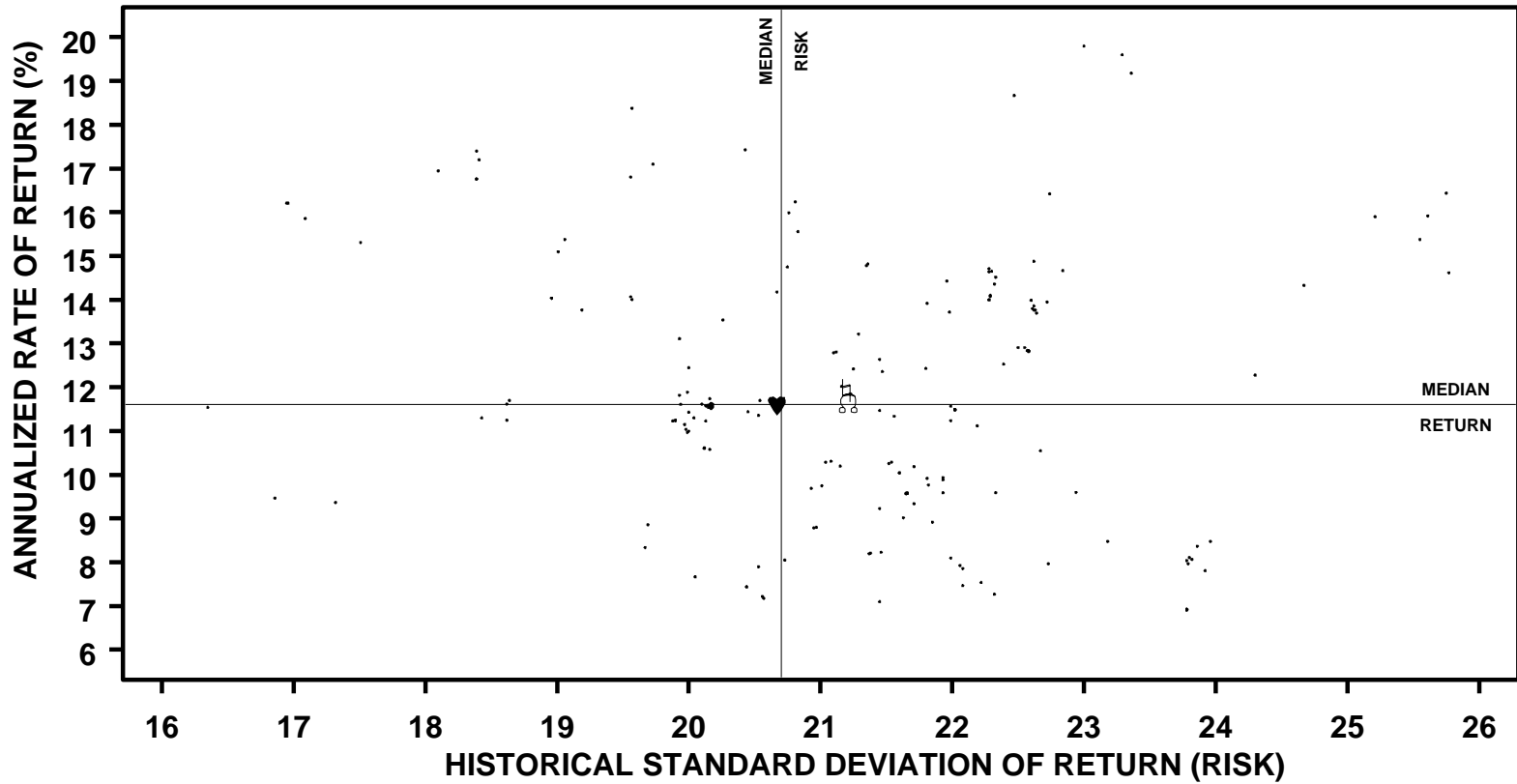

	ANNUALIZED RETURN		STANDARD DEVIATION		SHARPE RATIO	
	VALUE	RANK	VALUE	RANK	VALUE	RANK
♥ UBS	11.6	50	20.7	49	0.6	57
Ω MS EAFE NET	11.6	46	21.2	41	0.6	62
⚡ CITI PMI EPAC	11.9	45	21.2	41	0.6	53
MEDIAN	11.6		20.7		0.6	

VERMONT MUNICIPAL EMPLOYEES

INT'L DEVELOPED MKT EQUITY FUNDS - TOTAL RETURN VS RISK

5 YEARS ENDING 3/05

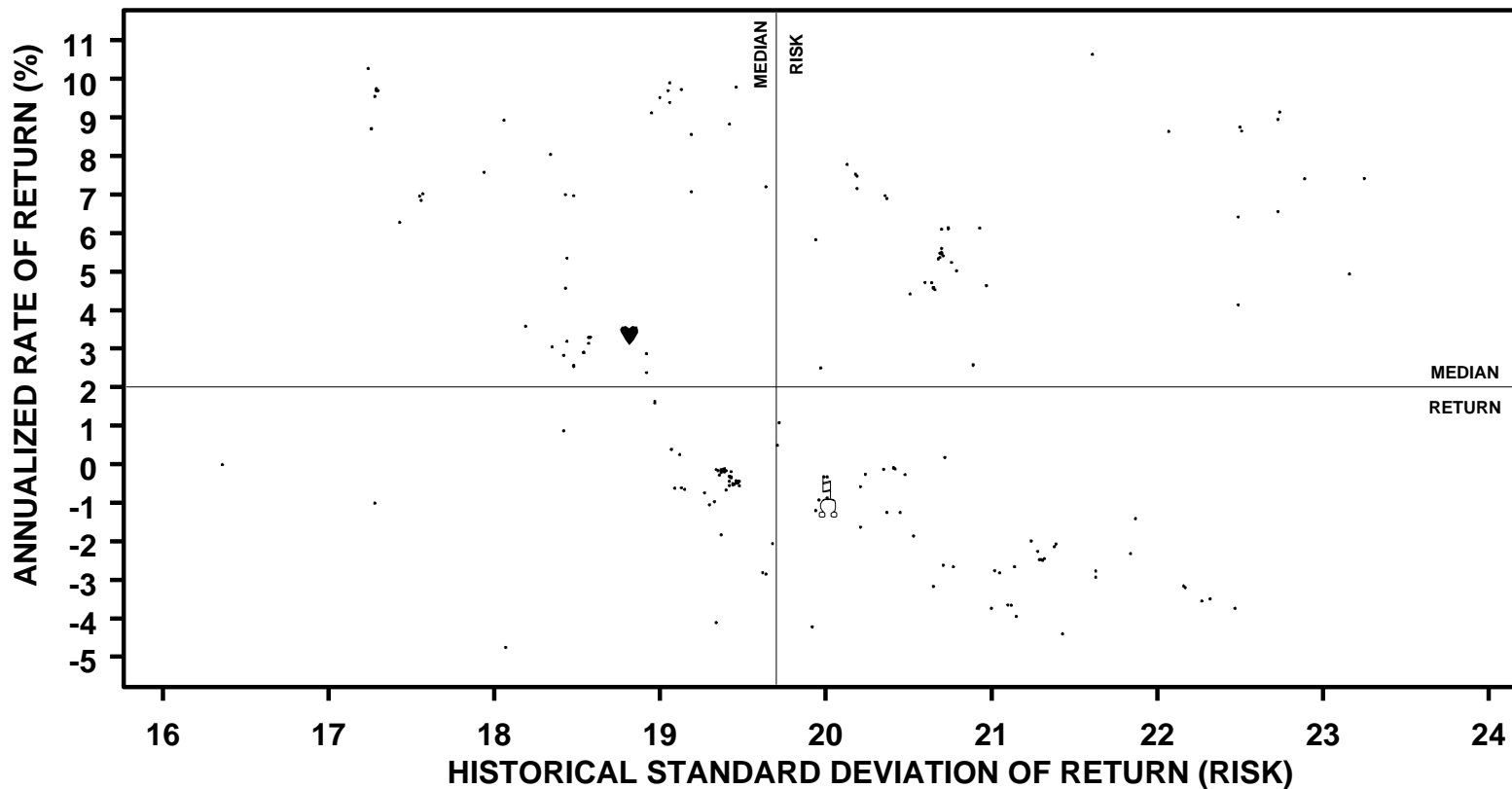

	ANNUALIZED RETURN		STANDARD DEVIATION		SHARPE RATIO	
	VALUE	RANK	VALUE	RANK	VALUE	RANK
♥ UBS	3.4	43	18.8	75	0.1	43
Ω MS EAFE NET	-1.1	77	20.0	44	-0.1	
□ CITI PMI EPAC	-0.6	71	20.0	45	-0.1	
MEDIAN	2.0		19.7		0.1	

VERMONT MUNICIPAL EMPLOYEES

INTERNATIONAL EQUITY ONLY - RATES OF RETURN

PERIODS ENDING 3/05

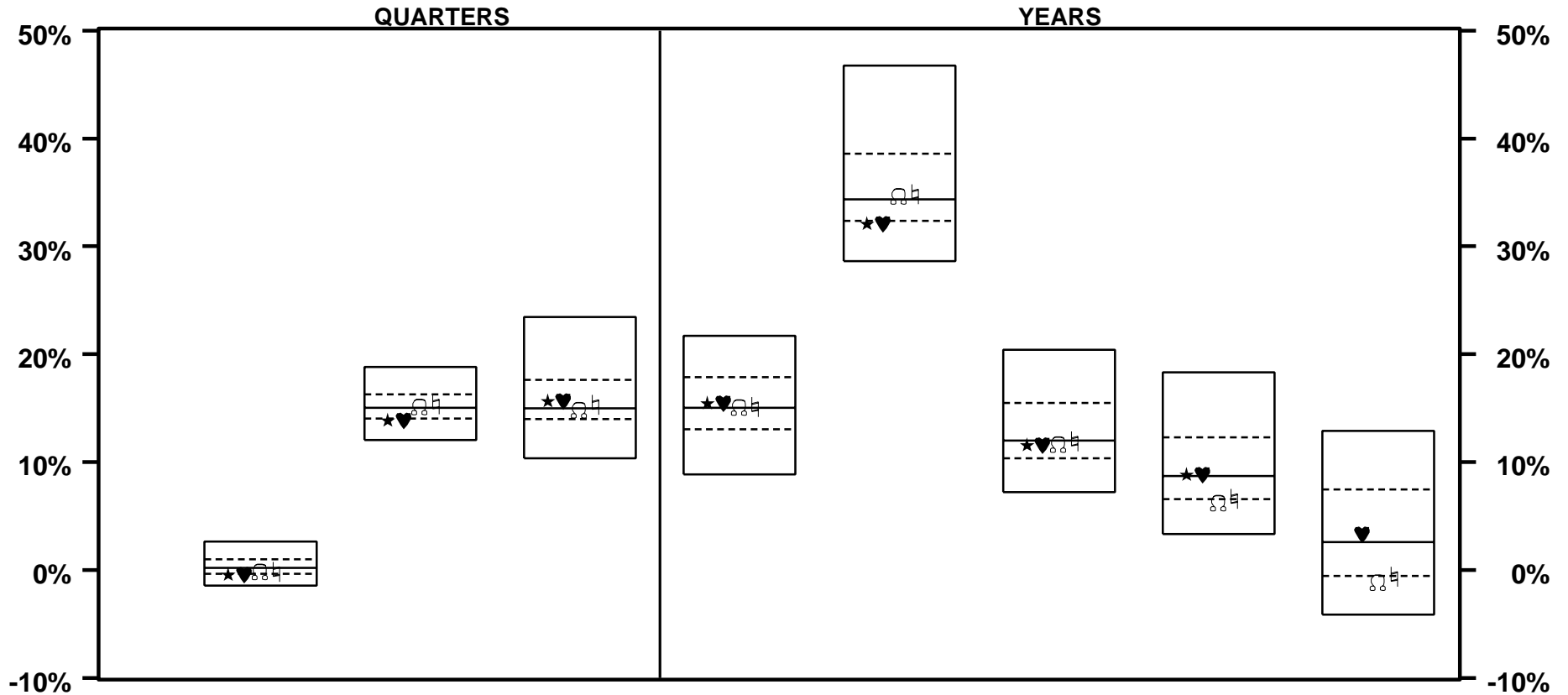

	LAST QTR		LAST 2 QTRS		LAST 3 QTRS		LAST YEAR		LAST 2 YEARS		LAST 3 YEARS		LAST 4 YEARS		LAST 5 YEARS	
★ MUNI COMPOSITE	-0.4	77	13.9	77	15.7	39	15.5	43	32.1	76	11.6	56	8.8	49		
♥ UBS	-0.4	77	13.9	77	15.7	39	15.5	43	32.1	76	11.6	56	8.8	49	3.4	44
Ω MS EAFE NET	-0.2	69	15.1	46	14.8	60	15.1	49	34.6	46	11.6	51	6.2	78	-1.1	80
⌘ CITI PMI EPAC	-0.1	68	15.4	39	15.3	44	15.2	49	34.8	45	11.9	50	6.6	74	-0.6	75
MEDIAN	0.2		15.0		15.0		15.0		34.4		12.0		8.7		2.6	

VERMONT MUNICIPAL EMPLOYEES

INTERNATIONAL EQUITY ONLY - RATES OF RETURN

PERIODS ENDING 3/05

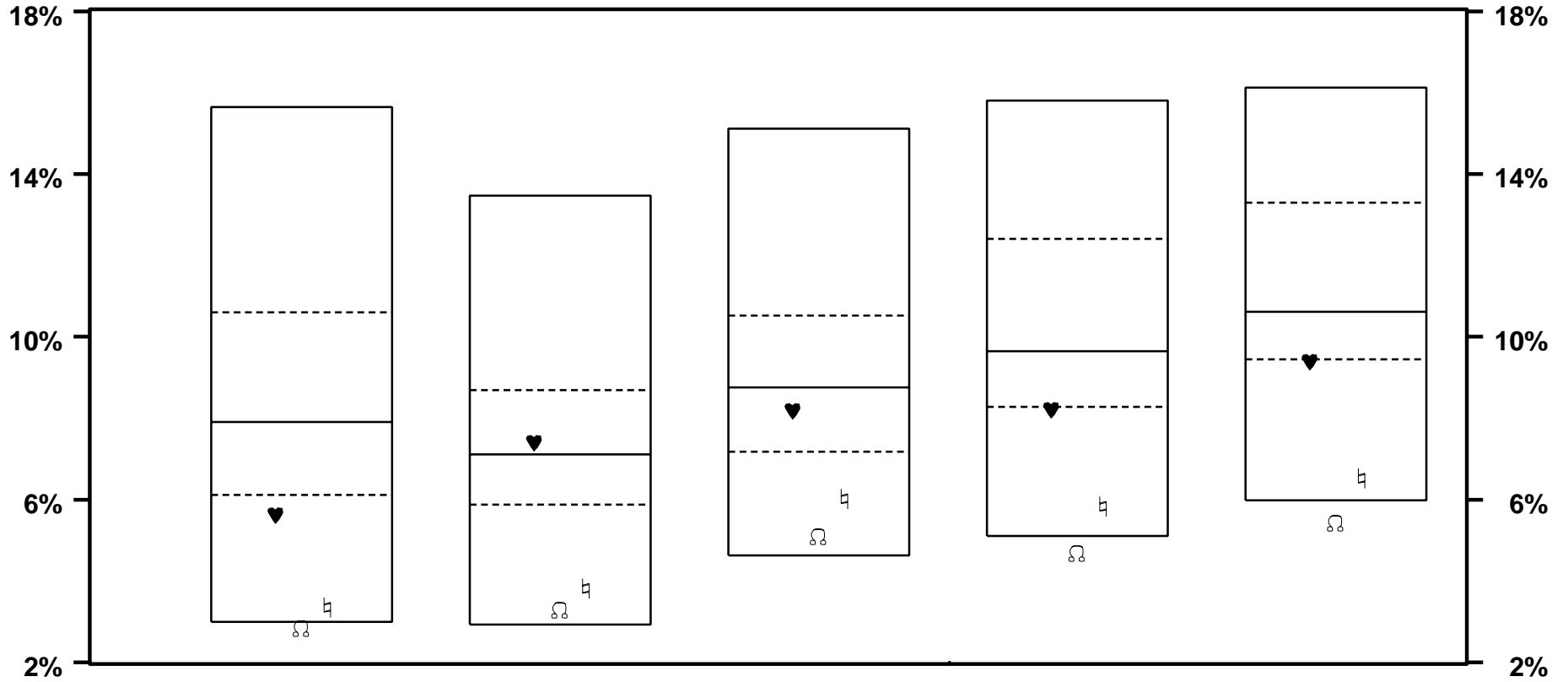

	LAST 6 YEARS		LAST 7 YEARS		LAST 8 YEARS		LAST 9 YEARS		LAST 10 YEARS	
♥ UBS	5.6	79	7.4	40	8.2	59	8.2	77	9.4	75
⊙ MS EAFE NET	2.8	95	3.3	93	5.1	92	4.7	97	5.4	99
⊠ CITI PMI EPAC	3.4	92	3.8	90	6.0	80	5.8	91	6.5	88
MEDIAN	7.9		7.1		8.8		9.6		10.6	

VERMONT MUNICIPAL EMPLOYEES

INTERNATIONAL EQUITY ONLY - RATES OF RETURN

YEARS ENDING

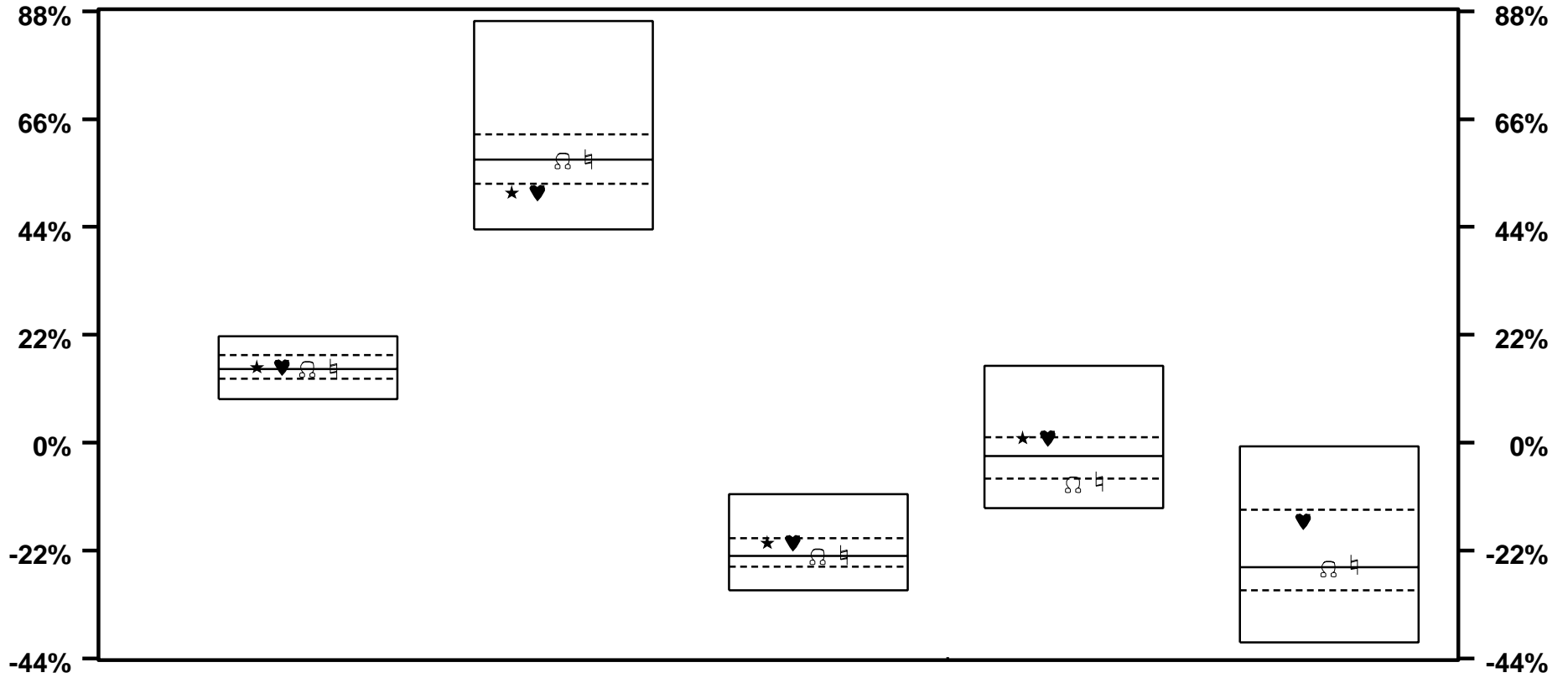

	3 / 05		3 / 04		3 / 03		3 / 02		3 / 01	
★ MUNI COMPOSITE	15.5	43	51.1	80	-20.4	28	1.0	26		
♥ UBS	15.5	43	51.1	80	-20.4	28	1.0	26	-16.0	29
Ω MS EAFE NET	15.1	49	57.5	51	-23.2	52	-8.5	79	-25.8	52
□ CITI PMI EPAC	15.2	49	57.9	48	-22.9	47	-7.9	78	-24.8	46
MEDIAN	15.0		57.8		-23.2		-2.7		-25.4	

VERMONT MUNICIPAL EMPLOYEES

INTERNATIONAL EQUITY ONLY - RATES OF RETURN

YEARS ENDING

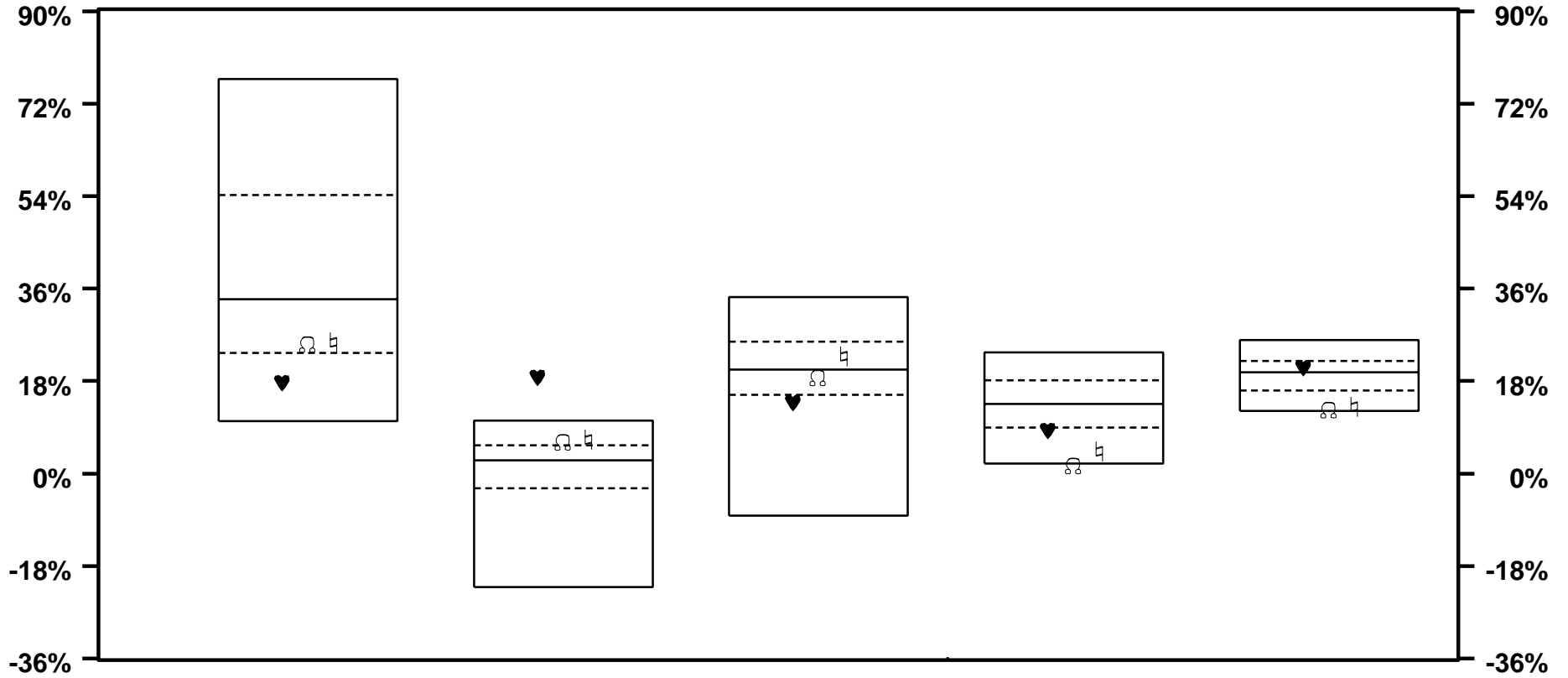

	3 / 00		3 / 99		3 / 98		3 / 97		3 / 96	
♥ UBS	17.7	86	18.7	1	13.8	79	8.4	75	20.6	36
○ MS EAFE NET	25.1	68	6.1	21	18.6	56	1.5	96	12.3	94
□ CITI PMI EPAC	25.5	66	6.6	18	22.8	39	4.3	91	13.0	91
MEDIAN	33.9		2.6		20.2		13.6		19.7	

VERMONT MUNICIPAL EMPLOYEES

PRIVATE INVESTMENT FUNDS - TOTAL RATES OF RETURN

PERIODS ENDING 3/05

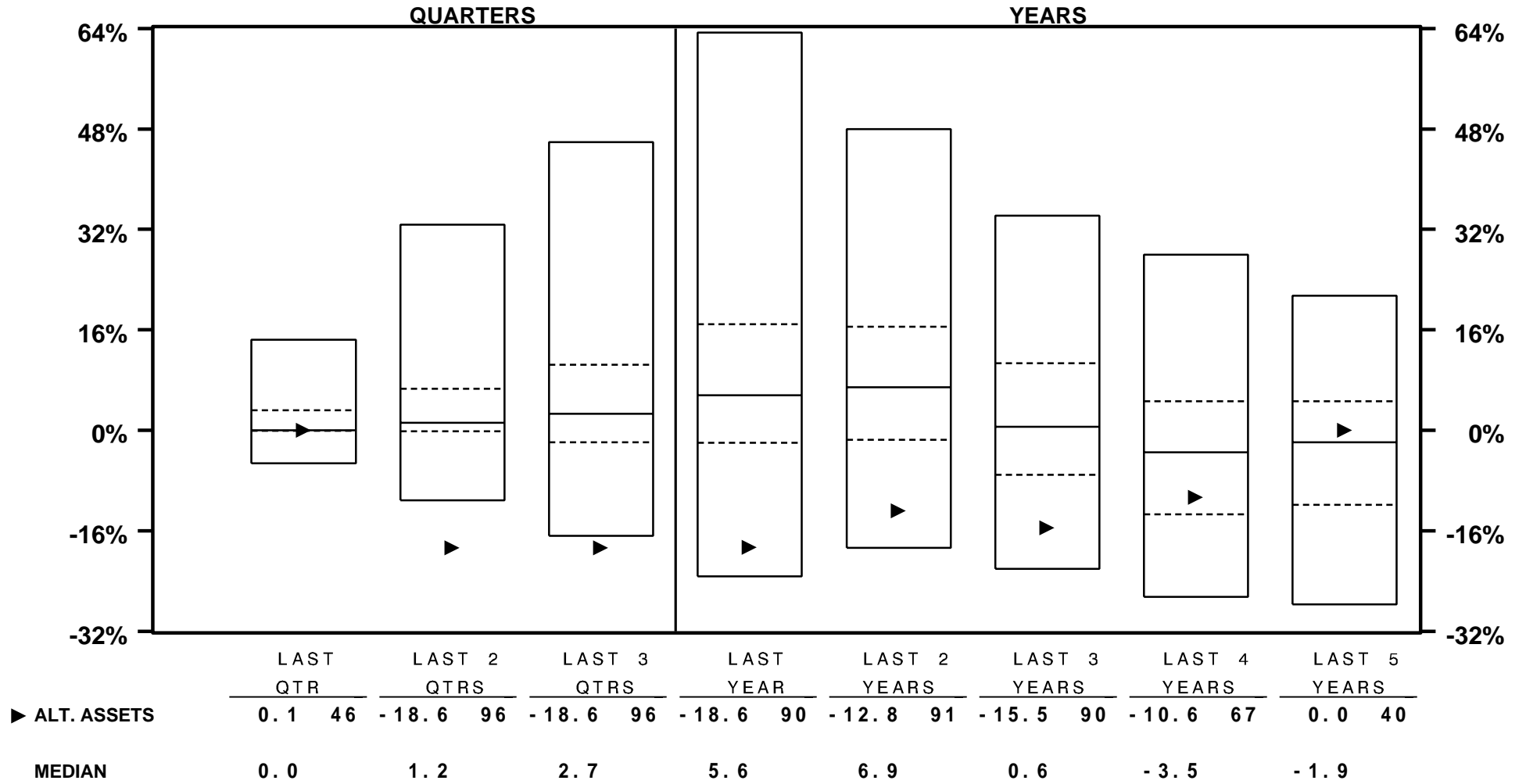

VERMONT MUNICIPAL EMPLOYEES

PRIVATE INVESTMENT FUNDS - TOTAL RATES OF RETURN

PERIODS ENDING 3/05

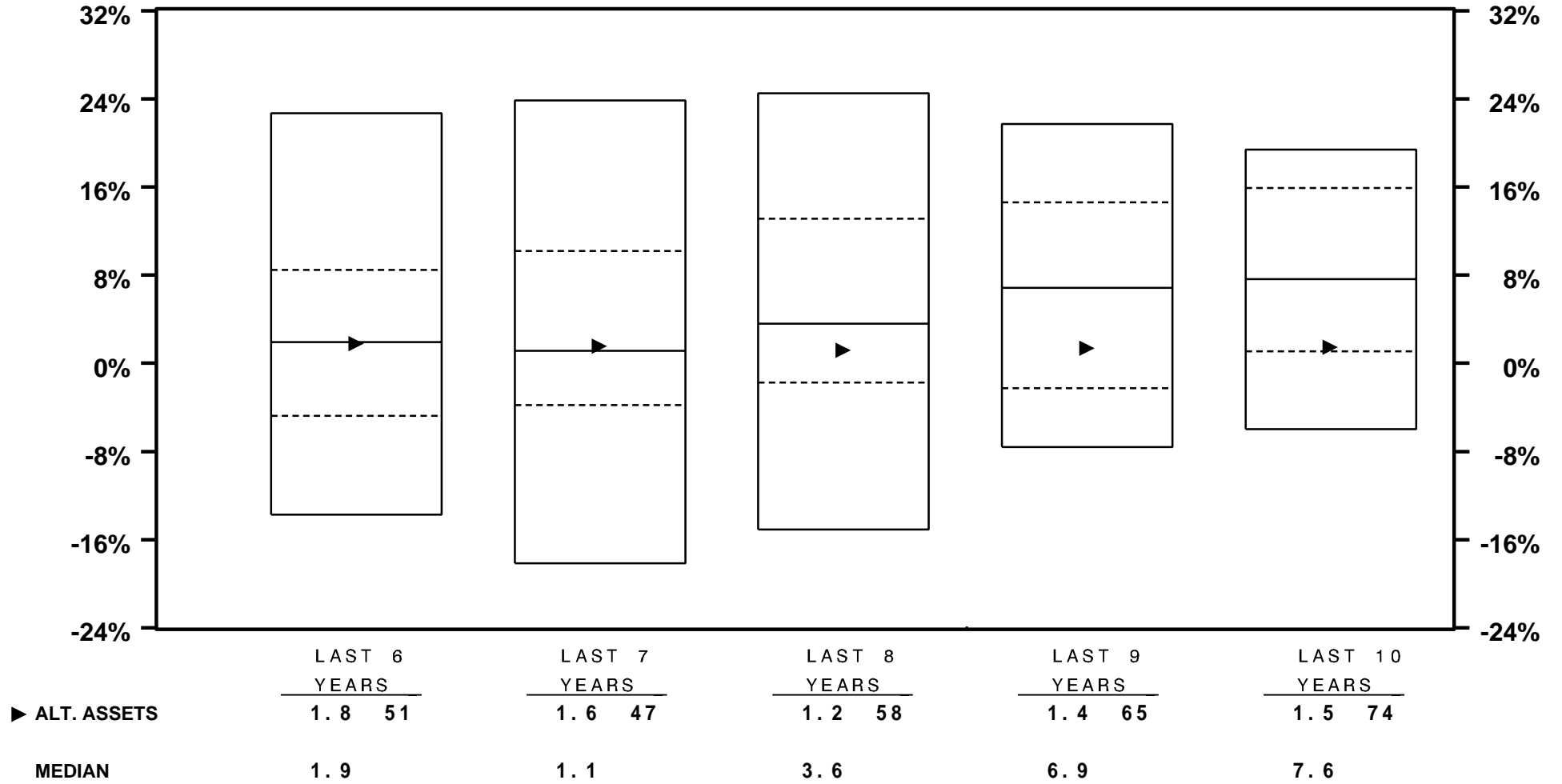

VERMONT MUNICIPAL EMPLOYEES

PRIVATE INVESTMENT FUNDS - TOTAL RATES OF RETURN

YEARS ENDING

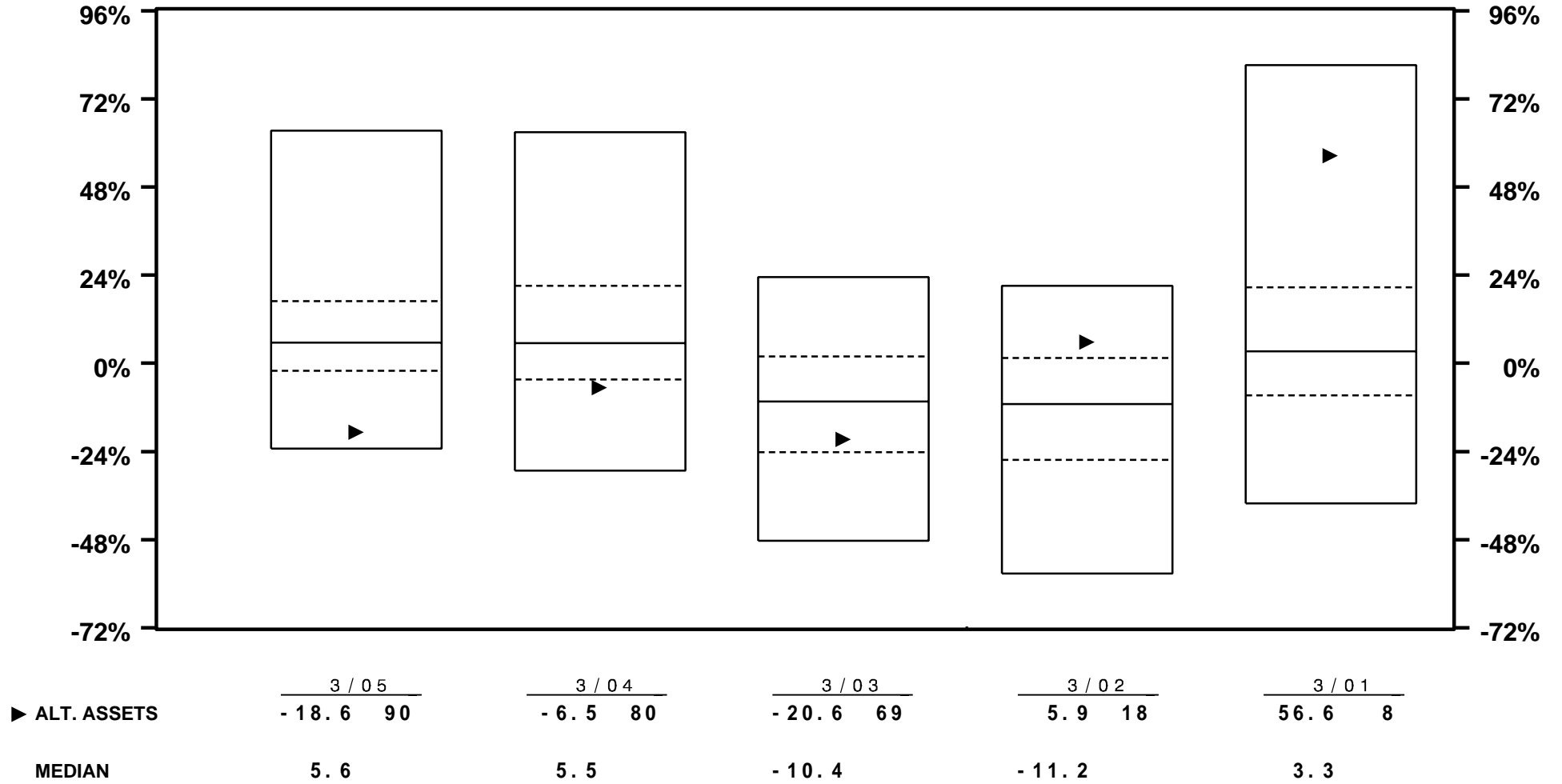

VERMONT MUNICIPAL EMPLOYEES

PRIVATE INVESTMENT FUNDS - TOTAL RATES OF RETURN

YEARS ENDING

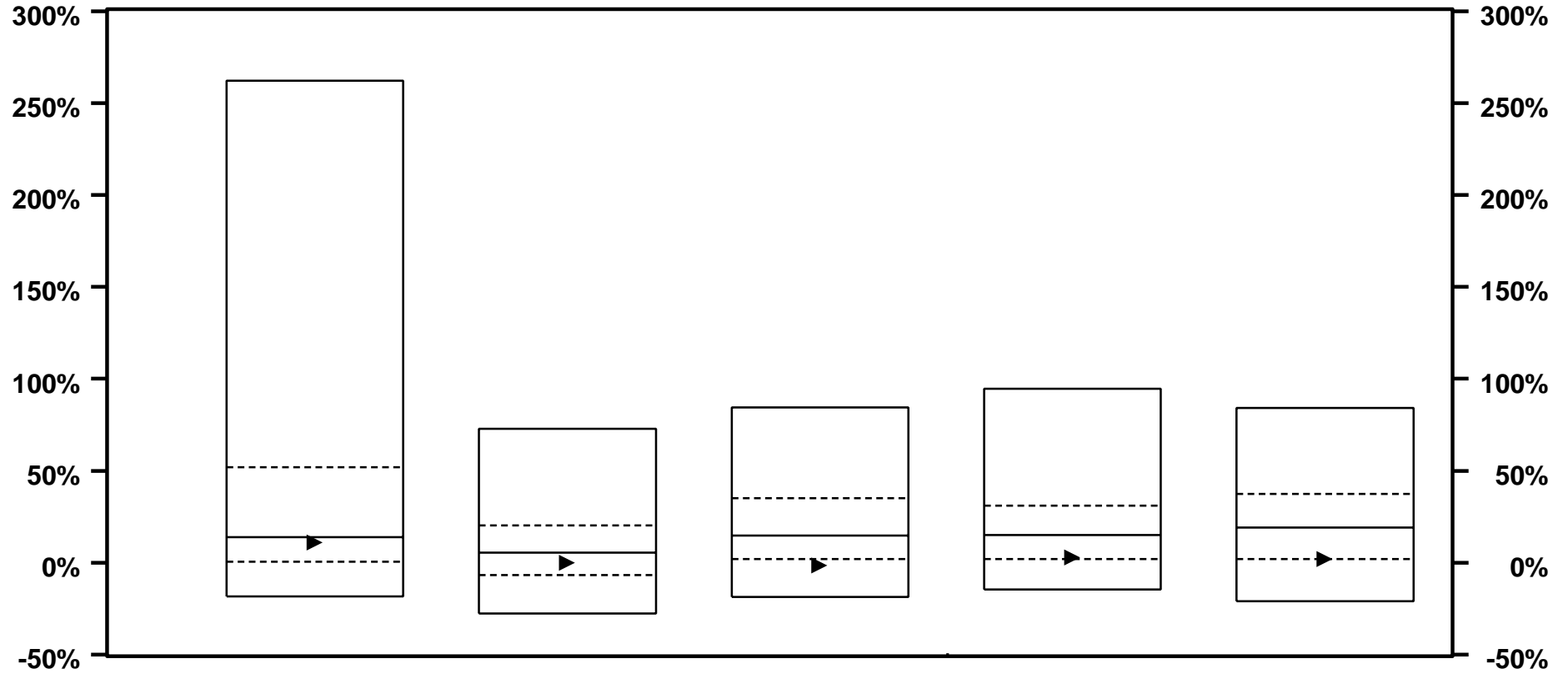

	3 / 00	3 / 99	3 / 98	3 / 97	3 / 96
▶ ALT. ASSETS	11.2 54	0.1 59	-1.3 84	3.1 70	2.1 73
MEDIAN	13.9	5.4	14.8	15.1	19.2

VERMONT MUNICIPAL EMPLOYEES

PRIVATE INVESTMENT FUNDS - TOTAL RETURN VS RISK

3 YEARS ENDING 3/05

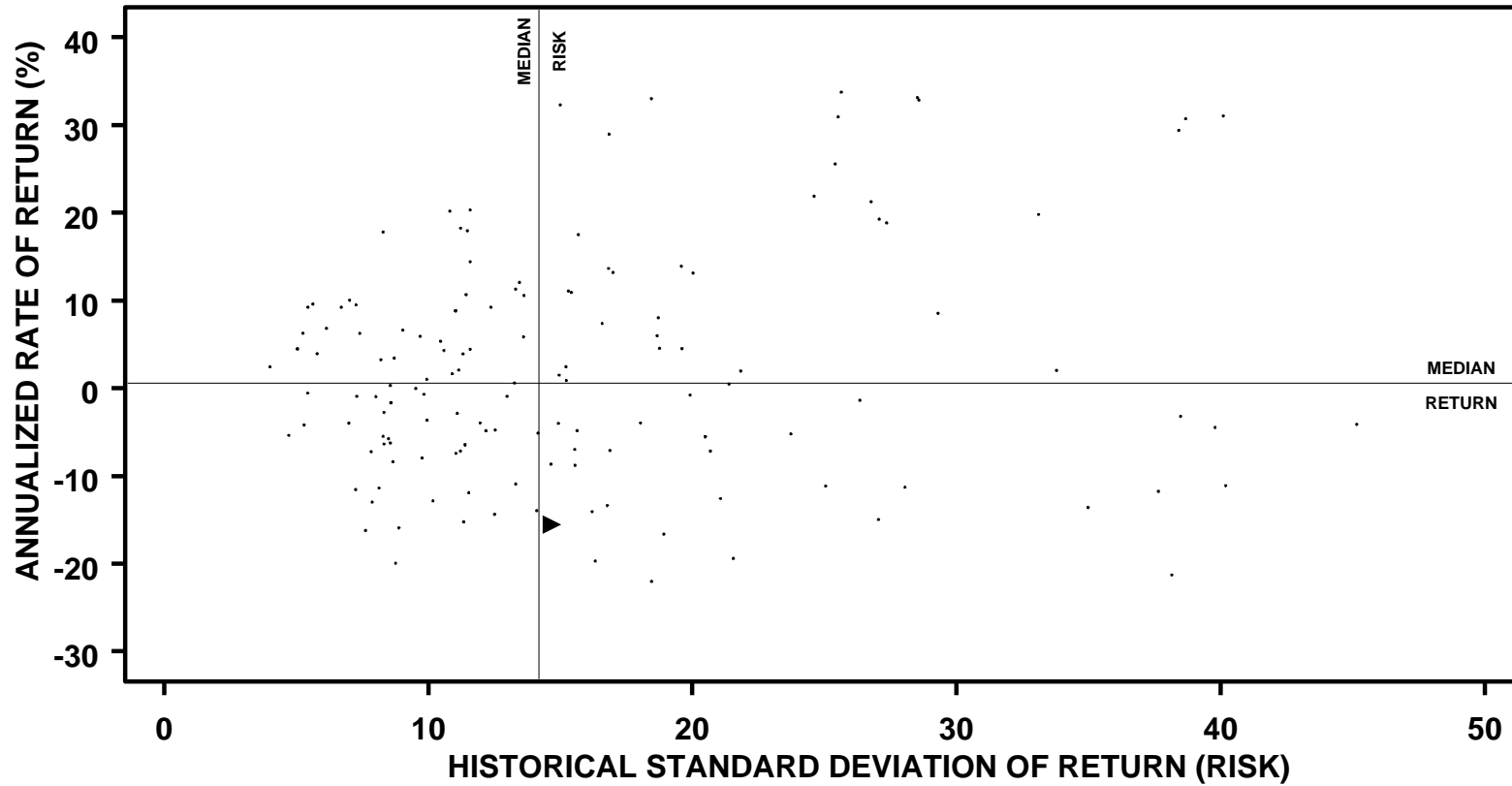

	ANNUALIZED RETURN		STANDARD DEVIATION		SHARPE RATIO	
	VALUE	RANK	VALUE	RANK	VALUE	RANK
▶ ALT. ASSETS	- 15.5	90	14.7	48	- 1.1	
MEDIAN	0.6		14.2		0.1	

VERMONT MUNICIPAL EMPLOYEES

PRIVATE INVESTMENT FUNDS - TOTAL RETURN VS RISK

5 YEARS ENDING 3/05

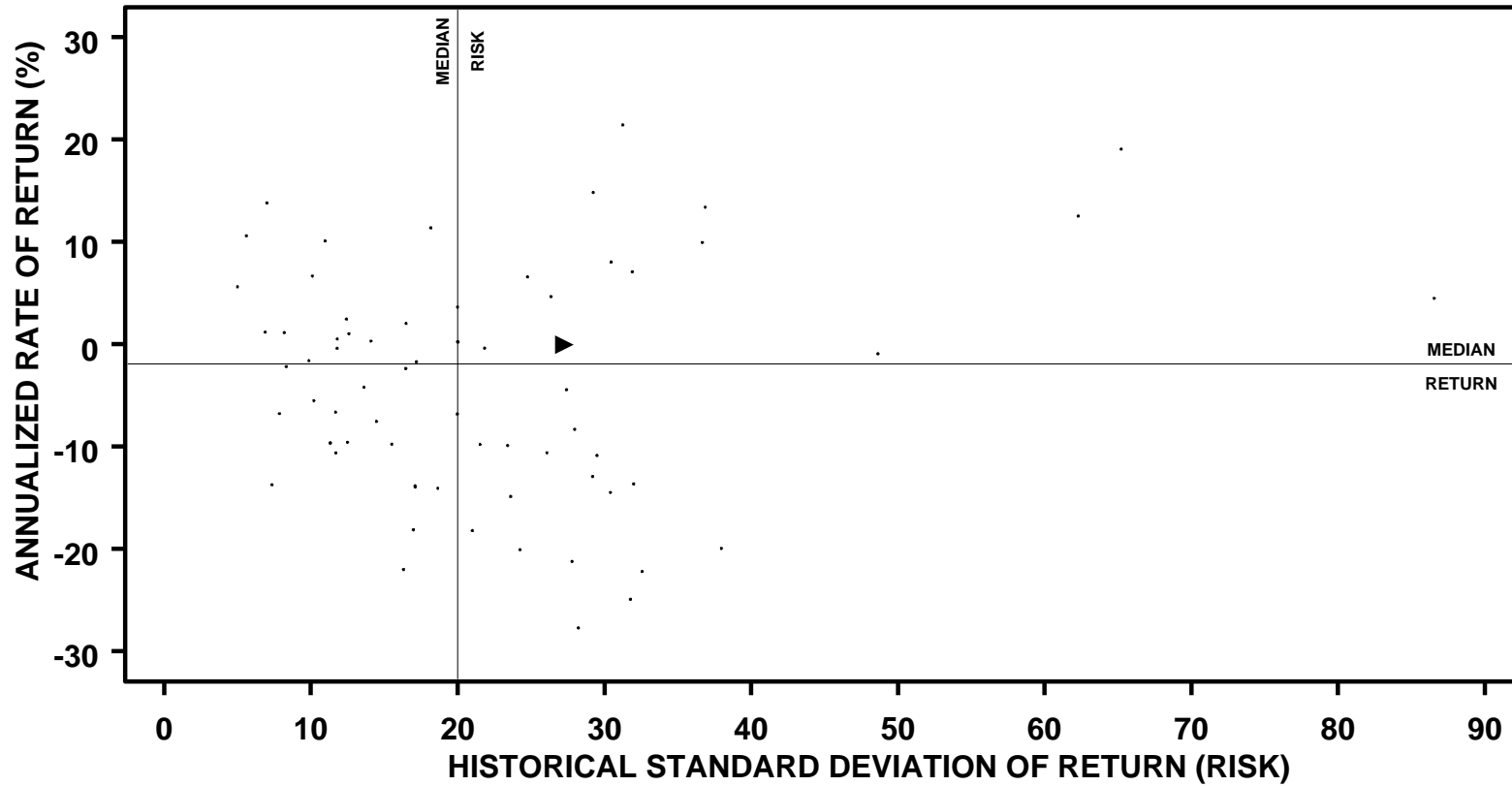

	ANNUALIZED RETURN		STANDARD DEVIATION		SHARPE RATIO	
	VALUE	RANK	VALUE	RANK	VALUE	RANK
▶ ALT. ASSETS	0.0	40	27.3	36	0.0	34
MEDIAN	-1.9		20.0		-0.2	

VERMONT MUNICIPAL EMPLOYEES

PRIVATE INVESTMENTS ONLY - TOTAL RATES OF RETURN

PERIODS ENDING 3/05

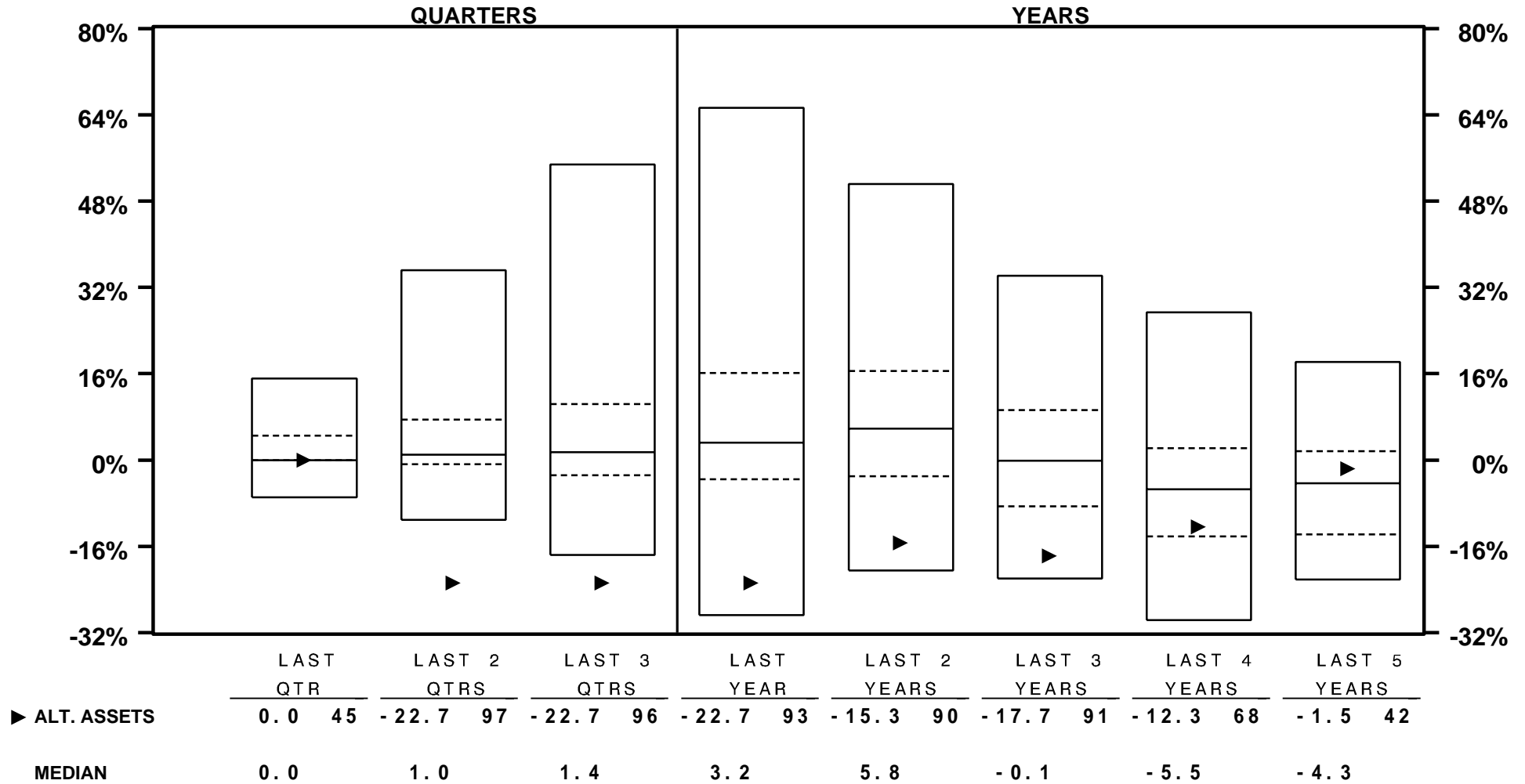

VERMONT MUNICIPAL EMPLOYEES

PRIVATE INVESTMENTS ONLY - TOTAL RATES OF RETURN

PERIODS ENDING 3/05

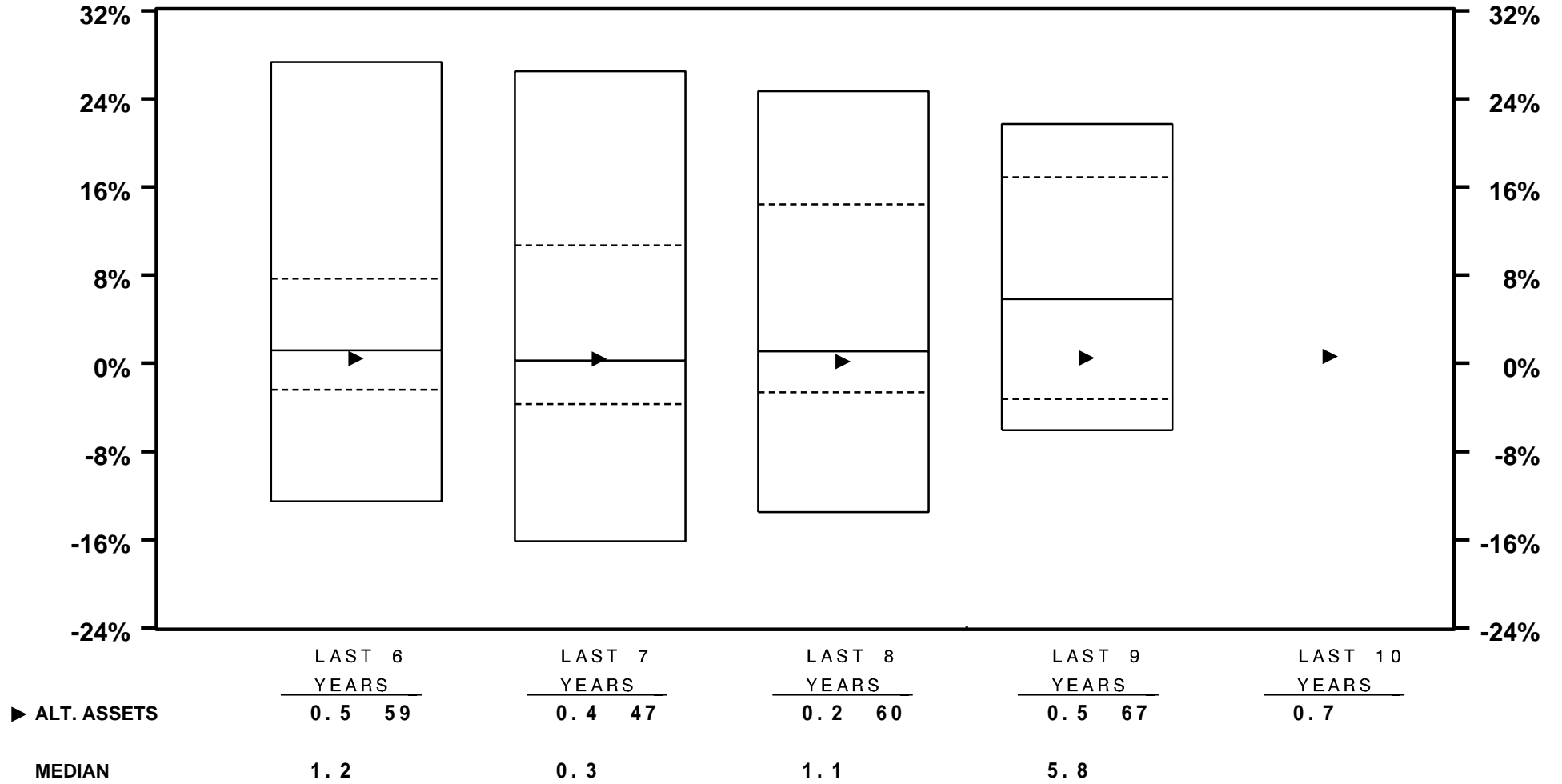

VERMONT MUNICIPAL EMPLOYEES

PRIVATE INVESTMENTS ONLY - TOTAL RATES OF RETURN

YEARS ENDING

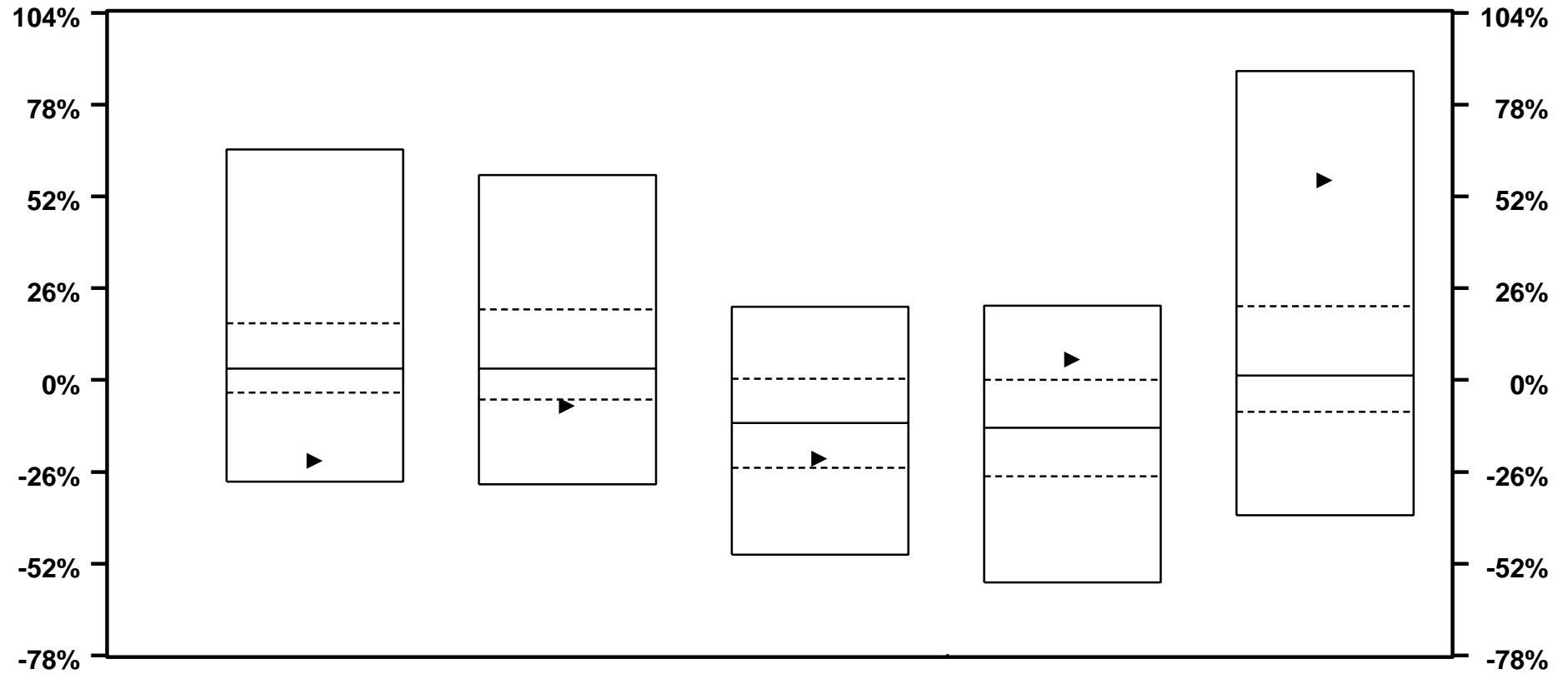

	<u>3 / 05</u>	<u>3 / 04</u>	<u>3 / 03</u>	<u>3 / 02</u>	<u>3 / 01</u>
▶ ALT. ASSETS	- 22.7 93	- 7.2 78	- 22.2 70	5.9 16	56.6 8
MEDIAN	3.2	3.3	- 12.2	- 13.5	1.2

VERMONT MUNICIPAL EMPLOYEES

PRIVATE INVESTMENTS ONLY - TOTAL RATES OF RETURN

YEARS ENDING

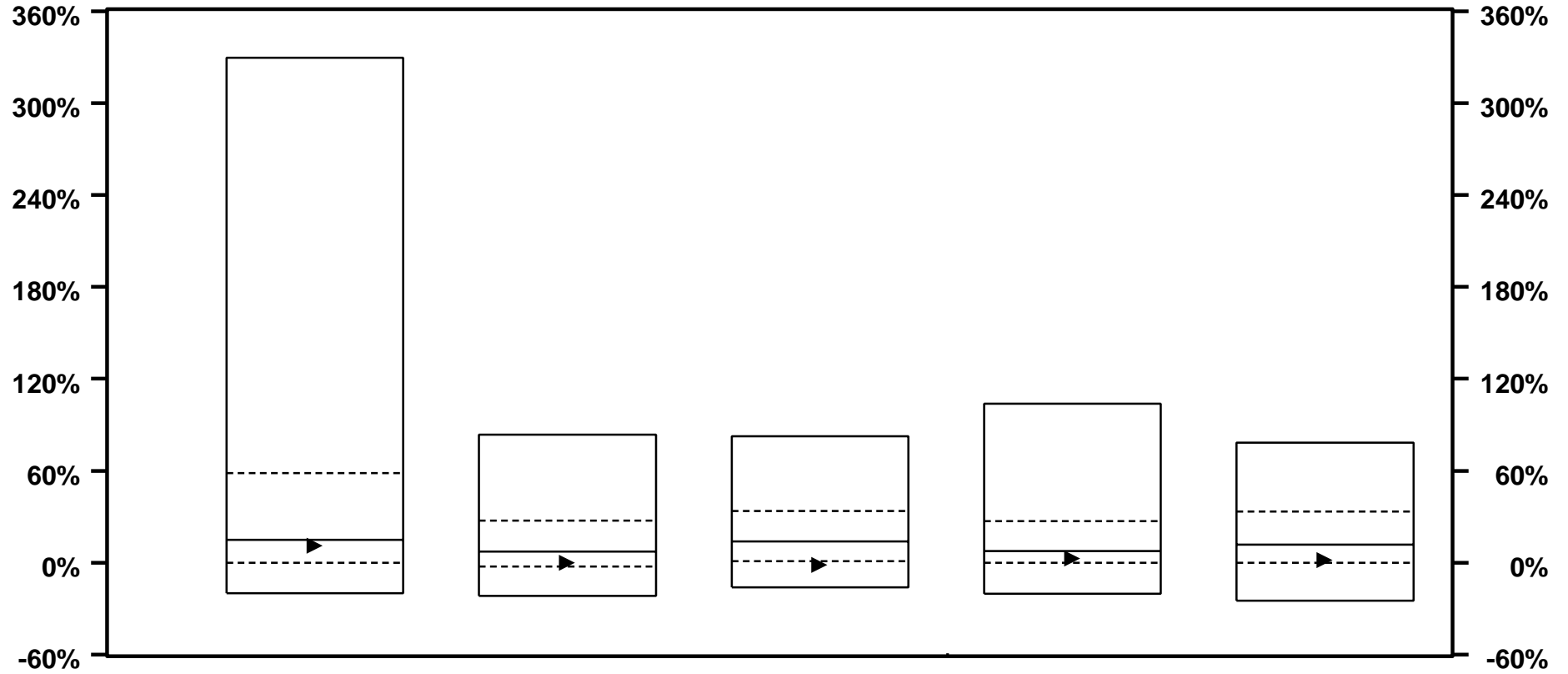

	<u>3 / 00</u>	<u>3 / 99</u>	<u>3 / 98</u>	<u>3 / 97</u>	<u>3 / 96</u>
▶ ALT. ASSETS	11.2 56	0.1 61	-1.3 84	3.1 63	2.1 67
MEDIAN	15.0	7.2	13.9	7.5	11.6

VERMONT MUNICIPAL EMPLOYEES

PRIVATE INVESTMENTS ONLY - TOTAL RETURN VS RISK

3 YEARS ENDING 3/05

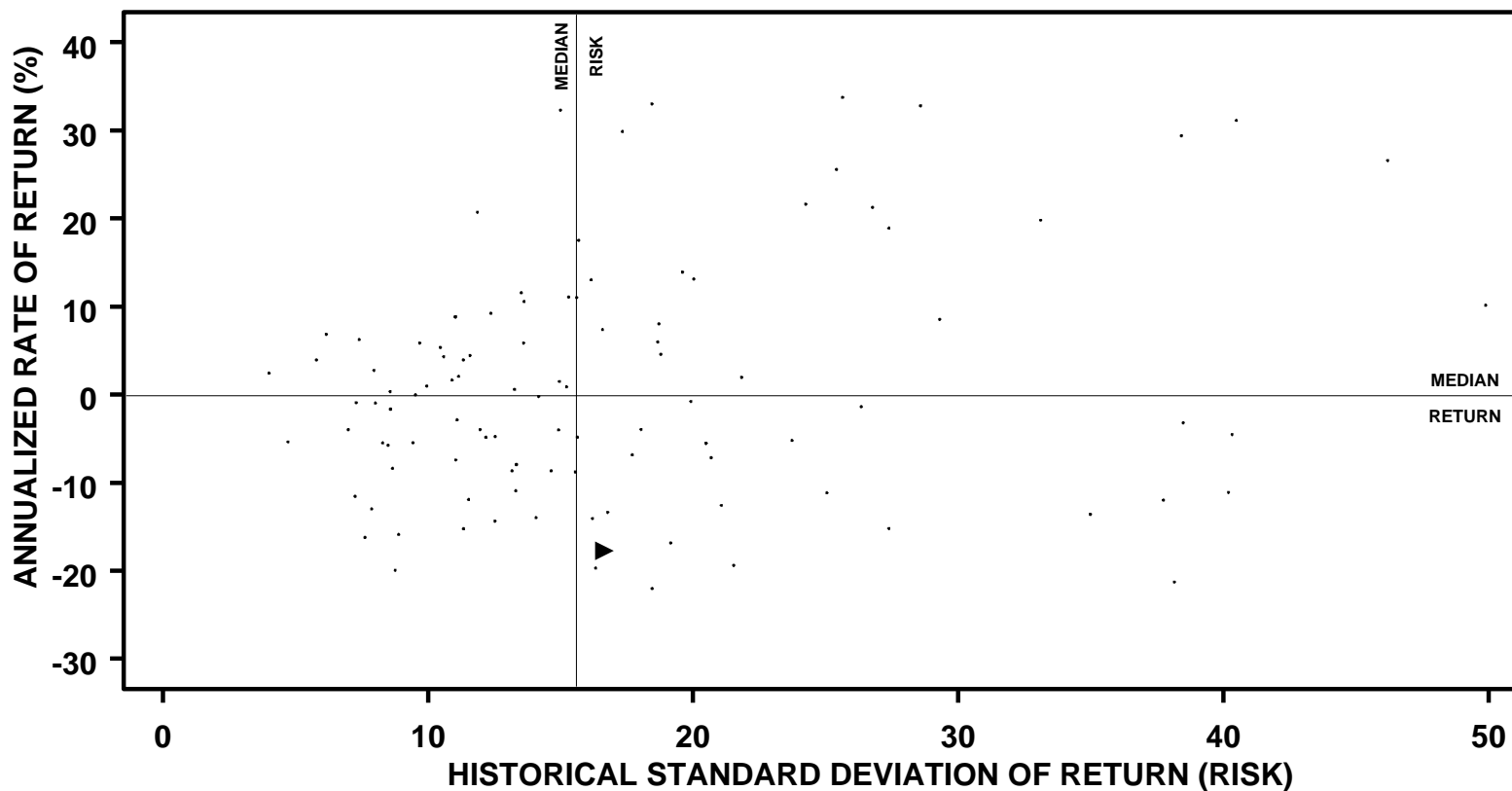

	ANNUALIZED RETURN		STANDARD DEVIATION		SHARPE RATIO	
	VALUE	RANK	VALUE	RANK	VALUE	RANK
▶ ALT. ASSETS	- 17.7	91	16.7	42	- 1.1	
MEDIAN	- 0.1		15.6		0.0	

VERMONT MUNICIPAL EMPLOYEES

PRIVATE INVESTMENTS ONLY - TOTAL RETURN VS RISK

5 YEARS ENDING 3/05

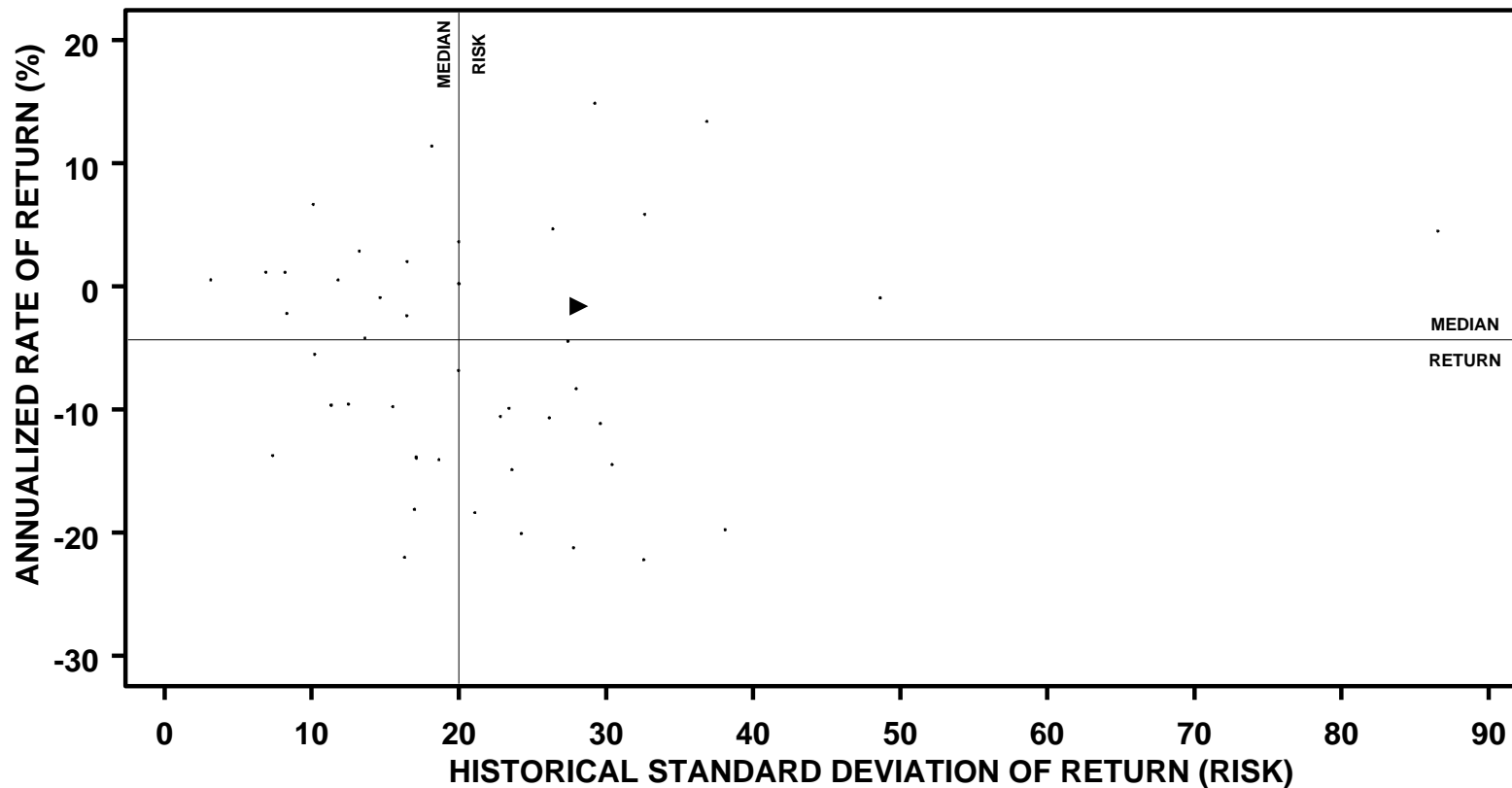

	ANNUALIZED RETURN		STANDARD DEVIATION		SHARPE RATIO	
	VALUE	RANK	VALUE	RANK	VALUE	RANK
▶ ALT. ASSETS	- 1 . 5	42	28 . 2	27	0 . 0	
MEDIAN	- 4 . 3		20 . 0		- 0 . 3	

VERMONT MUNICIPAL EMPLOYEES

PRIVATE EQUITY FUNDS - TOTAL RATES OF RETURN

PERIODS ENDING 3/05

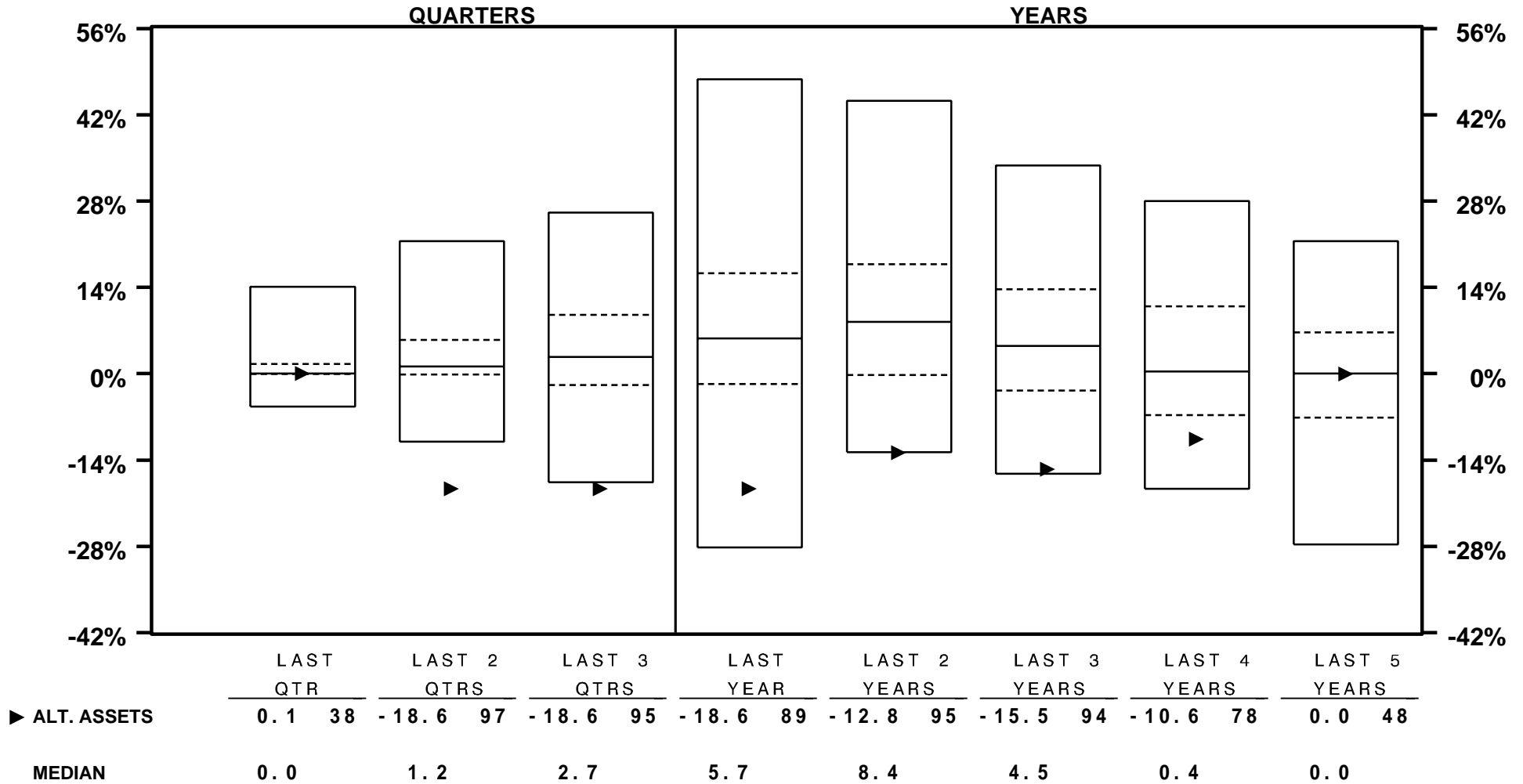

VERMONT MUNICIPAL EMPLOYEES

PRIVATE EQUITY FUNDS - TOTAL RATES OF RETURN

PERIODS ENDING 3/05

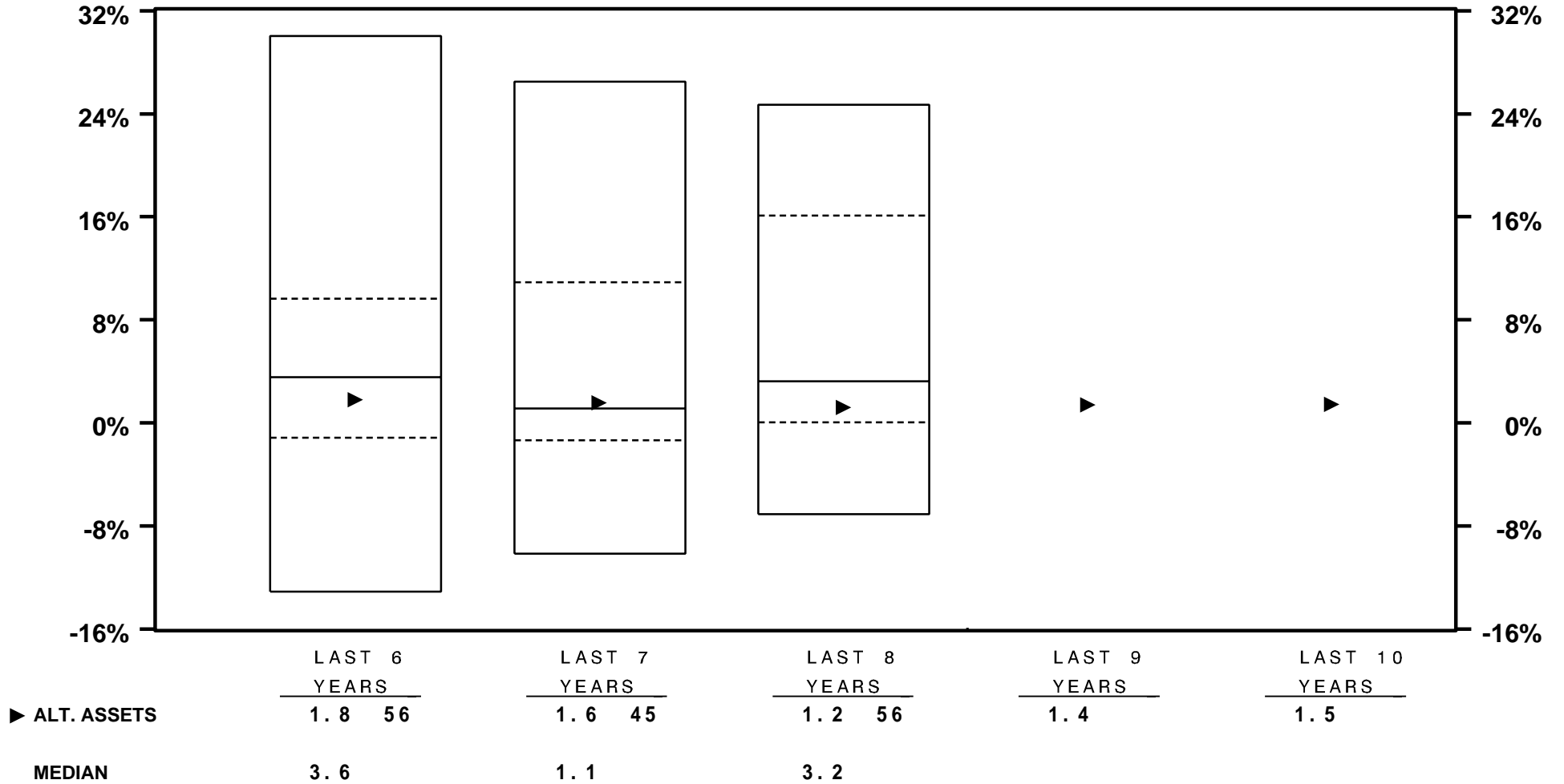

VERMONT MUNICIPAL EMPLOYEES

PRIVATE EQUITY FUNDS - TOTAL RATES OF RETURN

YEARS ENDING

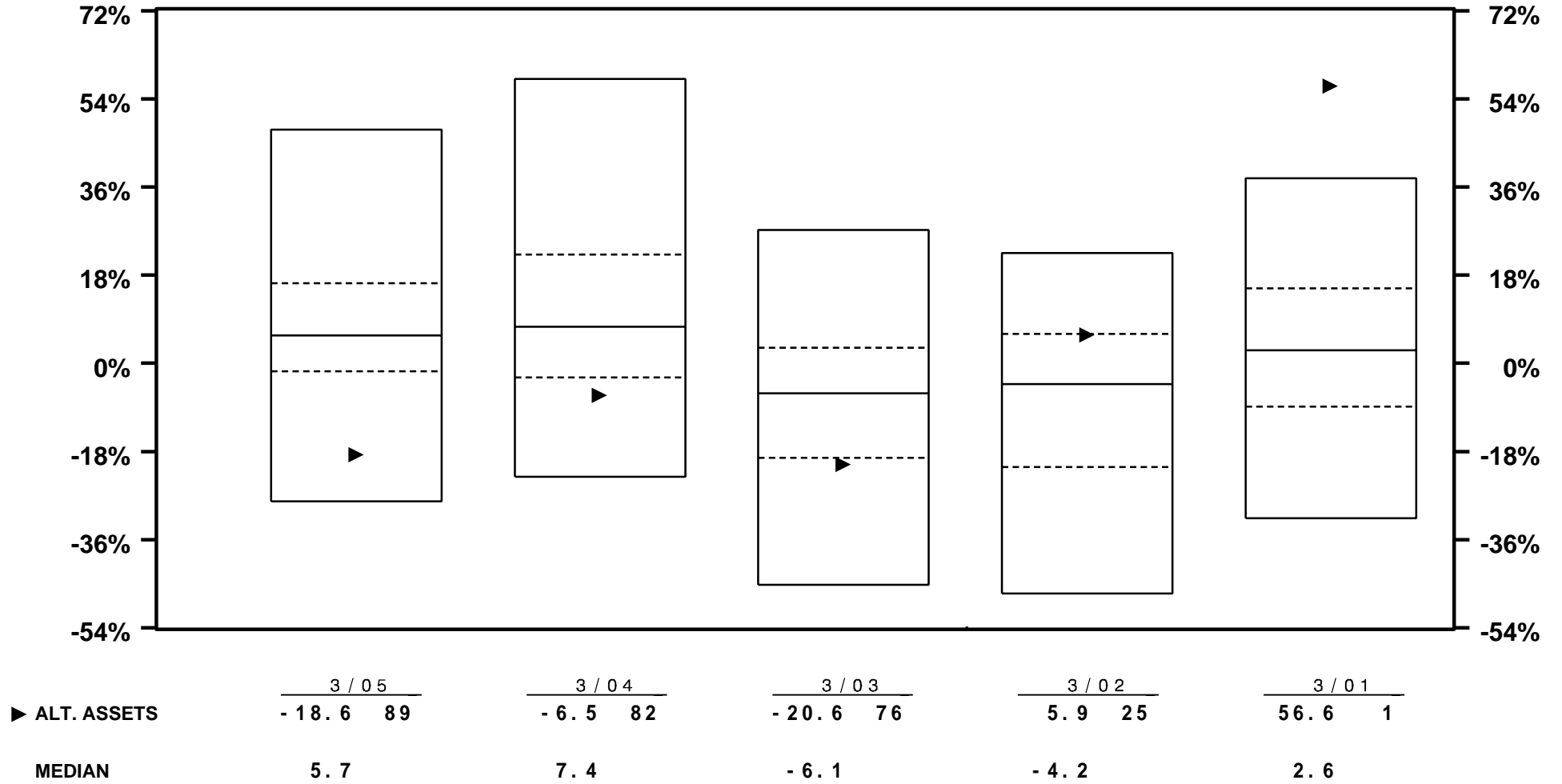

VERMONT MUNICIPAL EMPLOYEES

PRIVATE EQUITY FUNDS - TOTAL RATES OF RETURN

YEARS ENDING

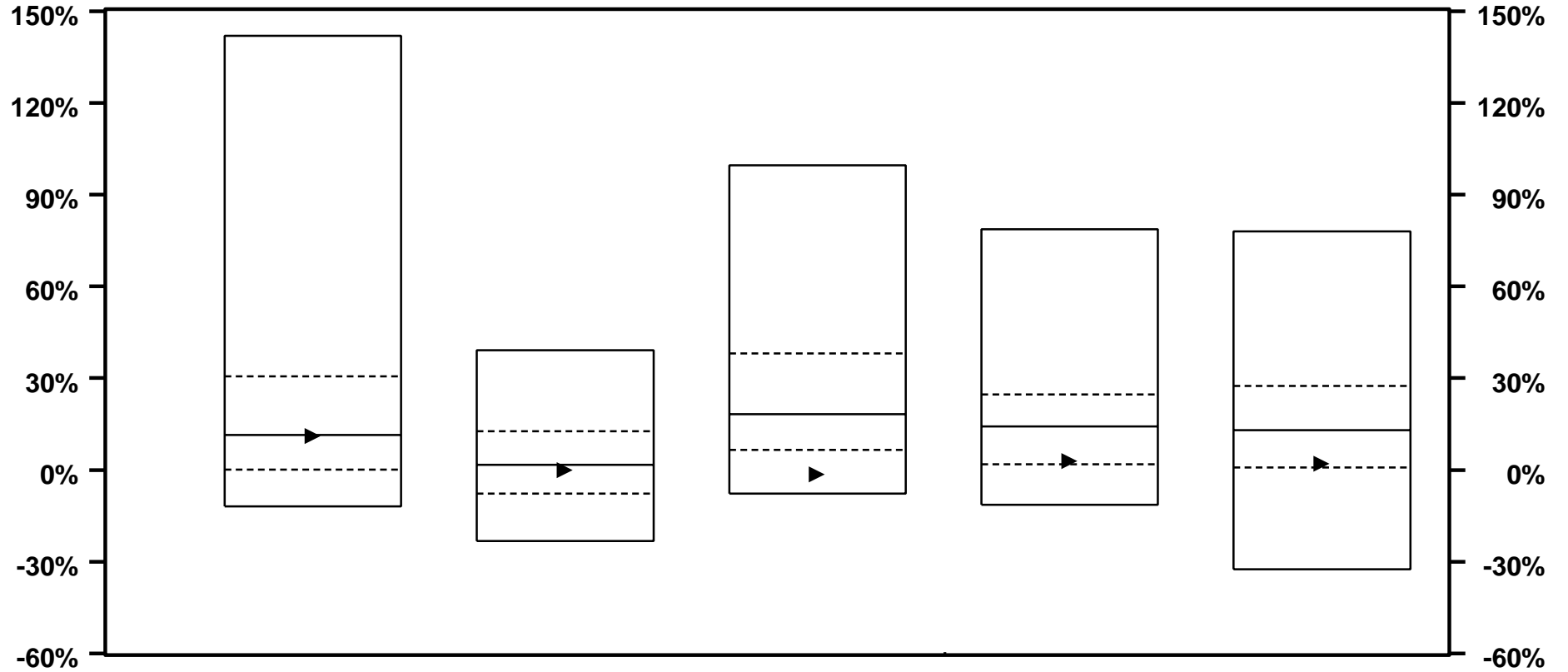

	<u>3 / 00</u>	<u>3 / 99</u>	<u>3 / 98</u>	<u>3 / 97</u>	<u>3 / 96</u>
▶ ALT. ASSETS	11.2 51	0.1 54	-1.3 87	3.1 66	2.1 70
MEDIAN	11.5	1.6	18.2	14.2	13.0

VERMONT MUNICIPAL EMPLOYEES

PRIVATE EQUITY FUNDS - TOTAL RETURN VS RISK

3 YEARS ENDING 3/05

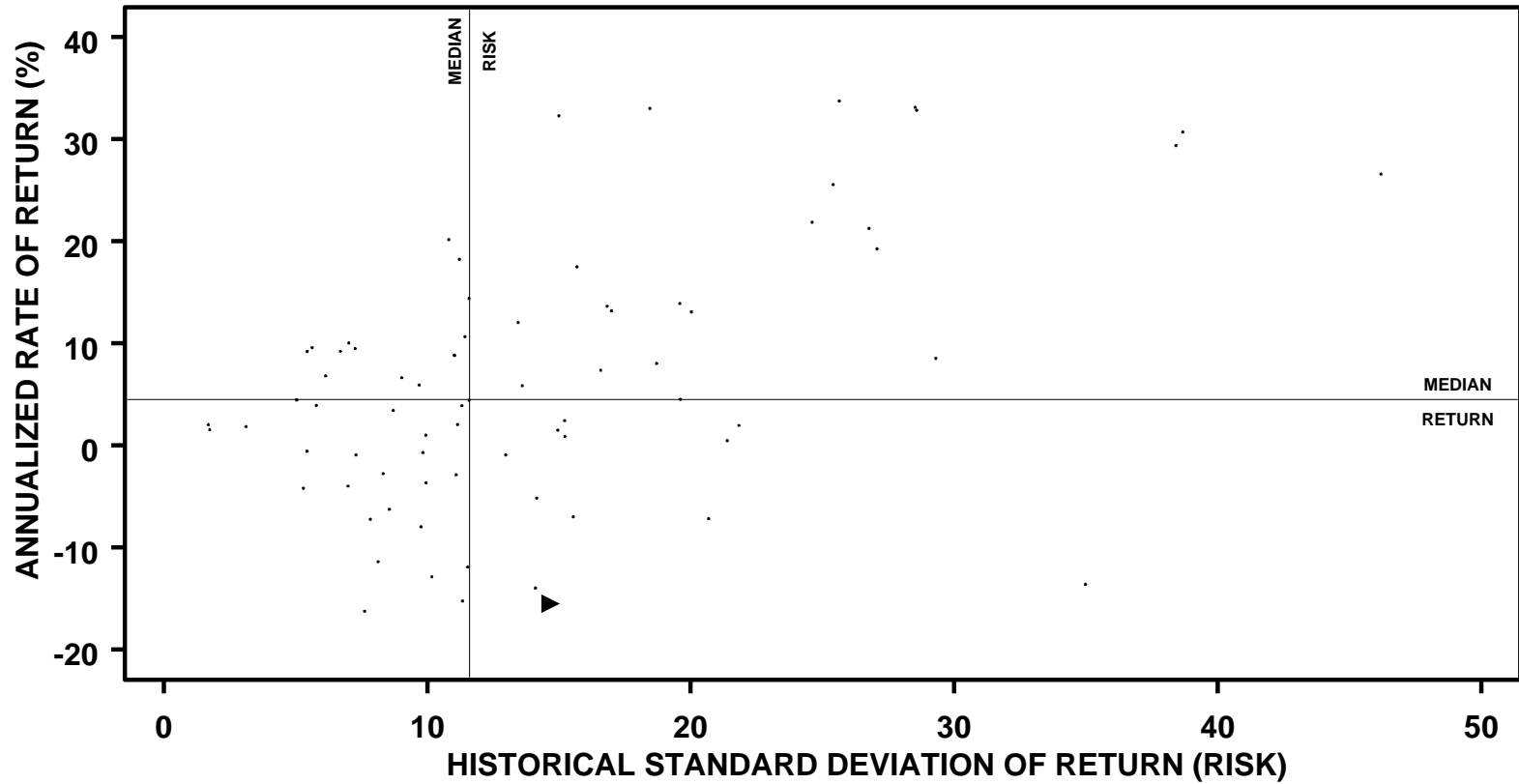

	ANNUALIZED RETURN		STANDARD DEVIATION		SHARPE RATIO	
	VALUE	RANK	VALUE	RANK	VALUE	RANK
▶ ALT. ASSETS	- 15.5	94	14.7	42	- 1.1	
MEDIAN	4.5		11.6		0.4	

VERMONT MUNICIPAL EMPLOYEES

PRIVATE EQUITY FUNDS - TOTAL RETURN VS RISK

5 YEARS ENDING 3/05

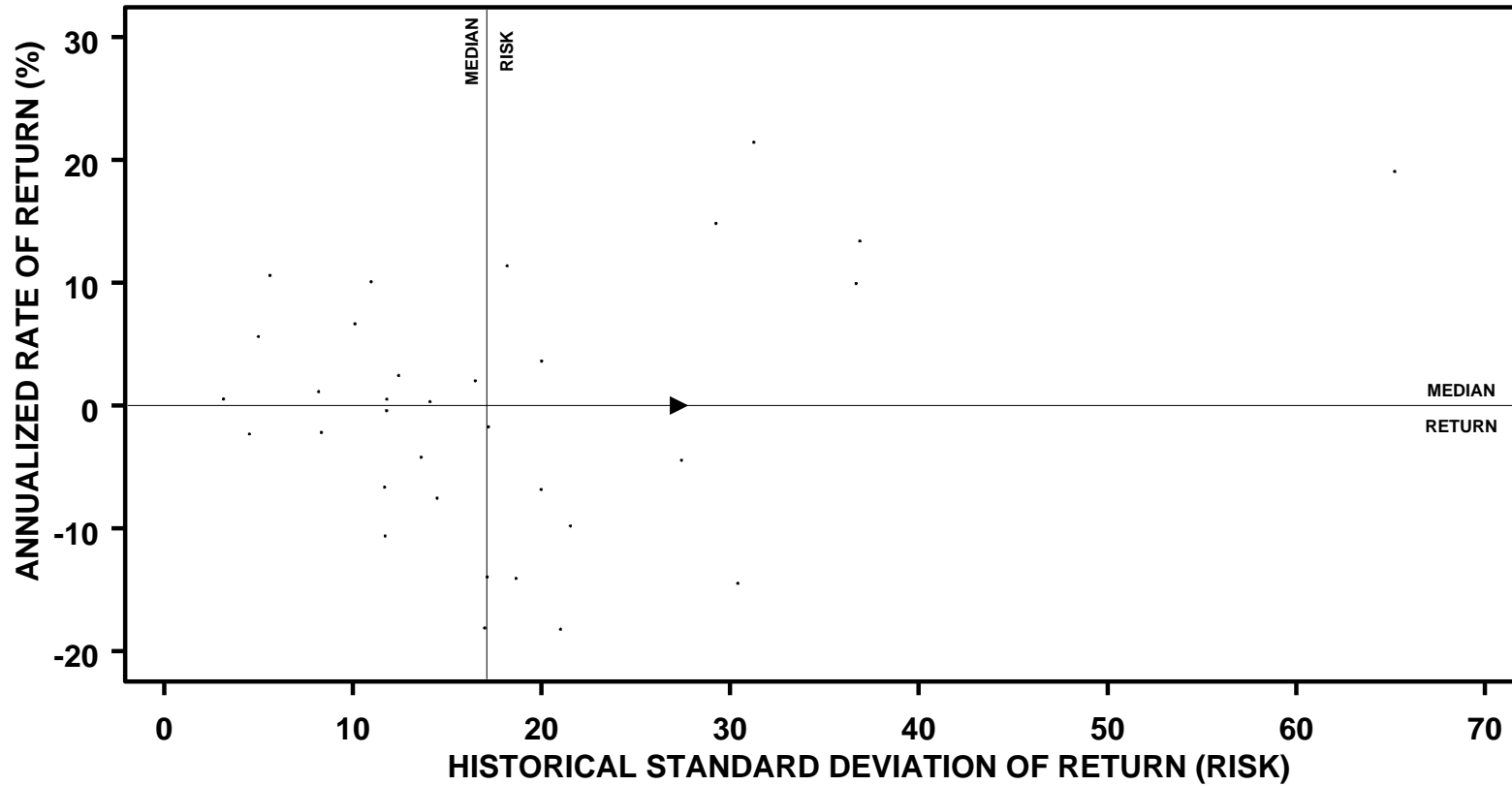

	ANNUALIZED RETURN		STANDARD DEVIATION		SHARPE RATIO	
	VALUE	RANK	VALUE	RANK	VALUE	RANK
▶ ALT. ASSETS	0.0	48	27.3	27	0.0	42
MEDIAN	0.0		17.1		-0.1	

VERMONT MUNICIPAL EMPLOYEES

REAL ESTATE FUNDS - RATES OF RETURN

PERIODS ENDING 3/05

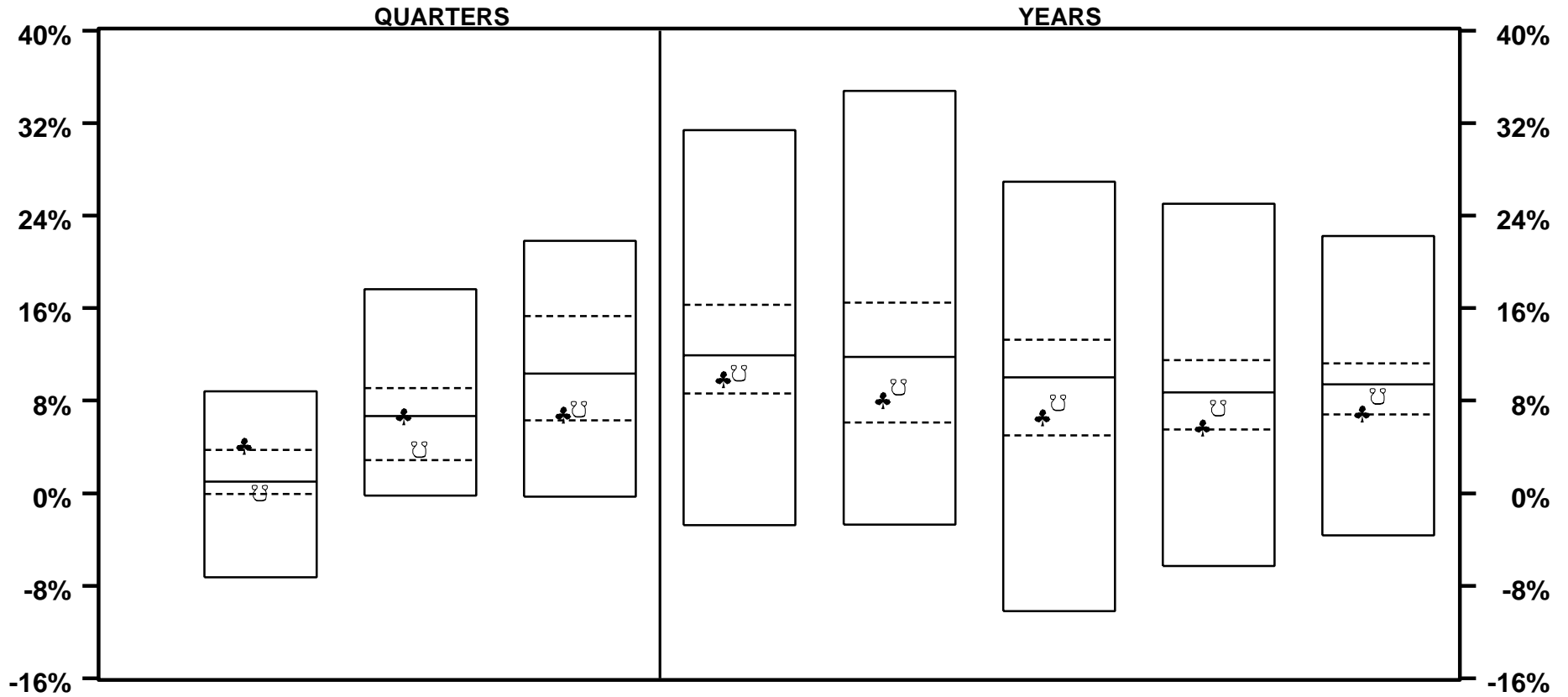

	LAST QTR		LAST 2 QTRS		LAST 3 QTRS		LAST YEAR		LAST 2 YEARS		LAST 3 YEARS		LAST 4 YEARS		LAST 5 YEARS	
♣ SSR TOWER FUND	4.1	20	6.6	50	6.8	69	9.9	67	8.1	71	6.6	67	5.7	72	6.9	72
○ NCREIF CL PROP	0.0	61	3.8	71	7.3	68	10.4	60	9.2	69	7.8	63	7.4	58	8.4	59
MEDIAN	1.0		6.7		10.3		11.9		11.8		10.0		8.7		9.4	

VERMONT MUNICIPAL EMPLOYEES

REAL ESTATE FUNDS - RATES OF RETURN

PERIODS ENDING 3/05

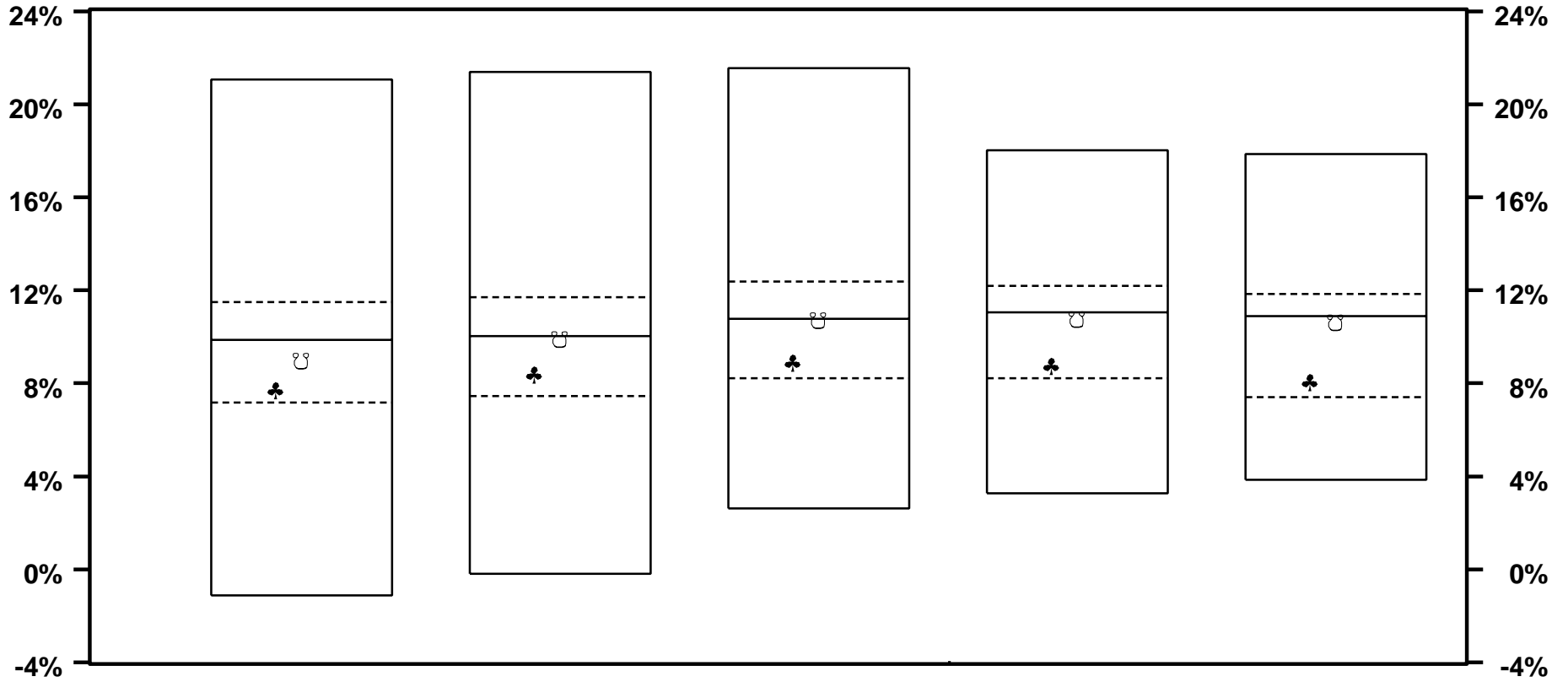

	LAST 6 YEARS		LAST 7 YEARS		LAST 8 YEARS		LAST 9 YEARS		LAST 10 YEARS	
♣ SSR TOWER FUND	7.7	67	8.4	63	8.9	66	8.7	67	8.0	72
○ NCREIF CL PROP	9.0	58	9.9	51	10.7	50	10.7	53	10.6	57
MEDIAN	9.9		10.0		10.8		11.1		10.9	

VERMONT MUNICIPAL EMPLOYEES

REAL ESTATE FUNDS - RATES OF RETURN

YEARS ENDING

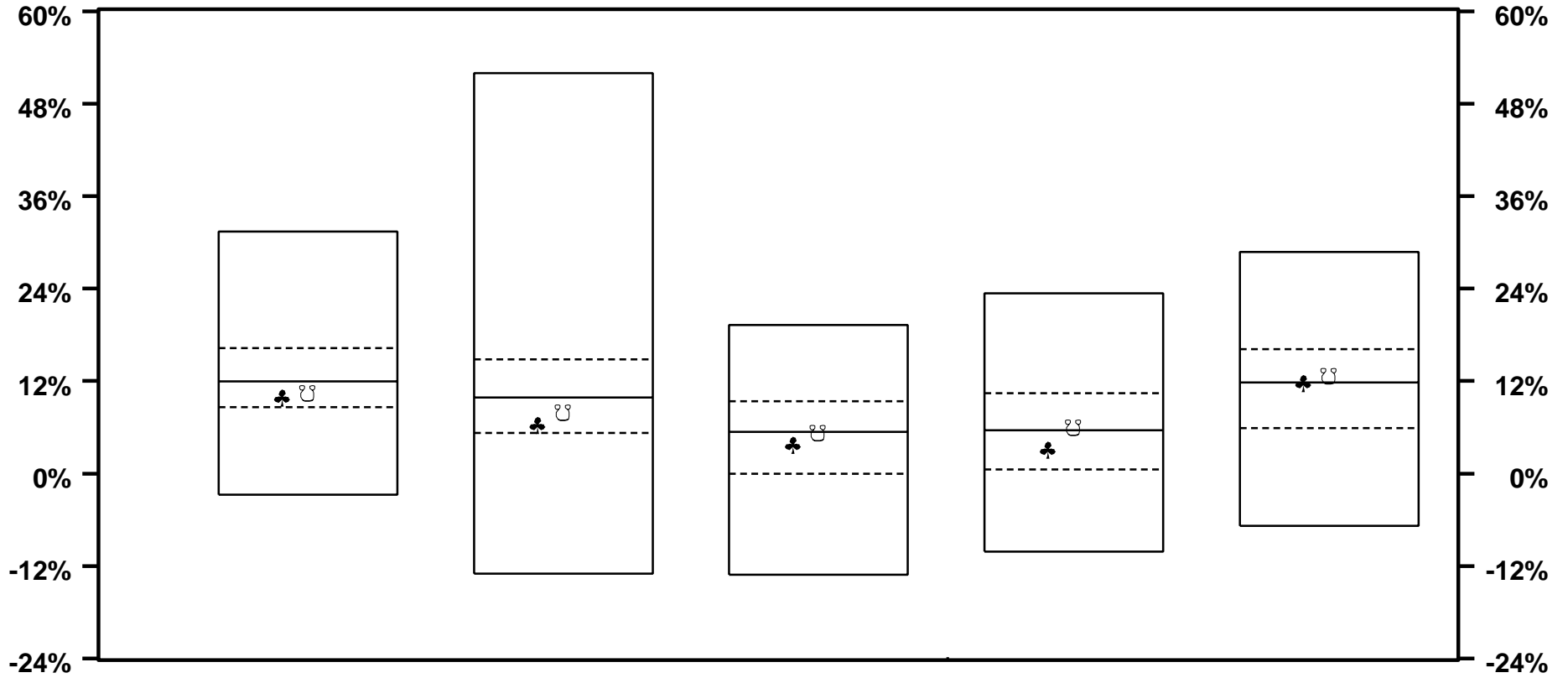

	3 / 05		3 / 04		3 / 03		3 / 02		3 / 01	
♣ SSR TOWER FUND	9.9	67	6.3	69	3.7	60	3.1	65	11.8	50
☵ NCREIF CL PROP	10.4	60	7.9	64	5.2	50	5.9	45	12.6	41
MEDIAN	11.9		9.8		5.4		5.6		11.8	

VERMONT MUNICIPAL EMPLOYEES

REAL ESTATE FUNDS - RATES OF RETURN

YEARS ENDING

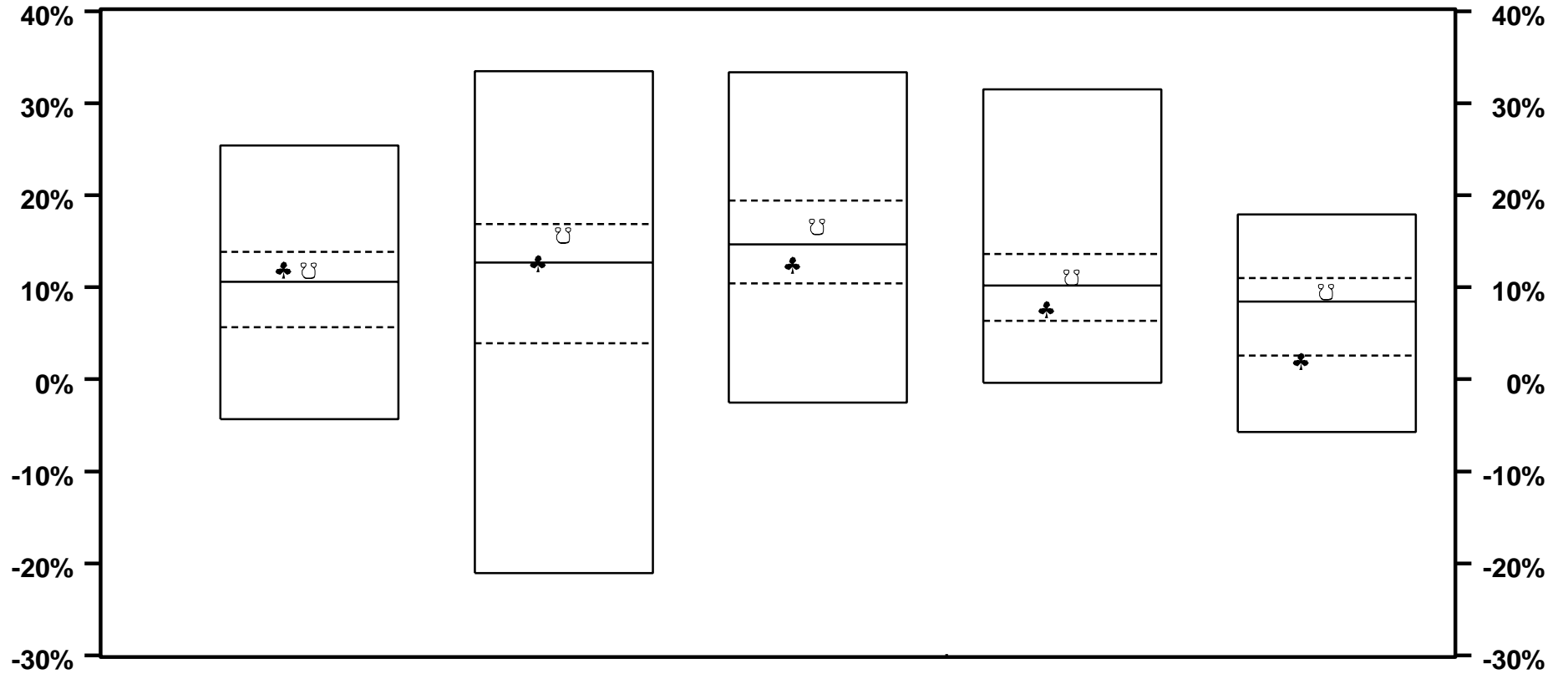

	3 / 00		3 / 99		3 / 98		3 / 97		3 / 96	
♣ SSR TOWER FUND	11.9	41	12.6	50	12.4	66	7.6	66	2.0	76
∩ NCREIF CL PROP	11.8	42	15.6	34	16.6	41	11.0	38	9.5	38
MEDIAN	10.6		12.7		14.7		10.2		8.4	

VERMONT MUNICIPAL EMPLOYEES

REAL ESTATE ONLY - RATES OF RETURN

PERIODS ENDING 3/05

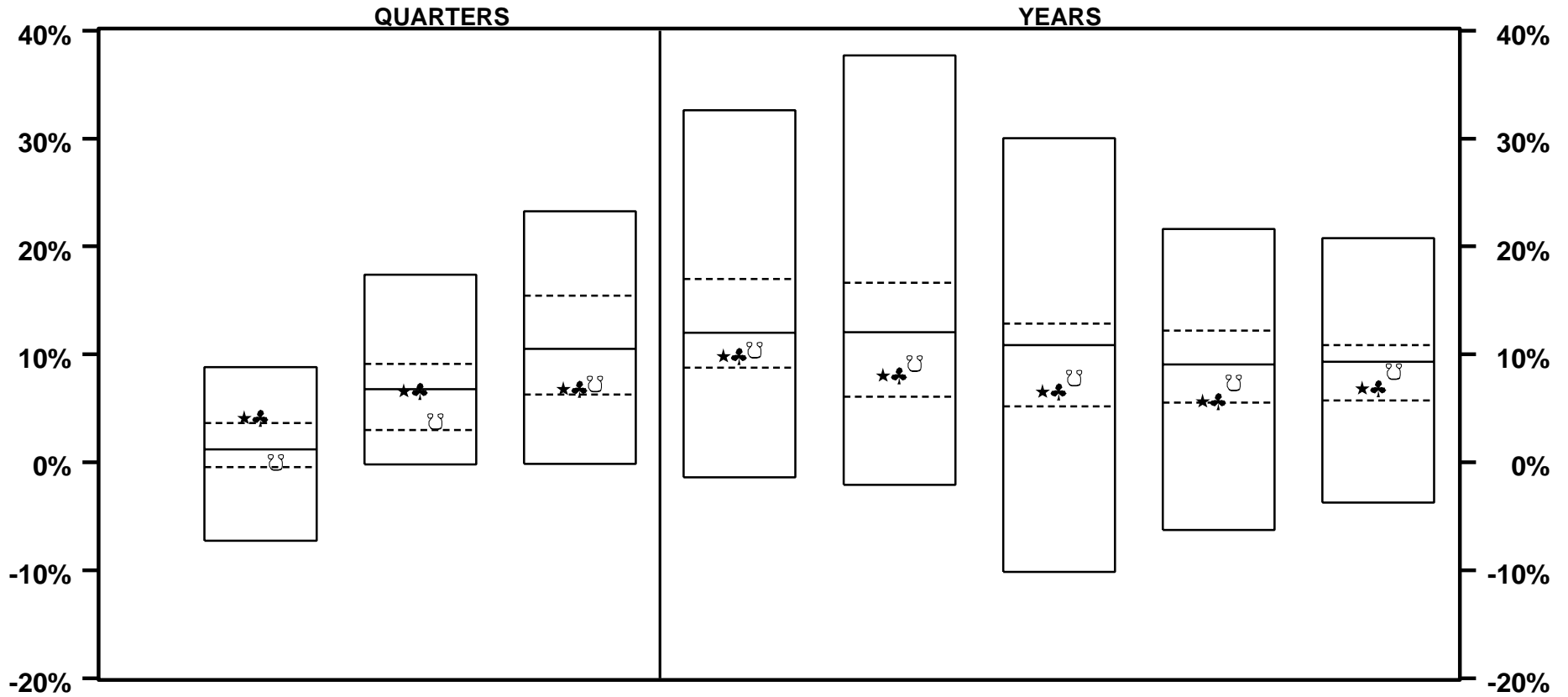

	LAST QTR		LAST 2 QTRS		LAST 3 QTRS		LAST YEAR		LAST 2 YEARS		LAST 3 YEARS		LAST 4 YEARS		LAST 5 YEARS	
★ MUNI COMPOSITE	4.1	20	6.6	51	6.8	70	9.9	70	8.1	71	6.6	69	5.7	73	6.9	70
♣ SSR TOWER FUND	4.1	20	6.6	51	6.8	70	9.9	70	8.1	71	6.6	69	5.7	73	6.9	70
∪ NCREIF CL PROP	0.0	60	3.8	71	7.3	69	10.4	63	9.2	69	7.8	67	7.4	63	8.4	56
MEDIAN	1.2		6.8		10.5		12.0		12.0		10.9		9.1		9.3	

VERMONT MUNICIPAL EMPLOYEES

REAL ESTATE ONLY - RATES OF RETURN

PERIODS ENDING 3/05

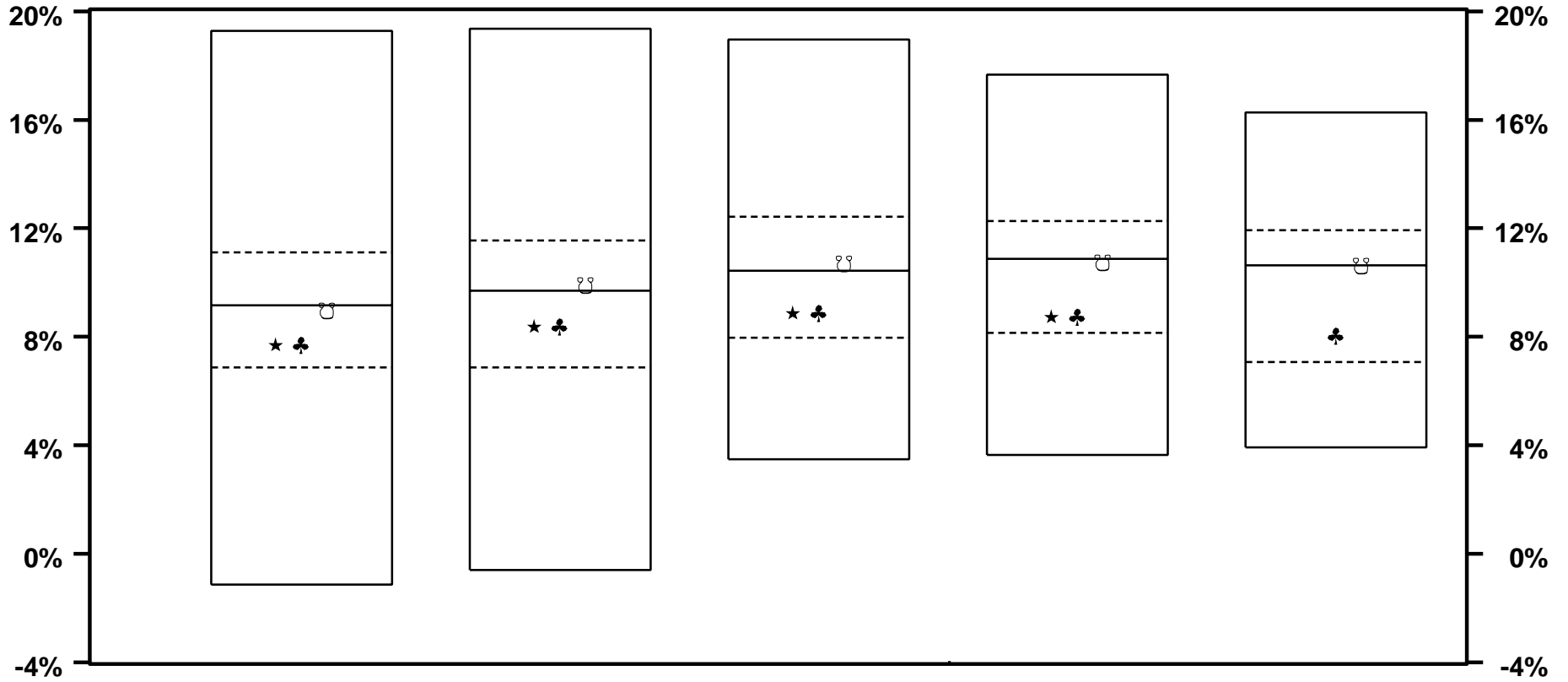

	LAST 6 YEARS		LAST 7 YEARS		LAST 8 YEARS		LAST 9 YEARS		LAST 10 YEARS	
★ MUNI COMPOSITE	7.7	65	8.4	59	8.9	64	8.7	66		
♣ SSR TOWER FUND	7.7	65	8.4	59	8.9	64	8.7	66	8.0	68
○ NCREIF CL PROP	9.0	54	9.9	46	10.7	47	10.7	51	10.6	51
MEDIAN	9.2		9.7		10.4		10.9		10.6	

VERMONT MUNICIPAL EMPLOYEES

REAL ESTATE ONLY - RATES OF RETURN

YEARS ENDING

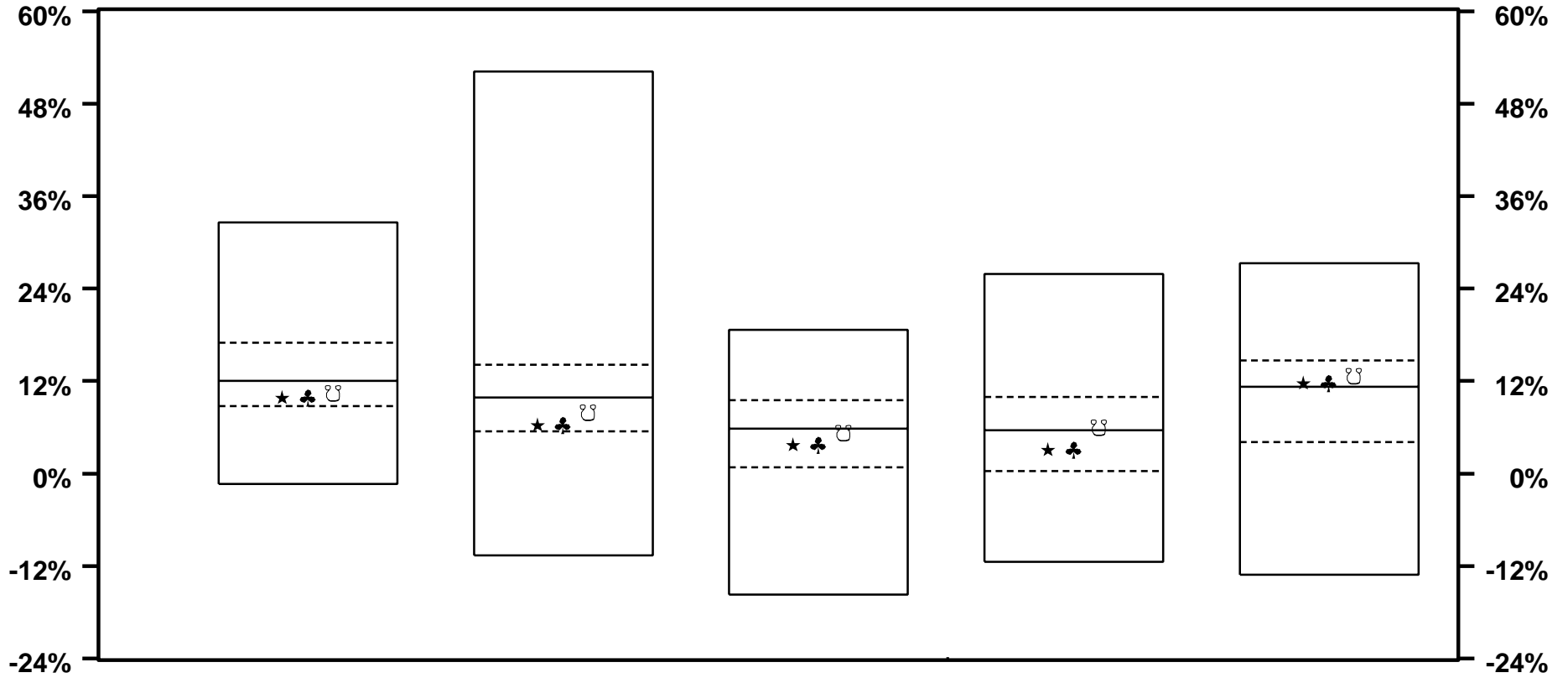

	3 / 05		3 / 04		3 / 03		3 / 02		3 / 01	
★ MUNI COMPOSITE	9.9	70	6.3	71	3.7	66	3.1	63	11.8	46
♣ SSR TOWER FUND	9.9	70	6.3	71	3.7	66	3.1	63	11.8	46
○ NCREIF CL PROP	10.4	63	7.9	65	5.2	54	5.9	43	12.6	37
MEDIAN	12.0		9.8		5.8		5.6		11.3	

VERMONT MUNICIPAL EMPLOYEES

REAL ESTATE ONLY - RATES OF RETURN

YEARS ENDING

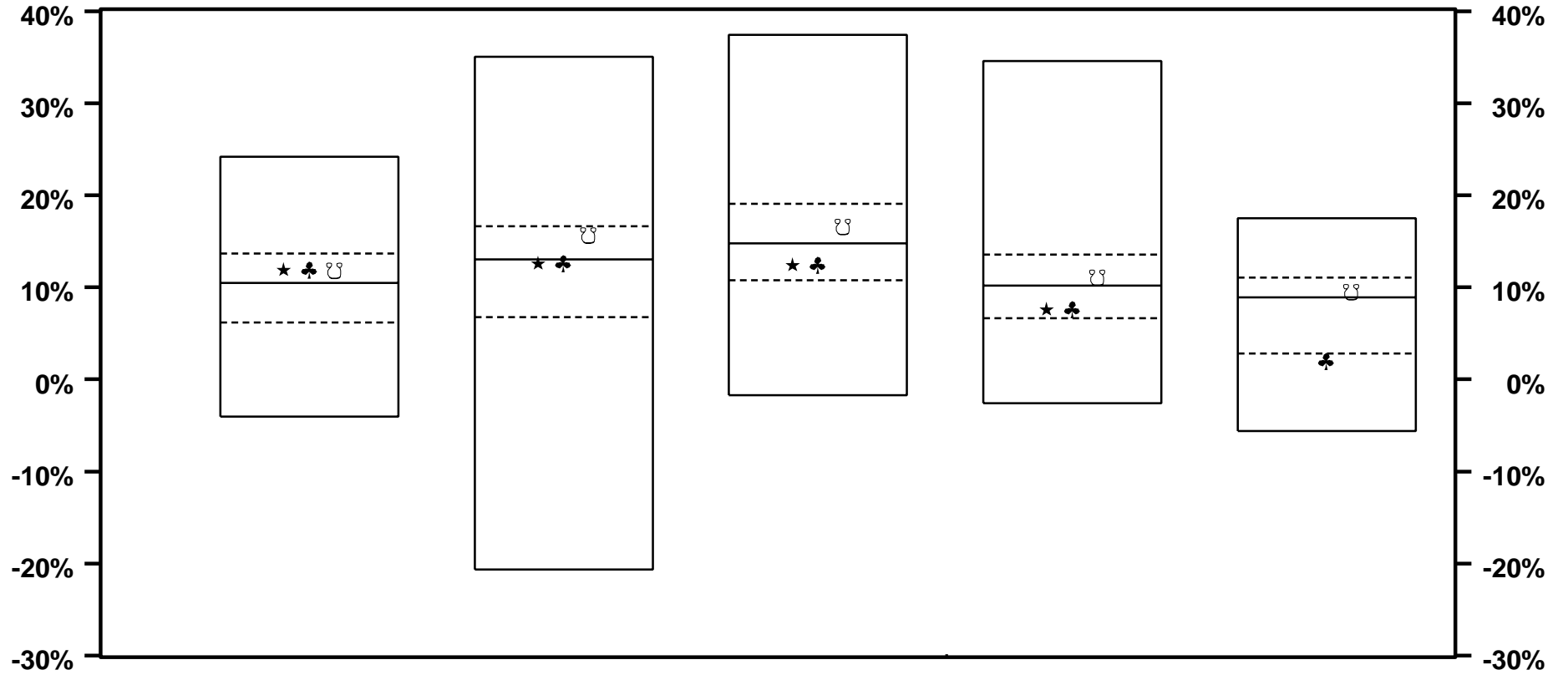

	3 / 00		3 / 99		3 / 98		3 / 97		3 / 96	
★ MUNI COMPOSITE	11.9	42	12.6	52	12.4	68	7.6	67		
♣ SSR TOWER FUND	11.9	42	12.6	52	12.4	68	7.6	67	2.0	77
☪ NCREIF CL PROP	11.8	43	15.6	35	16.6	41	11.0	37	9.5	41
MEDIAN	10.5		13.0		14.8		10.2		8.9	

VERMONT MUNICIPAL EMPLOYEES

REIT - EQUITY ONLY RATES OF RETURN

PERIODS ENDING 3/05

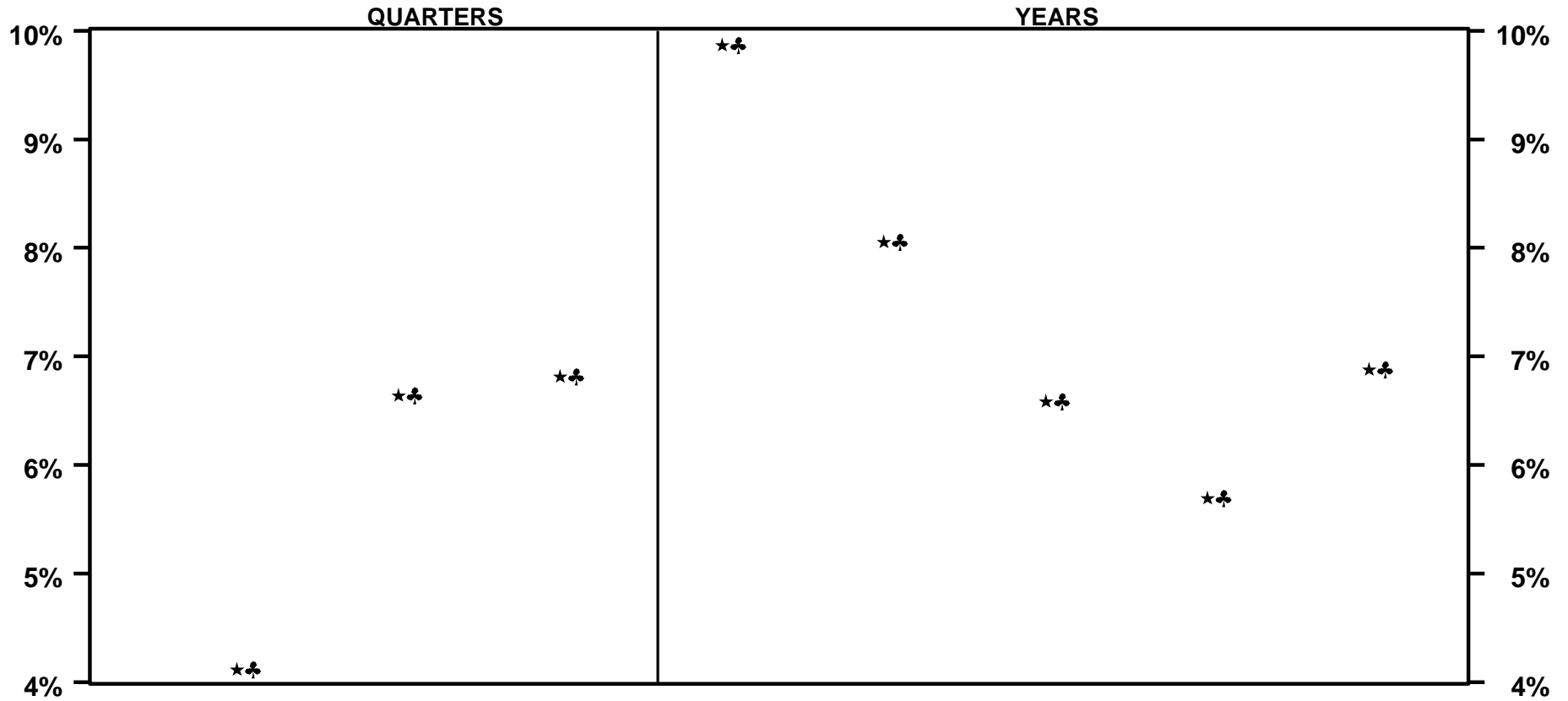

★ MUNI COMPOSITE
♣ SSR TOWER FUND

MEDIAN

VERMONT MUNICIPAL EMPLOYEES

REIT - EQUITY ONLY RATES OF RETURN

PERIODS ENDING 3/05

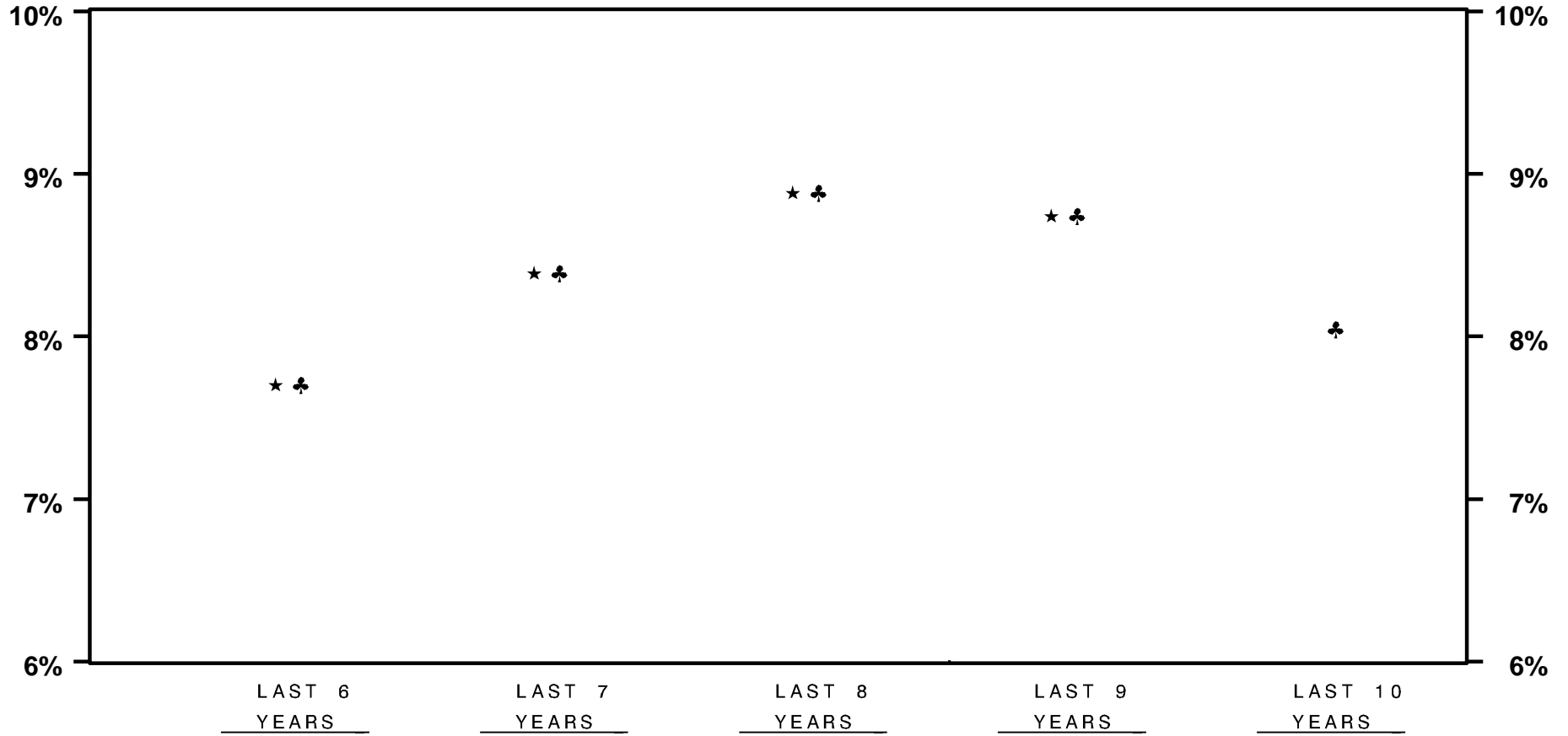

★ MUNI COMPOSITE
♣ SSR TOWER FUND

MEDIAN

VERMONT MUNICIPAL EMPLOYEES

REIT - EQUITY ONLY RATES OF RETURN

YEARS ENDING

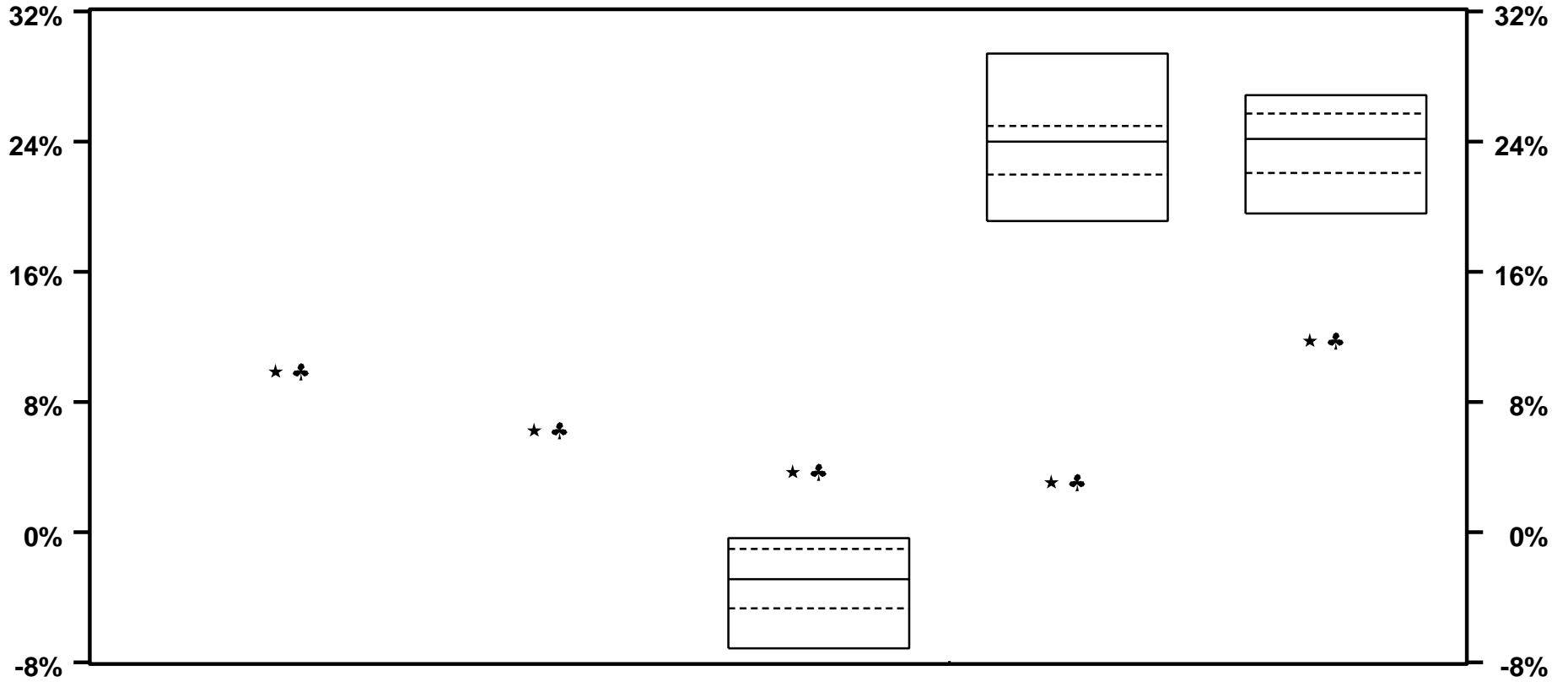

	<u>3 / 05</u>	<u>3 / 04</u>	<u>3 / 03</u>	<u>3 / 02</u>	<u>3 / 01</u>
★ MUNI COMPOSITE	9.9	6.3	3.7 5	3.1 95	11.8 95
♣ SSR TOWER FUND	9.9	6.3	3.7 5	3.1 95	11.8 95
 MEDIAN			 - 2.9	 24.0	 24.1

VERMONT MUNICIPAL EMPLOYEES

REIT - EQUITY ONLY RATES OF RETURN

YEARS ENDING

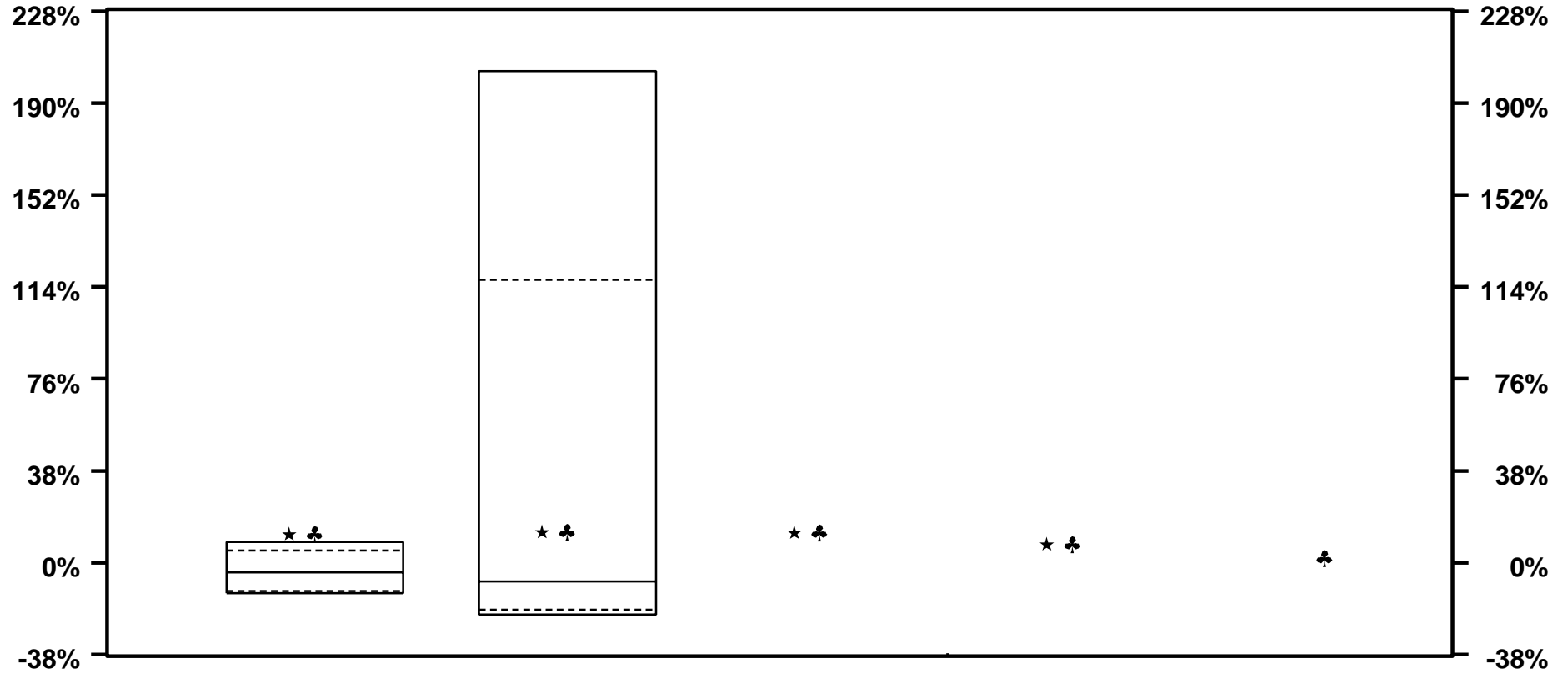

	3 / 00		3 / 99		3 / 98		3 / 97		3 / 96	
★ MUNI COMPOSITE	11.9	5	12.6	28	12.4		7.6			
♣ SSR TOWER FUND	11.9	5	12.6	28	12.4		7.6			2.0
MEDIAN	- 4.0		- 7.8							

VERMONT MUNICIPAL EMPLOYEES
EQUITY ONLY SUMMARY STATISTICS
QUARTER ENDING 3/05
MUNICIPAL SYSTEM COMPOSITE

	<u>PORTFOLIO</u>	<u>S&P 500</u>
TOTAL NUMBER OF SECURITIES	257	
TOTAL MARKET VALUE \$	100,221,499	
AVERAGE MARKET CAPITALIZATION (000's)	60,041,300	90,750,000
MEDIAN MARKET CAPITALIZATION (000's)		10,380,100
EQUITY SEGMENT YIELD	1.36	1.80
EQUITY SEGMENT P/E	19.37	17.70
EQUITY SEGMENT BETA	1.17	1.00
PRICE/BOOK RATIO	3.88	3.66
FIVE YEAR EARNINGS GROWTH	12.51	11.21
RETURN ON EQUITY	16.87	19.18

TEN LARGEST HOLDINGS

TEN BEST PERFORMERS

TEN WORST PERFORMERS

<u>NAME</u>	<u>\$</u>	<u>WEIGHT</u>	<u>NAME</u>	<u>RETURN</u>	<u>NAME</u>	<u>RETURN</u>
GENERAL ELEC CO COM	2,663,753	2.7	CUTERA INC COM	54.2	GRAFTECH INTL LTD	- 39.9
CITIGROUP INC	2,446,973	2.4	KERR MCGEE CORP COM	36.3	AVOCENT CORP	- 36.8
J P MORGAN CHASE &	2,259,100	2.3	BEVERLY ENTERPRISES	35.3	EBAY INC	- 35.9
MBNA CORP	1,946,373	1.9	WHITING PETE CORP N	34.8	C-CORNET CORP	- 34.6
DELL INC	1,726,269	1.7	VERITAS DOC INC	33.7	W HLDG CO INC	- 33.9
YAHOO INC	1,614,127	1.6	APPLE COMPUTER INC	29.4	WIRELESS FACS INC	- 33.8
MORGAN STANLEY	1,517,125	1.5	DENBURY RES INC DEL	28.3	AMIS HLDGS INC	- 31.7
CISCO SYS INC	1,508,238	1.5	ENERGY PARTNERS LTD	28.1	ALLIANCE GAMING COR	- 30.6
PFIZER INC	1,450,289	1.4	FOREST OIL CORP	27.7	VERITY INC	- 28.0
LOWES COS INC COM	1,370,473	1.4	HOT TOPIC INC	27.1	HANGER ORTHOPEDIC C	- 26.5

VERMONT MUNICIPAL EMPLOYEES
EQUITY ONLY SUMMARY STATISTICS
QUARTER ENDING 3/05
DOMESTIC EQUITY COMPOSITE

	PORTFOLIO	S&P 500
TOTAL NUMBER OF SECURITIES	255	
TOTAL MARKET VALUE \$	100,197,284	
AVERAGE MARKET CAPITALIZATION (000's)	60,055,800	90,750,000
MEDIAN MARKET CAPITALIZATION (000's)		10,380,100
EQUITY SEGMENT YIELD	1.36	1.80
EQUITY SEGMENT P/E	19.37	17.70
EQUITY SEGMENT BETA	1.17	1.00
PRICE/BOOK RATIO	3.88	3.66
FIVE YEAR EARNINGS GROWTH	12.51	11.21
RETURN ON EQUITY	16.87	19.18

TEN LARGEST HOLDINGS

TEN BEST PERFORMERS

TEN WORST PERFORMERS

NAME	\$	WEIGHT	NAME	RETURN	NAME	RETURN
GENERAL ELEC CO COM	2,663,753	2.7	CUTERA INC COM	54.2	GRAFTECH INTL LTD	-39.9
CITIGROUP INC	2,446,973	2.4	KERR MCGEE CORP COM	36.3	AVOCENT CORP	-36.8
J P MORGAN CHASE &	2,259,100	2.3	BEVERLY ENTERPRISES	35.3	EBAY INC	-35.9
MBNA CORP	1,946,373	1.9	WHITING PETE CORP N	34.8	C-CORNET CORP	-34.6
DELL INC	1,726,269	1.7	VERITAS DOC INC	33.7	W HLDG CO INC	-33.9
YAHOO INC	1,614,127	1.6	APPLE COMPUTER INC	29.4	WIRELESS FACS INC	-33.8
MORGAN STANLEY	1,517,125	1.5	DENBURY RES INC DEL	28.3	AMIS HLDGS INC	-31.7
CISCO SYS INC	1,508,238	1.5	ENERGY PARTNERS LTD	28.1	ALLIANCE GAMING COR	-30.6
PFIZER INC	1,450,289	1.4	FOREST OIL CORP	27.7	VERITY INC	-28.0
LOWES COS INC COM	1,370,473	1.4	HOT TOPIC INC	27.1	HANGER ORTHOPEDIC C	-26.5

VERMONT MUNICIPAL EMPLOYEES
EQUITY ONLY SUMMARY STATISTICS
QUARTER ENDING 3/05

DELAWARE

	<u>PORTFOLIO</u>	<u>R 1000(R) VALUE</u>
TOTAL NUMBER OF SECURITIES	56	
TOTAL MARKET VALUE	\$ 40,707,987	
AVERAGE MARKET CAPITALIZATION (000's)	90,111,200	92,088,600
MEDIAN MARKET CAPITALIZATION (000's)	30,919,100	4,400,200
EQUITY SEGMENT YIELD	2.28	2.40
EQUITY SEGMENT P/E	16.38	15.39
EQUITY SEGMENT BETA	0.98	0.92
PRICE/BOOK RATIO	3.56	2.60
FIVE YEAR EARNINGS GROWTH	6.67	9.36
RETURN ON EQUITY	19.32	16.26

TEN LARGEST HOLDINGS

TEN BEST PERFORMERS

TEN WORST PERFORMERS

<u>NAME</u>	<u>\$</u>	<u>WEIGHT</u>	<u>NAME</u>	<u>RETURN</u>	<u>NAME</u>	<u>RETURN</u>
GENERAL ELEC CO COM	1,676,136	4.1	KERR MCGEE CORP COM	36.3	GENERAL MTRS CORP C	- 25.6
CITIGROUP INC	1,599,864	3.9	MARATHON OIL CORP	25.6	WESTWOOD ONE INC	- 24.4
MORGAN STANLEY	1,517,125	3.7	GOODRICH CORP	17.9	MBNA CORP	- 12.4
J P MORGAN CHASE &	1,508,422	3.7	EXXON MOBIL CORP	16.8	INTERNATIONAL PAPER	- 11.8
MBNA CORP	1,133,103	2.8	NATIONAL SEMICONduc	14.9	J P MORGAN CHASE &	- 10.5
EXXON MOBIL CORP	1,131,446	2.8	CHEVRONTEXACO CORP	11.8	NEW YORK TIMES CO C	- 10.0
PFIZER INC	1,040,292	2.6	DOMINION RES INC VA	10.9	ORACLE CORP COM	- 9.0
BANK OF AMERICA COR	1,024,796	2.5	CIGNA CORP COM USD1	9.5	PMI GROUP INC	- 8.9
DOW CHEM CO COM	1,008,719	2.5	FPL GROUP INC COM	8.4	AMERICAN EXPRESS CO	- 8.5
WYETH	995,448	2.4	CLOROX CO COM	7.4	NIKE INC	- 7.9

VERMONT MUNICIPAL EMPLOYEES
EQUITY ONLY SUMMARY STATISTICS
QUARTER ENDING 3/05

ALLIANCE LARGE CAP GROWTH FUND

	PORTFOLIO	R 1000(R) GR
TOTAL NUMBER OF SECURITIES	57	
TOTAL MARKET VALUE	\$ 35,673,172	
AVERAGE MARKET CAPITALIZATION (000's)	65,034,700	70,710,200
MEDIAN MARKET CAPITALIZATION (000's)	27,291,800	4,356,400
EQUITY SEGMENT YIELD	0.70	1.06
EQUITY SEGMENT P/E	25.46	21.40
EQUITY SEGMENT BETA	1.32	1.13
PRICE/BOOK RATIO	5.01	4.83
FIVE YEAR EARNINGS GROWTH	21.68	13.99
RETURN ON EQUITY	17.17	21.70

TEN LARGEST HOLDINGS

TEN BEST PERFORMERS

TEN WORST PERFORMERS

NAME	\$	WEIGHT	NAME	RETURN	NAME	RETURN
DELL INC	1,726,269	4.8	APPLE COMPUTER INC	29.4	EBAY INC	-35.9
YAHOO INC	1,614,127	4.5	PULTE HOMES INC	15.5	JUNIPER NETWORKS IN	-18.9
LOWES COS INC COM	1,370,473	3.8	NABORS INDUSTRIES L	15.3	BOSTON SCIENTIFIC C	-17.6
ELECTRONIC ARTS INC	1,174,149	3.3	AVON PRODS INC COM	11.4	SYMANTEC CORP	-17.2
QUALCOMM INC	1,144,228	3.2	ALCON INC	10.8	STARBUCKS CORP	-17.2
AMGEN INC COM	1,075,518	3.0	HALLIBURTON CO COM	10.5	NETWORK APPLIANCE I	-16.7
CORNING INC	997,579	2.8	WELLPOINT INC	9.0	ELECTRONIC ARTS INC	-16.1
GENERAL ELEC CO COM	987,617	2.8	DREAMWORKS ANIMATIO	8.5	AMERICAN INTL GROUP	-15.5
AVON PRODS INC COM	933,626	2.6	UNITEDHEALTH GROUP	8.4	UNITED PARCEL SVC I	-14.5
JUNIPER NETWORKS IN	913,994	2.6	MARVELL TECHNOLOGY	8.1	ST JUDE MED INC COM	-14.1

VERMONT MUNICIPAL EMPLOYEES
EQUITY ONLY SUMMARY STATISTICS
QUARTER ENDING 3/05

LAZARD SMALL CAP FUND

	PORTFOLIO	R 2000(R)
TOTAL NUMBER OF SECURITIES	151	
TOTAL MARKET VALUE	\$ 23,816,125	
AVERAGE MARKET CAPITALIZATION (000's)	1,225,500	1,052,800
MEDIAN MARKET CAPITALIZATION (000's)	1,064,300	523,800
EQUITY SEGMENT YIELD	0.75	1.15
EQUITY SEGMENT P/E	18.40	17.08
EQUITY SEGMENT BETA	1.26	1.13
PRICE/BOOK RATIO	2.77	2.91
FIVE YEAR EARNINGS GROWTH	8.58	9.57
RETURN ON EQUITY	12.27	11.53

TEN LARGEST HOLDINGS

TEN BEST PERFORMERS

TEN WORST PERFORMERS

<u>NAME</u>	<u>\$</u>	<u>WEIGHT</u>	<u>NAME</u>	<u>RETURN</u>	<u>NAME</u>	<u>RETURN</u>
ADVO INC	360,353	1.5	CUTERA INC COM	54.2	GRAFTECH INTL LTD	- 39.9
KEY ENERGY GROUP IN	354,197	1.5	BEVERLY ENTERPRISES	35.3	AVOCENT CORP	- 36.8
BEVERLY ENTERPRISES	343,399	1.4	WHITING PETE CORP N	34.8	C-CORNET CORP	- 34.6
ARBITRON INC	336,096	1.4	VERITAS DOC INC	33.7	W HLDG CO INC	- 33.9
KINDRED HEALTHCARE	323,564	1.4	DENBURY RES INC DEL	28.3	WIRELESS FACS INC	- 33.8
LIFEPOINT HOSPS INC	321,588	1.4	ENERGY PARTNERS LTD	28.1	AMIS HLDGS INC	- 31.7
PACER INTL INC TENN	315,440	1.3	FOREST OIL CORP	27.7	ALLIANCE GAMING COR	- 30.6
KOMAG INC	296,169	1.2	HOT TOPIC INC	27.1	VERITY INC	- 28.0
DRS TECHNOLOGIES IN	281,971	1.2	LIFEPOINT HOSPS INC	25.9	HANGER ORTHOPEDIC C	- 26.5
SERENA SOFTWARE INC	281,265	1.2	GREY WOLF INC	24.9	SPARTECH CORP	- 26.3

VERMONT MUNICIPAL EMPLOYEES
DOMESTIC EQUITY ONLY SUMMARY STATISTICS
QUARTER ENDING 3/05

MUNICIPAL SYSTEM COMPOSITE

	<u>PORTFOLIO</u>	<u>S&P 500</u>
TOTAL NUMBER OF SECURITIES	257	
TOTAL MARKET VALUE \$	100,221,499	
AVERAGE MARKET CAPITALIZATION (000's)	61,000,900	91,493,200
MEDIAN MARKET CAPITALIZATION (000's)		10,380,100
EQUITY SEGMENT YIELD	1.37	1.80
EQUITY SEGMENT P/E	19.37	17.66
EQUITY SEGMENT BETA	1.17	1.00
PRICE/BOOK RATIO	3.91	3.66
FIVE YEAR EARNINGS GROWTH	12.52	11.31
RETURN ON EQUITY	16.94	19.25

TEN LARGEST HOLDINGS

TEN BEST PERFORMERS

TEN WORST PERFORMERS

<u>NAME</u>	<u>\$</u>	<u>WEIGHT</u>	<u>NAME</u>	<u>RETURN</u>	<u>NAME</u>	<u>RETURN</u>
GENERAL ELEC CO COM	2,663,753	2.7	CUTERA INC COM	54.2	GRAFTECH INTL LTD	- 39.9
CITIGROUP INC	2,446,973	2.4	KERR MCGEE CORP COM	36.3	AVOCENT CORP	- 36.8
J P MORGAN CHASE &	2,259,100	2.3	BEVERLY ENTERPRISES	35.3	EBAY INC	- 35.9
MBNA CORP	1,946,373	1.9	WHITING PETE CORP N	34.8	C-CORNET CORP	- 34.6
DELL INC	1,726,269	1.7	VERITAS DOC INC	33.7	W HLDG CO INC	- 33.9
YAHOO INC	1,614,127	1.6	APPLE COMPUTER INC	29.4	WIRELESS FACS INC	- 33.8
MORGAN STANLEY	1,517,125	1.5	DENBURY RES INC DEL	28.3	AMIS HLDGS INC	- 31.7
CISCO SYS INC	1,508,238	1.5	ENERGY PARTNERS LTD	28.1	ALLIANCE GAMING COR	- 30.6
PFIZER INC	1,450,289	1.4	FOREST OIL CORP	27.7	VERITY INC	- 28.0
LOWES COS INC COM	1,370,473	1.4	HOT TOPIC INC	27.1	HANGER ORTHOPEDIC C	- 26.5

VERMONT MUNICIPAL EMPLOYEES
DOMESTIC EQUITY ONLY SUMMARY STATISTICS
QUARTER ENDING 3/05

DOMESTIC EQUITY COMPOSITE

	PORTFOLIO	S&P 500
TOTAL NUMBER OF SECURITIES	255	
TOTAL MARKET VALUE \$	100,197,284	
AVERAGE MARKET CAPITALIZATION (000's)	61,000,900	91,493,200
MEDIAN MARKET CAPITALIZATION (000's)		10,380,100
EQUITY SEGMENT YIELD	1.37	1.80
EQUITY SEGMENT P/E	19.37	17.66
EQUITY SEGMENT BETA	1.17	1.00
PRICE/BOOK RATIO	3.91	3.66
FIVE YEAR EARNINGS GROWTH	12.52	11.31
RETURN ON EQUITY	16.94	19.25

TEN LARGEST HOLDINGS

TEN BEST PERFORMERS

TEN WORST PERFORMERS

<u>NAME</u>	<u>\$</u>	<u>WEIGHT</u>	<u>NAME</u>	<u>RETURN</u>	<u>NAME</u>	<u>RETURN</u>
GENERAL ELEC CO COM	2,663,753	2.7	CUTERA INC COM	54.2	GRAFTECH INTL LTD	- 39.9
CITIGROUP INC	2,446,973	2.4	KERR MCGEE CORP COM	36.3	AVOCENT CORP	- 36.8
J P MORGAN CHASE &	2,259,100	2.3	BEVERLY ENTERPRISES	35.3	EBAY INC	- 35.9
MBNA CORP	1,946,373	1.9	WHITING PETE CORP N	34.8	C-CORNET CORP	- 34.6
DELL INC	1,726,269	1.7	VERITAS DOC INC	33.7	W HLDG CO INC	- 33.9
YAHOO INC	1,614,127	1.6	APPLE COMPUTER INC	29.4	WIRELESS FACS INC	- 33.8
MORGAN STANLEY	1,517,125	1.5	DENBURY RES INC DEL	28.3	AMIS HLDGS INC	- 31.7
CISCO SYS INC	1,508,238	1.5	ENERGY PARTNERS LTD	28.1	ALLIANCE GAMING COR	- 30.6
PFIZER INC	1,450,289	1.4	FOREST OIL CORP	27.7	VERITY INC	- 28.0
LOWES COS INC COM	1,370,473	1.4	HOT TOPIC INC	27.1	HANGER ORTHOPEDIC C	- 26.5

VERMONT MUNICIPAL EMPLOYEES
DOMESTIC EQUITY ONLY SUMMARY STATISTICS
QUARTER ENDING 3/05

DELAWARE

	<u>PORTFOLIO</u>	<u>R 1000(R) VALUE</u>
TOTAL NUMBER OF SECURITIES	56	
TOTAL MARKET VALUE	\$ 40,707,987	
AVERAGE MARKET CAPITALIZATION (000's)	90,111,200	92,093,800
MEDIAN MARKET CAPITALIZATION (000's)	30,919,100	4,394,800
EQUITY SEGMENT YIELD	2.28	2.40
EQUITY SEGMENT P/E	16.38	15.39
EQUITY SEGMENT BETA	0.98	0.92
PRICE/BOOK RATIO	3.56	2.60
FIVE YEAR EARNINGS GROWTH	6.67	9.35
RETURN ON EQUITY	19.32	16.25

TEN LARGEST HOLDINGS

TEN BEST PERFORMERS

TEN WORST PERFORMERS

<u>NAME</u>	<u>\$</u>	<u>WEIGHT</u>	<u>NAME</u>	<u>RETURN</u>	<u>NAME</u>	<u>RETURN</u>
GENERAL ELEC CO COM	1,676,136	4.1	KERR MCGEE CORP COM	36.3	GENERAL MTRS CORP C	- 25.6
CITIGROUP INC	1,599,864	3.9	MARATHON OIL CORP	25.6	WESTWOOD ONE INC	- 24.4
MORGAN STANLEY	1,517,125	3.7	GOODRICH CORP	17.9	MBNA CORP	- 12.4
J P MORGAN CHASE &	1,508,422	3.7	EXXON MOBIL CORP	16.8	INTERNATIONAL PAPER	- 11.8
MBNA CORP	1,133,103	2.8	NATIONAL SEMICONDC	14.9	J P MORGAN CHASE &	- 10.5
EXXON MOBIL CORP	1,131,446	2.8	CHEVRONTEXACO CORP	11.8	NEW YORK TIMES CO C	- 10.0
PFIZER INC	1,040,292	2.6	DOMINION RES INC VA	10.9	ORACLE CORP COM	- 9.0
BANK OF AMERICA COR	1,024,796	2.5	CIGNA CORP COM USD1	9.5	PMI GROUP INC	- 8.9
DOW CHEM CO COM	1,008,719	2.5	FPL GROUP INC COM	8.4	AMERICAN EXPRESS CO	- 8.5
WYETH	995,448	2.4	CLOROX CO COM	7.4	NIKE INC	- 7.9

VERMONT MUNICIPAL EMPLOYEES
DOMESTIC EQUITY ONLY SUMMARY STATISTICS
QUARTER ENDING 3/05

ALLIANCE LARGE CAP GROWTH FUND

	PORTFOLIO	R 1000(R) GR
TOTAL NUMBER OF SECURITIES	57	
TOTAL MARKET VALUE	\$ 35,673,172	
AVERAGE MARKET CAPITALIZATION (000's)	66,462,400	70,734,900
MEDIAN MARKET CAPITALIZATION (000's)	27,291,800	4,356,400
EQUITY SEGMENT YIELD	0.70	1.06
EQUITY SEGMENT P/E	25.46	21.40
EQUITY SEGMENT BETA	1.31	1.13
PRICE/BOOK RATIO	5.07	4.83
FIVE YEAR EARNINGS GROWTH	21.99	13.98
RETURN ON EQUITY	17.47	21.70

TEN LARGEST HOLDINGS

TEN BEST PERFORMERS

TEN WORST PERFORMERS

NAME	\$	WEIGHT	NAME	RETURN	NAME	RETURN
DELL INC	1,726,269	4.8	APPLE COMPUTER INC	29.4	EBAY INC	-35.9
YAHOO INC	1,614,127	4.5	PULTE HOMES INC	15.5	JUNIPER NETWORKS IN	-18.9
LOWES COS INC COM	1,370,473	3.8	NABORS INDUSTRIES L	15.3	BOSTON SCIENTIFIC C	-17.6
ELECTRONIC ARTS INC	1,174,149	3.3	AVON PRODS INC COM	11.4	SYMANTEC CORP	-17.2
QUALCOMM INC	1,144,228	3.2	ALCON INC	10.8	STARBUCKS CORP	-17.2
AMGEN INC COM	1,075,518	3.0	HALLIBURTON CO COM	10.5	NETWORK APPLIANCE I	-16.7
CORNING INC	997,579	2.8	WELLPOINT INC	9.0	ELECTRONIC ARTS INC	-16.1
GENERAL ELEC CO COM	987,617	2.8	DREAMWORKS ANIMATIO	8.5	AMERICAN INTL GROUP	-15.5
AVON PRODS INC COM	933,626	2.6	UNITEDHEALTH GROUP	8.4	UNITED PARCEL SVC I	-14.5
JUNIPER NETWORKS IN	913,994	2.6	MARVELL TECHNOLOGY	8.1	ST JUDE MED INC COM	-14.1

VERMONT MUNICIPAL EMPLOYEES
DOMESTIC EQUITY ONLY SUMMARY STATISTICS
QUARTER ENDING 3/05

LAZARD SMALL CAP FUND

	PORTFOLIO	R 2000(R)
TOTAL NUMBER OF SECURITIES	151	
TOTAL MARKET VALUE	\$ 23,816,125	
AVERAGE MARKET CAPITALIZATION (000's)	1,213,200	1,048,800
MEDIAN MARKET CAPITALIZATION (000's)	1,057,000	523,500
EQUITY SEGMENT YIELD	0.76	1.15
EQUITY SEGMENT P/E	18.40	17.06
EQUITY SEGMENT BETA	1.28	1.13
PRICE/BOOK RATIO	2.81	2.91
FIVE YEAR EARNINGS GROWTH	8.33	9.48
RETURN ON EQUITY	11.97	11.54

TEN LARGEST HOLDINGS

TEN BEST PERFORMERS

TEN WORST PERFORMERS

NAME	\$	WEIGHT	NAME	RETURN	NAME	RETURN
ADVO INC	360,353	1.5	CUTERA INC COM	54.2	GRAFTECH INTL LTD	-39.9
KEY ENERGY GROUP IN	354,197	1.5	BEVERLY ENTERPRISES	35.3	AVOCENT CORP	-36.8
BEVERLY ENTERPRISES	343,399	1.4	WHITING PETE CORP N	34.8	C-CORNET CORP	-34.6
ARBITRON INC	336,096	1.4	VERITAS DOC INC	33.7	W HLDG CO INC	-33.9
KINDRED HEALTHCARE	323,564	1.4	DENBURY RES INC DEL	28.3	WIRELESS FACS INC	-33.8
LIFEPOINT HOSPS INC	321,588	1.4	ENERGY PARTNERS LTD	28.1	AMIS HLDGS INC	-31.7
PACER INTL INC TENN	315,440	1.3	FOREST OIL CORP	27.7	ALLIANCE GAMING COR	-30.6
KOMAG INC	296,169	1.2	HOT TOPIC INC	27.1	VERITY INC	-28.0
DRS TECHNOLOGIES IN	281,971	1.2	LIFEPOINT HOSPS INC	25.9	HANGER ORTHOPEDIC C	-26.5
SERENA SOFTWARE INC	281,265	1.2	GREY WOLF INC	24.9	SPARTECH CORP	-26.3

VERMONT MUNICIPAL EMPLOYEES

EQUITY PORTFOLIO CHARACTERISTICS

PERIODS ENDING 3/05

DIVIDEND YIELD

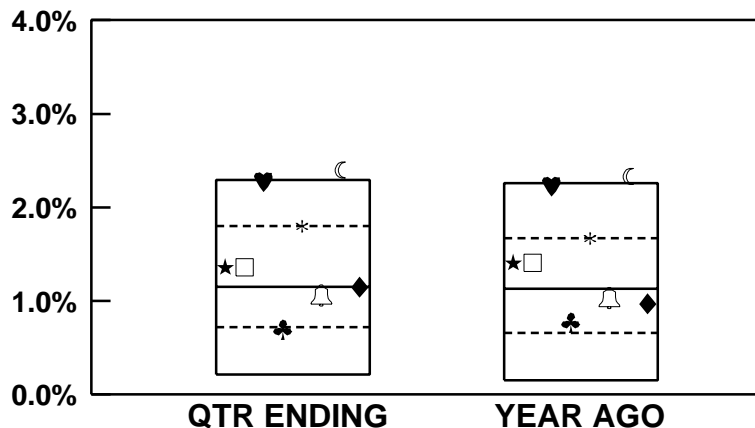

CAPITALIZATION

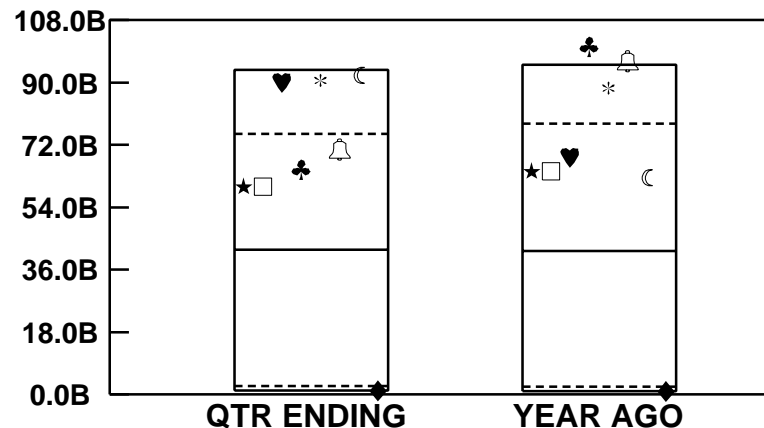

EFFECTS ON RETURN

- H
- MH
- ML
- L

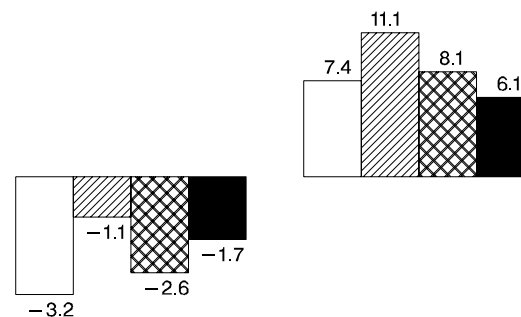
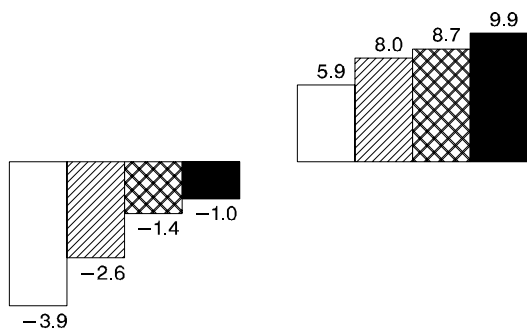

★ MUNI COMPOSITE	1.36	41	1.41	39	60.04	35	64.36	35
□ EQTY COMPOSITE	1.36	41	1.41	39	60.06	35	64.37	35
♥ DELAWARE	2.28	5	2.23	5	90.11	14	68.56	32
♣ ALLIANCE	0.70	76	0.77	68	65.03	31	100.39	3
* S&P 500	1.80	26	1.67	21	90.75	13	88.48	9
🔔 R 1000(R) GR	1.06	53	1.03	54	70.71	28	96.23	4
☾ R 1000(R) VALUE	2.40	2	2.33	3	92.09	5	62.66	36
◆ R 2000(R)	1.15	50	0.97	57	1.05	94	0.95	95
MEDIAN	1.15		1.13		41.82		41.35	

VERMONT MUNICIPAL EMPLOYEES

EQUITY PORTFOLIO CHARACTERISTICS

PERIODS ENDING 3/05

DIVIDEND YIELD

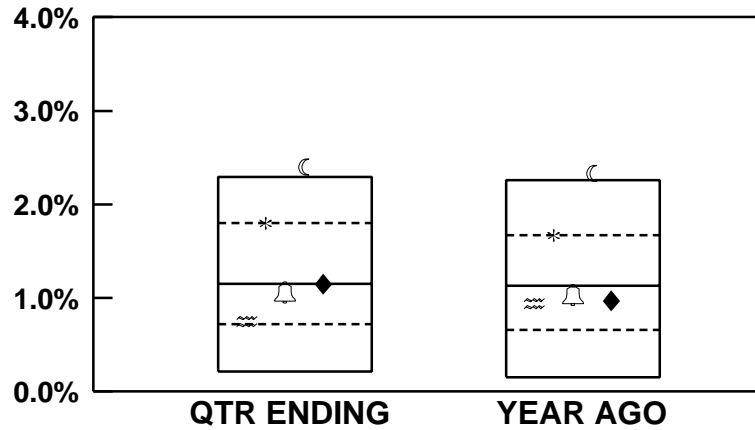

CAPITALIZATION

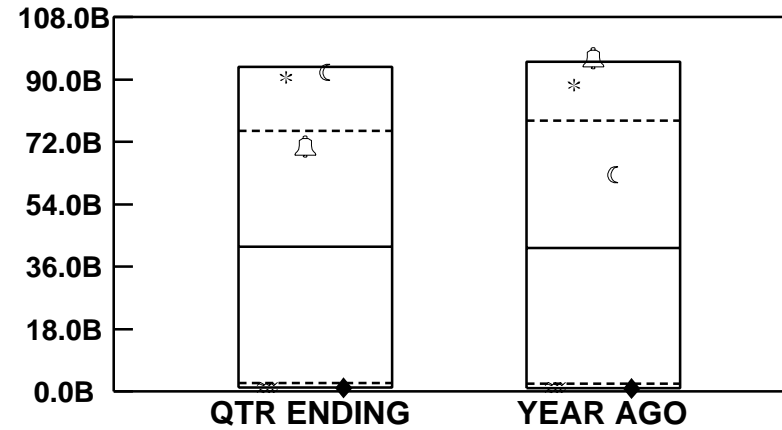

EFFECTS ON RETURN

- H
- MH
- ML
- L

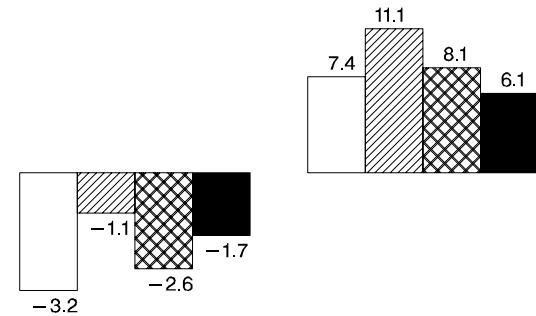
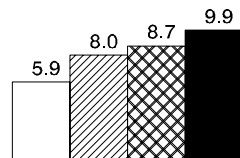
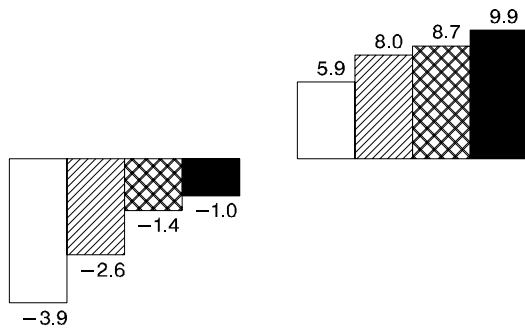

	QTR ENDING	YEAR AGO	QTR ENDING	YEAR AGO
LAZARD	0.75	71	0.94	59
S&P 500	1.80	26	1.67	21
R 1000(R) GR	1.06	53	1.03	54
R 1000(R) VALUE	2.40	2	2.33	3
R 2000(R)	1.15	50	0.97	57
MEDIAN	1.15	1.13	41.82	41.35

VERMONT MUNICIPAL EMPLOYEES

EQUITY PORTFOLIO CHARACTERISTICS

PERIODS ENDING 3/05

P/E RATIO

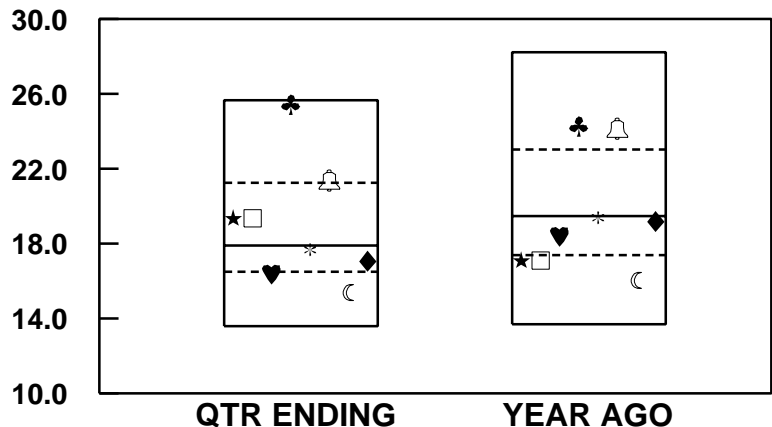

5YR EPS GROWTH

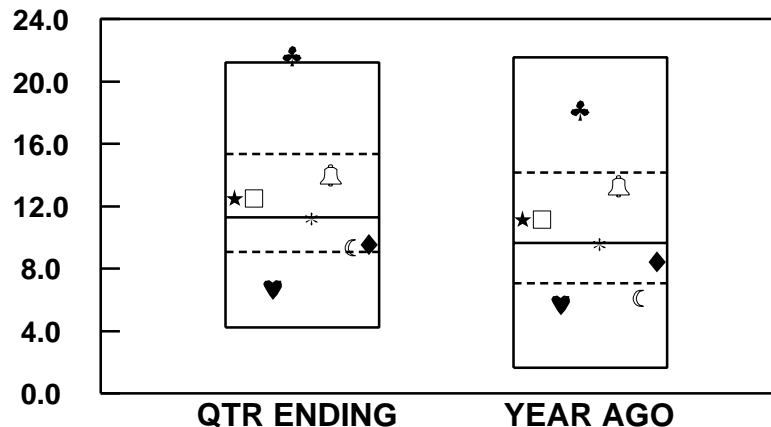

EFFECTS ON RETURN

- H
- MH
- ML
- L

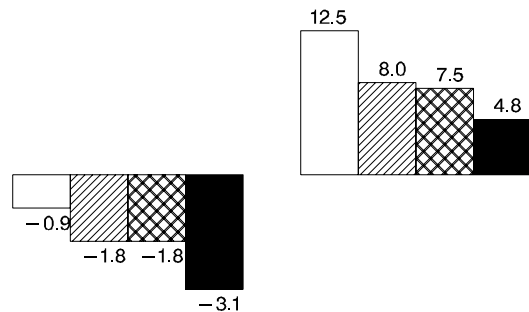
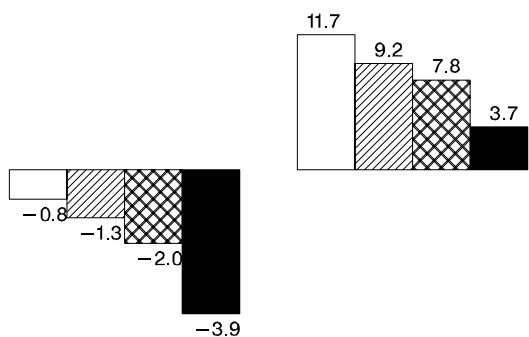

★ MUNI COMPOSITE	19.37	37	17.12	77	12.51	39	11.17	39
□ EQTY COMPOSITE	19.37	37	17.12	77	12.51	39	11.17	39
♥ DELAWARE	16.38	75	18.41	66	6.67	89	5.69	81
♣ ALLIANCE	25.46	5	24.30	19	21.68	4	18.19	11
* S&P 500	17.70	53	19.40	55	11.21	50	9.58	50
🔔 R 1000(R) GR	21.40	23	24.15	20	13.99	31	13.31	29
☾ R 1000(R) VALUE	15.39	81	16.06	84	9.36	72	6.09	79
◆ R 2000(R)	17.08	68	19.21	58	9.57	70	8.46	68
MEDIAN	17.91		19.47		11.31		9.66	

VERMONT MUNICIPAL EMPLOYEES

EQUITY PORTFOLIO CHARACTERISTICS

PERIODS ENDING 3/05

P/E RATIO

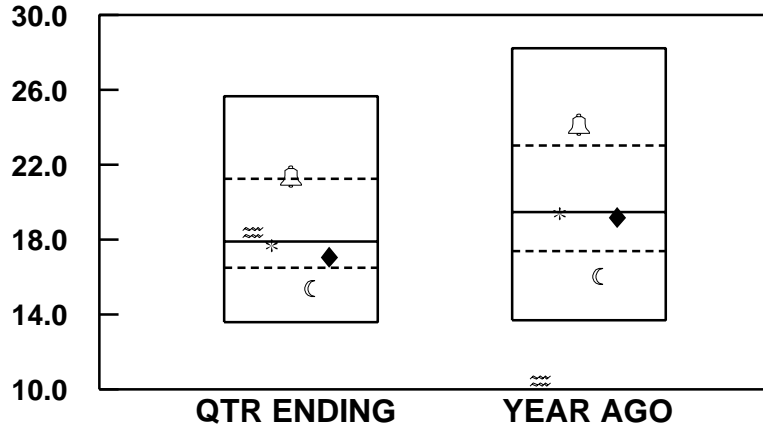

5YR EPS GROWTH

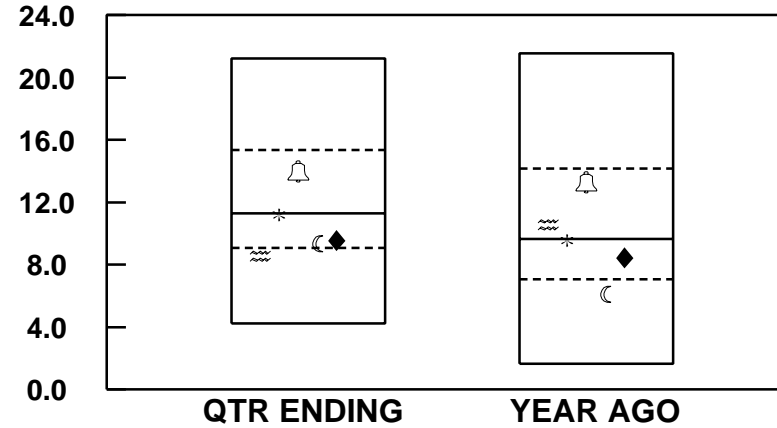

EFFECTS ON RETURN

- H
- MH
- ML
- L

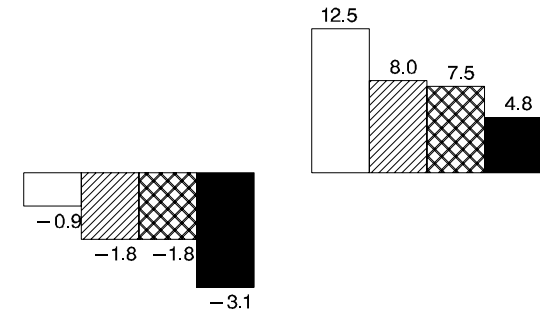
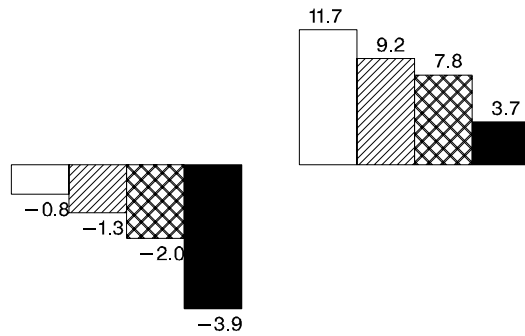

LAZARD	18.40	45	10.47	99	8.58	78	10.57	44
S&P 500	17.70	53	19.40	55	11.21	50	9.58	50
R 1000(R) GR	21.40	23	24.15	20	13.99	31	13.31	29
R 1000(R) VALUE	15.39	81	16.06	84	9.36	72	6.09	79
R 2000(R)	17.08	68	19.21	58	9.57	70	8.46	68
MEDIAN	17.91		19.47		11.31		9.66	

VERMONT MUNICIPAL EMPLOYEES

EQUITY PORTFOLIO CHARACTERISTICS

PERIODS ENDING 3/05

RETURN ON EQUITY

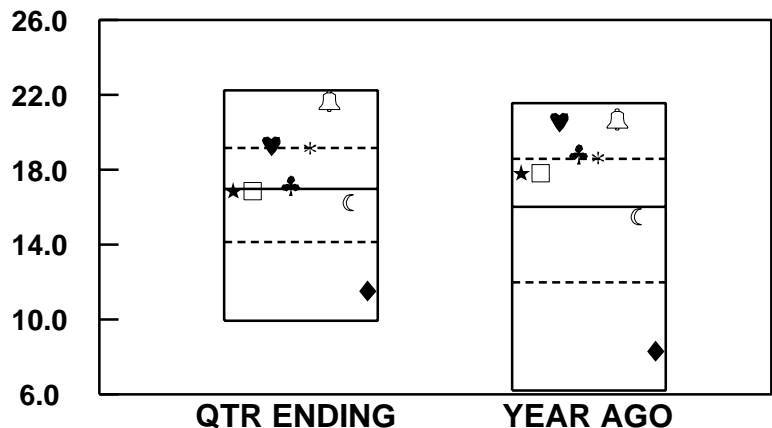

PRICE/BOOK

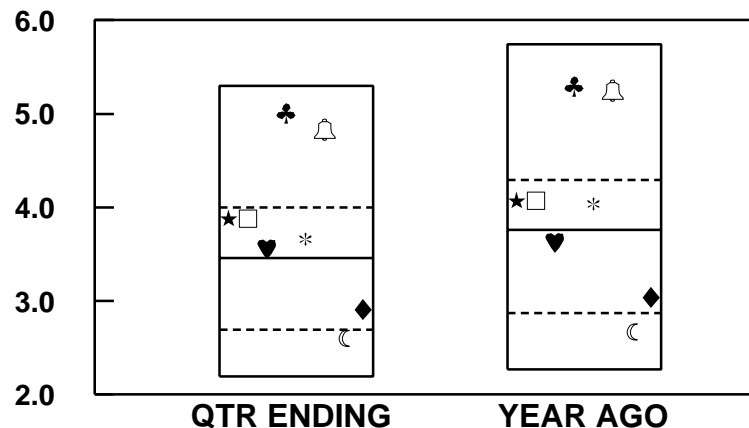

EFFECTS ON RETURN

- H
- MH
- ML
- L



★ MUNI COMPOSITE	16.87	51	17.84	33	3.88	29	4.07	31
□ EQTY COMPOSITE	16.87	51	17.84	33	3.88	29	4.07	31
♥ DELAWARE	19.32	22	20.58	7	3.56	46	3.63	52
♣ ALLIANCE	17.17	47	18.85	17	5.01	7	5.30	9
* S&P 500	19.18	24	18.64	19	3.66	36	4.04	40
🔔 R 1000(R) GR	21.70	6	20.69	7	4.83	9	5.25	10
☾ R 1000(R) VALUE	16.26	57	15.49	53	2.60	82	2.67	82
◆ R 2000(R)	11.53	90	8.33	90	2.91	66	3.04	69
MEDIAN	16.97		16.01		3.46		3.76	

VERMONT MUNICIPAL EMPLOYEES

EQUITY PORTFOLIO CHARACTERISTICS

PERIODS ENDING 3/05

RETURN ON EQUITY

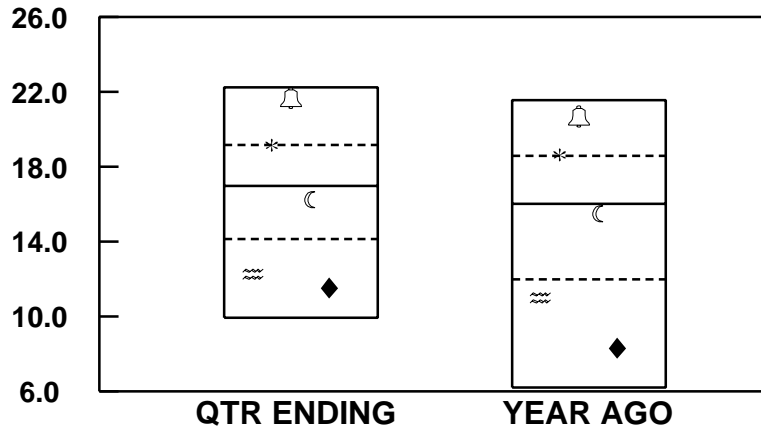

PRICE/BOOK

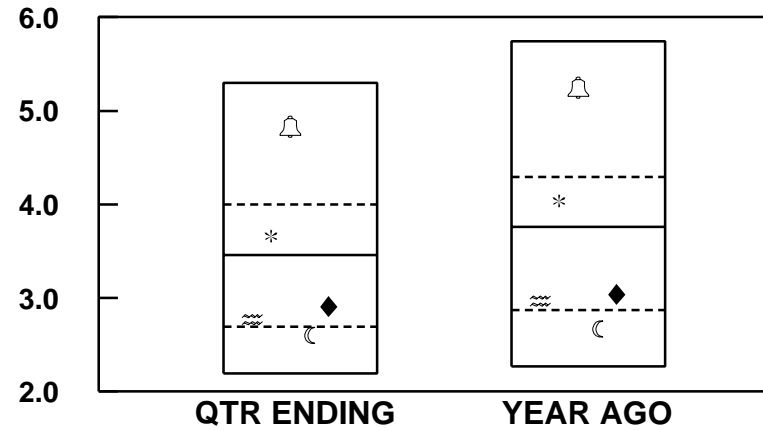

EFFECTS ON RETURN

- H
- MH
- ML
- L



≈ LAZARD	12.27	86	11.03	80	2.77	72	2.97	71
* S&P 500	19.18	24	18.64	19	3.66	36	4.04	40
🔔 R 1000(R) GR	21.70	6	20.69	7	4.83	9	5.25	10
☾ R 1000(R) VALUE	16.26	57	15.49	53	2.60	82	2.67	82
◆ R 2000(R)	11.53	90	8.33	90	2.91	66	3.04	69
MEDIAN	16.97		16.01		3.46		3.76	

VERMONT MUNICIPAL EMPLOYEES

EQUITY PORTFOLIO CHARACTERISTICS

PERIODS ENDING 3/05

PORTFOLIO BETA

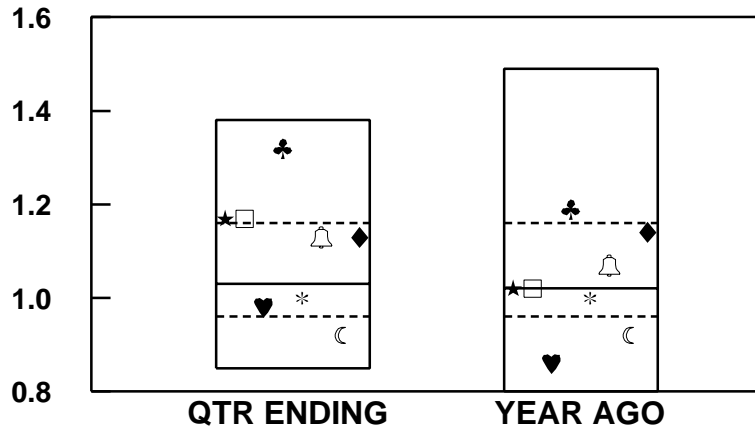

SIZE EXPOSURE

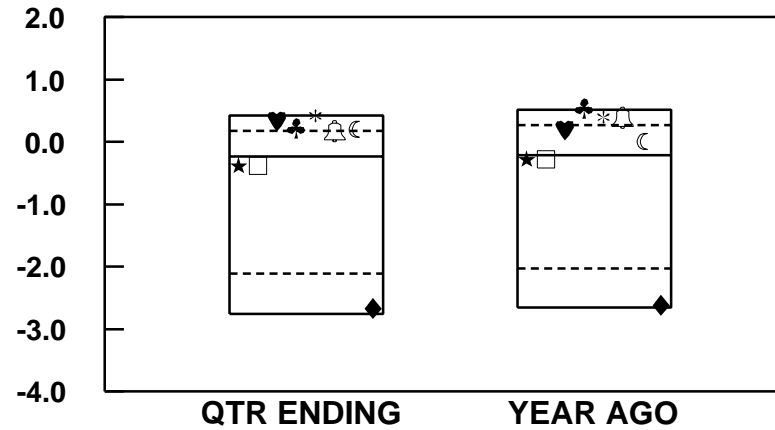

EFFECTS ON RETURN

- H
- MH
- ML
- L

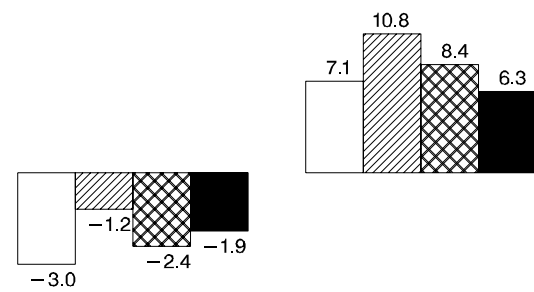
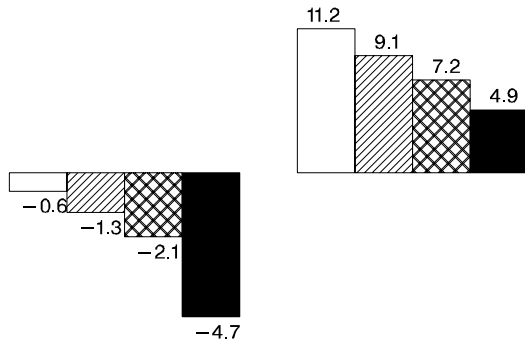

★ MUNI COMPOSITE	1.17	24	1.02	47
□ EQTY COMPOSITE	1.17	24	1.02	47
♥ DELAWARE	0.98	70	0.86	89
♣ ALLIANCE	1.32	8	1.19	21
* S&P 500	1.00	61	1.00	52
🔔 R 1000(R) GR	1.13	28	1.07	39
🌙 R 1000(R) VALUE	0.92	86	0.92	82
◆ R 2000(R)	1.13	27	1.14	27

	-0.38	53	-0.28	52
	-0.38	53	-0.28	52
	0.34	16	0.20	29
	0.23	21	0.55	4
	0.42	9	0.40	9
	0.18	24	0.39	18
	0.21	22	0.01	40
	-2.67	92	-2.62	94

MEDIAN 1.03 1.02 -0.23 -0.21

NEW ENGLAND PENSION CONSULTANTS

VERMONT MUNICIPAL EMPLOYEES

EQUITY PORTFOLIO CHARACTERISTICS

PERIODS ENDING 3/05

PORTFOLIO BETA

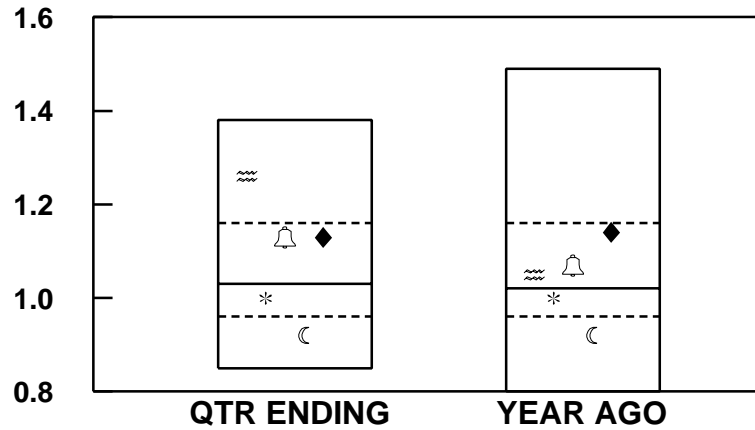

SIZE EXPOSURE

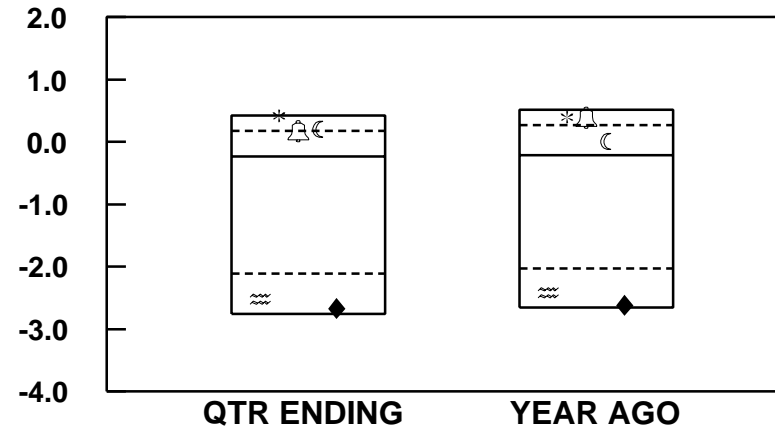

EFFECTS ON RETURN

- H
- MH
- ML
- L

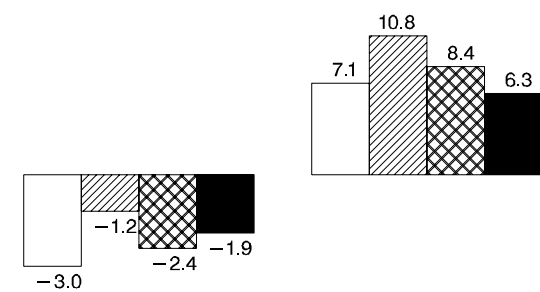
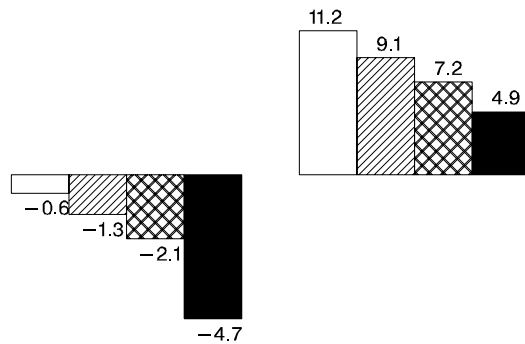

	QTR ENDING	YEAR AGO	QTR ENDING	YEAR AGO
LAZARD	1.26	1.05	-2.52	-2.41
S&P 500	1.00	1.00	0.42	0.40
R 1000(R) GR	1.13	1.07	0.18	0.39
R 1000(R) VALUE	0.92	0.92	0.21	0.01
R 2000(R)	1.13	1.14	-2.67	-2.62
MEDIAN	1.03	1.02	-0.23	-0.21

VERMONT MUNICIPAL EMPLOYEES

EQUITY PORTFOLIO CHARACTERISTICS

PERIODS ENDING 3/05

EQUITY R2

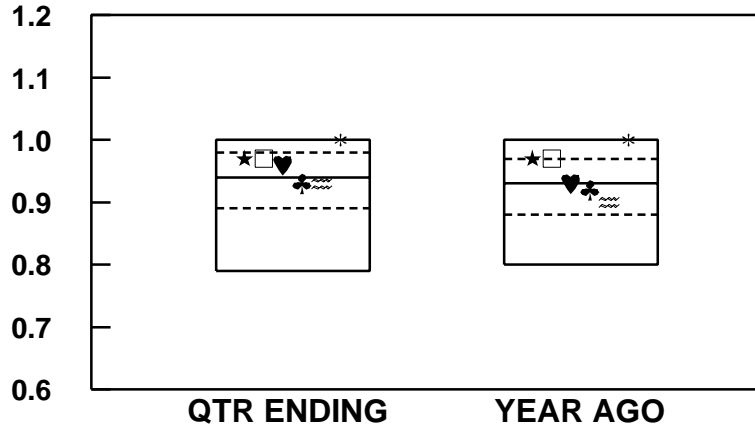

STANDARD ERROR

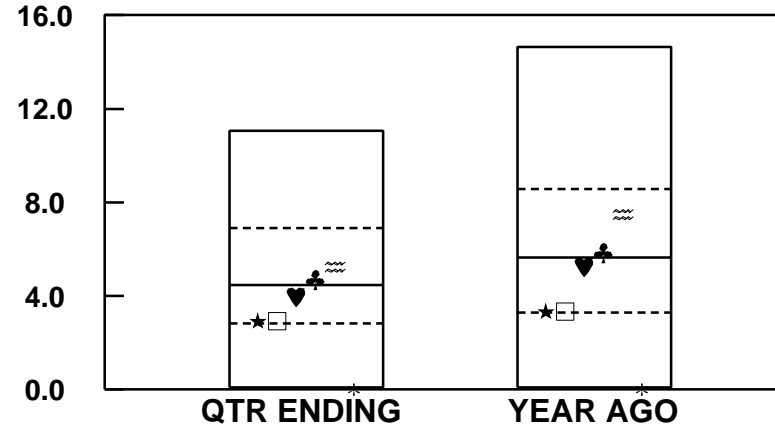

EFFECTS ON RETURN

- H
- MH
- ML
- L



★ MUNI COMPOSITE	0.97	27	0.97	24	2.93	73	3.34	74
□ EQTY COMPOSITE	0.97	27	0.97	24	2.93	73	3.34	74
♥ DELAWARE	0.96	40	0.93	49	3.98	59	5.26	53
♣ ALLIANCE	0.93	61	0.92	60	4.70	46	5.86	47
≈ LAZARD	0.93	57	0.90	66	5.25	40	7.49	33
* S&P 500	1.00	1	1.00	1	0.00		0.00	
MEDIAN	0.94		0.93		4.46		5.63	

VERMONT MUNICIPAL EMPLOYEES

EQUITY PORTFOLIO CHARACTERISTICS

PERIODS ENDING 3/05

FINANCIAL LEVERAGE

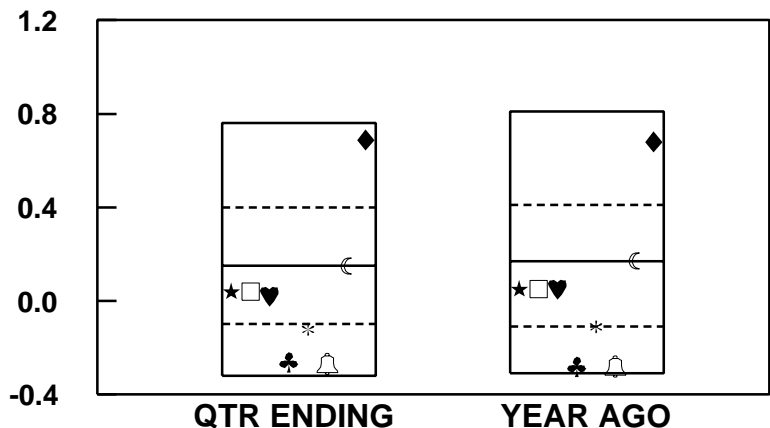

GROWTH EXPOSURE

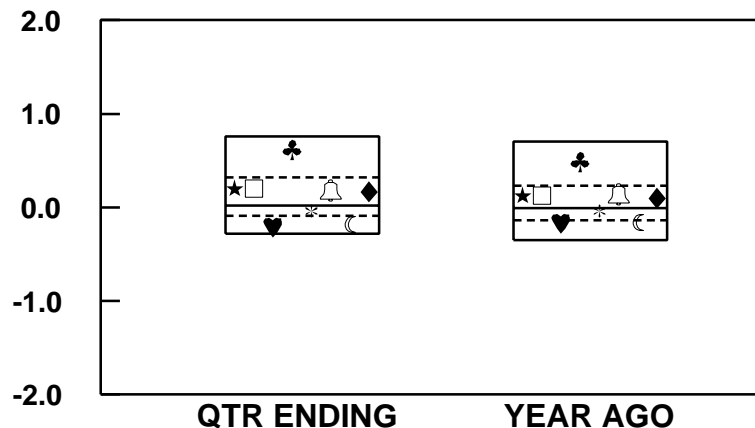

EFFECTS ON RETURN

- H
- MH
- ML
- L

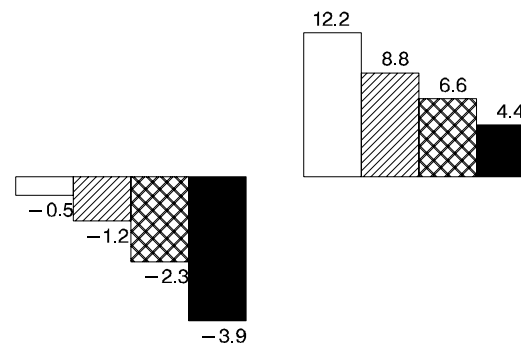
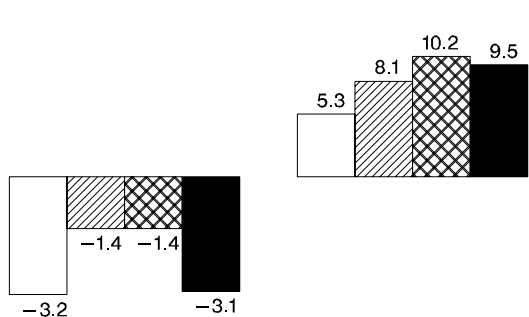

★ MUNI COMPOSITE	0.04	60	0.05	59	0.20	31	0.13	33
□ EQTY COMPOSITE	0.04	60	0.05	59	0.20	31	0.13	33
♥ DELAWARE	0.02	63	0.05	59	-0.21	89	-0.17	79
♣ ALLIANCE	-0.26	91	-0.28	91	0.62	9	0.49	11
* S&P 500	-0.12	82	-0.11	75	-0.04	60	-0.04	58
🔔 R 1000(R) GR	-0.27	91	-0.28	91	0.18	34	0.14	32
☾ R 1000(R) VALUE	0.15	50	0.17	51	-0.18	84	-0.16	76
◆ R 2000(R)	0.69	8	0.68	9	0.17	36	0.10	37
MEDIAN	0.15		0.17		0.02		-0.01	

VERMONT MUNICIPAL EMPLOYEES

EQUITY PORTFOLIO CHARACTERISTICS

PERIODS ENDING 3/05

FINANCIAL LEVERAGE

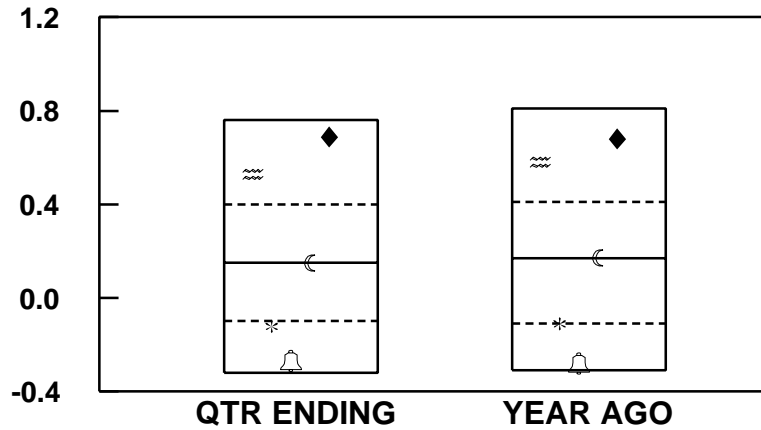

GROWTH EXPOSURE

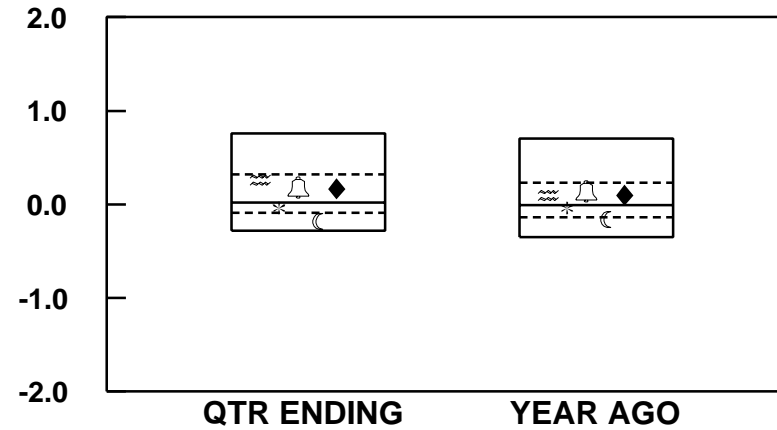

EFFECTS ON RETURN

- H
- MH
- ML
- L

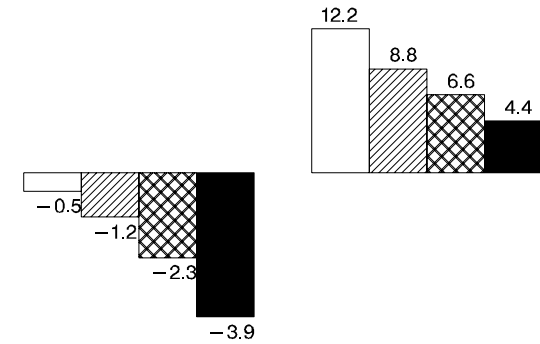
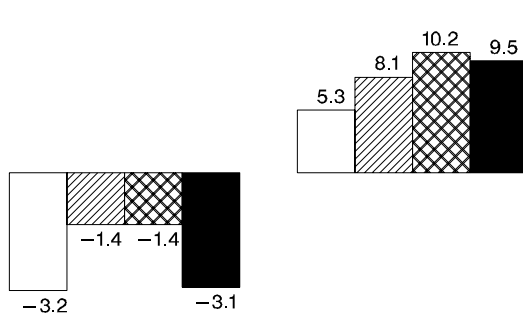

	QTR ENDING	YEAR AGO	QTR ENDING	YEAR AGO
≈ LAZARD	0.53	16	0.58	14
* S&P 500	-0.12	82	-0.11	75
🔔 R 1000(R) GR	-0.27	91	-0.28	91
☾ R 1000(R) VALUE	0.15	50	0.17	51
◆ R 2000(R)	0.69	8	0.68	9
MEDIAN	0.15	0.17	0.02	-0.01

VERMONT MUNICIPAL EMPLOYEES

DOMESTIC EQUITY ONLY PORTFOLIO CHARACTERISTICS

PERIODS ENDING 3/05

DIVIDEND YIELD

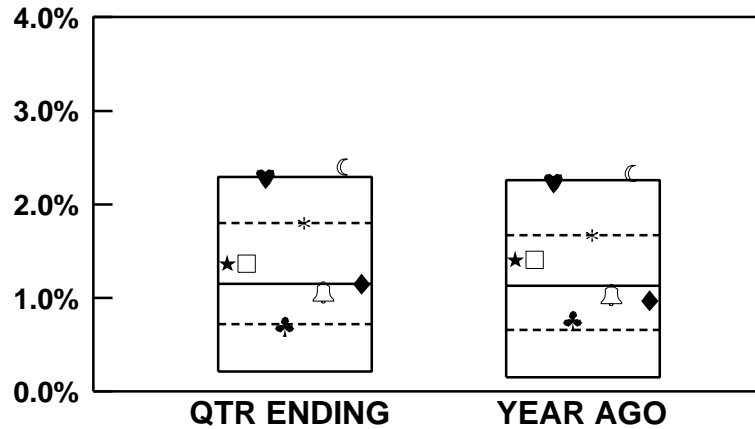

CAPITALIZATION

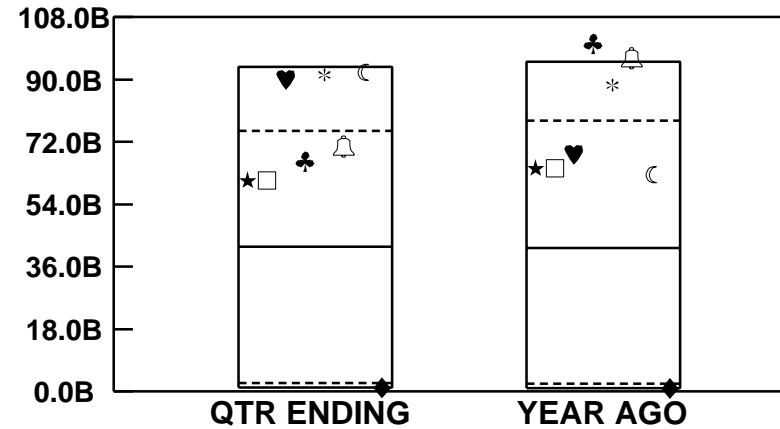

EFFECTS ON RETURN

- H
- MH
- ML
- L

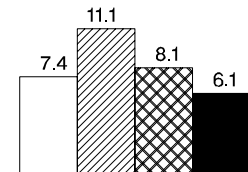
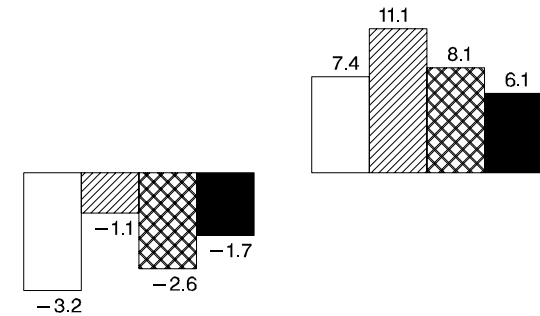
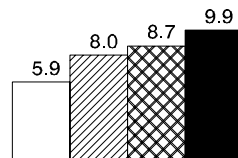
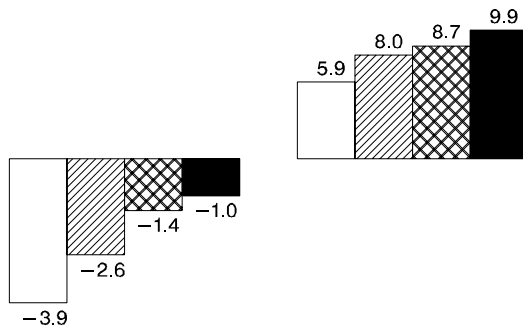

★ MUNI COMPOSITE	1.37	41	1.41	39	61.00	34	64.36	35
□ EQTY COMPOSITE	1.37	41	1.41	39	61.00	34	64.36	35
♥ DELAWARE	2.28	5	2.23	5	90.11	14	68.56	32
♣ ALLIANCE	0.70	75	0.76	70	66.46	30	100.45	3
* S&P 500	1.80	24	1.67	21	91.49	6	88.48	9
🔔 R 1000(R) GR	1.06	53	1.03	54	70.73	28	96.23	4
☾ R 1000(R) VALUE	2.40	2	2.33	3	92.09	5	62.66	36
◆ R 2000(R)	1.15	49	0.97	57	1.05	94	0.95	95
MEDIAN	1.15		1.13		41.82		41.35	

VERMONT MUNICIPAL EMPLOYEES

DOMESTIC EQUITY ONLY PORTFOLIO CHARACTERISTICS

PERIODS ENDING 3/05

DIVIDEND YIELD

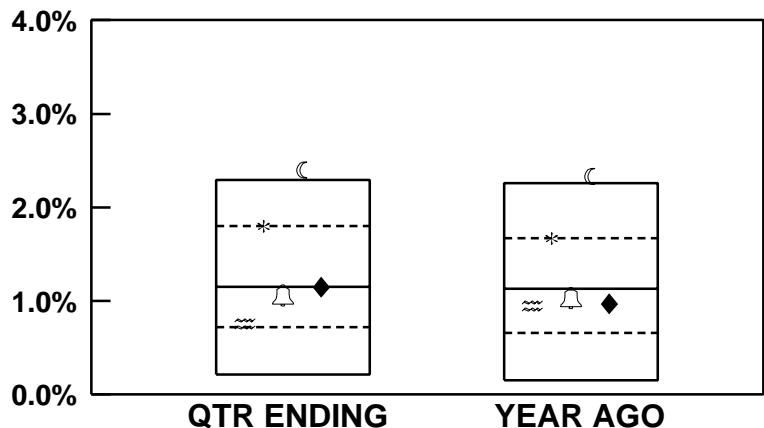

CAPITALIZATION

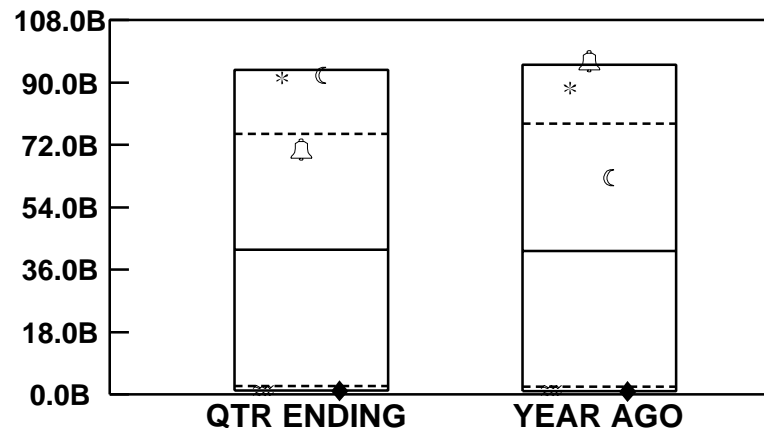

EFFECTS ON RETURN

- H
- MH
- ML
- L

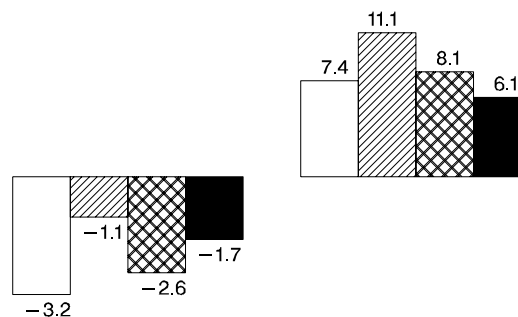
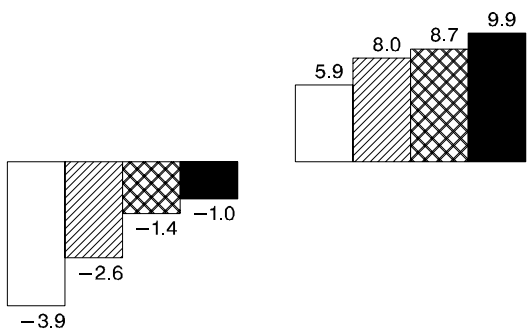

	QTR ENDING	YEAR AGO	QTR ENDING	YEAR AGO
≈ LAZARD	0.76	71	0.95	59
* S&P 500	1.80	24	1.67	21
🔔 R 1000(R) GR	1.06	53	1.03	54
☾ R 1000(R) VALUE	2.40	2	2.33	3
◆ R 2000(R)	1.15	49	0.97	57
MEDIAN	1.15	1.13	41.82	41.35

VERMONT MUNICIPAL EMPLOYEES

DOMESTIC EQUITY ONLY PORTFOLIO CHARACTERISTICS

PERIODS ENDING 3/05

P/E RATIO

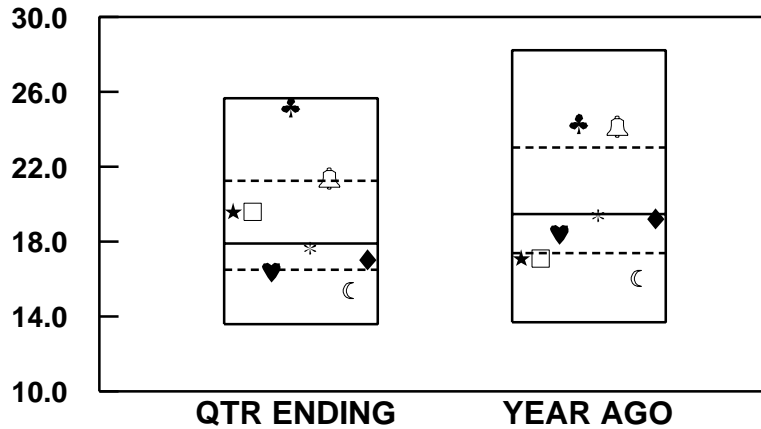

5YR EPS GROWTH

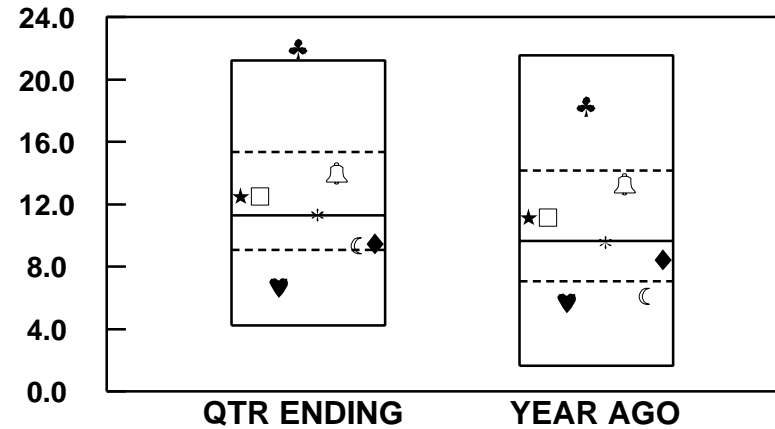

EFFECTS ON RETURN

- H
- MH
- ML
- L

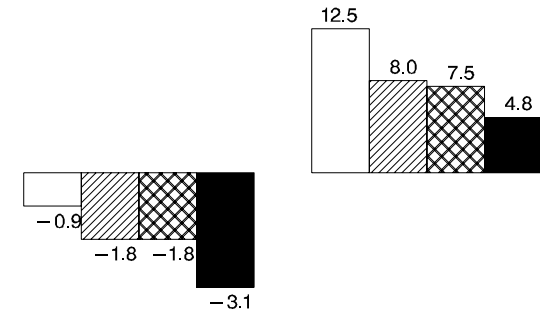
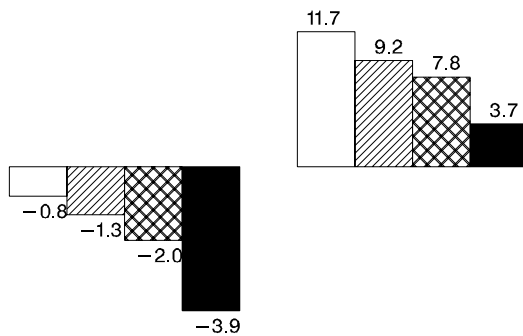

★ MUNI COMPOSITE	19.61	34	17.10	77	12.52	39	11.16	39
□ EQTY COMPOSITE	19.61	34	17.10	77	12.52	39	11.16	39
♥ DELAWARE	16.38	75	18.41	66	6.67	89	5.69	81
♣ ALLIANCE	25.22	6	24.34	19	21.99	4	18.29	11
* S&P 500	17.66	60	19.40	55	11.31	50	9.58	50
🔔 R 1000(R) GR	21.40	23	24.15	20	13.98	31	13.31	29
☾ R 1000(R) VALUE	15.39	81	16.06	84	9.35	72	6.09	79
◆ R 2000(R)	17.06	68	19.22	58	9.48	71	8.46	68
MEDIAN	17.91		19.47		11.31		9.66	

VERMONT MUNICIPAL EMPLOYEES

DOMESTIC EQUITY ONLY PORTFOLIO CHARACTERISTICS

PERIODS ENDING 3/05

P/E RATIO

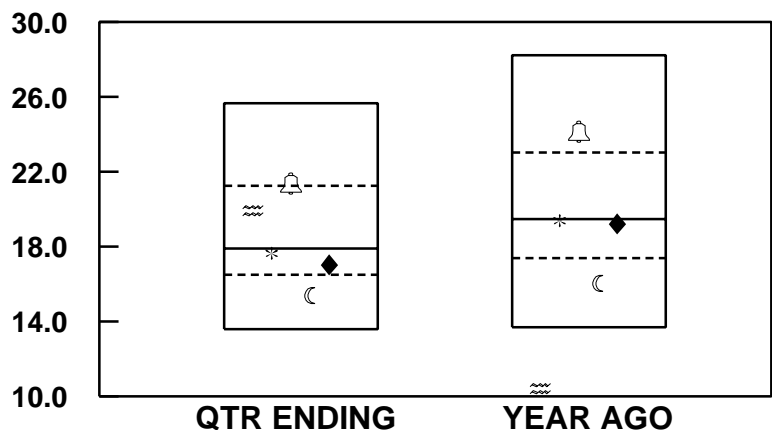

5YR EPS GROWTH

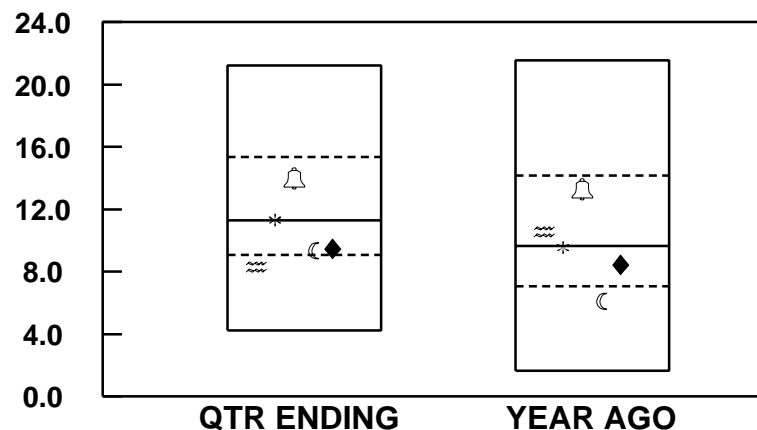

EFFECTS ON RETURN

- H
- MH
- ML
- L

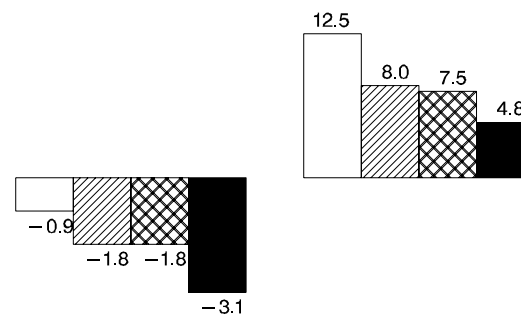
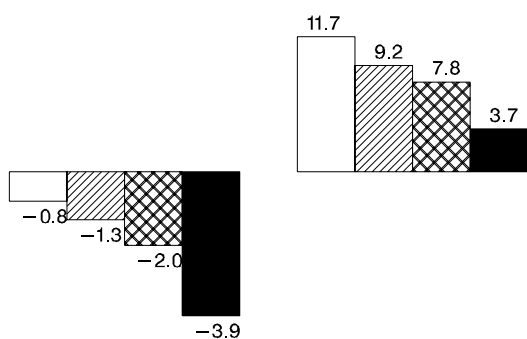

≈ LAZARD	19.93	32	10.43	99	8.33	80	10.57	44
* S&P 500	17.66	60	19.40	55	11.31	50	9.58	50
🔔 R 1000(R) GR	21.40	23	24.15	20	13.98	31	13.31	29
☾ R 1000(R) VALUE	15.39	81	16.06	84	9.35	72	6.09	79
◆ R 2000(R)	17.06	68	19.22	58	9.48	71	8.46	68
MEDIAN	17.91		19.47		11.31		9.66	

VERMONT MUNICIPAL EMPLOYEES

DOMESTIC EQUITY ONLY PORTFOLIO CHARACTERISTICS

PERIODS ENDING 3/05

RETURN ON EQUITY

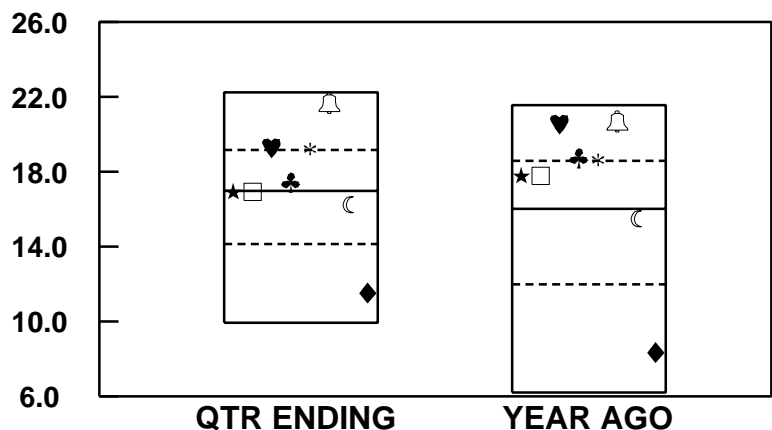

PRICE/BOOK

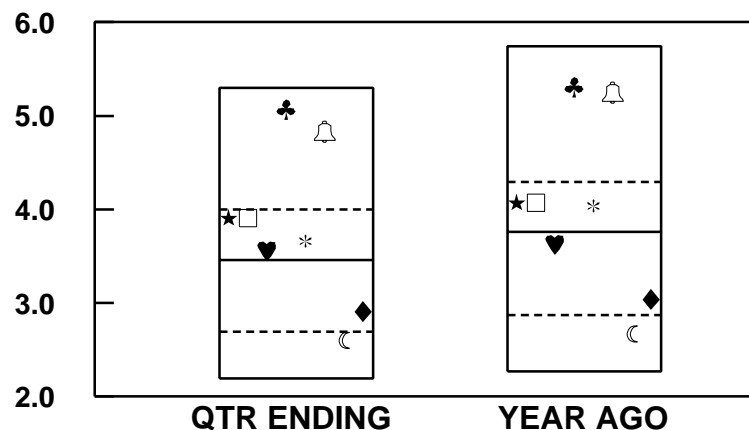

EFFECTS ON RETURN

- H
- MH
- ML
- L

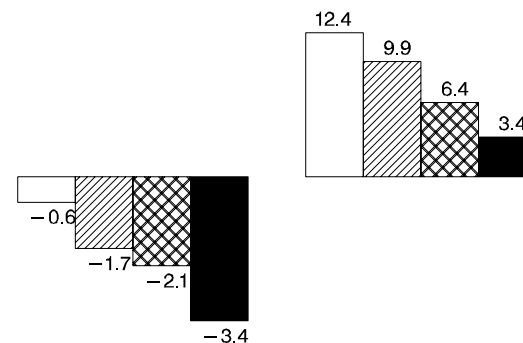
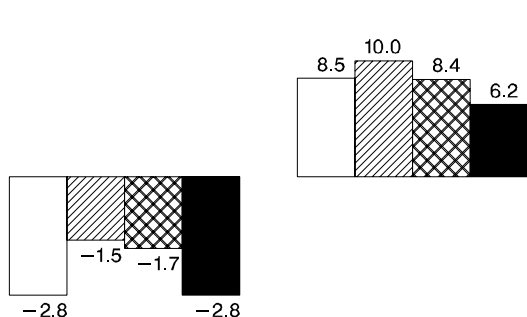

★ MUNI COMPOSITE	16.94	50	17.81	34	3.91	28	4.07	31
□ EQTY COMPOSITE	16.94	50	17.81	34	3.91	28	4.07	31
♥ DELAWARE	19.32	22	20.58	7	3.56	46	3.63	52
♣ ALLIANCE	17.47	44	18.75	18	5.07	7	5.31	9
* S&P 500	19.25	23	18.64	19	3.66	37	4.04	40
🔔 R 1000(R) GR	21.70	6	20.69	7	4.83	9	5.25	10
☾ R 1000(R) VALUE	16.25	57	15.49	53	2.60	82	2.67	82
◆ R 2000(R)	11.54	90	8.36	90	2.91	66	3.04	69
MEDIAN	16.97		16.01		3.46		3.76	

VERMONT MUNICIPAL EMPLOYEES

DOMESTIC EQUITY ONLY PORTFOLIO CHARACTERISTICS

PERIODS ENDING 3/05

RETURN ON EQUITY

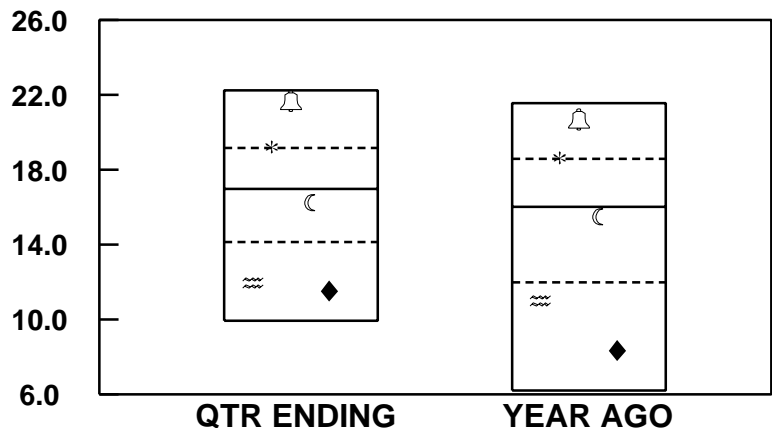

PRICE/BOOK

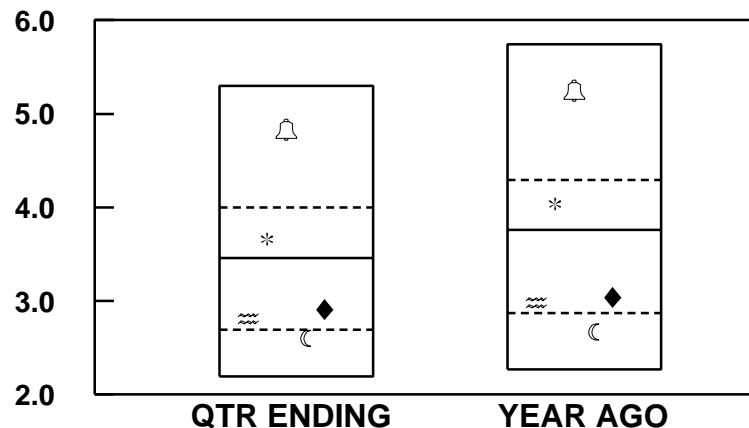

EFFECTS ON RETURN

- H
- MH
- ML
- L



≈ LAZARD	11.97	87	11.00	80	2.81	71	2.98	71
* S&P 500	19.25	23	18.64	19	3.66	37	4.04	40
🔔 R 1000(R) GR	21.70	6	20.69	7	4.83	9	5.25	10
☾ R 1000(R) VALUE	16.25	57	15.49	53	2.60	82	2.67	82
◆ R 2000(R)	11.54	90	8.36	90	2.91	66	3.04	69
MEDIAN	16.97		16.01		3.46		3.76	

VERMONT MUNICIPAL EMPLOYEES

DOMESTIC EQUITY ONLY PORTFOLIO CHARACTERISTICS

PERIODS ENDING 3/05

PORTFOLIO BETA

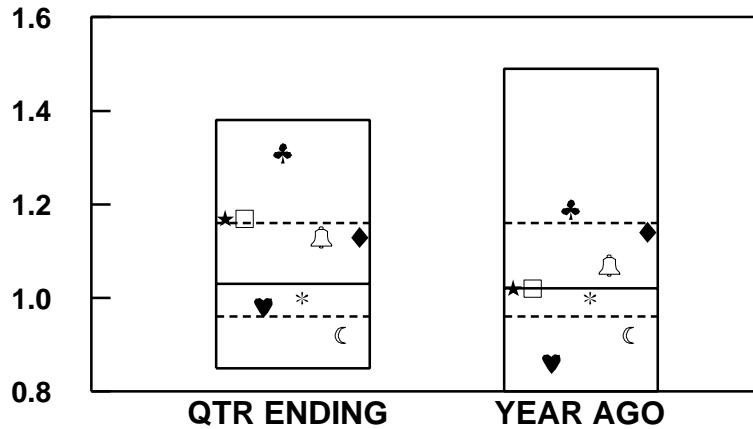

SIZE EXPOSURE

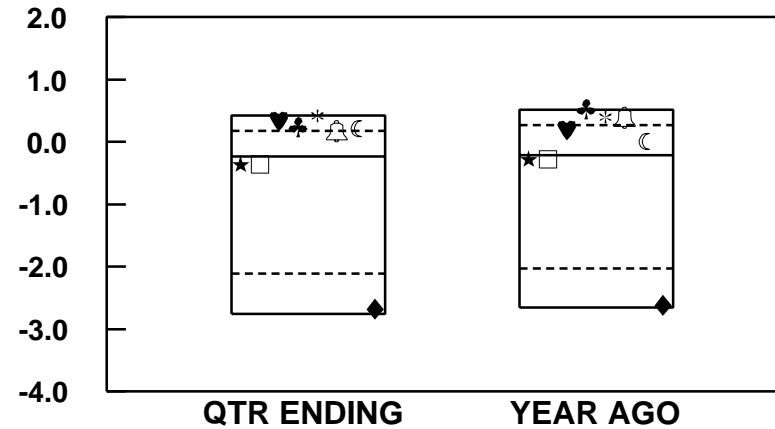

EFFECTS ON RETURN

- H
- MH
- ML
- L

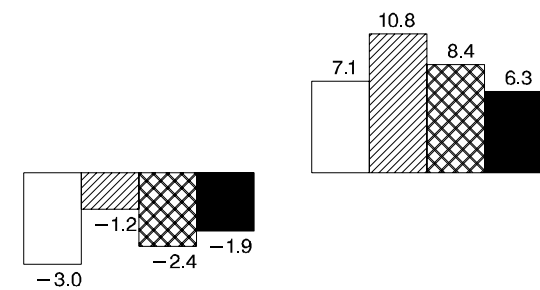
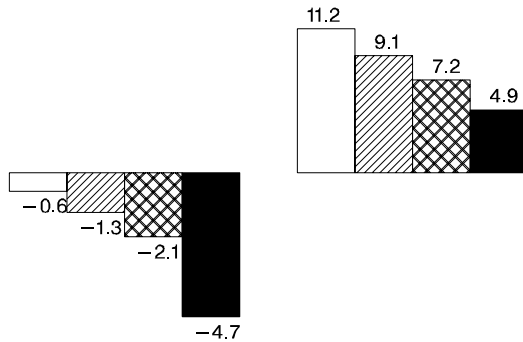

★ MUNI COMPOSITE	1.17	24	1.02	50
□ EQTY COMPOSITE	1.17	24	1.02	50
♥ DELAWARE	0.98	70	0.86	89
♣ ALLIANCE	1.31	8	1.19	22
* S&P 500	1.00	61	1.00	52
🔔 R 1000(R) GR	1.13	28	1.07	39
🌙 R 1000(R) VALUE	0.92	86	0.92	82
◆ R 2000(R)	1.13	27	1.14	27

	-0.36	53	-0.28	52
	-0.36	53	-0.28	52
	0.34	16	0.20	29
	0.25	20	0.54	4
	0.42	4	0.40	9
	0.18	24	0.39	18
	0.22	22	0.01	40
	-2.68	92	-2.62	94

MEDIAN 1.03 1.02 -0.23 -0.21
NEW ENGLAND PENSION CONSULTANTS

VERMONT MUNICIPAL EMPLOYEES

DOMESTIC EQUITY ONLY PORTFOLIO CHARACTERISTICS

PERIODS ENDING 3/05

PORTFOLIO BETA

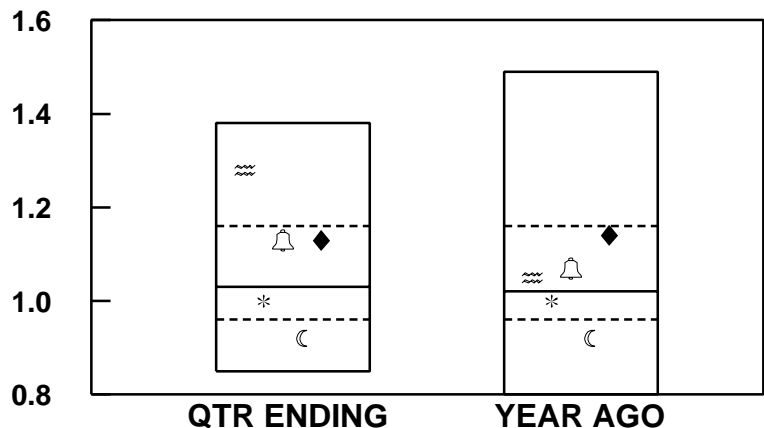

SIZE EXPOSURE

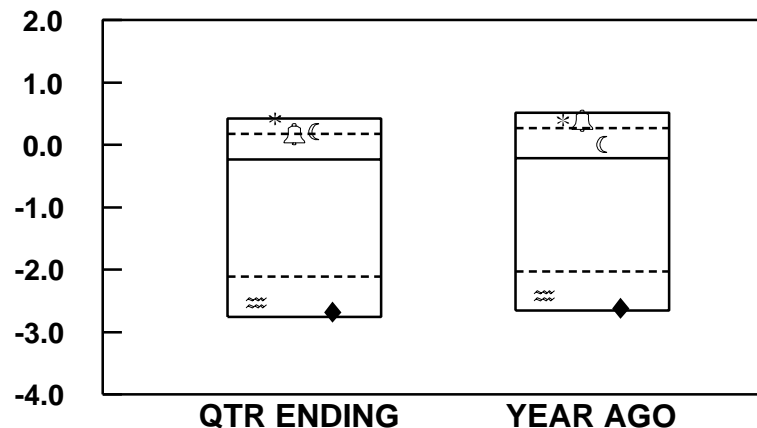

EFFECTS ON RETURN

- H
- MH
- ML
- L

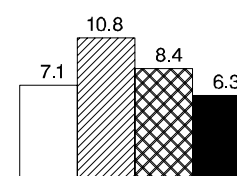
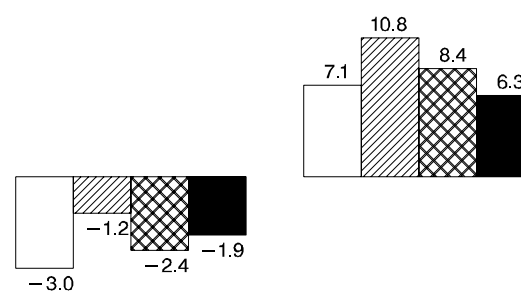
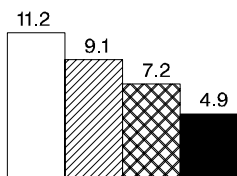
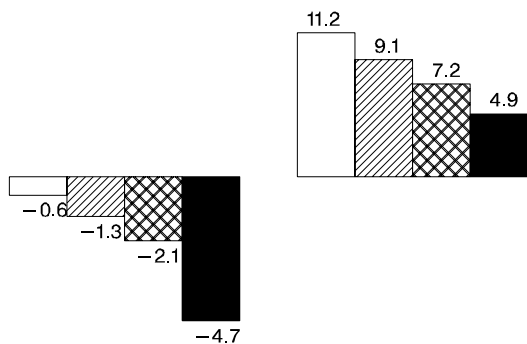

LAZARD	1.28	12	1.05	42	-2.53	86	-2.41	86
S&P 500	1.00	61	1.00	52	0.42	4	0.40	9
R 1000(R) GR	1.13	28	1.07	39	0.18	24	0.39	18
R 1000(R) VALUE	0.92	86	0.92	82	0.22	22	0.01	40
R 2000(R)	1.13	27	1.14	27	-2.68	92	-2.62	94
MEDIAN	1.03		1.02		-0.23		-0.21	

VERMONT MUNICIPAL EMPLOYEES

DOMESTIC EQUITY ONLY PORTFOLIO CHARACTERISTICS

PERIODS ENDING 3/05

EQUITY R2

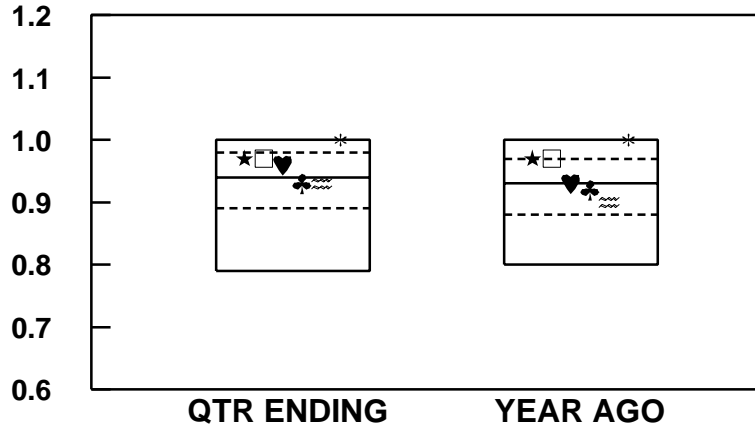

STANDARD ERROR

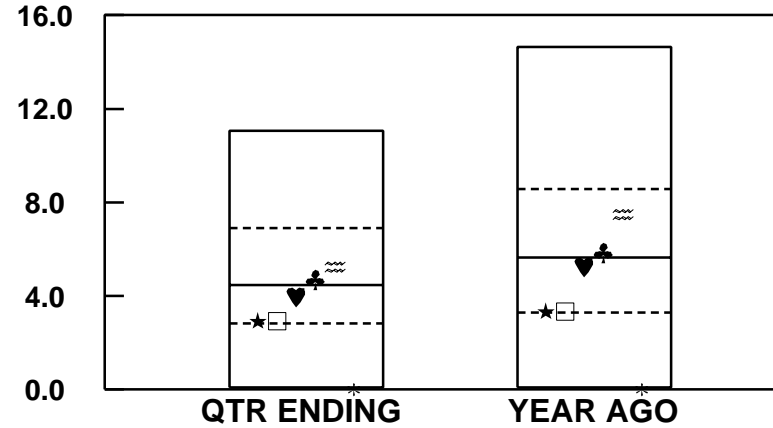

EFFECTS ON RETURN

- H
- MH
- ML
- L



★ MUNI COMPOSITE	0.97	27	0.97	24	2.93	73	3.34	74
□ EQTY COMPOSITE	0.97	27	0.97	24	2.93	73	3.34	74
♥ DELAWARE	0.96	40	0.93	49	3.98	59	5.26	53
♣ ALLIANCE	0.93	61	0.92	60	4.70	46	5.86	47
≈ LAZARD	0.93	57	0.90	66	5.25	40	7.49	33
* S&P 500	1.00	1	1.00	1	0.00		0.00	
MEDIAN	0.94		0.93		4.46		5.63	

VERMONT MUNICIPAL EMPLOYEES

DOMESTIC EQUITY ONLY PORTFOLIO CHARACTERISTICS

PERIODS ENDING 3/05

FINANCIAL LEVERAGE

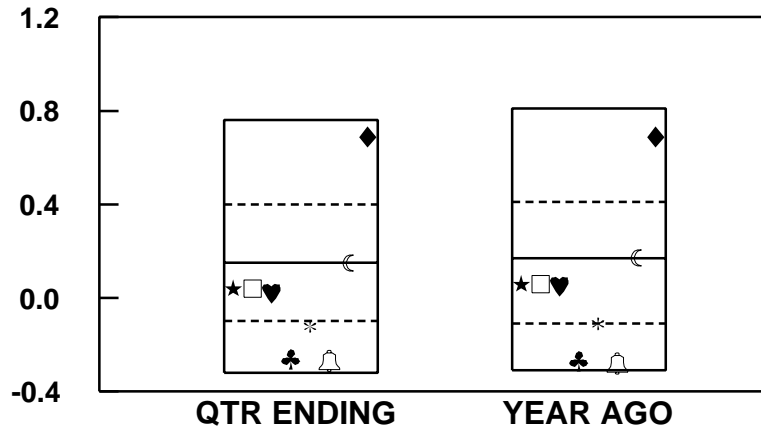

GROWTH EXPOSURE

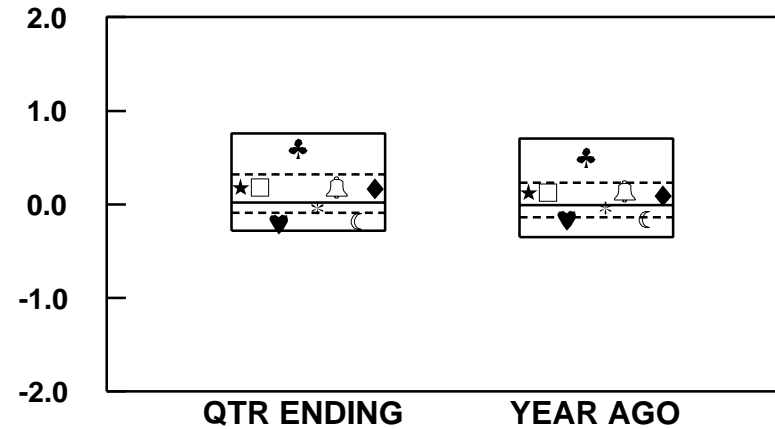

EFFECTS ON RETURN

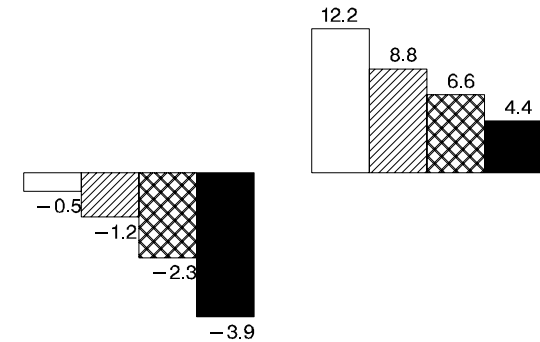
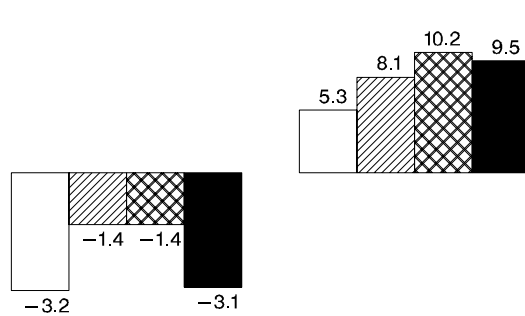
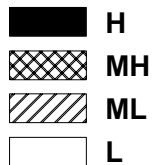

★ MUNI COMPOSITE	0.04	60	0.06	59
□ EQTY COMPOSITE	0.04	60	0.06	59
♥ DELAWARE	0.02	63	0.05	59
♣ ALLIANCE	-0.26	91	-0.27	91
* S&P 500	-0.12	76	-0.11	75
🔔 R 1000(R) GR	-0.27	91	-0.28	91
☾ R 1000(R) VALUE	0.15	50	0.17	51
◆ R 2000(R)	0.69	8	0.69	9

	0.18	34	0.13	34
	0.18	34	0.13	34
	-0.21	89	-0.17	79
	0.60	9	0.50	11
	-0.04	60	-0.04	58
	0.18	35	0.14	32
	-0.18	84	-0.16	76
	0.17	35	0.09	37

VERMONT MUNICIPAL EMPLOYEES

DOMESTIC EQUITY ONLY PORTFOLIO CHARACTERISTICS

PERIODS ENDING 3/05

FINANCIAL LEVERAGE

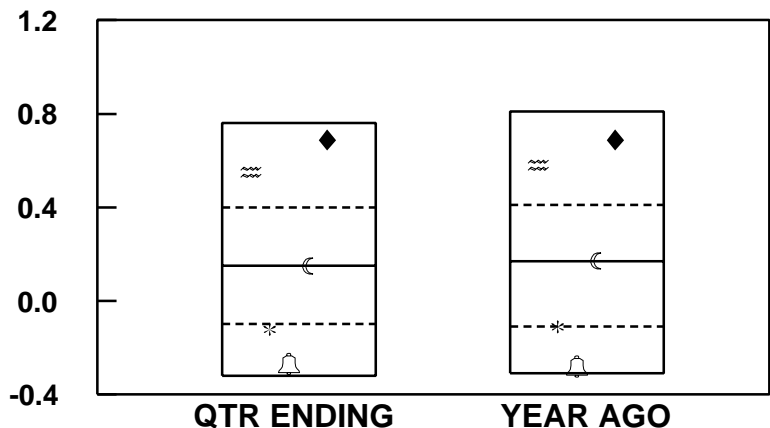

GROWTH EXPOSURE

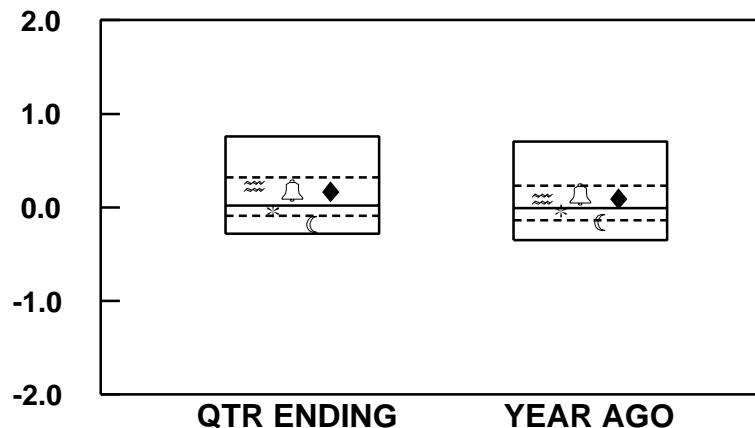

EFFECTS ON RETURN

- H
- MH
- ML
- L

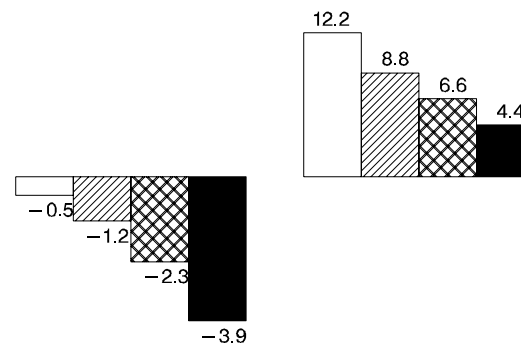
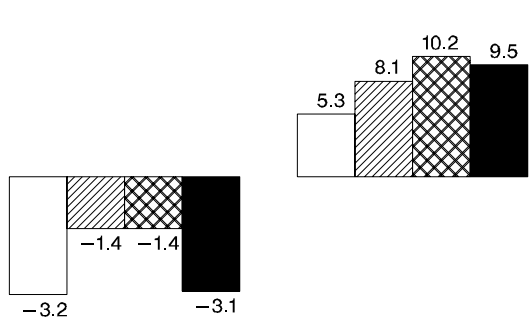

	QTR ENDING	YEAR AGO	QTR ENDING	YEAR AGO
≈ LAZARD	0.55	14	0.58	14
* S&P 500	-0.12	76	-0.11	75
🔔 R 1000(R) GR	-0.27	91	-0.28	91
☾ R 1000(R) VALUE	0.15	50	0.17	51
◆ R 2000(R)	0.69	8	0.69	9
MEDIAN	0.15	0.17	0.02	-0.01

VERMONT MUNICIPAL EMPLOYEES

DIVERSIFICATION BY INDUSTRY SECTOR

QUARTER ENDING 3/05

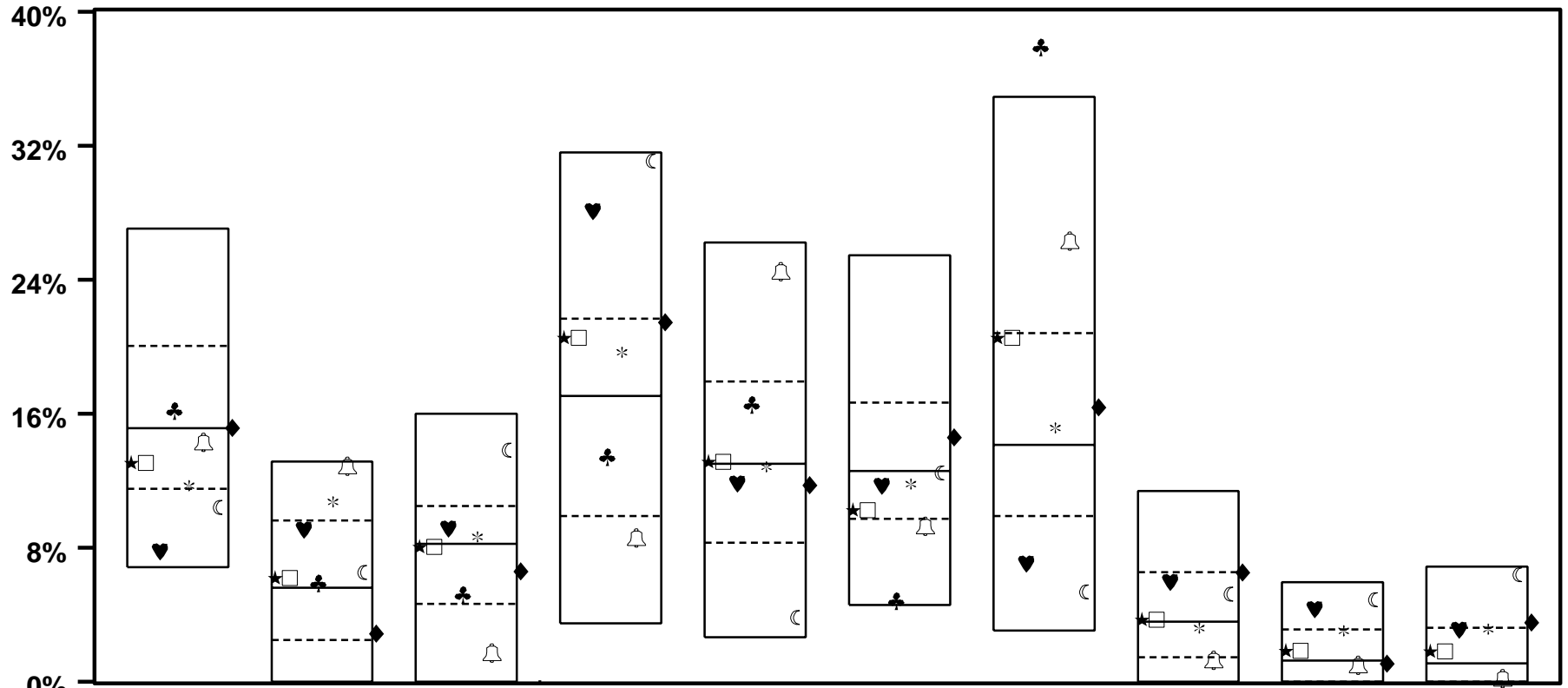

	CONSUMER DISCR		CONSUMER STAPLES		EN-ERGY		FINAN-CIALS		HEALTH CARE		INDUST-RIALS		INFO TECH		MATER-IALS		TELECOM SERVICES		UTIL-ITIES	
★ MUNI COMPOSITE	13.1	62	6.2	45	8.0	52	20.5	28	13.1	45	10.2	72	20.5	26	3.7	48	1.9	44	1.8	44
□ EQTY COMPOSITE	13.1	62	6.2	45	8.0	52	20.5	28	13.1	45	10.2	72	20.5	26	3.7	48	1.9	44	1.8	44
♥ DELAWARE	7.8	92	9.1	28	9.1	35	28.1	10	11.8	58	11.7	63	7.1	85	6.0	27	4.4	12	3.1	34
♣ ALLIANCE	16.2	42	5.9	48	5.2	71	13.4	62	16.5	28	4.8	94	37.9	3						
* S&P 500	11.7	71	10.8	13	8.7	45	19.7	37	12.8	53	11.8	62	15.2	42	3.2	60	3.1	30	3.1	34
🔔 R 1000(R) GR	14.3	54	12.9	5	1.7	87	8.6	80	24.5	7	9.3	77	26.3	14	1.3	76	1.0	55	0.2	55
☾ R 1000(R) VALUE	10.4	84	6.5	43	13.8	10	31.1	5	3.9	90	12.5	50	5.4	90	5.2	33	4.9	8	6.4	6
◆ R 2000(R)	15.2	49	2.9	71	6.6	62	21.5	25	11.8	59	14.6	37	16.4	37	6.5	24	1.1	53	3.6	20
MEDIAN	15.1		5.6		8.2		17.0		13.0		12.6		14.2		3.6		1.3		1.1	

VERMONT MUNICIPAL EMPLOYEES

DIVERSIFICATION BY INDUSTRY SECTOR

QUARTER ENDING 3/05

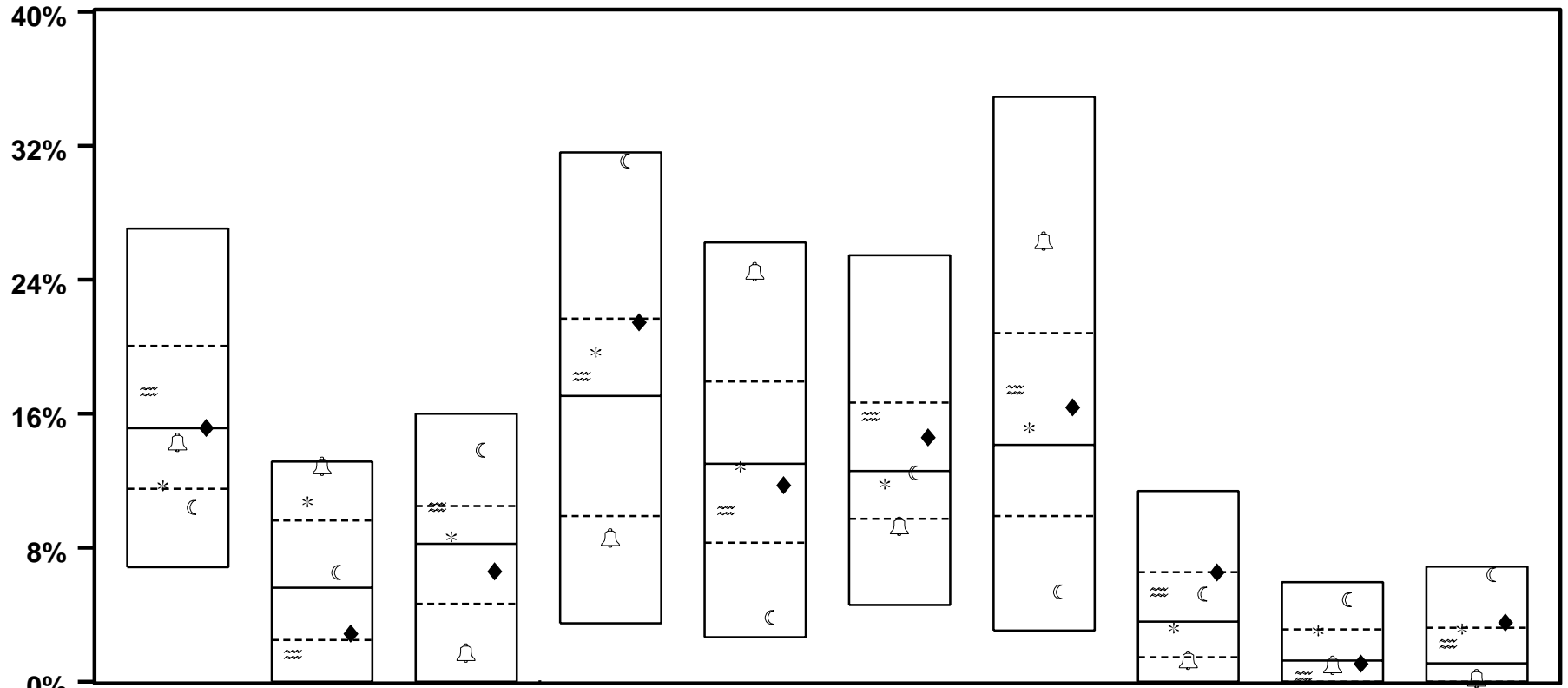

	CONSUMER DISCR		CONSUMER STAPLES		EN-ERGY		FINAN-CIALS		HEALTH CARE		INDUST-RIALS		INFO TECH		MATER-IALS		TELECOM SERVICES		UTIL-ITIES	
≈ LAZARD	17.4	36	1.7	83	10.4	25	18.3	43	10.3	68	15.8	30	17.4	34	5.4	32	0.4	63	2.3	42
* S&P 500	11.7	71	10.8	13	8.7	45	19.7	37	12.8	53	11.8	62	15.2	42	3.2	60	3.1	30	3.1	34
🔔 R 1000(R) GR	14.3	54	12.9	5	1.7	87	8.6	80	24.5	7	9.3	77	26.3	14	1.3	76	1.0	55	0.2	55
☾ R 1000(R) VALUE	10.4	84	6.5	43	13.8	10	31.1	5	3.9	90	12.5	50	5.4	90	5.2	33	4.9	8	6.4	6
◆ R 2000(R)	15.2	49	2.9	71	6.6	62	21.5	25	11.8	59	14.6	37	16.4	37	6.5	24	1.1	53	3.6	20
MEDIAN	15.1		5.6		8.2		17.0		13.0		12.6		14.2		3.6		1.3		1.1	

VERMONT MUNICIPAL EMPLOYEES

RATES OF RETURN BY INDUSTRY SECTOR

QUARTER ENDING 3/05

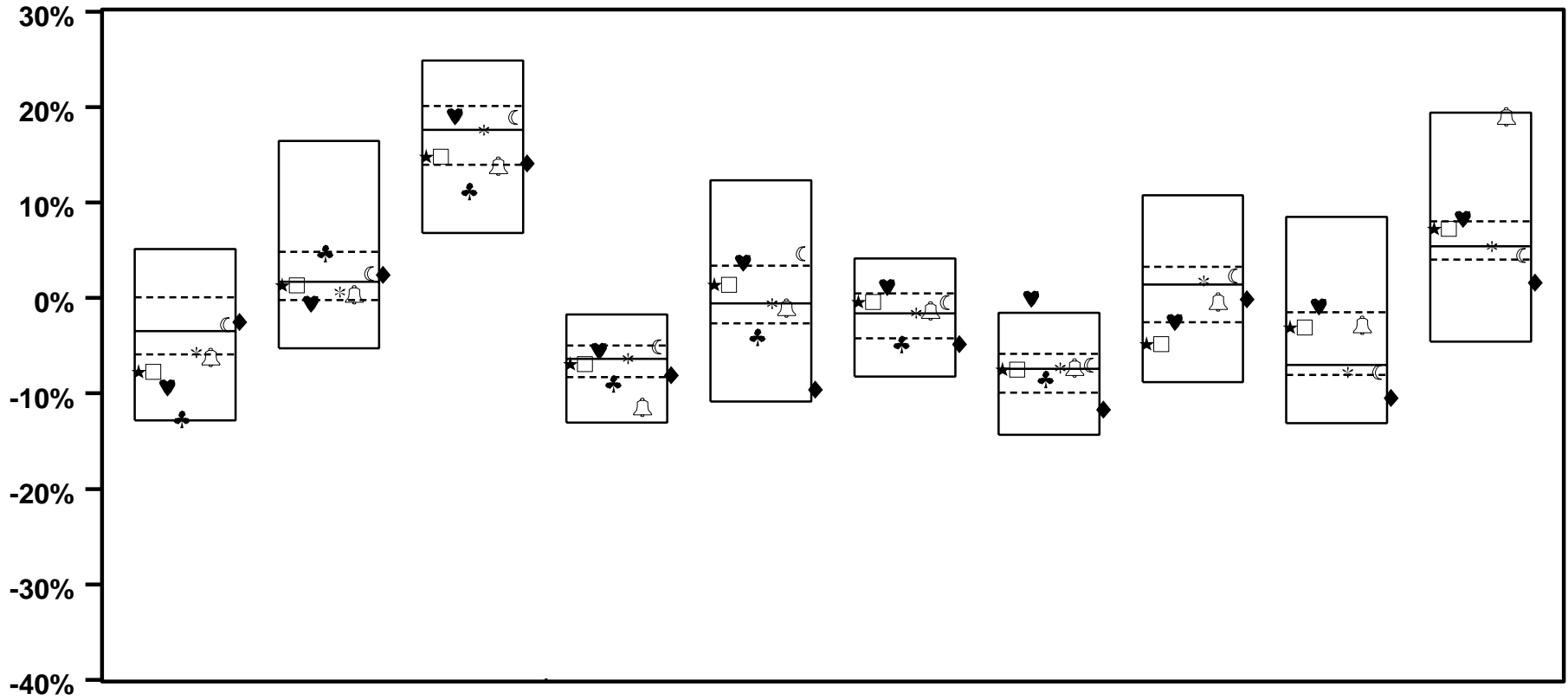

	CONSUMER DISCR		CONSUMER STAPLES		EN-ERGY		FINAN-CIALS		HEALTH CARE		INDUST-RIALS		INFO TECH		MATER-IALS		TELECOM SERVICES		UTIL-ITIES	
★ MUNI COMPOSITE	-7.7	82	1.3	53	14.8	69	-6.9	60	1.4	36	-0.4	31	-7.5	51	-4.8	83	-3.1	28	7.3	35
□ EQTY COMPOSITE	-7.7	82	1.3	53	14.8	69	-6.9	60	1.4	36	-0.4	31	-7.5	51	-4.8	83	-3.1	28	7.3	35
♥ DELAWARE	-9.3	87	-0.6	78	19.1	30	-5.5	33	3.7	21	1.1	17	0.0	3	-2.5	74	-0.9	21	8.3	22
♣ ALLIANCE	-12.7	94	4.7	26	11.2	87	-8.9	80	-4.0	81	-4.8	79	-8.5	63						
* S&P 500	-5.7	72	0.6	60	17.6	45	-6.4	46	-0.6	51	-1.6	49	-7.3	48	1.8	41	-7.8	66	5.4	56
🔔 R 1000(R) GR	-6.2	76	0.4	70	13.8	76	-11.4	91	-1.0	62	-1.3	41	-7.3	49	-0.4	63	-2.8	27	19.0	6
🌙 R 1000(R) VALUE	-2.8	43	2.6	40	18.9	31	-5.1	27	4.6	18	-0.5	32	-7.0	36	2.3	32	-7.8	66	4.5	72
◆ R 2000(R)	-2.5	41	2.4	45	14.1	73	-8.1	72	-9.6	94	-4.8	79	-11.7	87	-0.1	60	-10.5	92	1.6	84
MEDIAN	-3.5		1.7		17.6		-6.4		-0.6		-1.6		-7.4		1.4		-7.0		5.4	

VERMONT MUNICIPAL EMPLOYEES

RATES OF RETURN BY INDUSTRY SECTOR

QUARTER ENDING 3/05

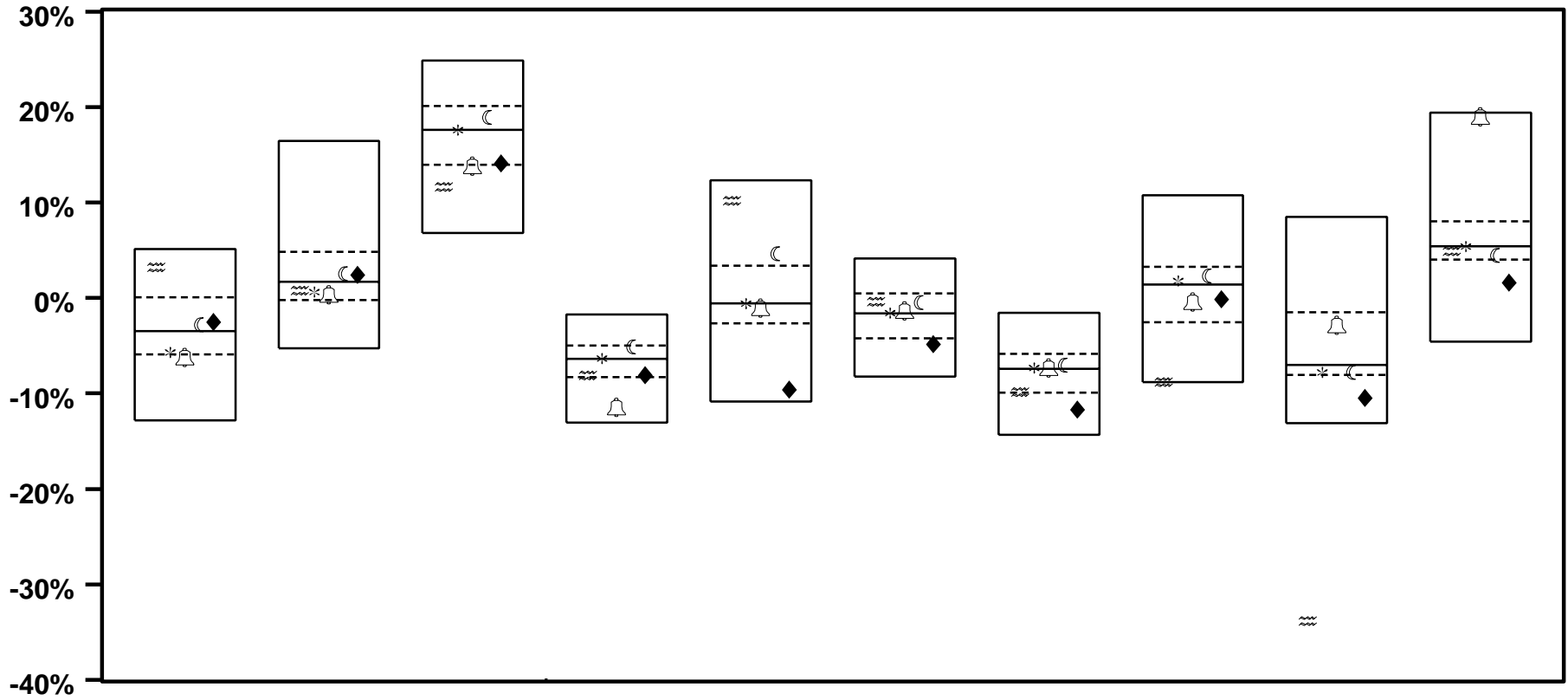

	CONSUMER DISCR		CONSUMER STAPLES		EN-ERGY		FINAN-CIALS		HEALTH CARE		INDUST-RIALS		INFO TECH		MATER-IALS		TELECOM SERVICES		UTIL-ITIES	
≈ LAZARD	3.2	9	0.8	59	11.6	85	-8.1	73	10.2	7	-0.4	31	-9.8	74	-8.8	94	-33.8	100	4.9	65
* S&P 500	-5.7	72	0.6	60	17.6	45	-6.4	46	-0.6	51	-1.6	49	-7.3	48	1.8	41	-7.8	66	5.4	56
🔔 R 1000(R) GR	-6.2	76	0.4	70	13.8	76	-11.4	91	-1.0	62	-1.3	41	-7.3	49	-0.4	63	-2.8	27	19.0	6
🌙 R 1000(R) VALUE	-2.8	43	2.6	40	18.9	31	-5.1	27	4.6	18	-0.5	32	-7.0	36	2.3	32	-7.8	66	4.5	72
◆ R 2000(R)	-2.5	41	2.4	45	14.1	73	-8.1	72	-9.6	94	-4.8	79	-11.7	87	-0.1	60	-10.5	92	1.6	84
MEDIAN	-3.5		1.7		17.6		-6.4		-0.6		-1.6		-7.4		1.4		-7.0		5.4	

VERMONT MUNICIPAL EMPLOYEES

RATES OF RETURN BY INDUSTRY SECTOR

YEAR ENDING 3/05

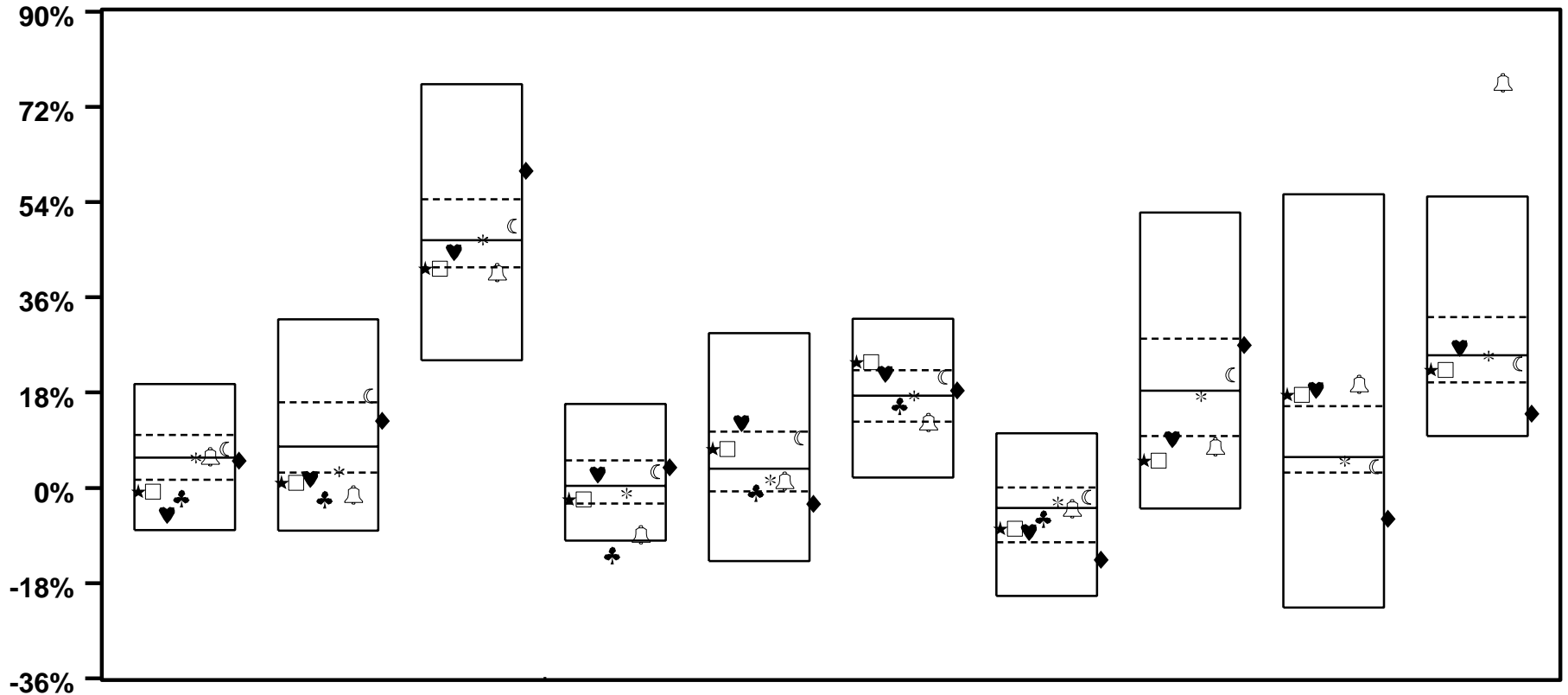

	CONSUMER DISCR		CONSUMER STAPLES		EN-ERGY		FINAN-CIALS		HEALTH CARE		INDUST-RIALS		INFO TECH		MATER-IALS		TELECOM SERVICES		UTIL-ITIES	
★ MUNI COMPOSITE	-0.7	82	1.0	84	41.5	75	-2.2	72	7.3	39	23.7	19	-7.7	67	5.2	84	17.6	21	22.3	68
□ EQTY COMPOSITE	-0.7	82	1.0	84	41.5	75	-2.2	72	7.3	39	23.7	19	-7.7	67	5.2	84	17.6	21	22.3	68
♥ DELAWARE	-5.1	90	1.7	78	44.6	68	2.6	34	12.2	21	21.6	27	-8.3	69	9.2	76	18.5	20	26.5	42
♣ ALLIANCE	-1.9	85	-2.2	90			-12.8	97	-0.9	75	15.5	62	-5.8	59						
* S&P 500	5.6	52	3.0	68	46.9	48	-1.0	57	1.6	57	17.4	53	-2.7	42	17.3	55	5.0	53	24.9	56
🔔 R 1000(R) GR	5.9	44	-1.4	89	40.8	77	-8.8	91	1.3	58	12.3	75	-3.9	50	7.7	80	19.5	19	76.5	1
🌙 R 1000(R) VALUE	7.3	36	17.4	22	49.5	35	3.0	32	9.4	28	20.9	30	-1.8	31	21.3	42	4.0	72	23.4	65
◆ R 2000(R)	5.2	56	12.7	33	60.0	16	3.9	29	-3.0	81	18.4	39	-13.6	83	27.0	28	-5.9	90	14.0	90
MEDIAN	5.7		7.8		46.8		0.4		3.6		17.4		-3.9		18.3		5.8		25.0	

VERMONT MUNICIPAL EMPLOYEES

RATES OF RETURN BY INDUSTRY SECTOR

YEAR ENDING 3/05

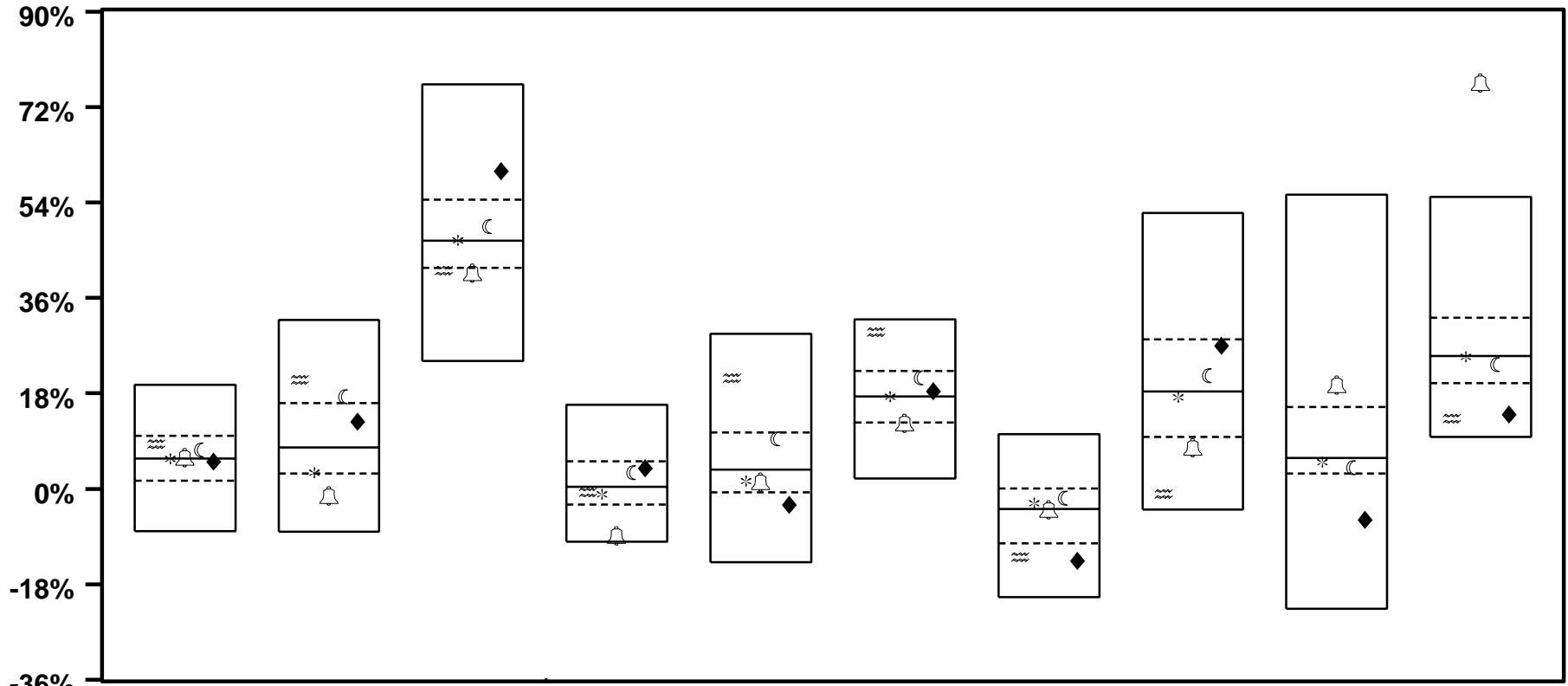

	CONSUMER DISCR		CONSUMER STAPLES		EN-ERGY		FINAN-CIALS		HEALTH CARE		INDUST-RIALS		INFO TECH		MATER-IALS		TELECOM SERVICES		UTIL-ITIES	
≈ LAZARD	8.4	30	20.6	18	41.2	76	-0.6	56	20.9	9	29.6	8	-12.8	81	-1.0	90			13.3	91
* S&P 500	5.6	52	3.0	68	46.9	48	-1.0	57	1.6	57	17.4	53	-2.7	42	17.3	55	5.0	53	24.9	56
🔔 R 1000(R) GR	5.9	44	-1.4	89	40.8	77	-8.8	91	1.3	58	12.3	75	-3.9	50	7.7	80	19.5	19	76.5	1
🌙 R 1000(R) VALUE	7.3	36	17.4	22	49.5	35	3.0	32	9.4	28	20.9	30	-1.8	31	21.3	42	4.0	72	23.4	65
◆ R 2000(R)	5.2	56	12.7	33	60.0	16	3.9	29	-3.0	81	18.4	39	-13.6	83	27.0	28	-5.9	90	14.0	90
MEDIAN	5.7		7.8		46.8		0.4		3.6		17.4		-3.9		18.3		5.8		25.0	

VERMONT MUNICIPAL EMPLOYEES
EQUITY PERFORMANCE ATTRIBUTION
QUARTER ENDING 3/05

MUNICIPAL SYSTEM COMPOSITE

	PORTFOLIO		S&P 500		SELECTION		
	PCT OF BEGIN MKT VAL A	RATE OF RETURN B	PCT OF BEGIN MKT VAL C	RATE OF RETURN D	STOCK E	SECTOR F	TOTAL G
CONS DISCRETIONARY	15.3	-7.7	11.9	-5.7	-0.3	-0.1	-0.4
CONSUMER STAPLES	5.5	1.3	10.5	0.6	0.0	-0.1	-0.1
ENERGY	6.6	14.8	7.2	17.6	-0.2	-0.1	-0.3
FINANCIALS	20.5	-6.9	20.6	-6.4	-0.1	0.0	-0.1
HEALTH CARE	12.5	1.4	12.7	-0.6	0.3	0.0	0.2
INDUSTRIALS	10.1	-0.4	11.8	-1.6	0.1	0.0	0.1
INFO TECHNOLOGY	21.9	-7.5	16.1	-7.3	0.0	-0.3	-0.4
MATERIALS	3.8	-4.8	3.1	1.8	-0.3	0.0	-0.2
TELECOM SERVICES	1.8	-3.1	3.3	-7.8	0.1	0.1	0.2
UTILITIES	1.6	7.3	2.9	5.4	0.0	-0.1	-0.1
MISCELLANEOUS	0.3	-8.6	0.0		0.0	0.0	0.0
	100.0%	-3.2	100.0%	-2.1	-0.4	-0.7	-1.1

EQUITY ONLY BUY&HOLD RETURN (B)	-3.2	STOCK SELECTION (E)	-0.4
BENCHMARK BUY&HOLD RETURN (D)	-2.1	SECTOR WEIGHTING (F)	-0.7
TOTAL RELATIVE RETURN DIFFERENCE (B/D)	-1.1	TOTAL SELECTION (E * F)	-1.1
EQUITY ONLY ACTUAL RETURN (*)	-3.3		
EQUITY ONLY BUY&HOLD RETURN (B)	-3.2		
INTRA-PERIOD TRADING (* / B)	0.0		
TOTAL ACTIVE MANAGEMENT VALUE ADDED (SELECTION * TRADING)	-1.1		

VERMONT MUNICIPAL EMPLOYEES
EQUITY PERFORMANCE ATTRIBUTION
QUARTER ENDING 3/05

DOMESTIC EQUITY COMPOSITE

	PORTFOLIO		S&P 500		SELECTION		
	PCT OF BEGIN MKT VAL A	RATE OF RETURN B	PCT OF BEGIN MKT VAL C	RATE OF RETURN D	STOCK E	SECTOR F	TOTAL G
CONS DISCRETIONARY	15.3	-7.7	11.9	-5.7	-0.3	-0.1	-0.4
CONSUMER STAPLES	5.5	1.3	10.5	0.6	0.0	-0.1	-0.1
ENERGY	6.6	14.8	7.2	17.6	-0.2	-0.1	-0.3
FINANCIALS	20.5	-6.9	20.6	-6.4	-0.1	0.0	-0.1
HEALTH CARE	12.5	1.4	12.7	-0.6	0.3	0.0	0.2
INDUSTRIALS	10.1	-0.4	11.8	-1.6	0.1	0.0	0.1
INFO TECHNOLOGY	21.9	-7.5	16.1	-7.3	0.0	-0.3	-0.4
MATERIALS	3.8	-4.8	3.1	1.8	-0.3	0.0	-0.2
TELECOM SERVICES	1.8	-3.1	3.3	-7.8	0.1	0.1	0.2
UTILITIES	1.6	7.3	2.9	5.4	0.0	-0.1	-0.1
MISCELLANEOUS	0.3	-8.6	0.0		0.0	0.0	0.0
	100.0%	-3.2	100.0%	-2.1	-0.4	-0.7	-1.1

EQUITY ONLY BUY&HOLD RETURN (B)	-3.2	STOCK SELECTION (E)	-0.4
BENCHMARK BUY&HOLD RETURN (D)	-2.1	SECTOR WEIGHTING (F)	-0.7
TOTAL RELATIVE RETURN DIFFERENCE (B/D)	-1.1	TOTAL SELECTION (E * F)	-1.1
EQUITY ONLY ACTUAL RETURN (*)	-3.3		
EQUITY ONLY BUY&HOLD RETURN (B)	-3.2		
INTRA-PERIOD TRADING (* / B)	0.0		
TOTAL ACTIVE MANAGEMENT VALUE ADDED (SELECTION * TRADING)	-1.1		

VERMONT MUNICIPAL EMPLOYEES
EQUITY PERFORMANCE ATTRIBUTION
QUARTER ENDING 3/05

DELAWARE

PORTFOLIO	R 1000(R) VALUE		SELECTION				
	PCT OF BEGIN MKT VAL A	RATE OF RETURN B	PCT OF BEGIN MKT VAL C	RATE OF RETURN D	STOCK E	SECTOR F	TOTAL G
CONS DISCRETIONARY	11.6	-9.3	10.7	-2.8	-0.8	0.0	-0.8
CONSUMER STAPLES	8.3	-0.6	6.4	2.6	-0.3	0.0	-0.2
ENERGY	7.4	19.1	11.6	18.9	0.0	-0.8	-0.8
FINANCIALS	27.9	-5.5	32.8	-5.1	-0.1	0.3	0.1
HEALTH CARE	10.8	3.7	3.7	4.6	-0.1	0.3	0.2
INDUSTRIALS	12.4	1.1	12.5	-0.5	0.2	0.0	0.2
INFO TECHNOLOGY	8.3	0.0	5.9	-7.0	0.6	-0.2	0.4
MATERIALS	6.1	-2.5	5.1	2.3	-0.3	0.0	-0.3
TELECOM SERVICES	4.3	-0.9	5.3	-7.8	0.3	0.1	0.4
UTILITIES	2.8	8.3	6.2	4.5	0.1	-0.1	0.0
MISCELLANEOUS	0.0		0.0				
	100.0%	-0.7	100.0%	0.0	-0.3	-0.4	-0.7

EQUITY ONLY BUY&HOLD RETURN (B)	-0.7	STOCK SELECTION (E)	-0.3
BENCHMARK BUY&HOLD RETURN (D)	0.0	SECTOR WEIGHTING (F)	-0.4
TOTAL RELATIVE RETURN DIFFERENCE (B/D)	-0.7	TOTAL SELECTION (E * F)	-0.7
EQUITY ONLY ACTUAL RETURN (*)	-1.3		
EQUITY ONLY BUY&HOLD RETURN (B)	-0.7		
INTRA-PERIOD TRADING (* / B)	-0.6		
TOTAL ACTIVE MANAGEMENT VALUE ADDED (SELECTION * TRADING)	-1.3		

VERMONT MUNICIPAL EMPLOYEES
EQUITY PERFORMANCE ATTRIBUTION
QUARTER ENDING 3/05

ALLIANCE LARGE CAP GROWTH FUND

	PORTFOLIO		R 1000(R) GR		SELECTION		
	PCT OF BEGIN MKT VAL A	RATE OF RETURN B	PCT OF BEGIN MKT VAL C	RATE OF RETURN D	STOCK E	SECTOR F	TOTAL G
CONS DISCRETIONARY	18.7	-12.7	14.6	-6.2	-1.2	-0.1	-1.3
CONSUMER STAPLES	5.1	4.7	12.3	0.4	0.2	-0.3	-0.1
ENERGY	4.2	11.2	1.4	13.8	-0.1	0.5	0.4
FINANCIALS	13.4	-8.9	9.3	-11.4	0.3	-0.3	0.0
HEALTH CARE	15.6	-4.0	23.7	-1.0	-0.5	-0.3	-0.7
INDUSTRIALS	4.6	-4.8	9.1	-1.3	-0.2	-0.1	-0.3
INFO TECHNOLOGY	38.4	-8.5	27.2	-7.3	-0.5	-0.4	-0.9
MATERIALS	0.0		1.2	-0.4	0.0	0.0	0.0
TELECOM SERVICES	0.0		1.0	-2.8	0.0	0.0	0.0
UTILITIES	0.0		0.2	19.0	0.0	0.0	0.0
MISCELLANEOUS	0.0		0.0				
	100.0%	-7.0	100.0%	-4.1	-1.9	-1.1	-3.0

EQUITY ONLY BUY&HOLD RETURN (B)	-7.0	STOCK SELECTION (E)	-1.9
BENCHMARK BUY&HOLD RETURN (D)	-4.1	SECTOR WEIGHTING (F)	-1.1
TOTAL RELATIVE RETURN DIFFERENCE (B/D)	-3.0	TOTAL SELECTION (E * F)	-3.0
EQUITY ONLY ACTUAL RETURN (*)	-6.2		
EQUITY ONLY BUY&HOLD RETURN (B)	-7.0		
INTRA-PERIOD TRADING (* / B)	0.8		
TOTAL ACTIVE MANAGEMENT VALUE ADDED (SELECTION * TRADING)	-2.2		

VERMONT MUNICIPAL EMPLOYEES
EQUITY PERFORMANCE ATTRIBUTION
QUARTER ENDING 3/05

LAZARD SMALL CAP FUND

	PORTFOLIO		R 2000(R)		SELECTION		
	PCT OF BEGIN MKT VAL A	RATE OF RETURN B	PCT OF BEGIN MKT VAL C	RATE OF RETURN D	STOCK E	SECTOR F	TOTAL G
CONS DISCRETIONARY	16.3	3.2	14.8	-2.5	0.9	0.0	1.0
CONSUMER STAPLES	1.6	0.8	2.6	2.4	0.0	-0.1	-0.1
ENERGY	9.0	11.6	5.4	14.1	-0.2	0.7	0.5
FINANCIALS	19.3	-8.1	22.2	-8.1	0.0	0.1	0.1
HEALTH CARE	10.5	10.2	12.7	-9.6	2.1	0.1	2.2
INDUSTRIALS	15.0	-0.4	14.3	-4.8	0.7	0.0	0.7
INFO TECHNOLOGY	18.6	-9.8	17.5	-11.7	0.4	-0.1	0.3
MATERIALS	6.0	-8.8	6.0	-0.1	-0.5	0.0	-0.5
TELECOM SERVICES	0.5	-33.8	1.0	-10.5	-0.1	0.0	-0.1
UTILITIES	2.1	4.9	3.3	1.6	0.1	-0.1	0.0
MISCELLANEOUS	1.1	-8.6	0.2		-0.1	0.1	0.0
	100.0%	-1.5	100.0%	-5.4	3.3	0.8	4.1

EQUITY ONLY BUY&HOLD RETURN (B)	-1.5	STOCK SELECTION (E)	3.3
BENCHMARK BUY&HOLD RETURN (D)	-5.4	SECTOR WEIGHTING (F)	0.8
TOTAL RELATIVE RETURN DIFFERENCE (B/D)	4.1	TOTAL SELECTION (E * F)	4.1
EQUITY ONLY ACTUAL RETURN (*)	-1.8		
EQUITY ONLY BUY&HOLD RETURN (B)	-1.5		
INTRA-PERIOD TRADING (* / B)	-0.4		
TOTAL ACTIVE MANAGEMENT VALUE ADDED (SELECTION * TRADING)	3.7		

VERMONT MUNICIPAL EMPLOYEES
HISTORICAL EQUITY ATTRIBUTION
PERIODS ENDING 3/05

MUNICIPAL SYSTEM COMPOSITE

	EQUITY ONLY BUY&HOLD RETURN	BENCHMARK RETURN	STOCK	SECTOR	TOTAL	SELECTION IMPACT	INTRA MONTH TRADING	TOTAL VALUE ADDED
LAST QTR	- 3.2	- 2.1	- 0.4	- 0.7	- 1.1	- 1.1	0.0	- 1.1
LAST 2 QTRS	5.7	6.8	- 0.6	- 0.5	- 1.1	- 1.1	0.4	- 0.6
LAST 3 QTRS	2.5	4.8	- 1.2	- 1.1	- 2.2	- 2.2	0.2	- 2.0
LAST YEAR	4.2	6.6	- 1.0	- 1.3	- 2.3	- 2.3	0.4	- 1.9
LAST 2 YEARS	19.5	20.0	0.0	- 0.4	- 0.4	- 0.4	0.9	0.5
LAST 3 YEARS	1.6	2.8	- 1.0	- 0.1	- 1.1	- 1.1	1.1	- 0.1
LAST 4 YEARS								
LAST 5 YEARS								
YEAR ENDING 12/04	9.5	10.8	- 0.6	- 0.6	- 1.2	- 1.2	1.2	0.0
YEAR ENDING 12/03	30.3	28.6	0.7	0.6	1.3	1.3	0.3	1.6

BENCHMARK: S&P 500

VERMONT MUNICIPAL EMPLOYEES
HISTORICAL EQUITY ATTRIBUTION
PERIODS ENDING 3/05

DOMESTIC EQUITY COMPOSITE

	EQUITY ONLY BUY&HOLD RETURN	BENCHMARK RETURN	STOCK	SECTOR	TOTAL	SELECTION IMPACT	INTRA MONTH TRADING	TOTAL VALUE ADDED
LAST QTR	- 3.2	- 2.1	- 0.4	- 0.7	- 1.1	- 1.1	0.0	- 1.1
LAST 2 QTRS	5.7	6.8	- 0.6	- 0.5	- 1.1	- 1.1	0.4	- 0.6
LAST 3 QTRS	2.5	4.8	- 1.2	- 1.1	- 2.2	- 2.2	0.2	- 2.0
LAST YEAR	4.2	6.6	- 1.0	- 1.3	- 2.3	- 2.3	0.4	- 1.9
LAST 2 YEARS	19.5	20.0	0.0	- 0.4	- 0.4	- 0.4	0.9	0.5
LAST 3 YEARS	1.6	2.8	- 1.0	- 0.1	- 1.1	- 1.1	1.1	- 0.1
LAST 4 YEARS								
LAST 5 YEARS								
YEAR ENDING 12/04	9.5	10.8	- 0.6	- 0.6	- 1.2	- 1.2	1.2	0.0
YEAR ENDING 12/03	30.3	28.6	0.7	0.6	1.3	1.3	0.3	1.6

BENCHMARK: S&P 500

VERMONT MUNICIPAL EMPLOYEES
HISTORICAL EQUITY ATTRIBUTION
PERIODS ENDING 3/05

DELAWARE

	EQUITY ONLY BUY&HOLD RETURN	BENCHMARK RETURN	STOCK	SECTOR	TOTAL	SELECTION IMPACT	INTRA MONTH TRADING	TOTAL VALUE ADDED
LAST QTR	- 0.7	0.0	- 0.3	- 0.4	- 0.7	- 0.7	- 0.6	- 1.3
LAST 2 QTRS	7.8	10.4	- 2.7	0.4	- 2.3	- 2.3	- 0.4	- 2.7
LAST 3 QTRS	7.0	12.1	- 3.4	- 1.3	- 4.6	- 4.6	- 0.8	- 5.3
LAST YEAR	8.8	13.0	- 3.2	- 0.5	- 3.7	- 3.7	- 0.6	- 4.3
LAST 2 YEARS	22.7	26.1	- 2.1	- 0.6	- 2.7	- 2.7	0.0	- 2.7
LAST 3 YEARS	4.9	5.8	- 0.9	0.1	- 0.8	- 0.8	0.1	- 0.7
LAST 4 YEARS								
LAST 5 YEARS								
YEAR ENDING 12/04	11.0	16.4	- 4.0	- 0.6	- 4.6	- 4.6	0.4	- 4.2
YEAR ENDING 12/03	29.9	30.0	0.2	- 0.3	- 0.1	- 0.1	- 0.3	- 0.4

BENCHMARK: R 1000(R) VALUE

VERMONT MUNICIPAL EMPLOYEES
HISTORICAL EQUITY ATTRIBUTION
PERIODS ENDING 3/05

ALLIANCE LARGE CAP GROWTH FUND

	EQUITY ONLY BUY&HOLD RETURN	BENCHMARK RETURN	STOCK	SECTOR	TOTAL	SELECTION IMPACT	INTRA MONTH TRADING	TOTAL VALUE ADDED
LAST QTR	- 7.0	- 4.1	- 1.9	- 1.1	- 3.0	- 3.0	0.8	- 2.2
LAST 2 QTRS	1.3	4.6	- 2.5	- 0.7	- 3.2	- 3.2	1.2	- 2.1
LAST 3 QTRS	- 4.2	- 0.8	- 1.9	- 1.5	- 3.4	- 3.4	0.8	- 2.6
LAST YEAR	- 3.2	1.2	- 1.9	- 2.5	- 4.4	- 4.4	1.6	- 2.8
LAST 2 YEARS	11.5	15.6	- 2.7	- 0.8	- 3.6	- 3.6	1.2	- 2.4
LAST 3 YEARS	- 4.4	- 0.7	- 3.5	- 0.3	- 3.8	- 3.8	2.1	- 1.8
LAST 4 YEARS								
LAST 5 YEARS								
YEAR ENDING 12/04	5.0	6.4	- 0.1	- 1.3	- 1.3	- 1.3	1.5	0.1
YEAR ENDING 12/03	26.1	29.7	- 2.4	- 0.4	- 2.8	- 2.8	0.0	- 2.8

BENCHMARK: R 1000(R) GR

VERMONT MUNICIPAL EMPLOYEES
HISTORICAL EQUITY ATTRIBUTION
PERIODS ENDING 3/05

LAZARD SMALL CAP FUND

	EQUITY ONLY BUY&HOLD RETURN	BENCHMARK RETURN	STOCK	SECTOR	TOTAL	SELECTION IMPACT	INTRA MONTH TRADING	TOTAL VALUE ADDED
LAST QTR	- 1.5	- 5.4	3.3	0.8	4.1	4.1	- 0.4	3.7
LAST 2 QTRS	8.9	8.0	0.1	0.7	0.9	0.9	0.9	1.8
LAST 3 QTRS	5.5	5.0	- 0.8	1.2	0.4	0.4	1.4	1.8
LAST YEAR	8.3	5.7	0.6	1.8	2.4	2.4	0.4	2.8
LAST 2 YEARS	28.0	31.5	- 3.1	0.4	- 2.7	- 2.7	1.2	- 1.5
LAST 3 YEARS	5.7	8.2	- 1.7	- 0.7	- 2.4	- 2.4	1.4	- 1.0
LAST 4 YEARS								
LAST 5 YEARS								
YEAR ENDING 12/04	14.1	18.7	- 4.8	1.0	- 3.9	- 3.9	1.8	- 2.2
YEAR ENDING 12/03	39.4	47.0	- 4.2	- 1.0	- 5.2	- 5.2	0.4	- 4.8

BENCHMARK: R 2000(R)

VERMONT MUNICIPAL EMPLOYEES

EQUITY ONLY - RATES OF RETURN

COMPARED TO FUNDS WITH SIMILAR BETA

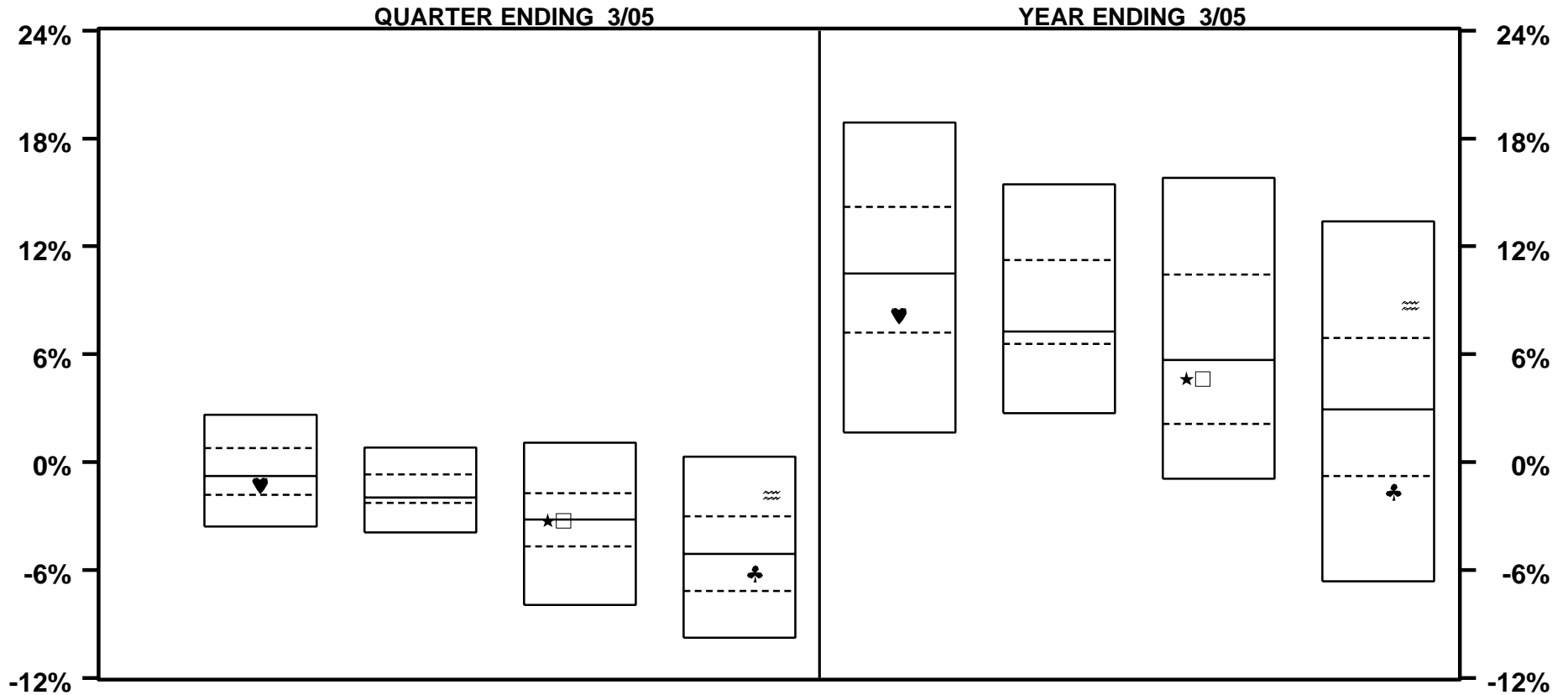

	QUARTER ENDING 3/05				YEAR ENDING 3/05			
	BELOW 1.0	1.0-1.1	1.1-1.2	ABOVE 1.2	BELOW 1.0	1.0-1.1	1.1-1.2	ABOVE 1.2
★ MUNI COMPOSITE			- 3.3 51				4.6 59	
□ EQTY COMPOSITE			- 3.3 51				4.6 59	
♥ DELAWARE	- 1.3 61				8.2 67			
♣ ALLIANCE				- 6.2 66				- 1.7 79
≡ LAZARD				- 1.8 10				8.7 11
MEDIAN	- 0.8	- 2.0	- 3.2	- 5.1	10.5	7.3	5.7	2.9

VERMONT MUNICIPAL EMPLOYEES

EQUITY ONLY - RATES OF RETURN

COMPARED TO FUNDS WITH SIMILAR DIVERSIFICATION

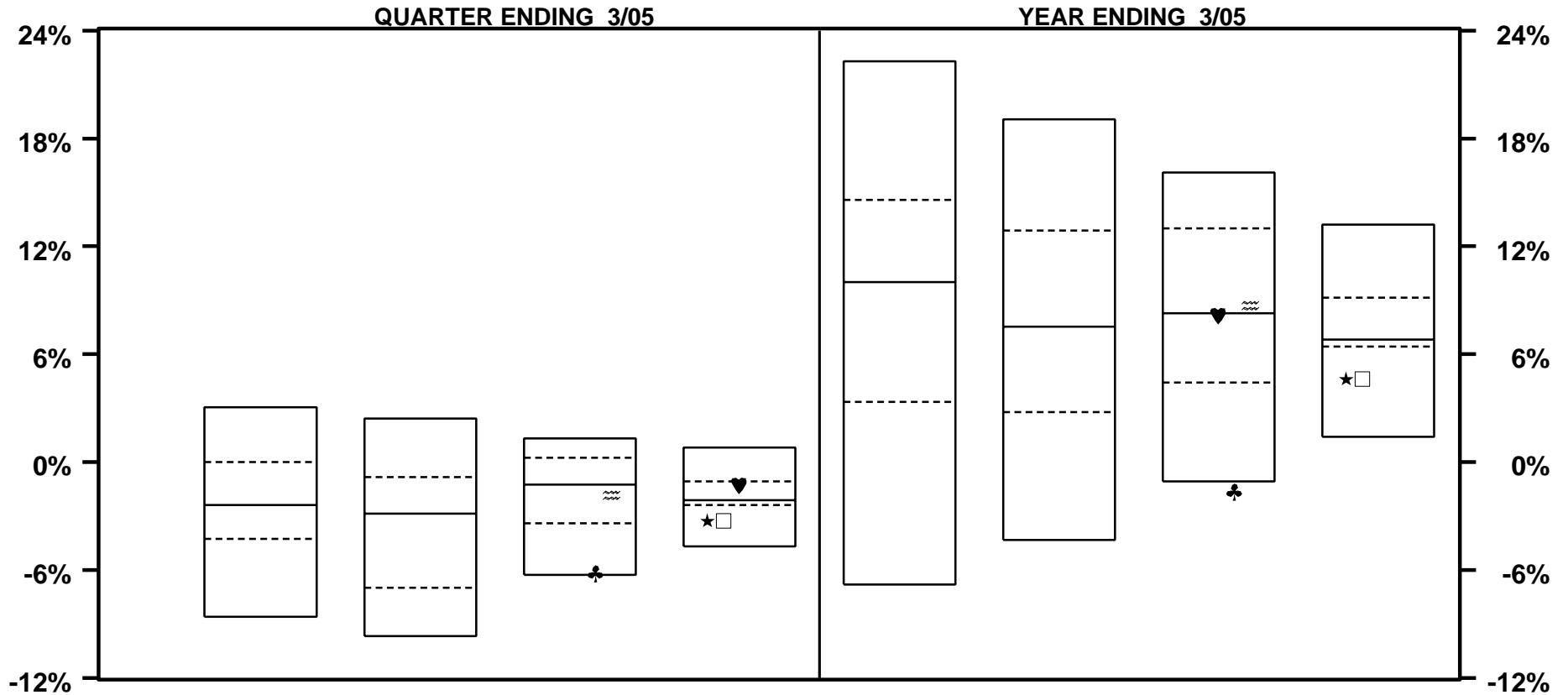

	BELOW 0.85	0.85- 0.90	0.90- 0.95	ABOVE 0.95	BELOW 0.85	0.85- 0.90	0.90- 0.95	ABOVE 0.95
★ MUNI COMPOSITE				- 3.3 85				4.6 84
□ EQTY COMPOSITE				- 3.3 85				4.6 84
♥ DELAWARE				- 1.3 27			8.2 50	
♣ ALLIANCE			- 6.2 93			- 1.7 97		
≍ LAZARD			- 1.8 61			8.7 46		
MEDIAN	- 2.4	- 2.9	- 1.2	- 2.1	10.0	7.5	8.3	6.8

VERMONT MUNICIPAL EMPLOYEES

EQUITY ONLY - RATES OF RETURN

COMPARED TO FUNDS WITH SIMILAR P/E RATIO

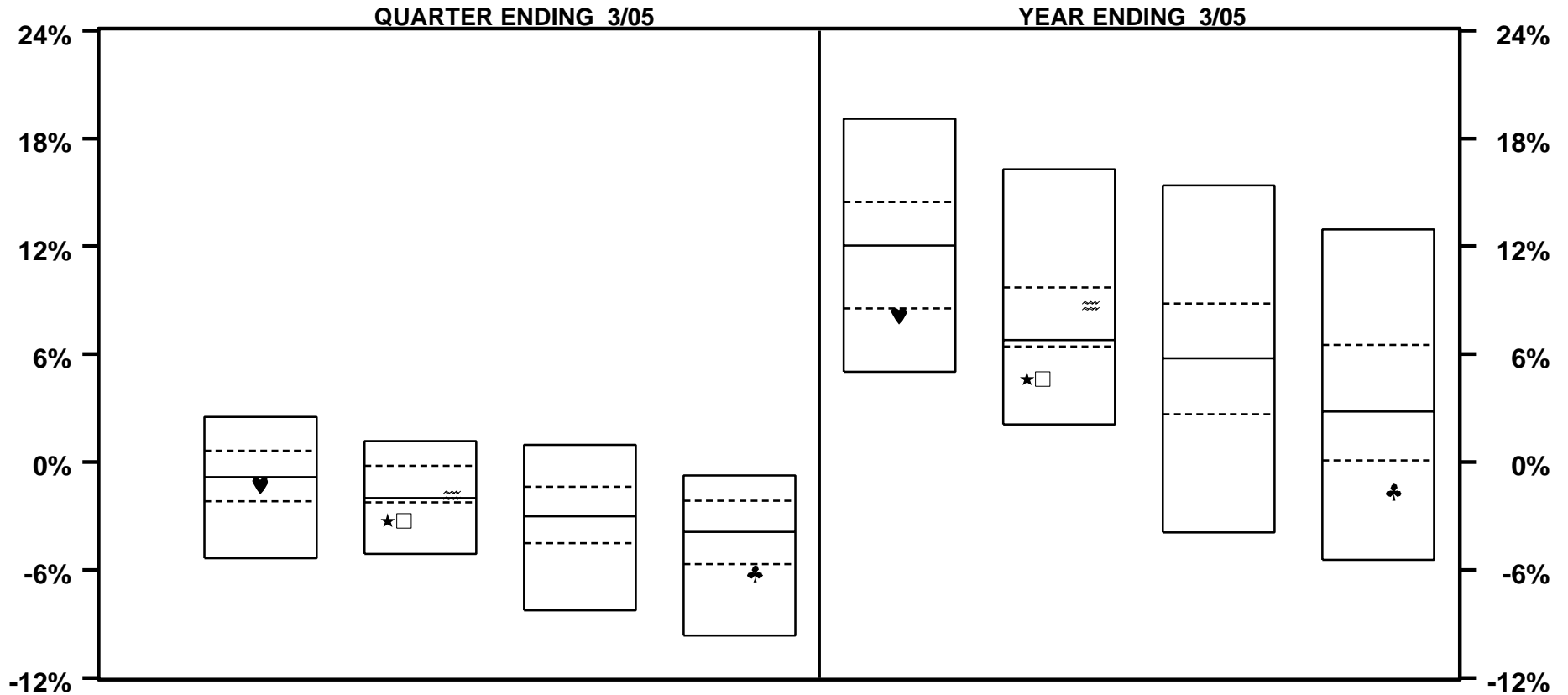

	BELOW 17.5	17.5- 20.0	20.0- 22.5	ABOVE 22.5	BELOW 17.5	17.5- 20.0	20.0- 22.5	ABOVE 22.5
★ MUNI COMPOSITE		- 3.3 89				4.6 86		
□ EQTY COMPOSITE		- 3.3 89				4.6 86		
♥ DELAWARE	- 1.3 60				8.2 77			
♣ ALLIANCE				- 6.2 77				- 1.7 84
≡ LAZARD		- 1.8 47				8.7 29		
MEDIAN	- 0.8	- 2.0	- 3.0	- 3.9	12.0	6.8	5.8	2.8

VERMONT MUNICIPAL EMPLOYEES

EQUITY STYLE SPECTRUM METHODOLOGY

Background:

Equity Style Spectrum analysis is employed in characterizing the investment approach of a managed equity portfolio. It further provides the means for grouping equity portfolios with similar investment styles. While no rule-based methodology can claim to capture all of the decisions made by an investment manager, the size of the firm in which a manager invests and the fundamental growth or value orientation of portfolio constituent holdings serve to explain a significant portion of fund performance.

Exhibits:

The intersection of Size (Y-axis) and Value/Growth (X-axis) coordinates drive equity style spectrum mappings on a nine-quadrant grid. Each of the nine quadrants is bounded by both a metric of size and a measure of value, growth or neutrality. The style map depicts the magnitude of an individual manager's style bias while similarly identifying style gaps and redundancies among multiple investment managers. As style bias is characterized at points in time over extended intervals, the style map similarly captures any "style drift" that may be exhibited.

While portfolio-level assignments are driven by a weighted-average calculation of constituent holding size and value/growth scores, the portfolio cross-sectional distribution of such scores is of additional interest. Consider, for example, that a Mid Cap assignment can result from holding either a portfolio that is concentrated exclusively in mid cap stocks or alternatively as a result of holding both large and small cap names. Similarly, a Core assignment can be accorded to a portfolio that is wholly comprised of constituent holdings that have no style bias (neutral) or equivalently by holding securities that carry both a growth and value bias in equal proportion.

Methodology:

Size scores for constituent holdings are identically the risk index exposure values for Size as obtained from BARRA's US-E3 Equity Risk Model. The log of market capitalization is, in turn, employed in deriving the risk index exposure value.

The Value/Growth score associated with a given portfolio is derived by way of a probabilistic assesment of the tendency toward value and growth exhibited by its constituent portfolio holdings. Value is characterized through an aggregation of BARRA US-E3 risk index exposures to Earnings Yield, Book/Price ratio and Dividend Yield, respectively. Growth is assessed through a consideration of exposure to the US-E3 Growth index.

Size quadrants are bounded per:

Small: Size Exposure < -1.90
Mid: -1.90 <= Size Exposure <= -1.00
Large: Size Exposure > -1.00

Value/Growth quadrants are bounded per:

Value: Value/Growth Exposure < -0.15
Core: -0.15 <= Value/Growth Exposure <= 0.15
Growth: Value/Growth Exposure > 0.15

VERMONT MUNICIPAL EMPLOYEES

EQUITY MANAGER SPECTRUM STYLE ANALYSIS - TOTAL RETURNS

QUARTER ENDING 3/05

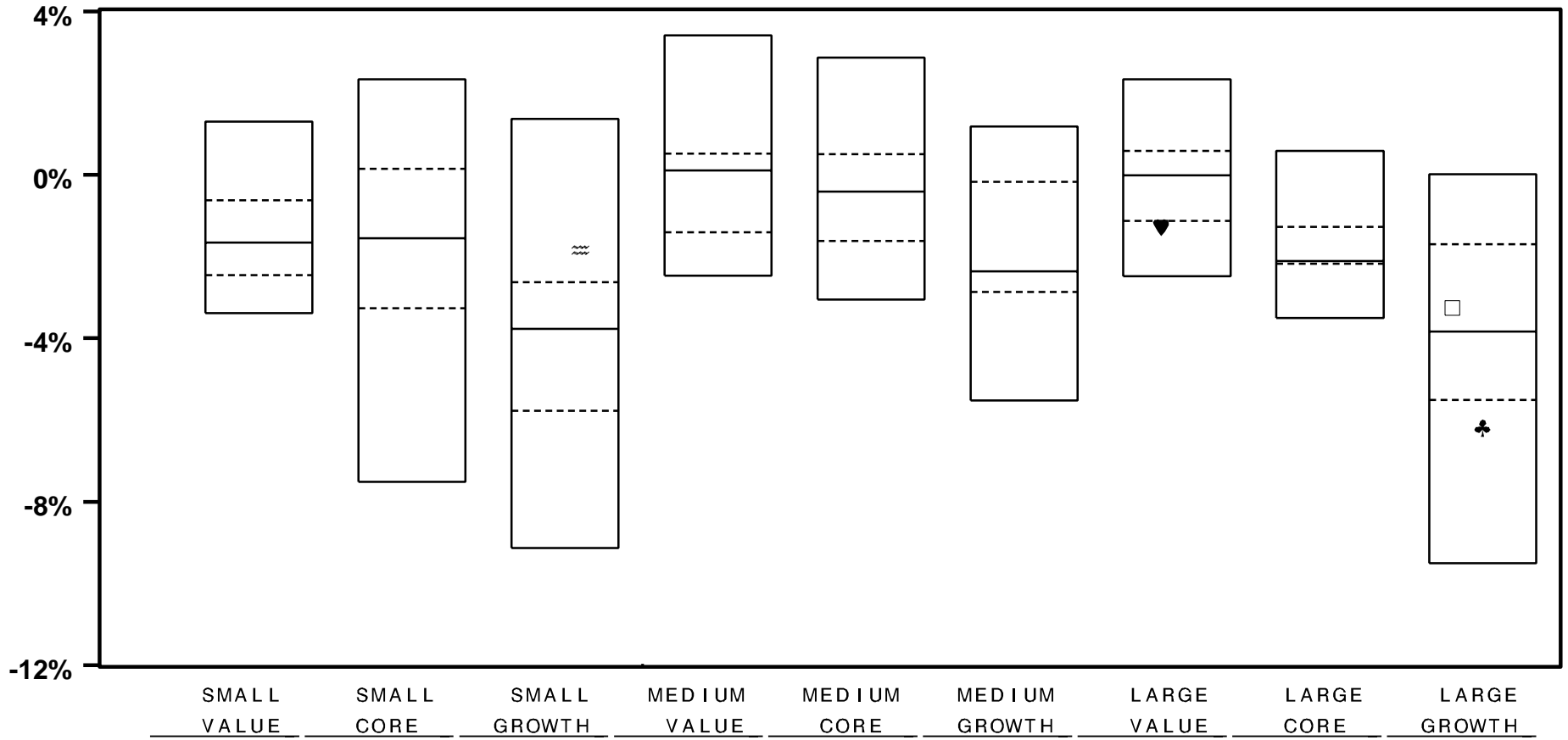

	SMALL VALUE	SMALL CORE	SMALL GROWTH	MEDIUM VALUE	MEDIUM CORE	MEDIUM GROWTH	LARGE VALUE	LARGE CORE	LARGE GROWTH
EQTY COMPOSITE									- 3.3 43
DELAWARE							- 1.3 77		
ALLIANCE									- 6.2 81
LAZARD			- 1.8 17						
MEDIAN	- 1.7	- 1.6	- 3.8	0.1	- 0.4	- 2.4	0.0	- 2.1	- 3.8

VERMONT MUNICIPAL EMPLOYEES

EQUITY MANAGER SPECTRUM STYLE ANALYSIS - TOTAL RETURNS

YEAR ENDING 3/05

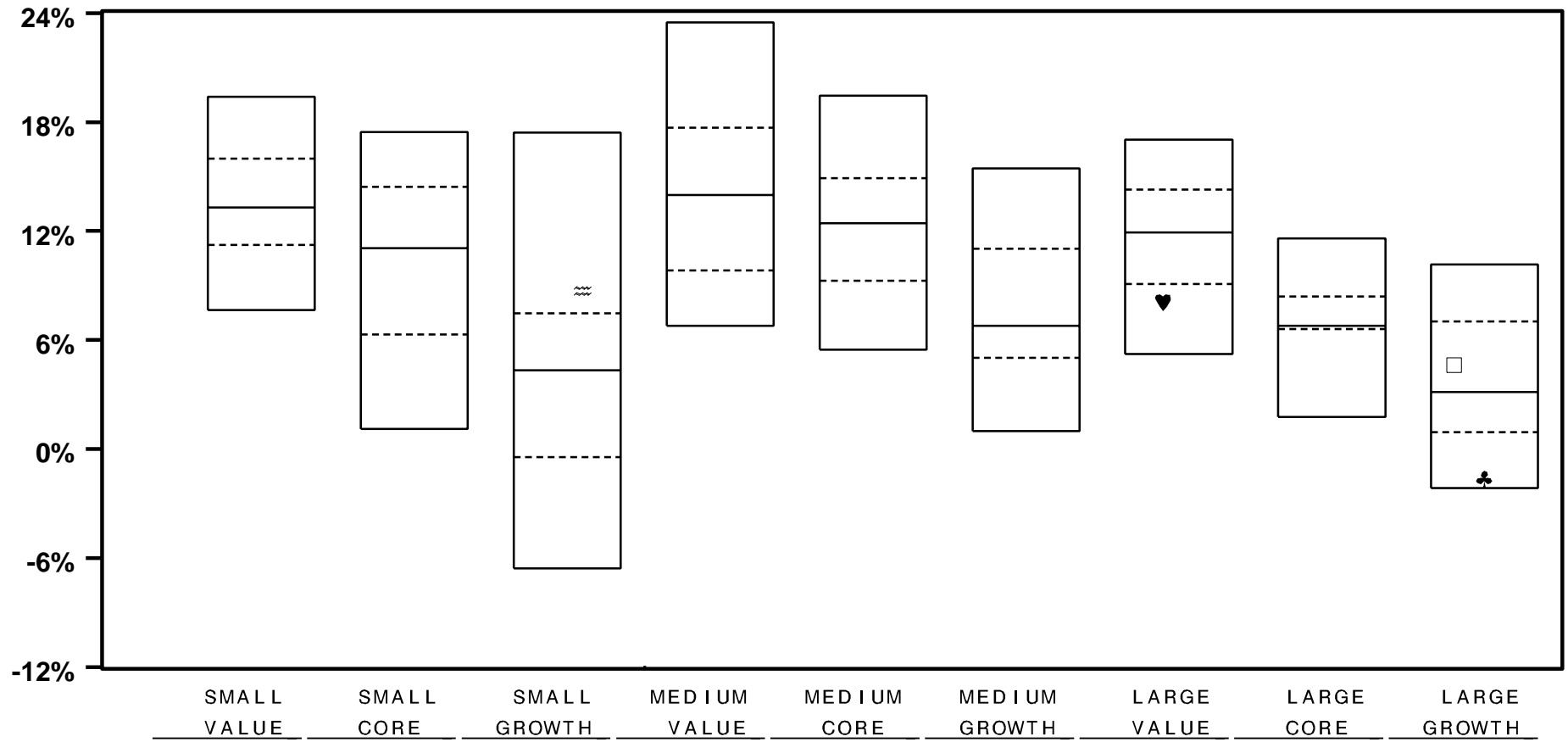

	SMALL	SMALL	SMALL	MEDIUM	MEDIUM	MEDIUM	LARGE	LARGE	LARGE
	VALUE	CORE	GROWTH	VALUE	CORE	GROWTH	VALUE	CORE	GROWTH
□ EQTY COMPOSITE									4.6 38
♥ DELAWARE							8.1 81		
♣ ALLIANCE									-1.7 93
≍ LAZARD			8.7 20						
MEDIAN	13.3	11.1	4.3	14.0	12.4	6.8	11.9	6.8	3.1

VERMONT MUNICIPAL EMPLOYEES

EQUITY MANAGER SPECTRUM STYLE ANALYSIS - TOTAL RETURNS

TWO YEARS ENDING 3/05

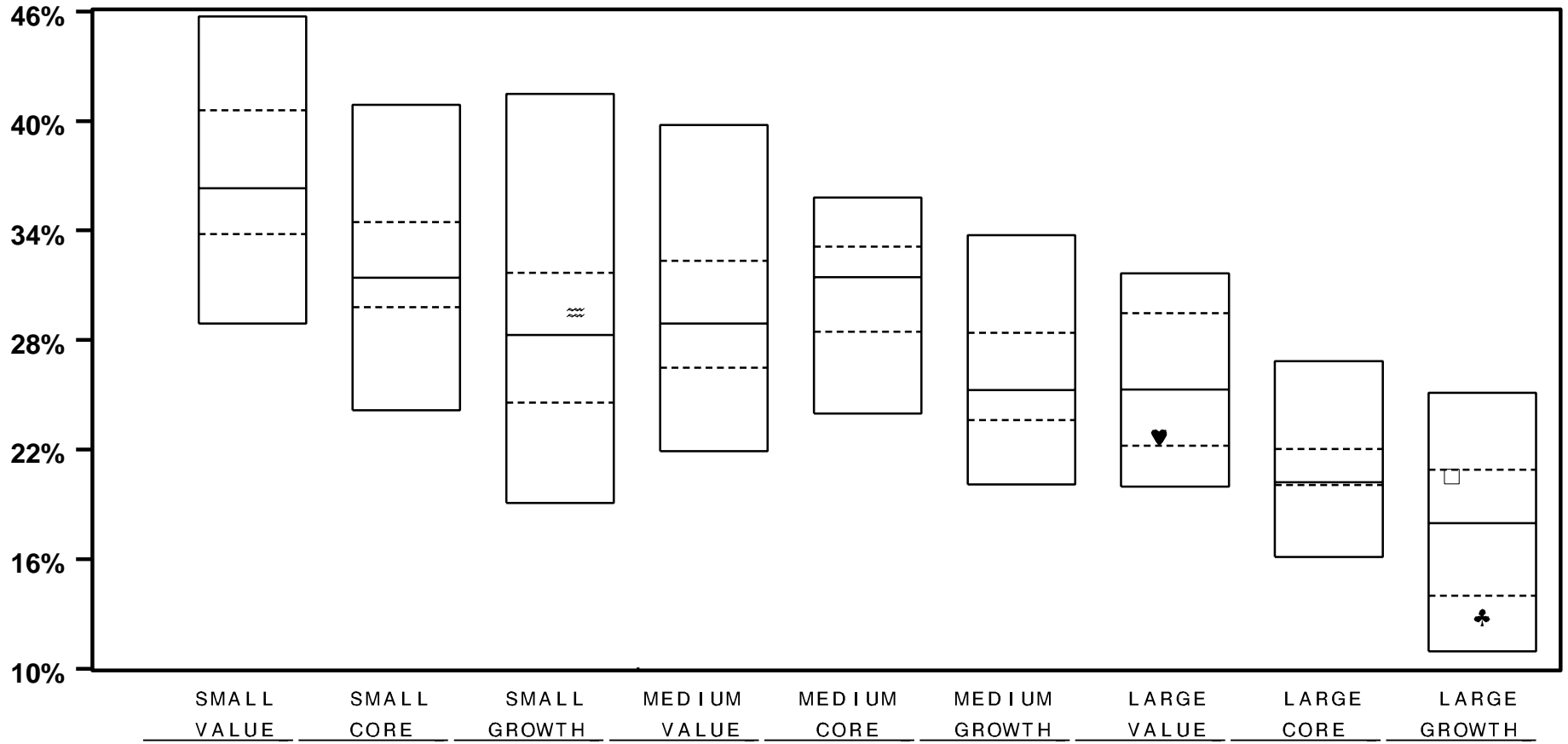

	SMALL VALUE	SMALL CORE	SMALL GROWTH	MEDIUM VALUE	MEDIUM CORE	MEDIUM GROWTH	LARGE VALUE	LARGE CORE	LARGE GROWTH
EQTY COMPOSITE			29.5				22.7		20.5
DELAWARE							72		31
ALLIANCE									12.8
LAZARD			38						84
MEDIAN	36.3	31.4	28.3	28.9	31.4	25.3	25.3	20.2	18.0

VERMONT MUNICIPAL EMPLOYEES

EQUITY MANAGER SPECTRUM STYLE ANALYSIS - TOTAL RETURNS

THREE YEARS ENDING 3/05

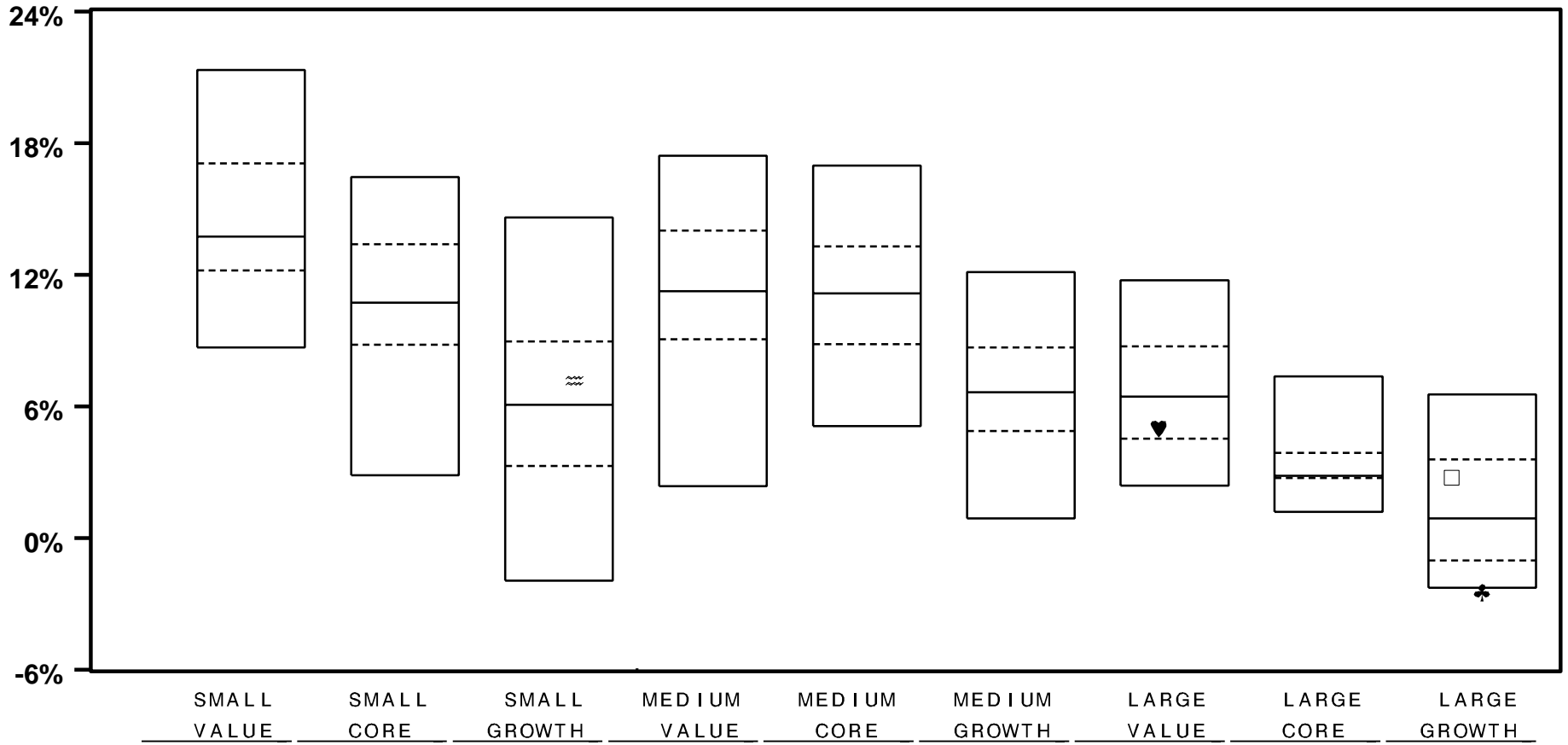

	SMALL VALUE	SMALL CORE	SMALL GROWTH	MEDIUM VALUE	MEDIUM CORE	MEDIUM GROWTH	LARGE VALUE	LARGE CORE	LARGE GROWTH
EQTY COMPOSITE									2.8 38
DELAWARE							5.0 68		
ALLIANCE									-2.5 96
LAZARD			7.2 41						
MEDIAN	13.7	10.7	6.1	11.3	11.1	6.6	6.4	2.8	0.9

VERMONT MUNICIPAL EMPLOYEES

EQUITY MANAGER SPECTRUM STYLE ANALYSIS - TOTAL RETURNS

FOUR YEARS ENDING 3/05

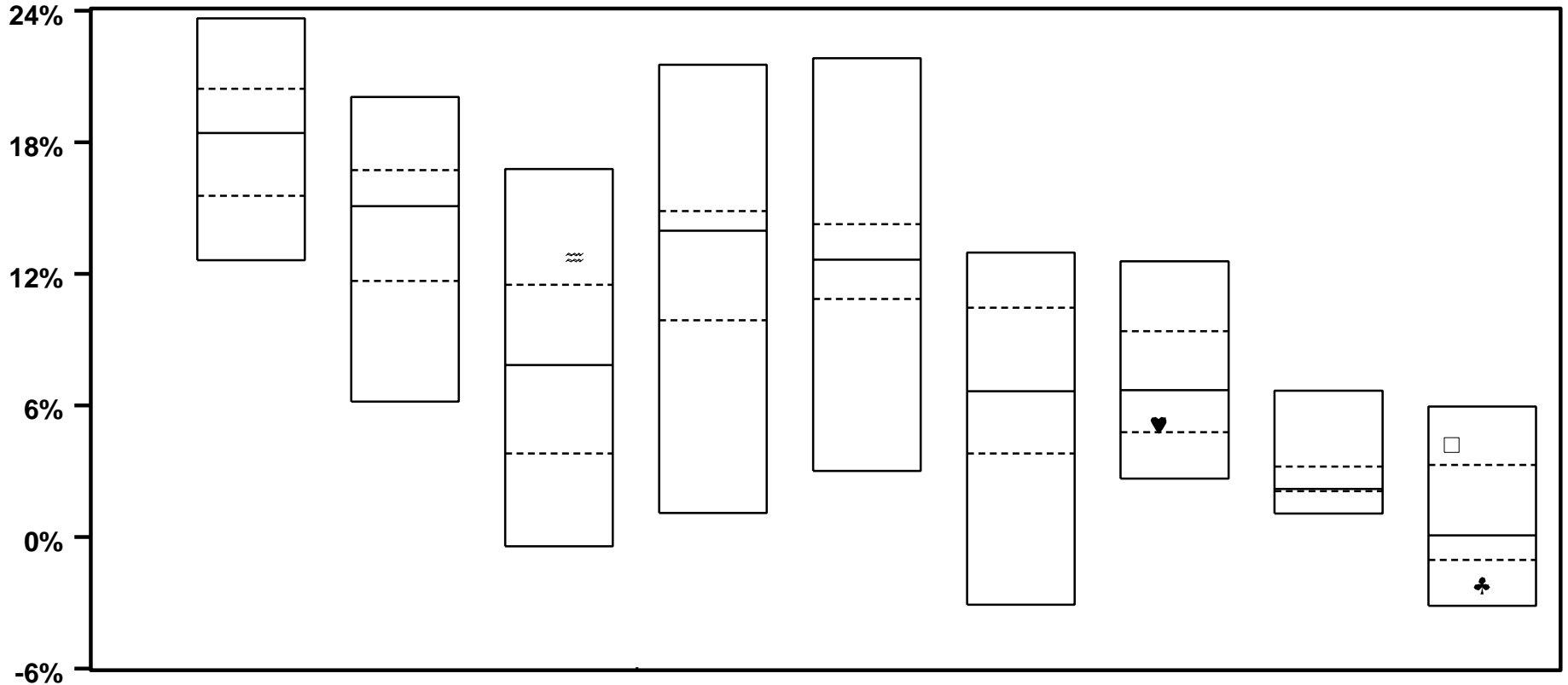

	SMALL VALUE	SMALL CORE	SMALL GROWTH	MEDIUM VALUE	MEDIUM CORE	MEDIUM GROWTH	LARGE VALUE	LARGE CORE	LARGE GROWTH
EQTY COMPOSITE									4.2 16
DELAWARE							5.1 72		
ALLIANCE									-2.2 85
LAZARD			12.8 17						
MEDIAN	18.4	15.1	7.8	14.0	12.6	6.7	6.7	2.2	0.1

VERMONT MUNICIPAL EMPLOYEES

EQUITY MANAGER SPECTRUM STYLE ANALYSIS - TOTAL RETURNS

FIVE YEARS ENDING 3/05

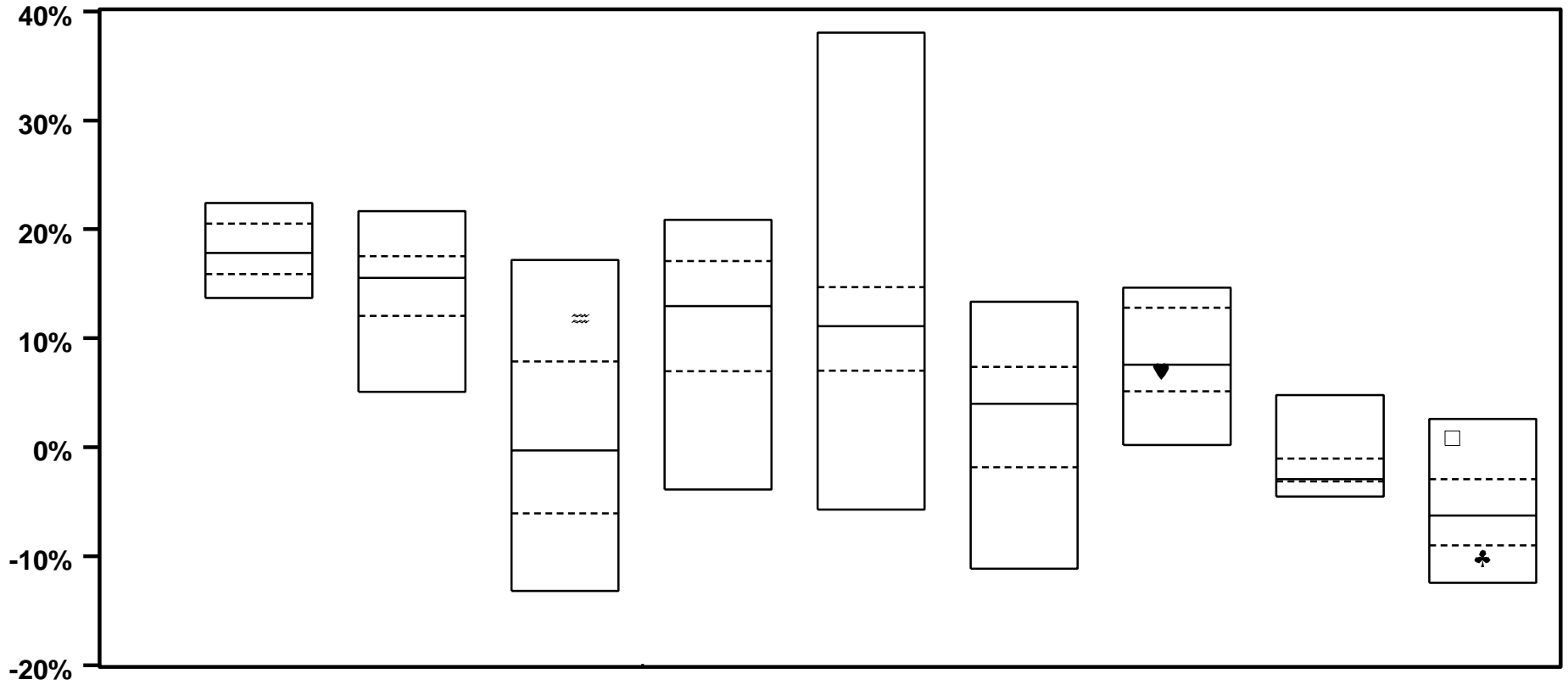

- EQTY COMPOSITE
- ♥ DELAWARE
- ♣ ALLIANCE
- ≡ LAZARD

	0.9	9
7.0	57	
-10.1	84	

	17.9	15.5	-0.3	13.0	11.1	4.0	7.5	-3.0	-6.3
MEDIAN									

VERMONT MUNICIPAL EMPLOYEES

EQUITY MANAGER SPECTRUM STYLE ANALYSIS - TOTAL RETURNS

YEAR ENDING 3/04

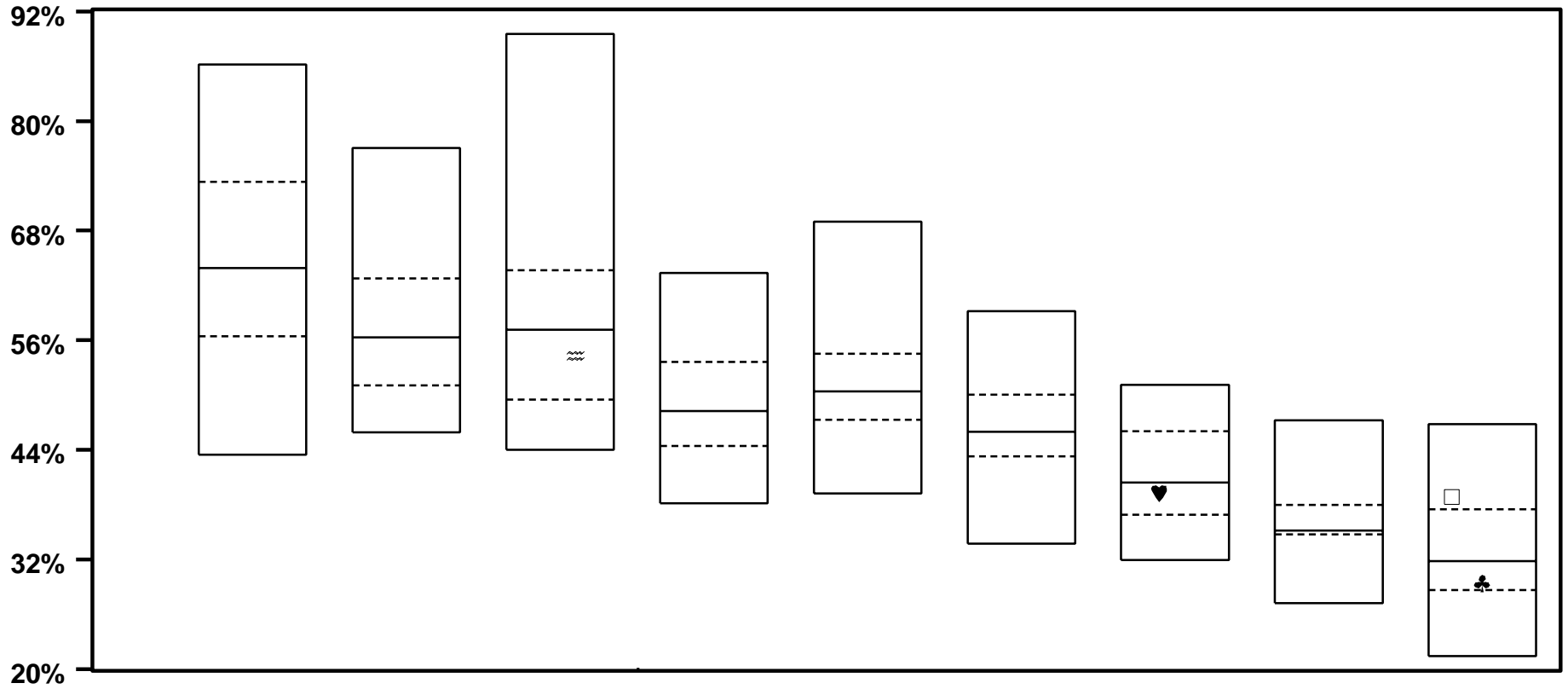

	SMALL VALUE	SMALL CORE	SMALL GROWTH	MEDIUM VALUE	MEDIUM CORE	MEDIUM GROWTH	LARGE VALUE	LARGE CORE	LARGE GROWTH
EQTY COMPOSITE									38.9 23
DELAWARE							39.3 56		
ALLIANCE									29.4 66
LAZARD			54.3 57						
MEDIAN	63.9	56.3	57.1	48.3	50.4	46.0	40.5	35.2	31.8

VERMONT MUNICIPAL EMPLOYEES

EQUITY MANAGER SPECTRUM STYLE ANALYSIS - TOTAL RETURNS

YEAR ENDING 3/03

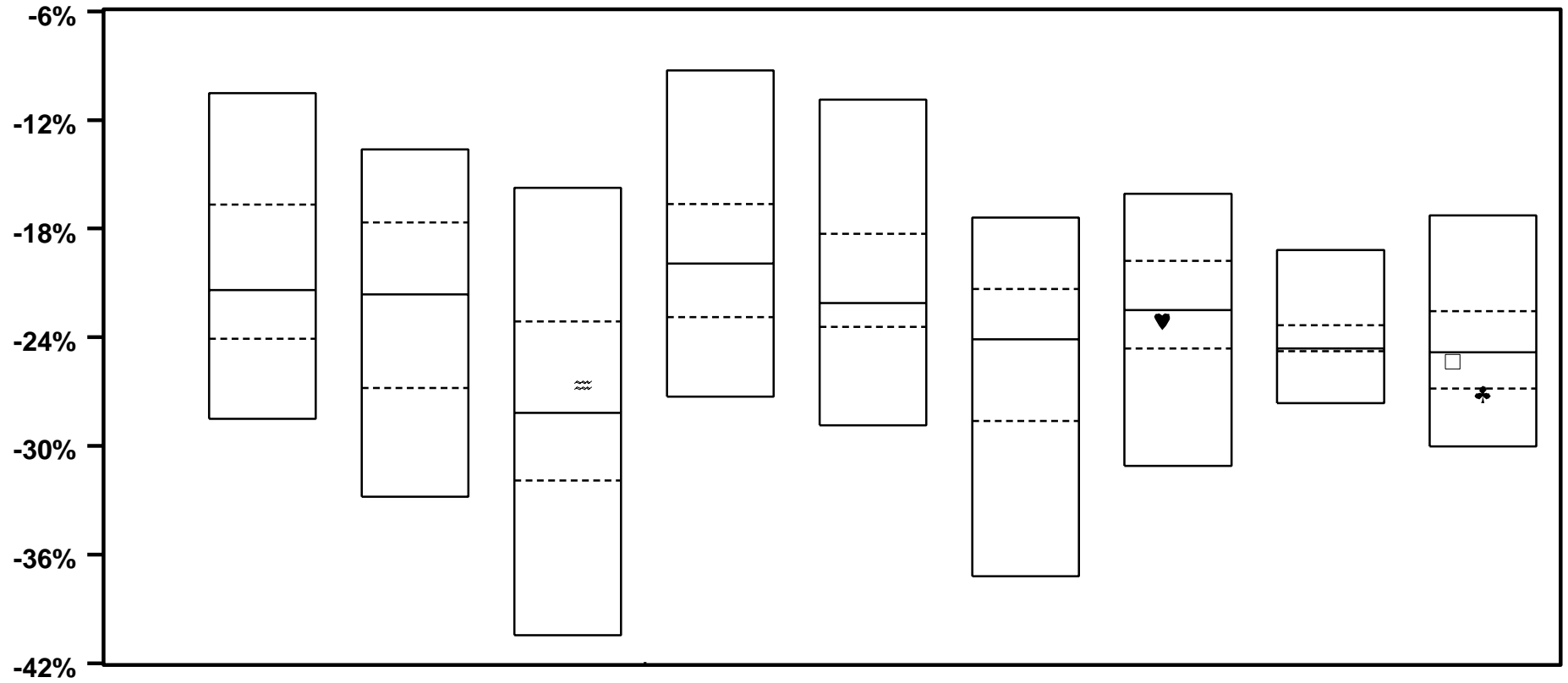

	SMALL VALUE	SMALL CORE	SMALL GROWTH	MEDIUM VALUE	MEDIUM CORE	MEDIUM GROWTH	LARGE VALUE	LARGE CORE	LARGE GROWTH
EQTY COMPOSITE									- 25.3 55
DELAWARE							- 23.1 59		
ALLIANCE									- 27.1 77
LAZARD			- 26.6 43						
MEDIAN	- 21.4	- 21.6	- 28.2	- 19.9	- 22.1	- 24.1	- 22.5	- 24.6	- 24.8

VERMONT MUNICIPAL EMPLOYEES

EQUITY MANAGER SPECTRUM STYLE ANALYSIS - TOTAL RETURNS

YEAR ENDING 3/02

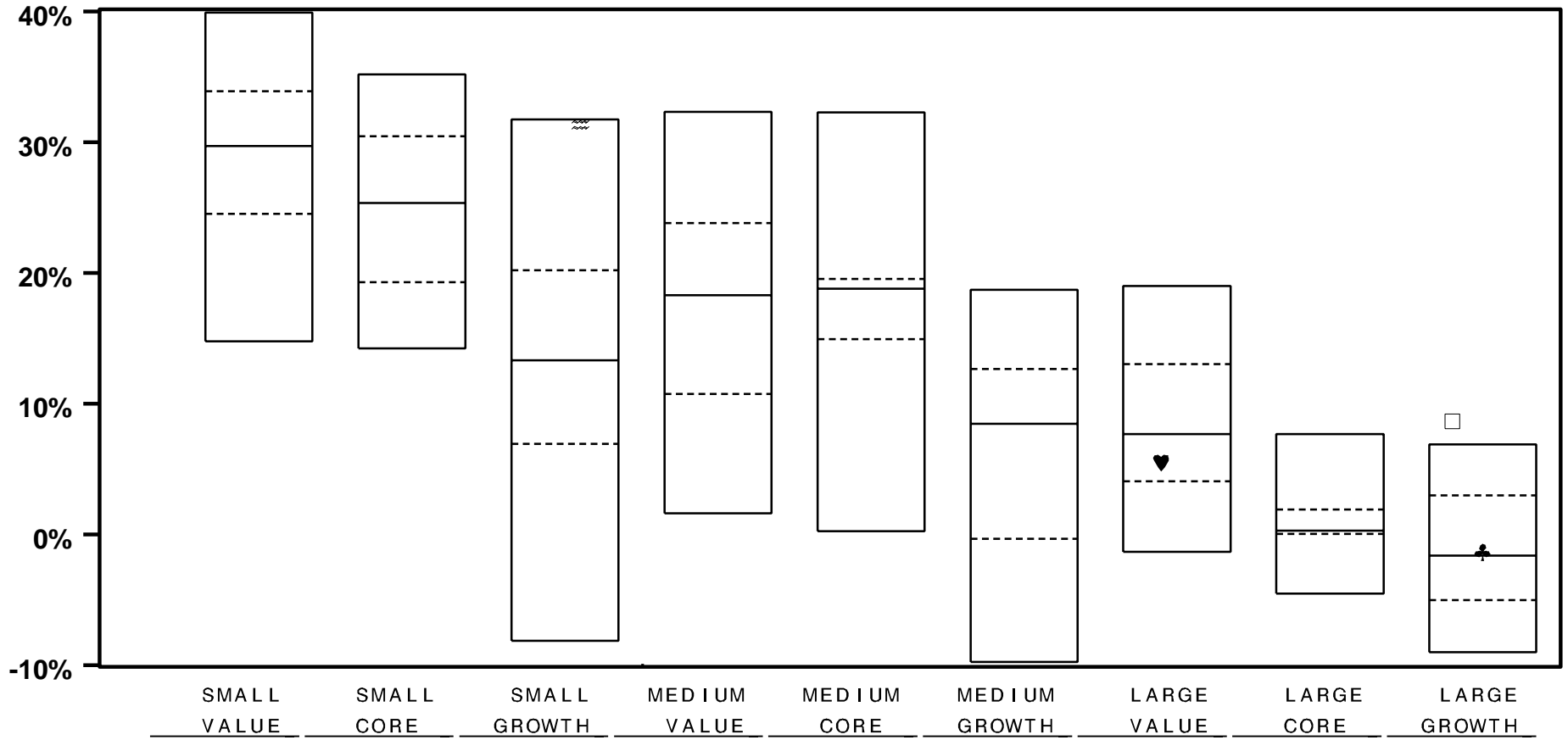

- EQTY COMPOSITE
- ♥ DELAWARE
- ♣ ALLIANCE
- ≡ LAZARD

8.7 2
 5.5 61
 -1.3 47

MEDIAN 29.7 25.3 13.3 18.3 18.8 8.4 7.7 0.3 -1.6

VERMONT MUNICIPAL EMPLOYEES

EQUITY MANAGER SPECTRUM STYLE ANALYSIS - TOTAL RETURNS

YEAR ENDING 3/01

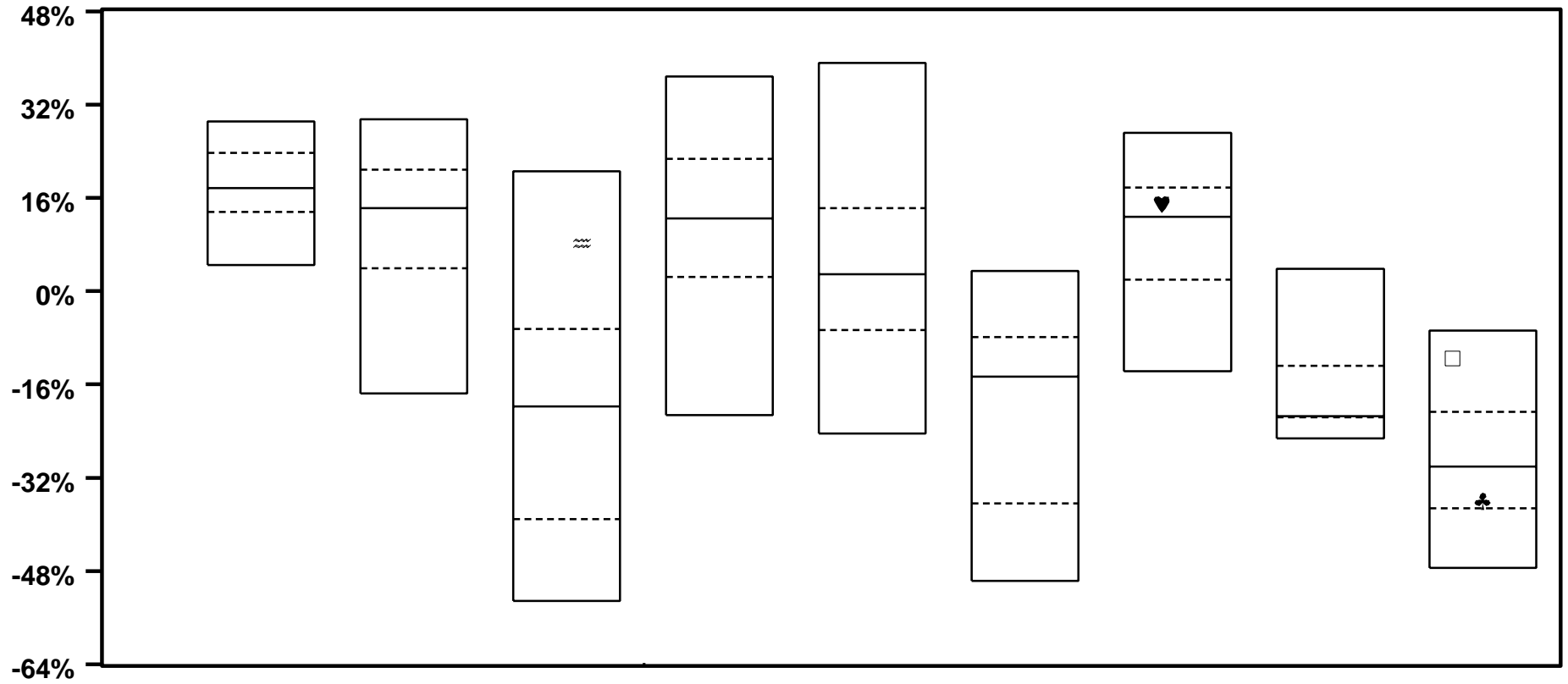

	SMALL VALUE	SMALL CORE	SMALL GROWTH	MEDIUM VALUE	MEDIUM CORE	MEDIUM GROWTH	LARGE VALUE	LARGE CORE	LARGE GROWTH
EQTY COMPOSITE									- 11.5 9
DELAWARE							14.9 40		
ALLIANCE									- 36.0 67
LAZARD			8.3 14						
MEDIAN	17.7	14.3	- 19.8	12.5	2.9	- 14.6	12.8	- 21.5	- 30.1

VERMONT MUNICIPAL EMPLOYEES

EQUITY MANAGER SPECTRUM STYLE ANALYSIS - TOTAL RETURNS

YEAR ENDING 3/00

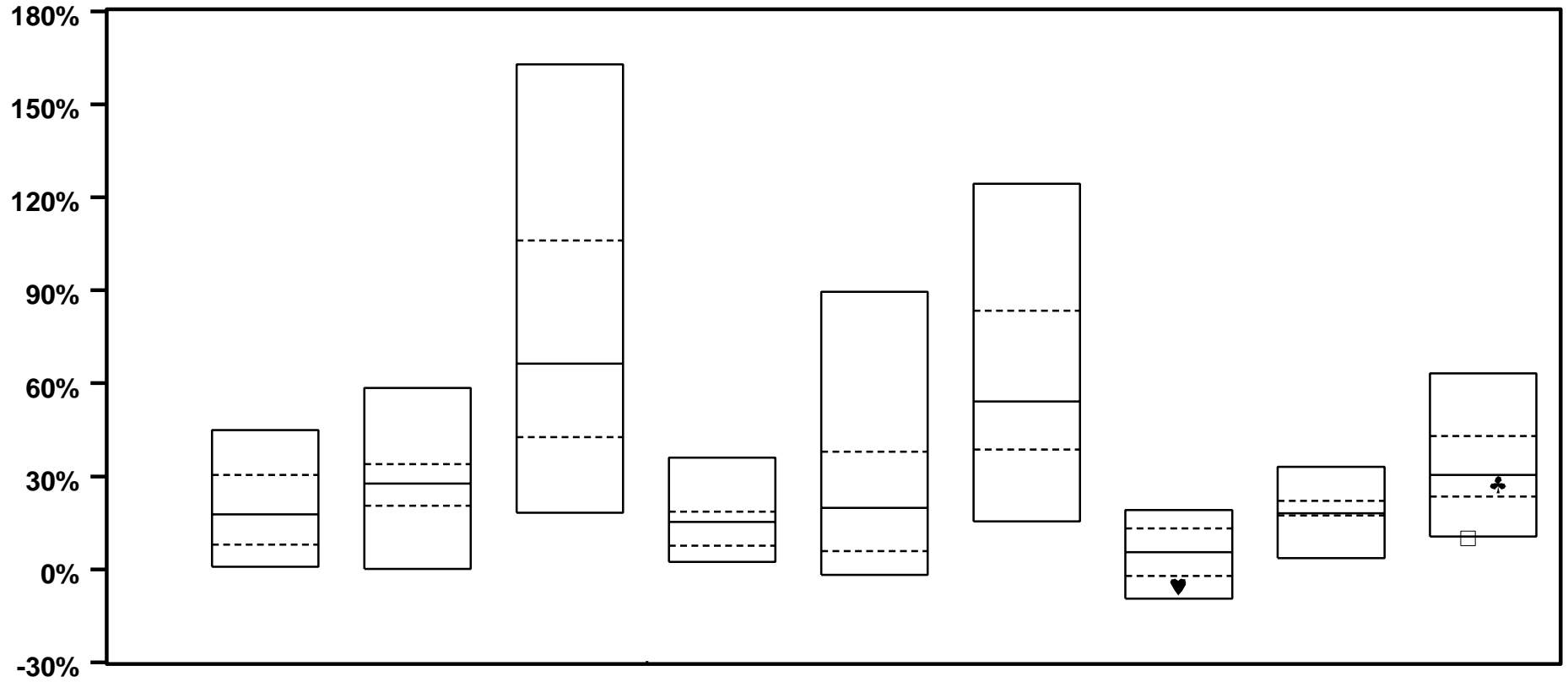

	SMALL VALUE	SMALL CORE	SMALL GROWTH	MEDIUM VALUE	MEDIUM CORE	MEDIUM GROWTH	LARGE VALUE	LARGE CORE	LARGE GROWTH
EQTY COMPOSITE									10.1 96
DELAWARE							- 5.4 83		
ALLIANCE									27.5 61
MEDIAN	17.6	27.6	66.3	15.3	19.8	54.1	5.4	18.0	30.4

VERMONT MUNICIPAL EMPLOYEES

EQUITY MANAGER SPECTRUM STYLE ANALYSIS - EQUITY ONLY RETURNS

QUARTER ENDING 3/05

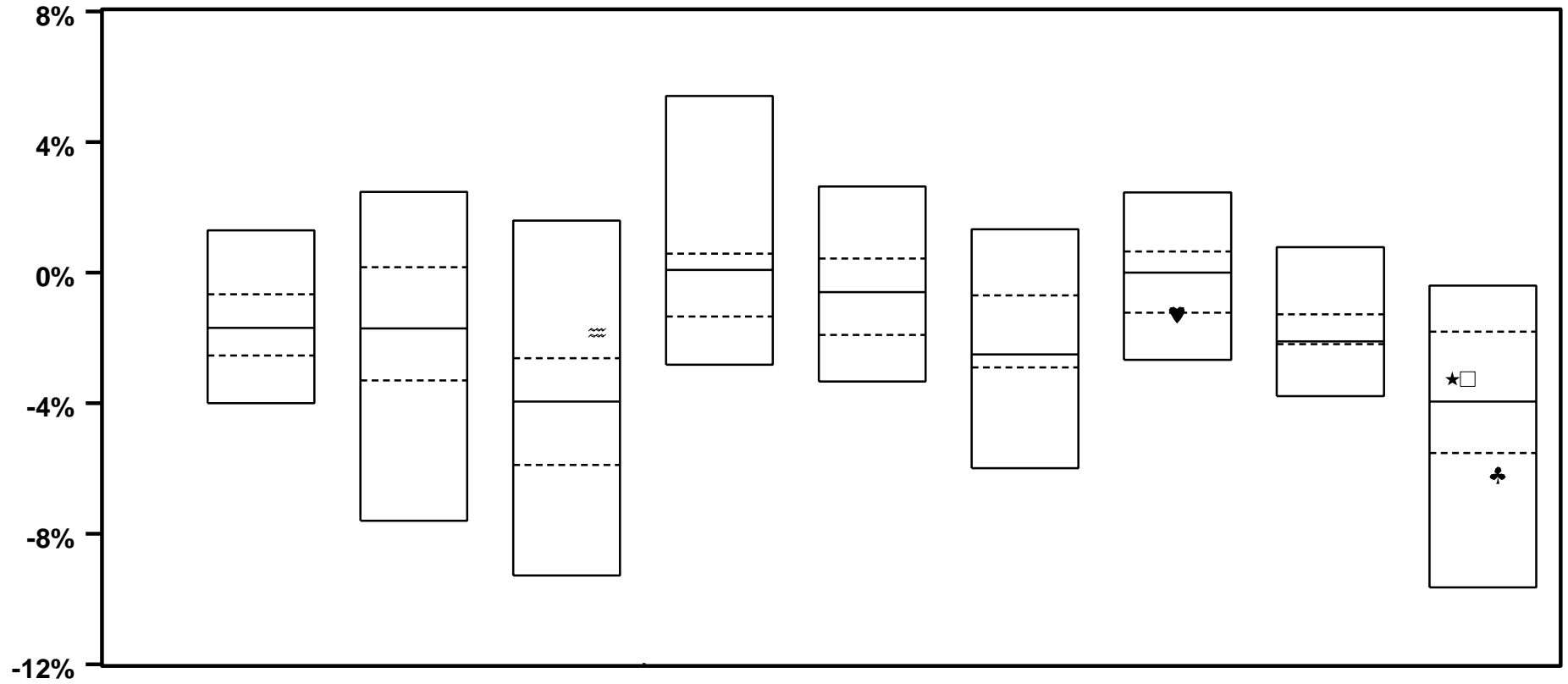

	SMALL VALUE	SMALL CORE	SMALL GROWTH	MEDIUM VALUE	MEDIUM CORE	MEDIUM GROWTH	LARGE VALUE	LARGE CORE	LARGE GROWTH
★ MUNI COMPOSITE									- 3.3 42
□ EQTY COMPOSITE									- 3.3 42
♥ DELAWARE							- 1.3 76		
♣ ALLIANCE									- 6.2 79
≡ LAZARD			- 1.8 16						
MEDIAN	- 1.7	- 1.7	- 4.0	0.1	- 0.6	- 2.5	0.0	- 2.1	- 4.0

VERMONT MUNICIPAL EMPLOYEES

EQUITY MANAGER SPECTRUM STYLE ANALYSIS - EQUITY ONLY RETURNS

YEAR ENDING 3/05

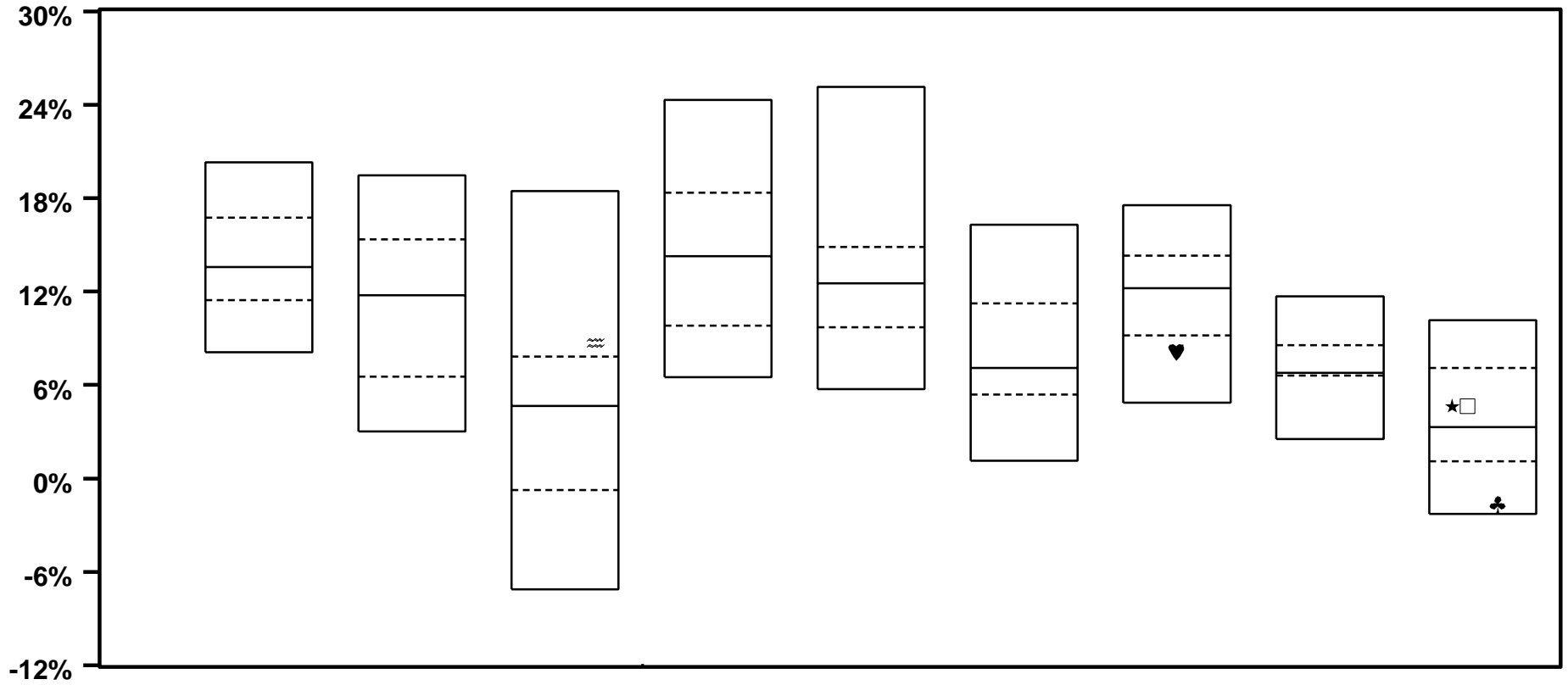

	SMALL VALUE	SMALL CORE	SMALL GROWTH	MEDIUM VALUE	MEDIUM CORE	MEDIUM GROWTH	LARGE VALUE	LARGE CORE	LARGE GROWTH
★ MUNI COMPOSITE									4.6 39
□ EQTY COMPOSITE									4.6 39
♥ DELAWARE							8.2 82		
♣ ALLIANCE									- 1.7 93
≈ LAZARD			8.7 21						
MEDIAN	13.6	11.8	4.6	14.3	12.5	7.1	12.2	6.8	3.3

VERMONT MUNICIPAL EMPLOYEES

EQUITY MANAGER SPECTRUM STYLE ANALYSIS - EQUITY ONLY RETURNS

TWO YEARS ENDING 3/05

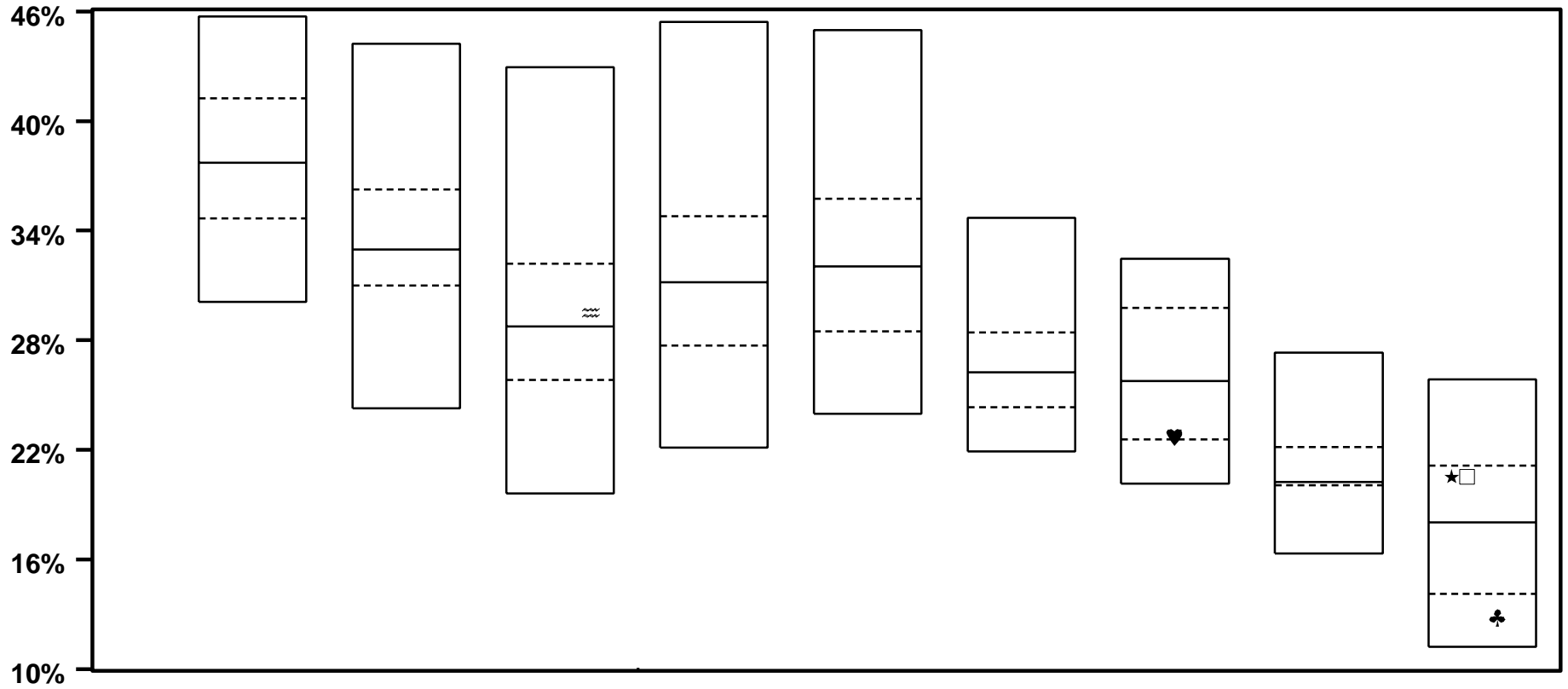

	SMALL VALUE	SMALL CORE	SMALL GROWTH	MEDIUM VALUE	MEDIUM CORE	MEDIUM GROWTH	LARGE VALUE	LARGE CORE	LARGE GROWTH
★ MUNI COMPOSITE									20.5 32
□ EQTY COMPOSITE									20.5 32
♥ DELAWARE							22.7 74		
♣ ALLIANCE									12.8 85
≈ LAZARD			29.5 45						
MEDIAN	37.7	33.0	28.8	31.2	32.0	26.3	25.8	20.2	18.0

VERMONT MUNICIPAL EMPLOYEES

EQUITY MANAGER SPECTRUM STYLE ANALYSIS - EQUITY ONLY RETURNS

THREE YEARS ENDING 3/05

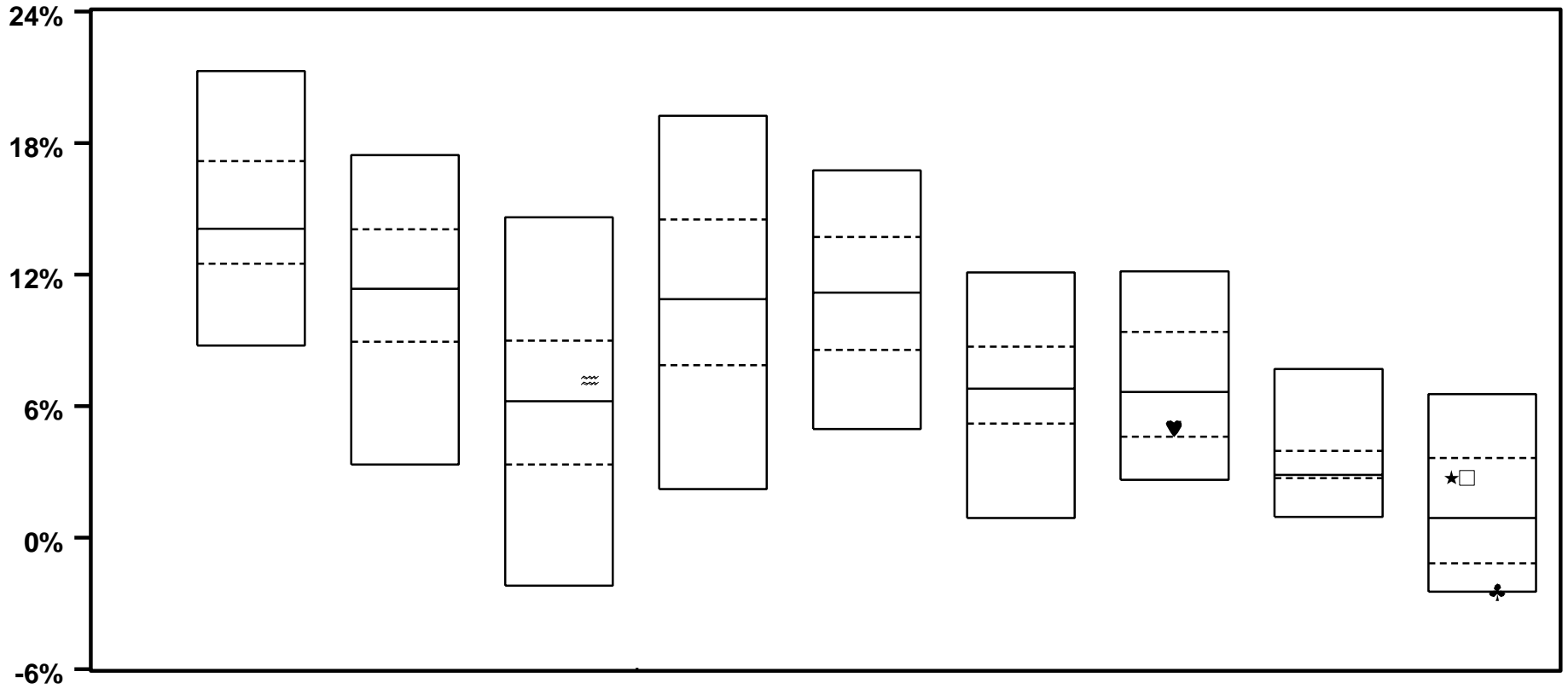

	SMALL VALUE	SMALL CORE	SMALL GROWTH	MEDIUM VALUE	MEDIUM CORE	MEDIUM GROWTH	LARGE VALUE	LARGE CORE	LARGE GROWTH
★ MUNI COMPOSITE									2.7 38
□ EQTY COMPOSITE									2.7 38
♥ DELAWARE							5.0 70		
♣ ALLIANCE									-2.5 95
≡ LAZARD			7.2 43						
MEDIAN	14.1	11.3	6.2	10.9	11.2	6.8	6.7	2.9	0.9

VERMONT MUNICIPAL EMPLOYEES

EQUITY MANAGER SPECTRUM STYLE ANALYSIS - EQUITY ONLY RETURNS

FOUR YEARS ENDING 3/05

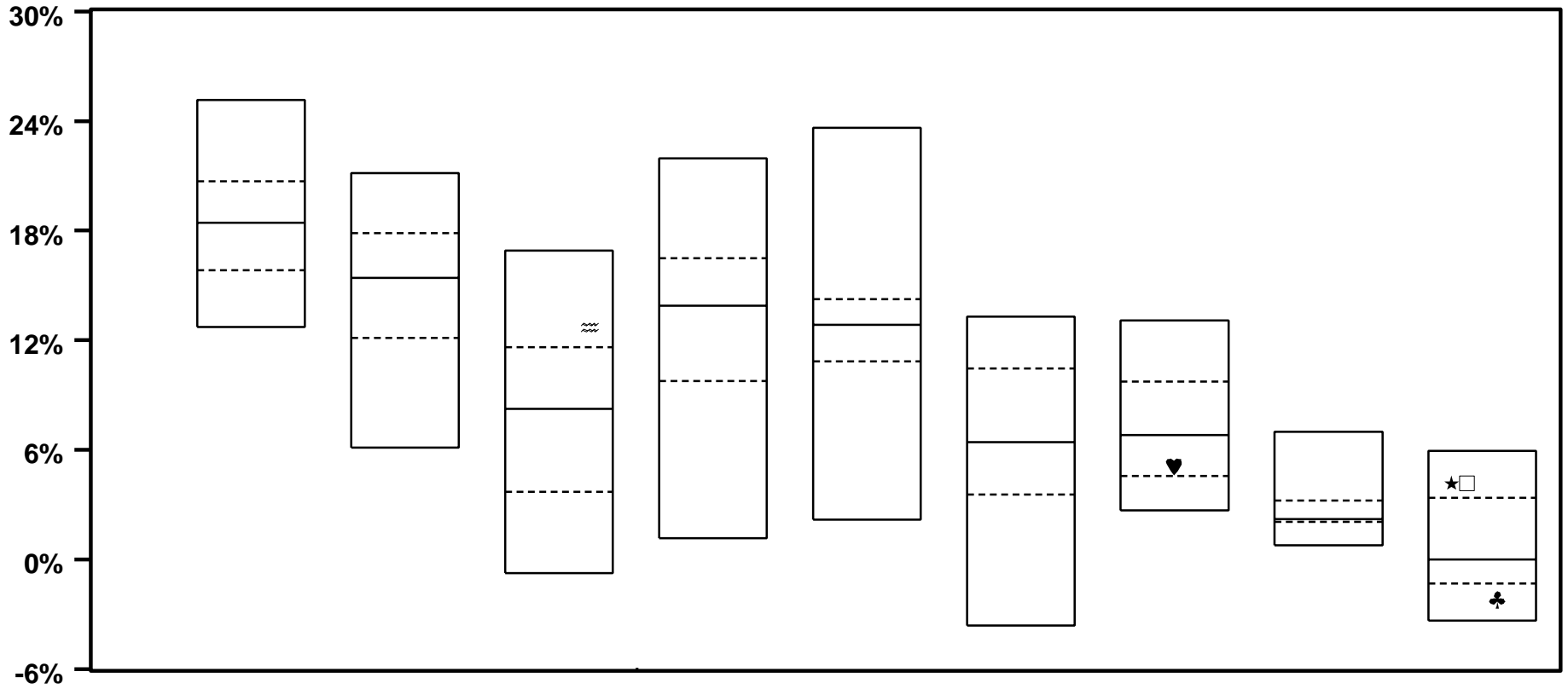

	SMALL VALUE	SMALL CORE	SMALL GROWTH	MEDIUM VALUE	MEDIUM CORE	MEDIUM GROWTH	LARGE VALUE	LARGE CORE	LARGE GROWTH
★ MUNI COMPOSITE									4.2 16
□ EQTY COMPOSITE									4.2 16
♥ DELAWARE							5.1 71		
♣ ALLIANCE									- 2.2 85
≈ LAZARD			12.7 19						
MEDIAN	18.4	15.4	8.3	13.9	12.8	6.4	6.8	2.2	0.0

VERMONT MUNICIPAL EMPLOYEES

EQUITY MANAGER SPECTRUM STYLE ANALYSIS - EQUITY ONLY RETURNS

FIVE YEARS ENDING 3/05

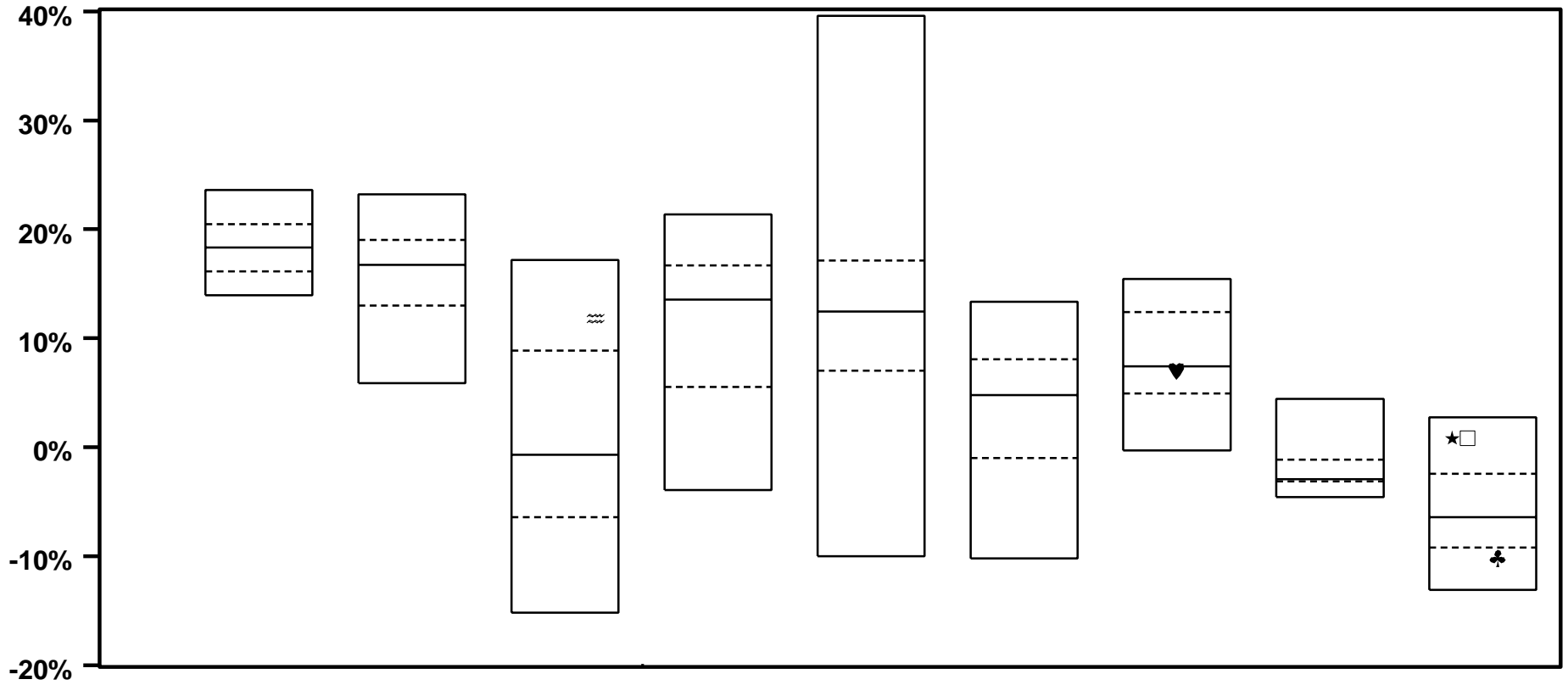

	SMALL VALUE	SMALL CORE	SMALL GROWTH	MEDIUM VALUE	MEDIUM CORE	MEDIUM GROWTH	LARGE VALUE	LARGE CORE	LARGE GROWTH
★ MUNI COMPOSITE									0.8 11
□ EQTY COMPOSITE									0.8 11
♥ DELAWARE							7.0 55		
♣ ALLIANCE									-10.1 80
≈ LAZARD			11.8 18						
MEDIAN	18.3	16.7	-0.7	13.6	12.5	4.8	7.4	-3.0	-6.4

VERMONT MUNICIPAL EMPLOYEES

EQUITY MANAGER SPECTRUM STYLE ANALYSIS - EQUITY ONLY RETURNS

YEAR ENDING 3/04

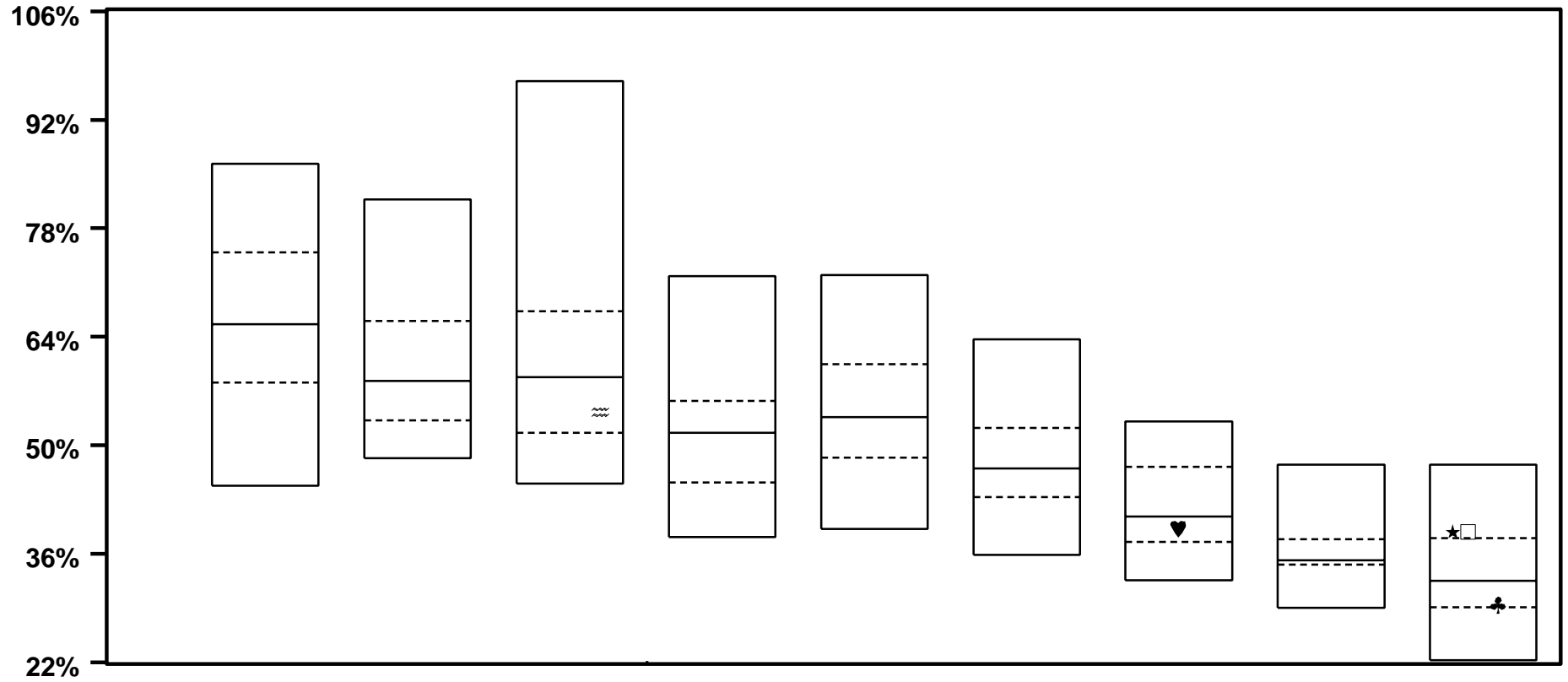

	SMALL VALUE	SMALL CORE	SMALL GROWTH	MEDIUM VALUE	MEDIUM CORE	MEDIUM GROWTH	LARGE VALUE	LARGE CORE	LARGE GROWTH
★ MUNI COMPOSITE									38.9 22
□ EQTY COMPOSITE									38.9 22
♥ DELAWARE							39.3 60		
♣ ALLIANCE									29.4 71
≈ LAZARD			54.3 63						
MEDIAN	65.6	58.3	58.8	51.6	53.6	47.0	40.8	35.2	32.5

VERMONT MUNICIPAL EMPLOYEES

EQUITY MANAGER SPECTRUM STYLE ANALYSIS - EQUITY ONLY RETURNS

YEAR ENDING 3/03

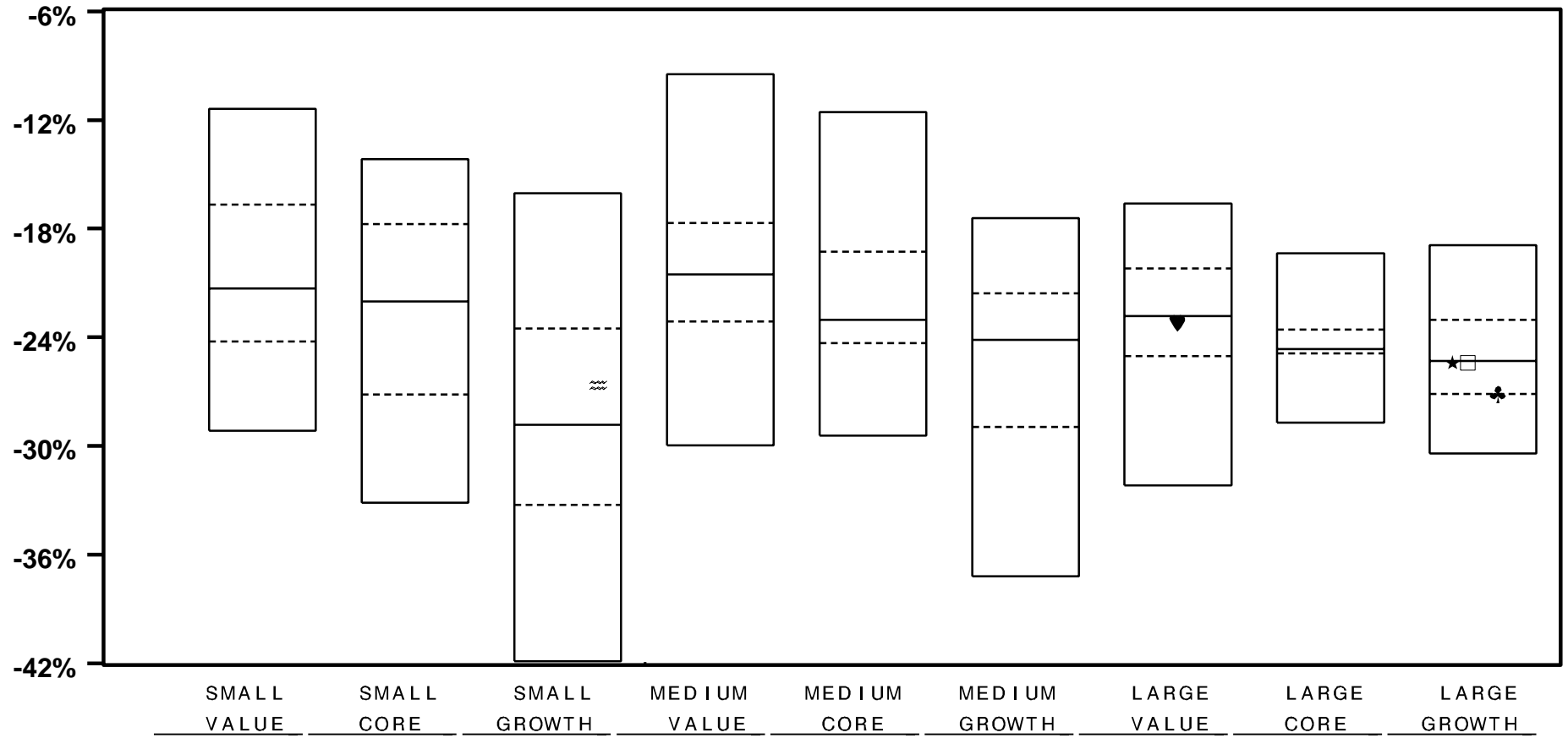

★ MUNI COMPOSITE										- 25.4	51
□ EQTY COMPOSITE										- 25.4	51
♥ DELAWARE										- 23.2	55
♣ ALLIANCE										- 27.1	75
≈ LAZARD										- 26.6	37
MEDIAN	- 21.3	- 22.0	- 28.8	- 20.5	- 23.0	- 24.1	- 22.8	- 24.7	- 25.3		

VERMONT MUNICIPAL EMPLOYEES

EQUITY MANAGER SPECTRUM STYLE ANALYSIS - EQUITY ONLY RETURNS

YEAR ENDING 3/02

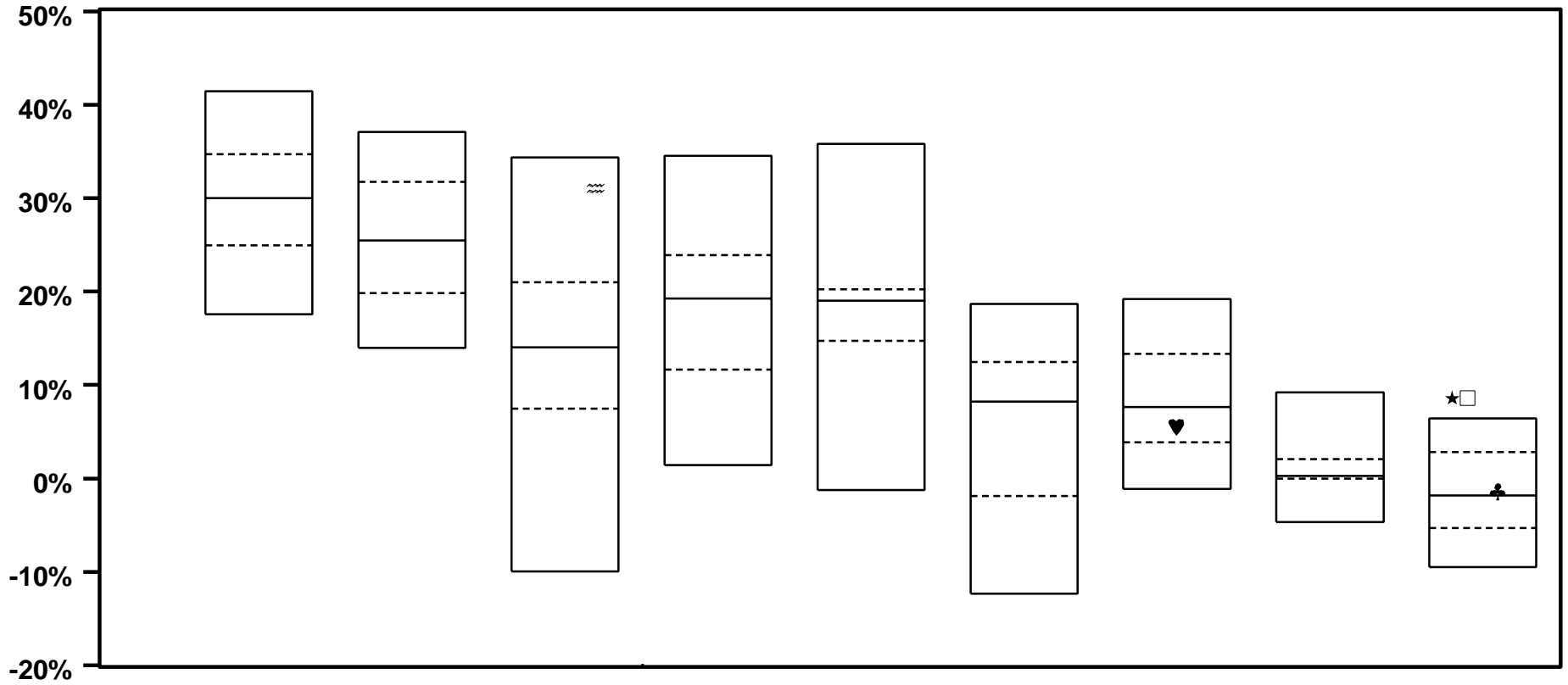

	SMALL VALUE	SMALL CORE	SMALL GROWTH	MEDIUM VALUE	MEDIUM CORE	MEDIUM GROWTH	LARGE VALUE	LARGE CORE	LARGE GROWTH
★ MUNI COMPOSITE									8.6 2
□ EQTY COMPOSITE									8.6 2
♥ DELAWARE							5.5 60		
♣ ALLIANCE									- 1.4 46
≈ LAZARD			31.1 7						
MEDIAN	30.0	25.5	14.0	19.3	19.0	8.2	7.6	0.3	- 1.8

VERMONT MUNICIPAL EMPLOYEES

EQUITY MANAGER SPECTRUM STYLE ANALYSIS - EQUITY ONLY RETURNS

YEAR ENDING 3/01

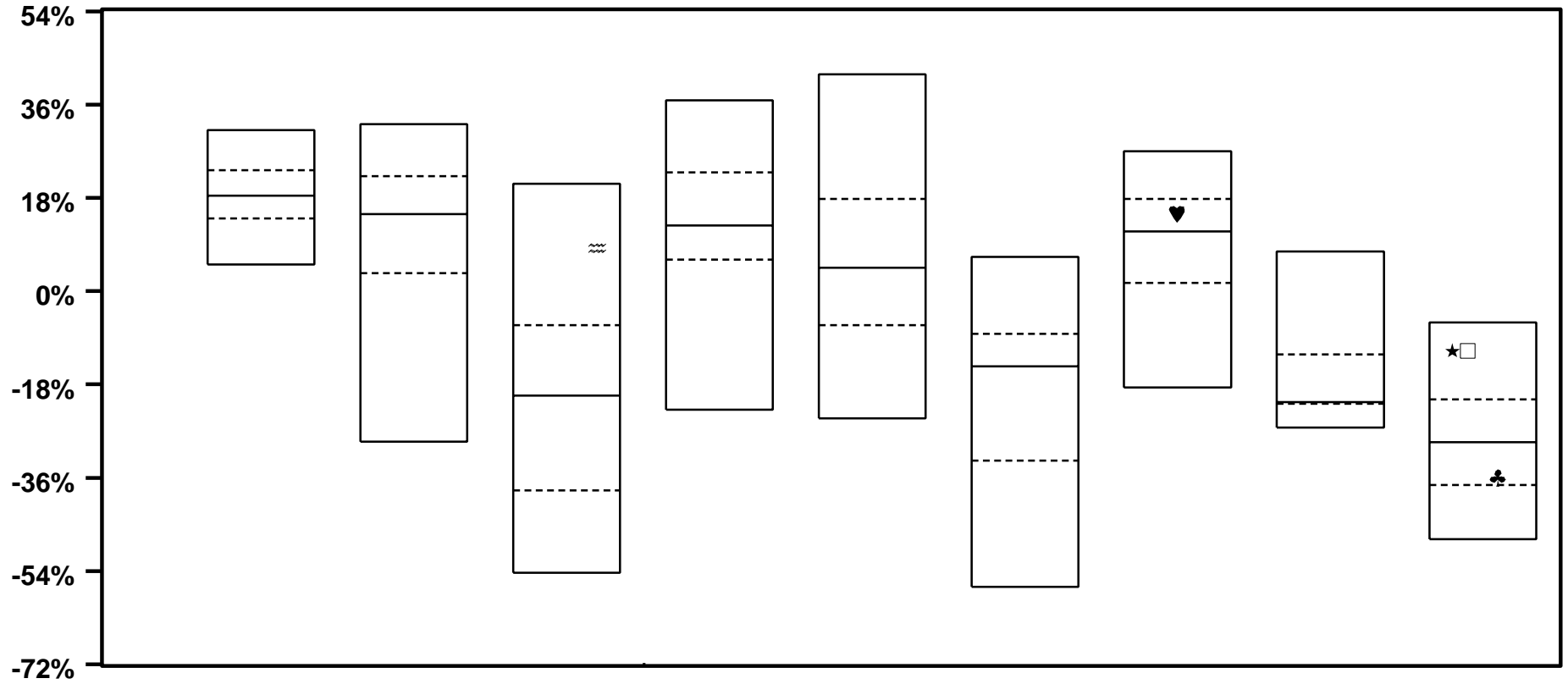

	SMALL VALUE	SMALL CORE	SMALL GROWTH	MEDIUM VALUE	MEDIUM CORE	MEDIUM GROWTH	LARGE VALUE	LARGE CORE	LARGE GROWTH
★ MUNI COMPOSITE									- 11.5 10
□ EQTY COMPOSITE									- 11.5 10
♥ DELAWARE							14.9 40		
♣ ALLIANCE									- 36.0 69
≈ LAZARD			8.3 16						
MEDIAN	18.4	14.8	- 20.1	12.7	4.6	- 14.5	11.6	- 21.5	- 29.2

VERMONT MUNICIPAL EMPLOYEES

EQUITY MANAGER SPECTRUM STYLE ANALYSIS - EQUITY ONLY RETURNS

YEAR ENDING 3/00

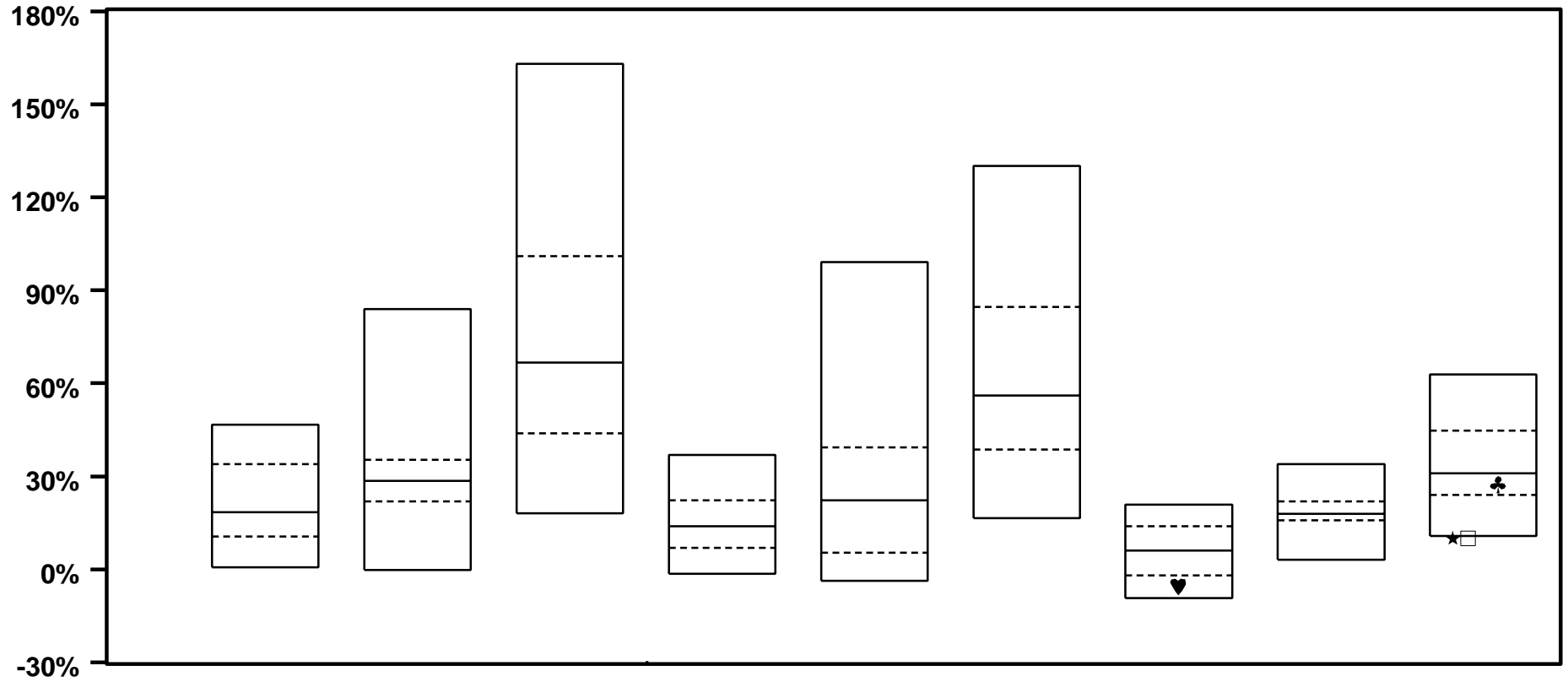

	SMALL VALUE	SMALL CORE	SMALL GROWTH	MEDIUM VALUE	MEDIUM CORE	MEDIUM GROWTH	LARGE VALUE	LARGE CORE	LARGE GROWTH
★ MUNI COMPOSITE									10.1 96
□ EQTY COMPOSITE									10.1 96
♥ DELAWARE							- 5.4 83		
♣ ALLIANCE									27.5 63
MEDIAN	18.4	28.5	66.6	13.8	22.2	56.0	6.1	18.0	30.9

VERMONT MUNICIPAL EMPLOYEES

EQUITY STYLE SPECTRUM ANALYSIS

AS OF 3/05

(MOVEMENT OVER PAST TWO YEARS)

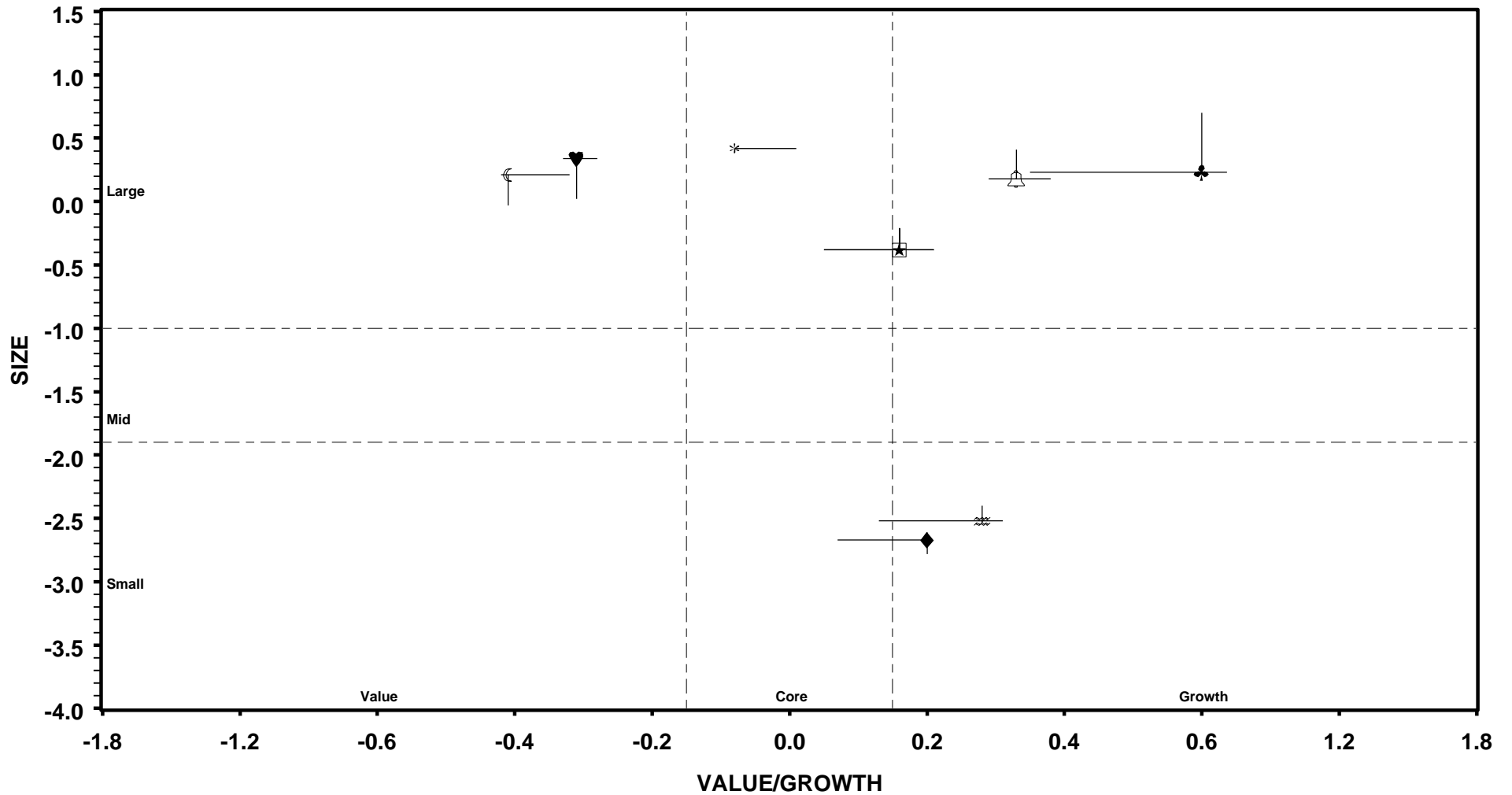

★ MUNI COMPOSITE □ EQTY COMPOSITE ♥ DELAWARE ♣ ALLIANCE ≡ LAZARD
 * S&P 500 🔔 R 1000(R) GR Ⓒ R 1000(R) VALUE ◆ R 2000(R)

VERMONT MUNICIPAL EMPLOYEES

EQUITY STYLE SPECTRUM ANALYSIS

CURRENT DISTRIBUTION AND PORTFOLIO HISTORY

AS OF 3/05

MUNICIPAL SYSTEM COMPOSITE

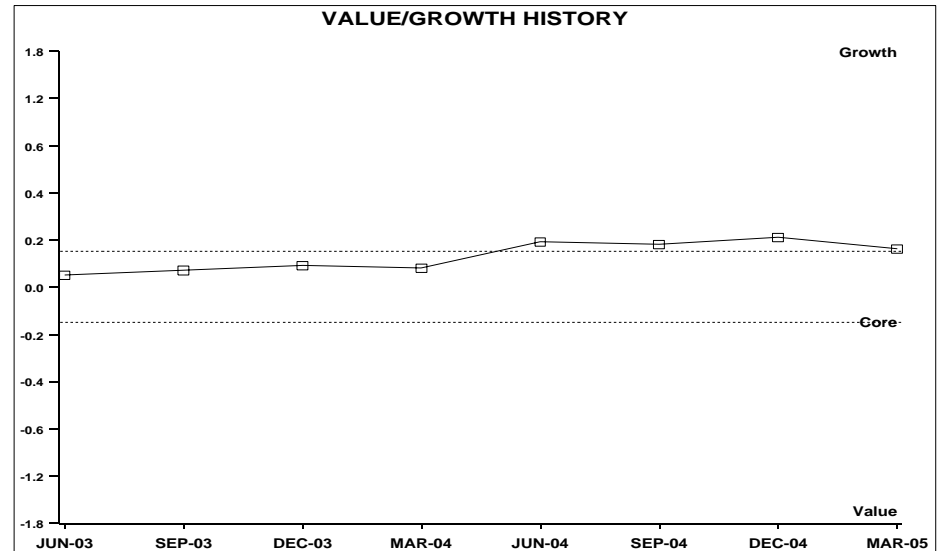
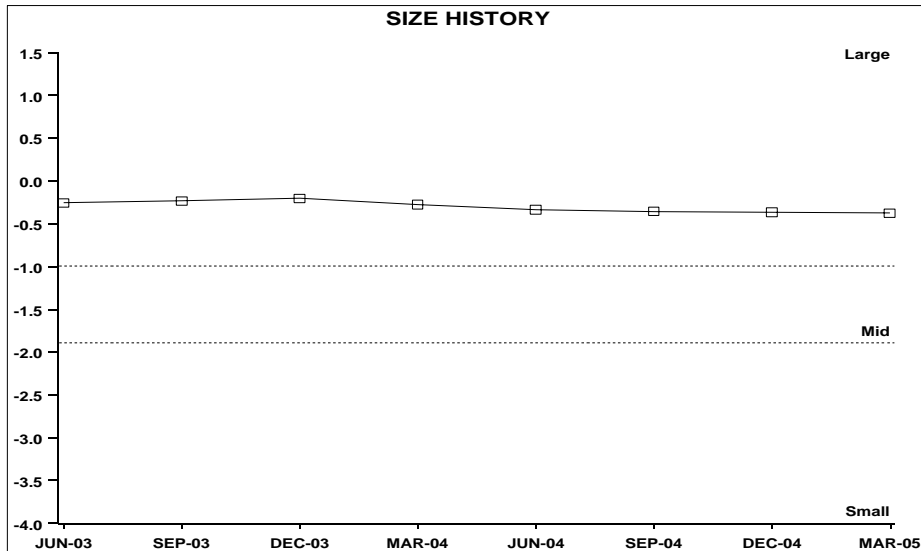
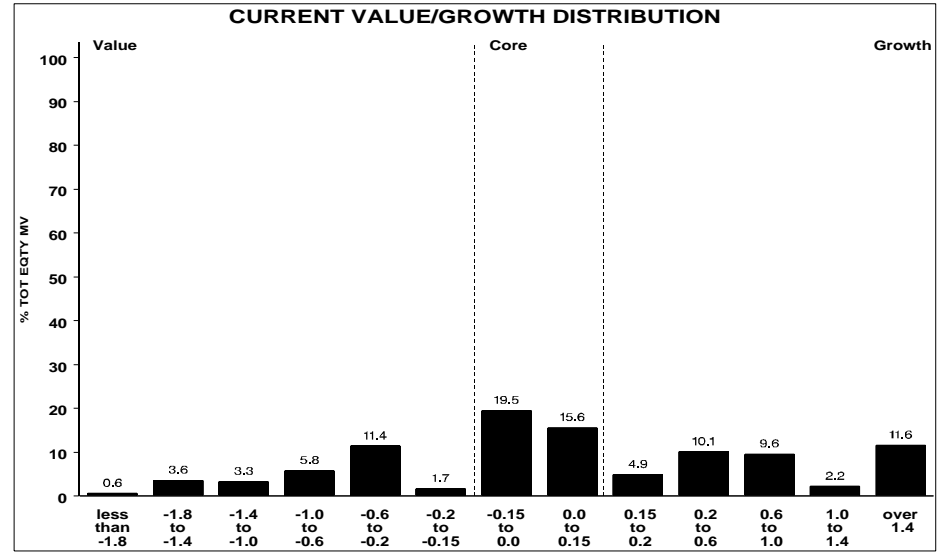
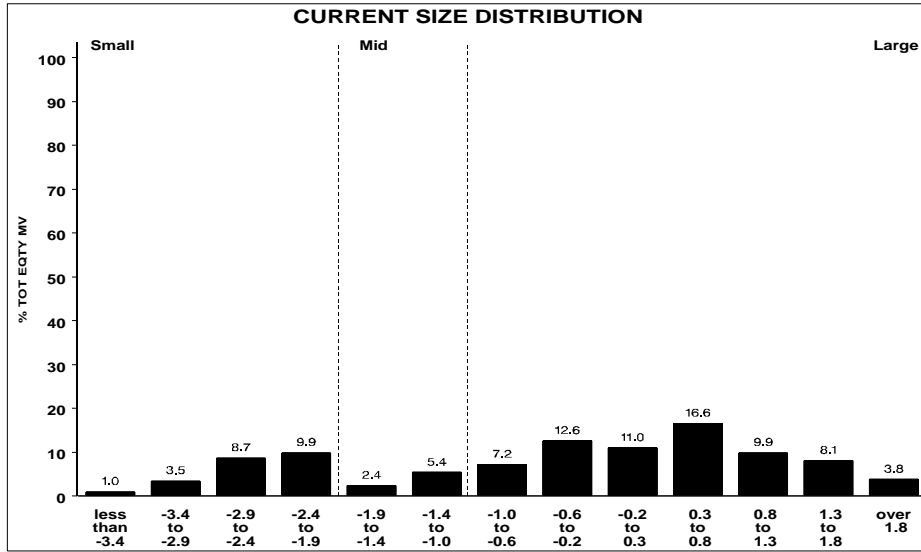

VERMONT MUNICIPAL EMPLOYEES

EQUITY STYLE SPECTRUM ANALYSIS

CURRENT DISTRIBUTION AND PORTFOLIO HISTORY

AS OF 3/05

DOMESTIC EQUITY COMPOSITE

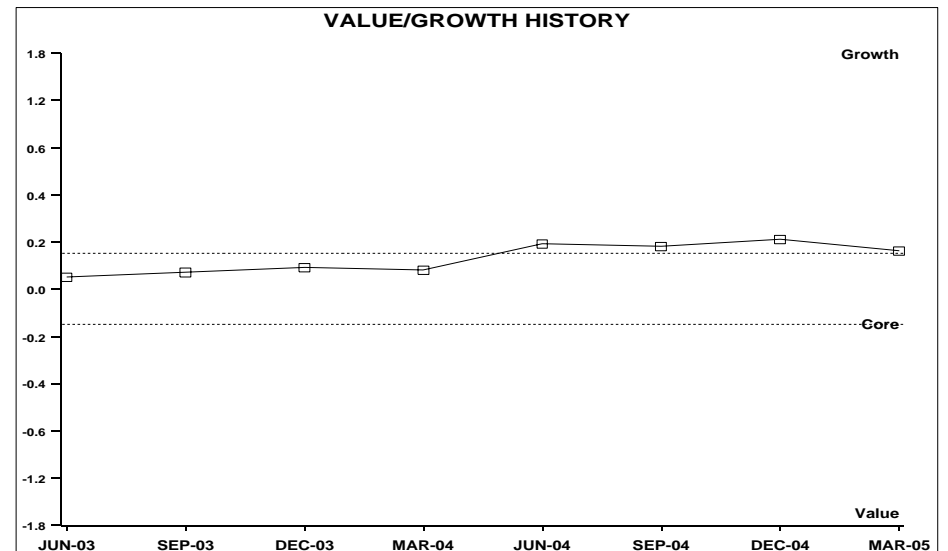
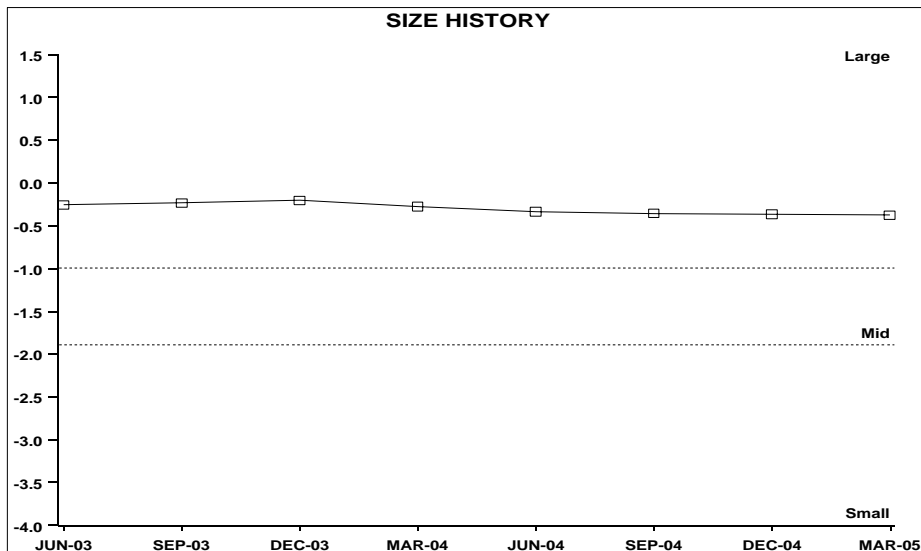
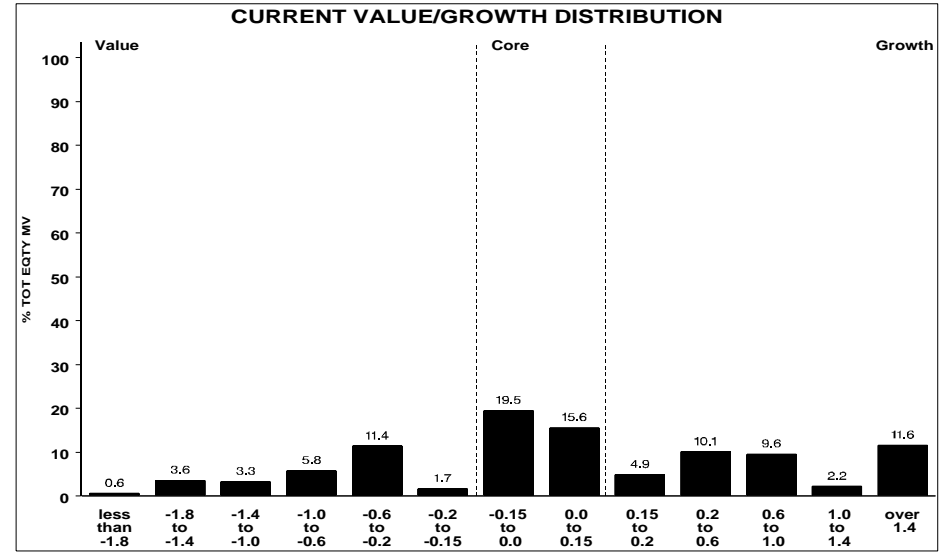
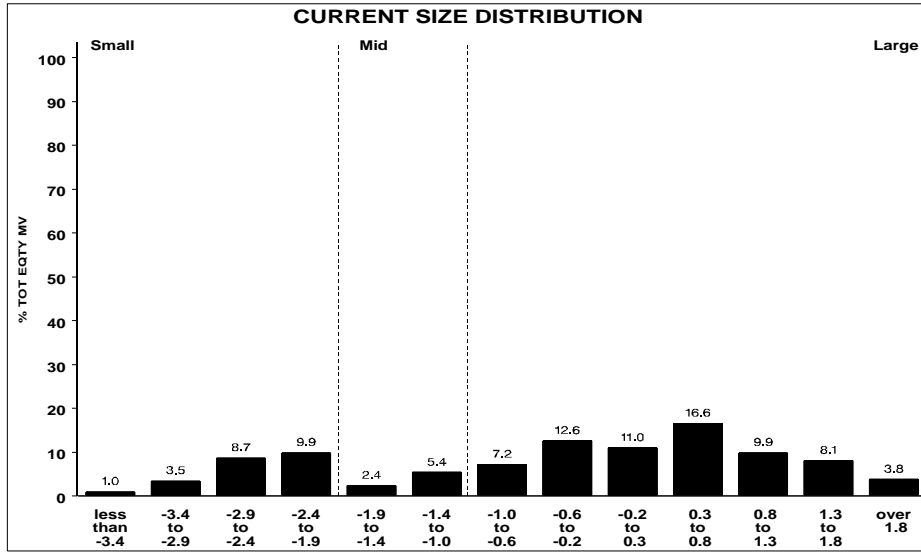

VERMONT MUNICIPAL EMPLOYEES

EQUITY STYLE SPECTRUM ANALYSIS

CURRENT DISTRIBUTION AND PORTFOLIO HISTORY

AS OF 3/05

DELAWARE

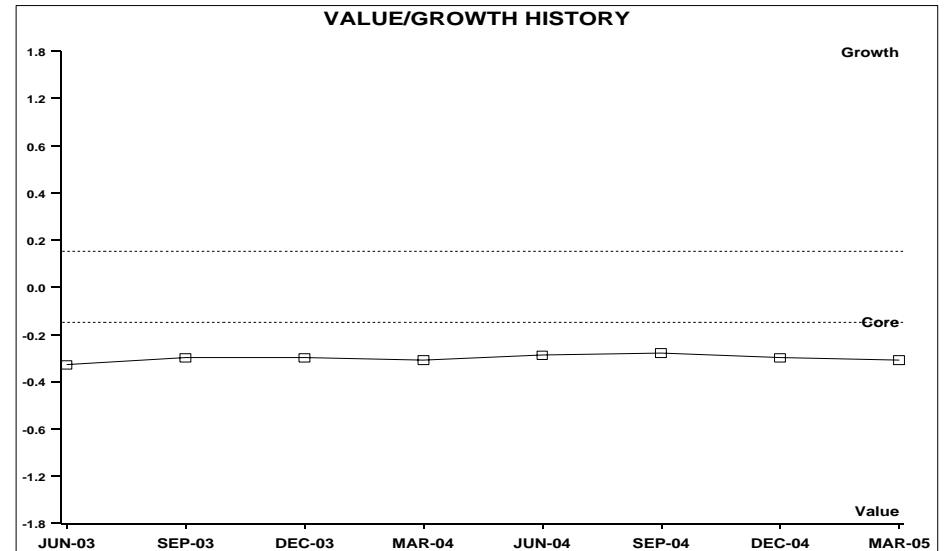
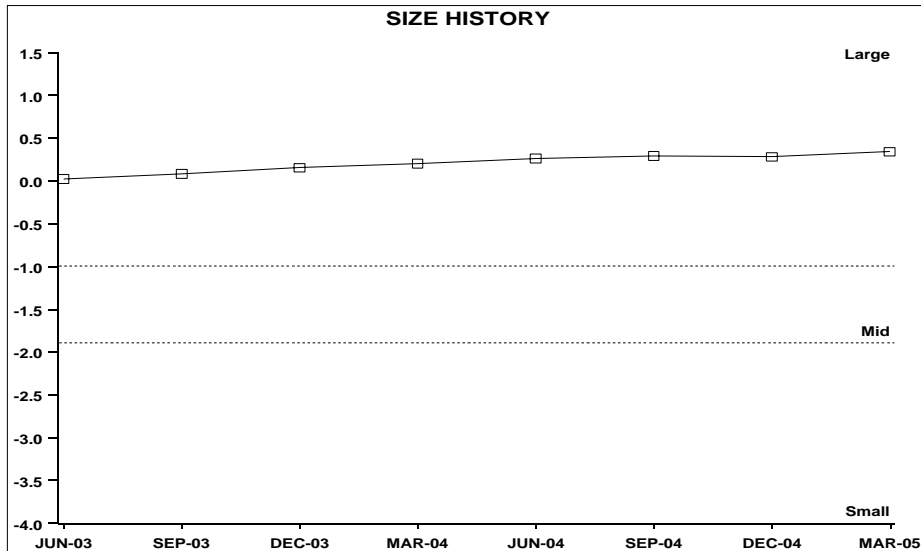
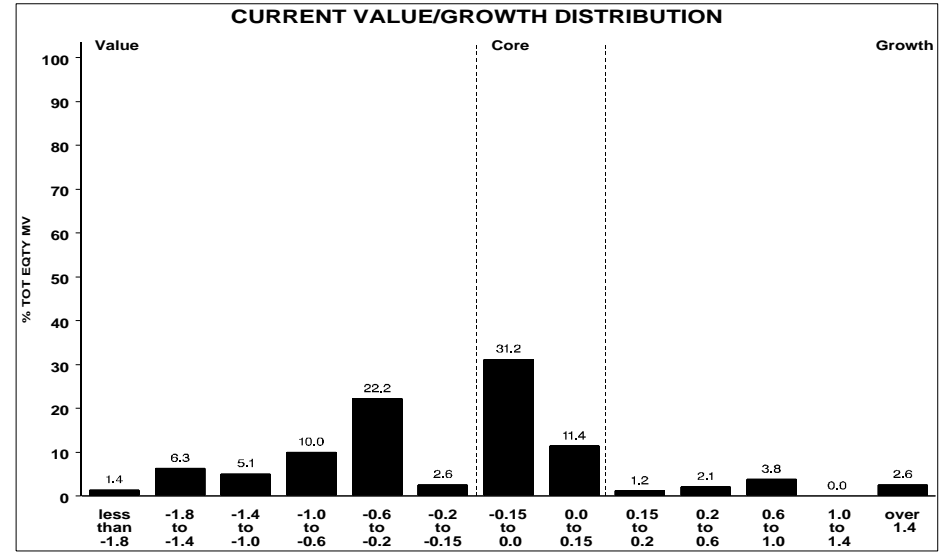
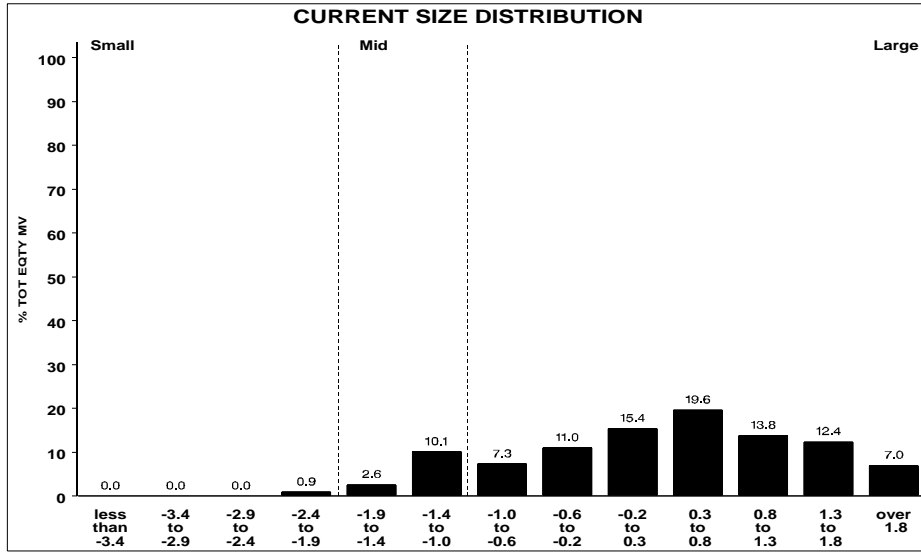

VERMONT MUNICIPAL EMPLOYEES

EQUITY STYLE SPECTRUM ANALYSIS

CURRENT DISTRIBUTION AND PORTFOLIO HISTORY

AS OF 3/05

ALLIANCE LARGE CAP GROWTH FUND

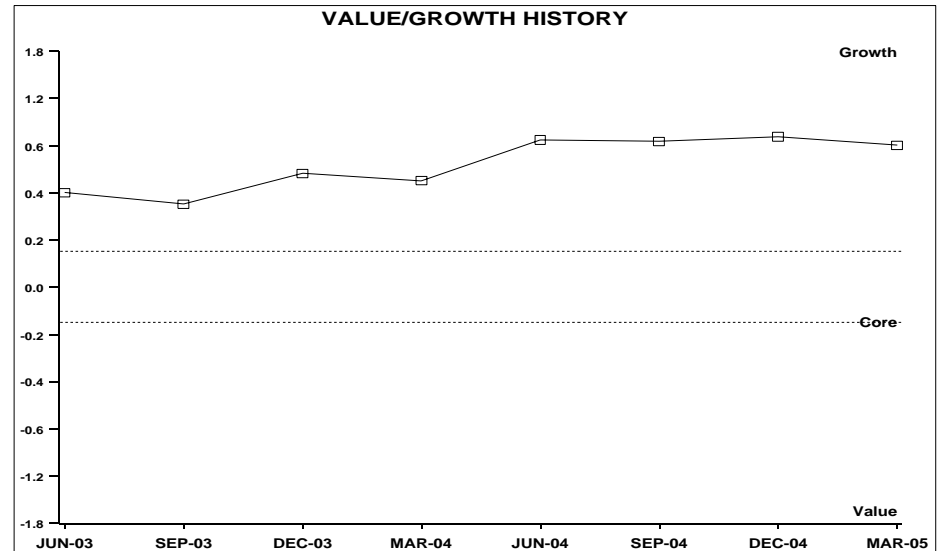
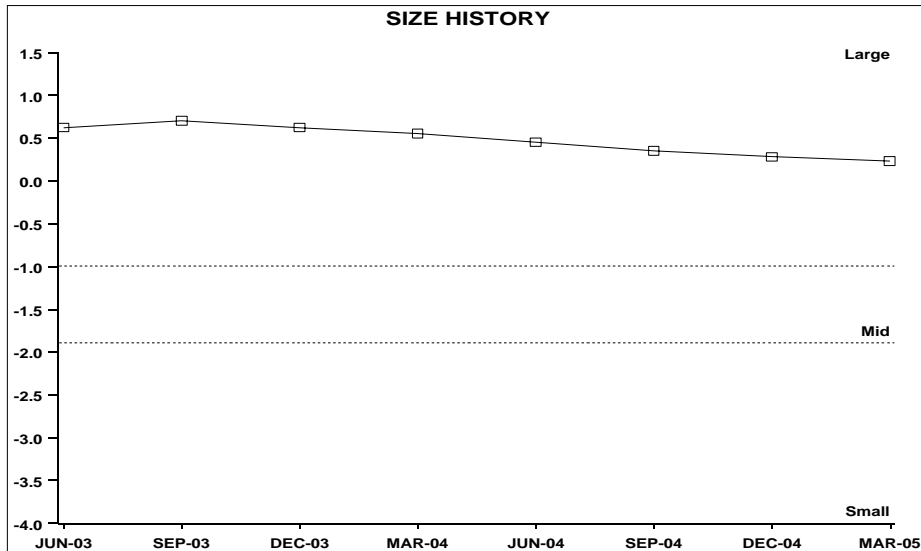
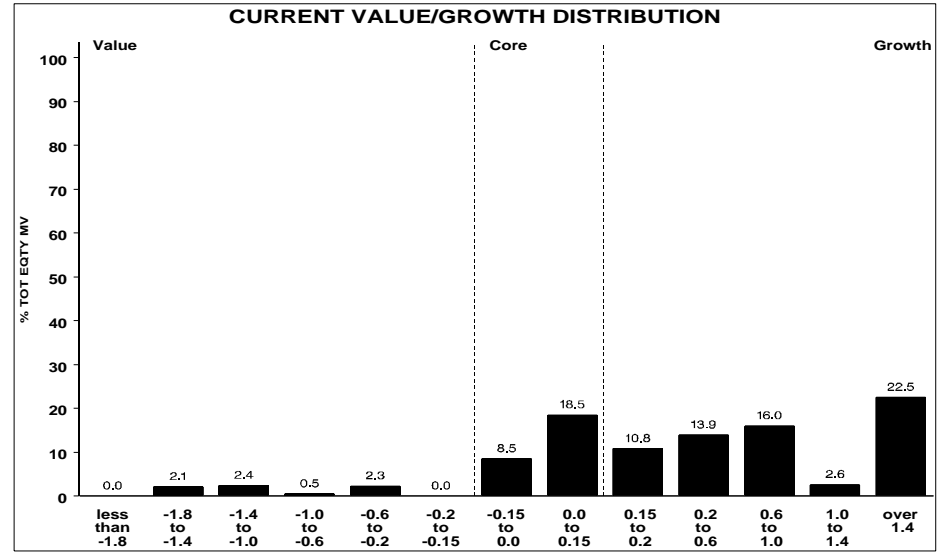
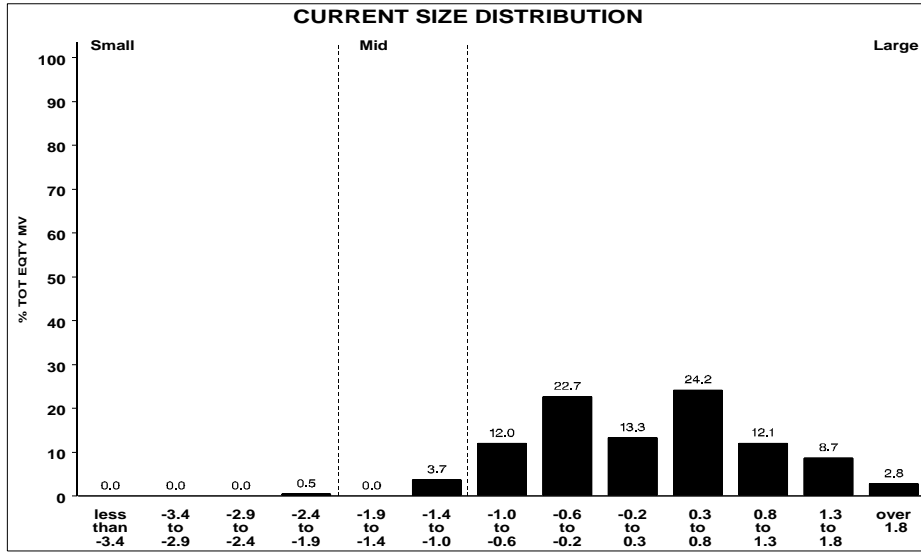

VERMONT MUNICIPAL EMPLOYEES

EQUITY STYLE SPECTRUM ANALYSIS

CURRENT DISTRIBUTION AND PORTFOLIO HISTORY

AS OF 3/05

LAZARD SMALL CAP FUND

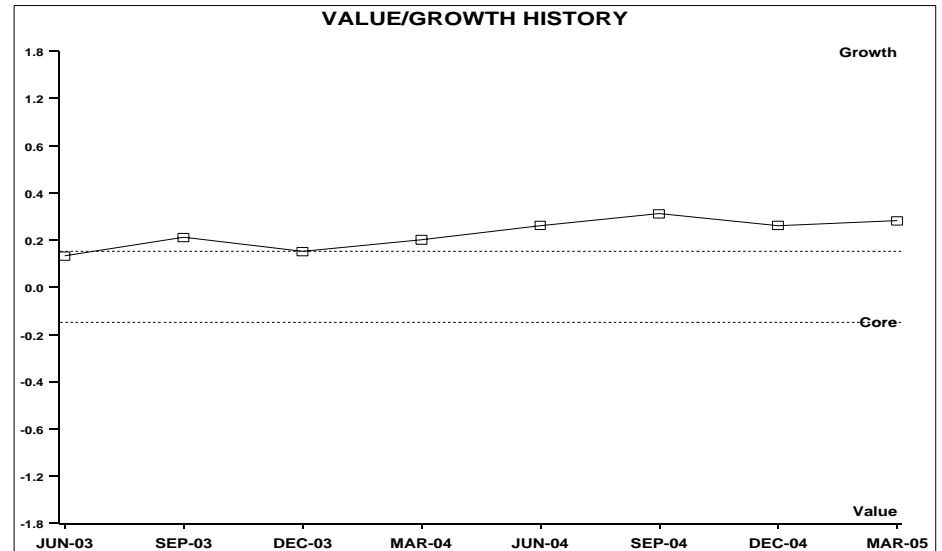
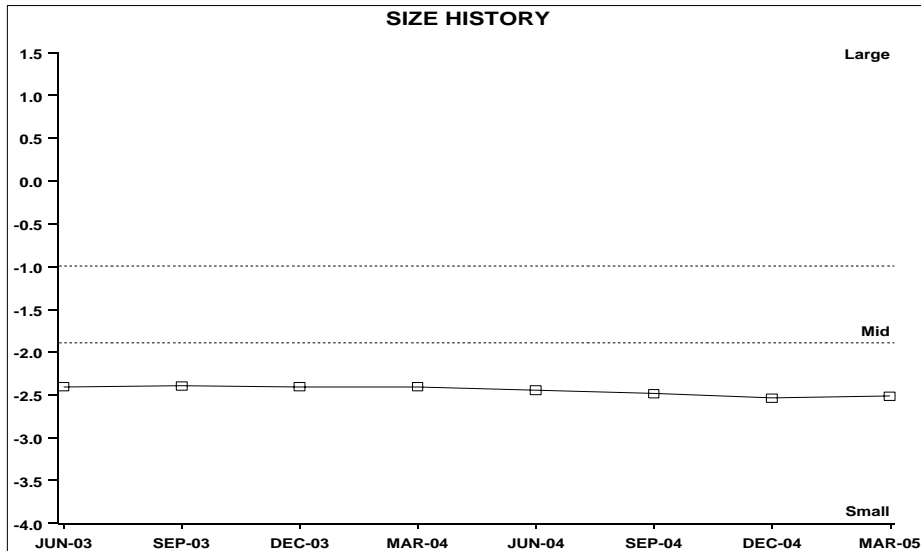
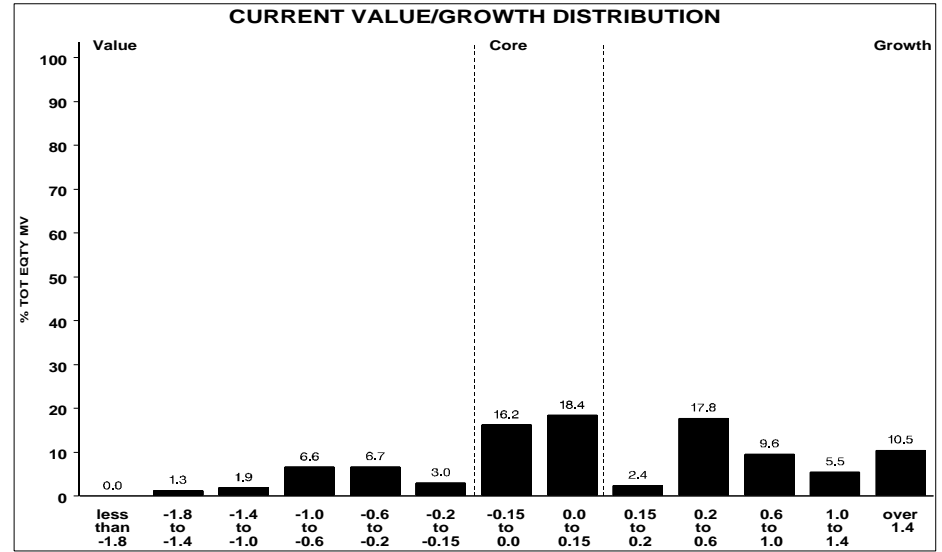
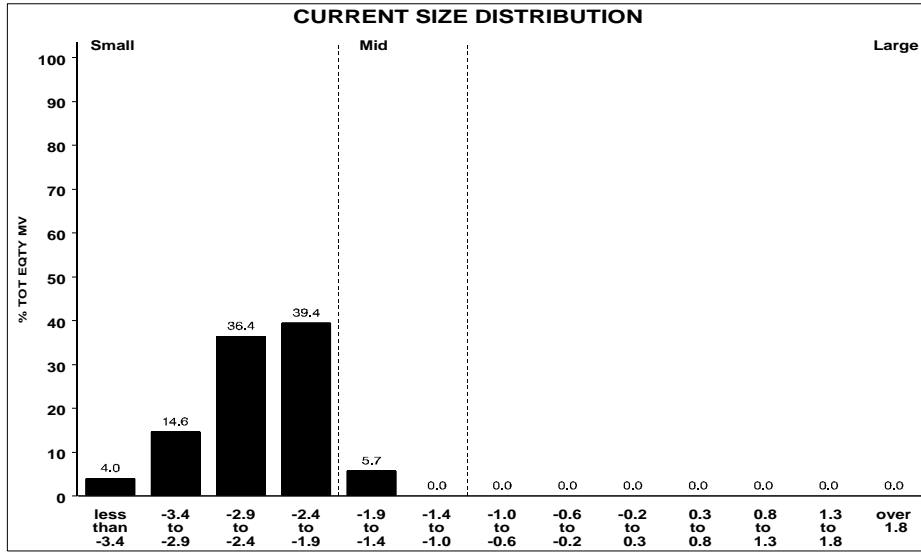

VERMONT MUNICIPAL EMPLOYEES

INT'L DEVELOPED MKT EQUITY MANAGER STYLE ANALYSIS - TOTAL RETURNS

QUARTER ENDING 3/05

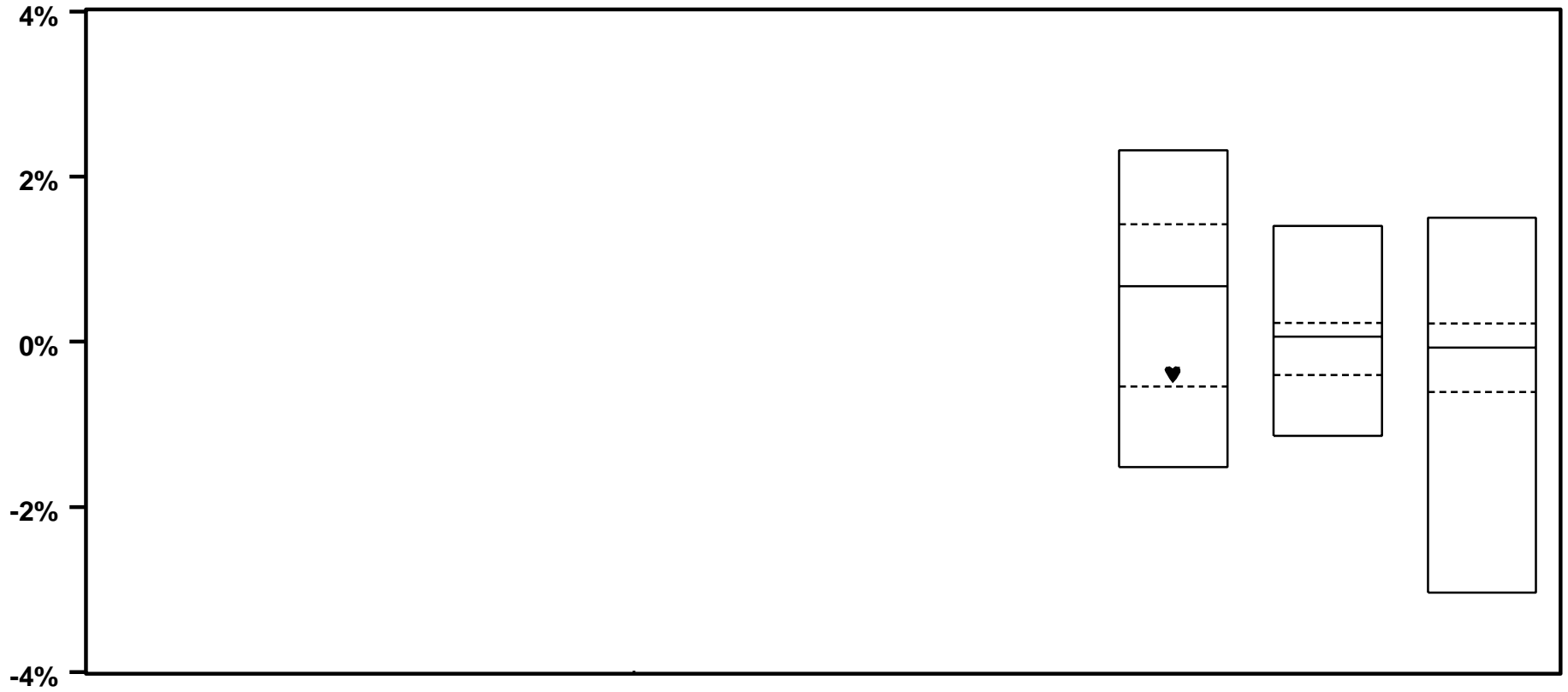

	LARGE VALUE	LARGE CORE	LARGE GROWTH
♥ UBS	- 0.4		
MEDIAN	0.7	0.1	- 0.1

VERMONT MUNICIPAL EMPLOYEES

INT'L DEVELOPED MKT EQUITY MANAGER STYLE ANALYSIS - TOTAL RETURNS

YEAR ENDING 3/05

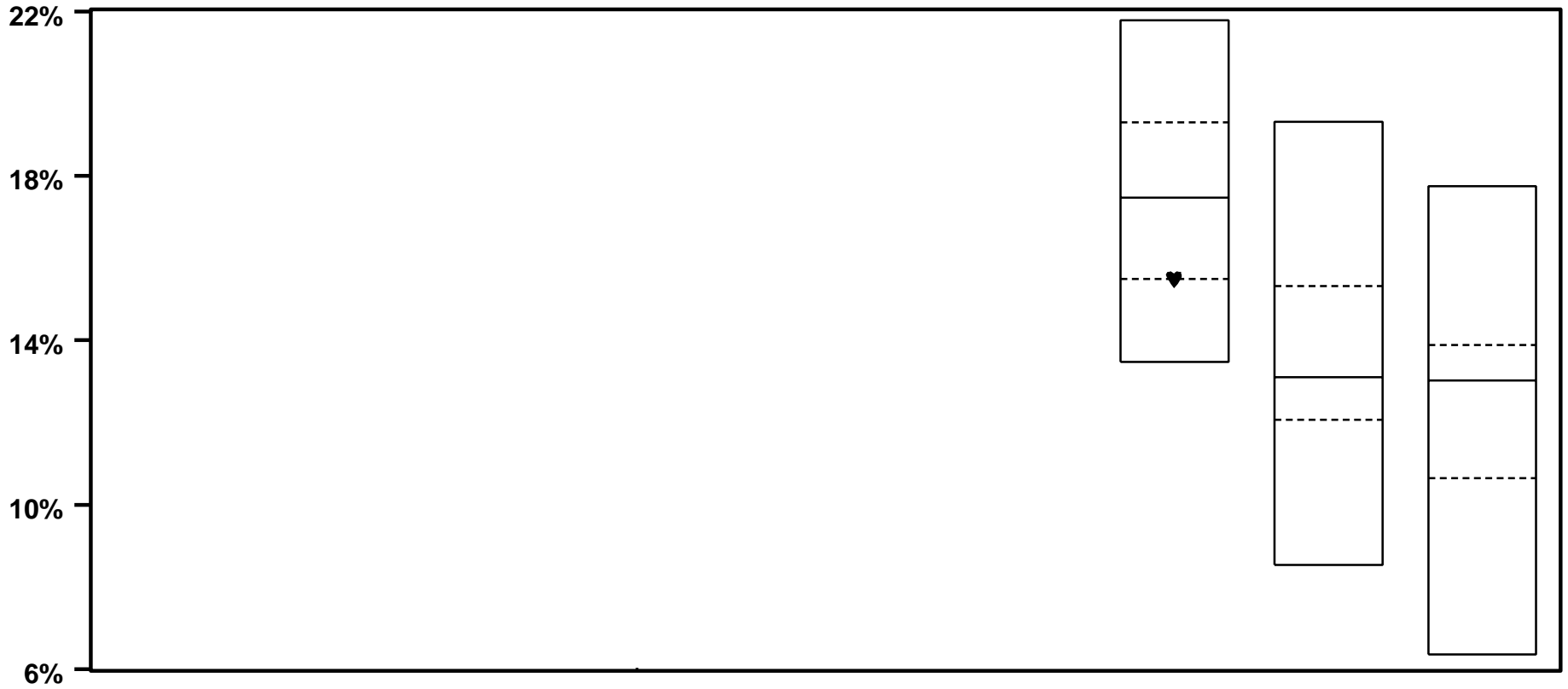

	LARGE VALUE		LARGE CORE	LARGE GROWTH
♥ UBS	15.5	75		
MEDIAN	17.5		13.1	13.0

VERMONT MUNICIPAL EMPLOYEES

INT'L DEVELOPED MKT EQUITY MANAGER STYLE ANALYSIS - TOTAL RETURNS

TWO YEARS ENDING 3/05

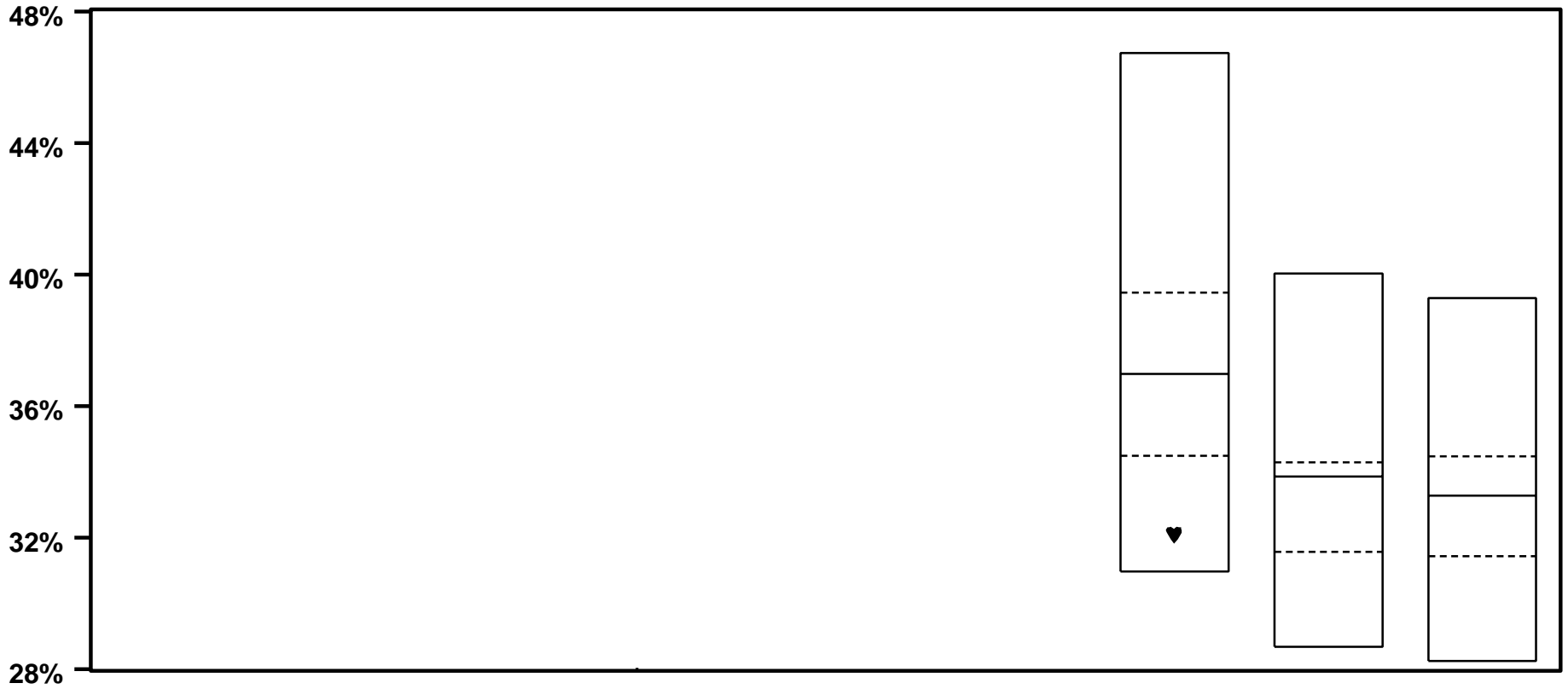

	LARGE VALUE	LARGE CORE	LARGE GROWTH
♥ UBS	32.1		
MEDIAN	37.0	33.9	33.3

VERMONT MUNICIPAL EMPLOYEES

INT'L DEVELOPED MKT EQUITY MANAGER STYLE ANALYSIS - TOTAL RETURNS

THREE YEARS ENDING 3/05

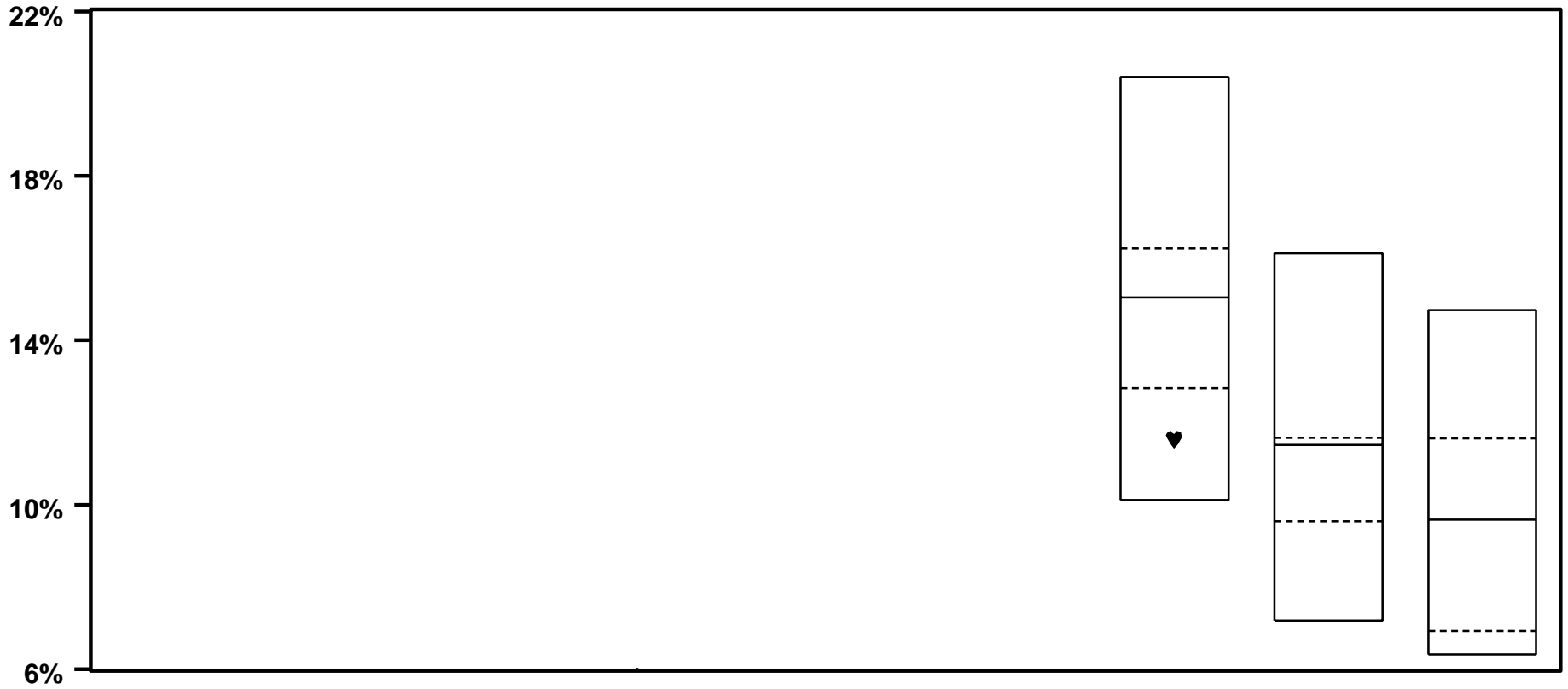

	LARGE VALUE	LARGE CORE	LARGE GROWTH
♥ UBS	11.6		
MEDIAN	15.0	11.5	9.6

VERMONT MUNICIPAL EMPLOYEES

INT'L DEVELOPED MKT EQUITY MANAGER STYLE ANALYSIS - TOTAL RETURNS

FOUR YEARS ENDING 3/05

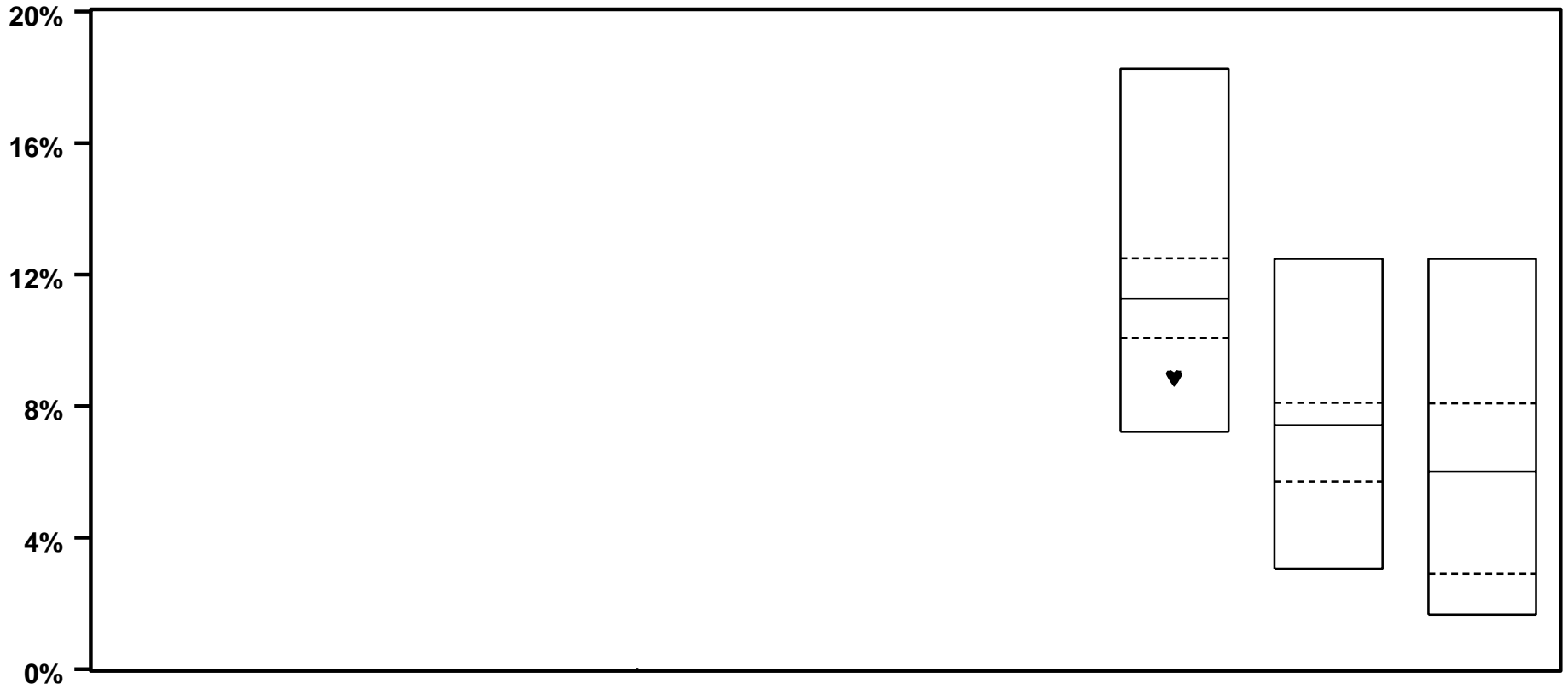

	LARGE VALUE	LARGE CORE	LARGE GROWTH
♥ UBS	8.9		
MEDIAN	11.3	7.4	6.0

VERMONT MUNICIPAL EMPLOYEES

INT'L DEVELOPED MKT EQUITY MANAGER STYLE ANALYSIS - TOTAL RETURNS

FIVE YEARS ENDING 3/05

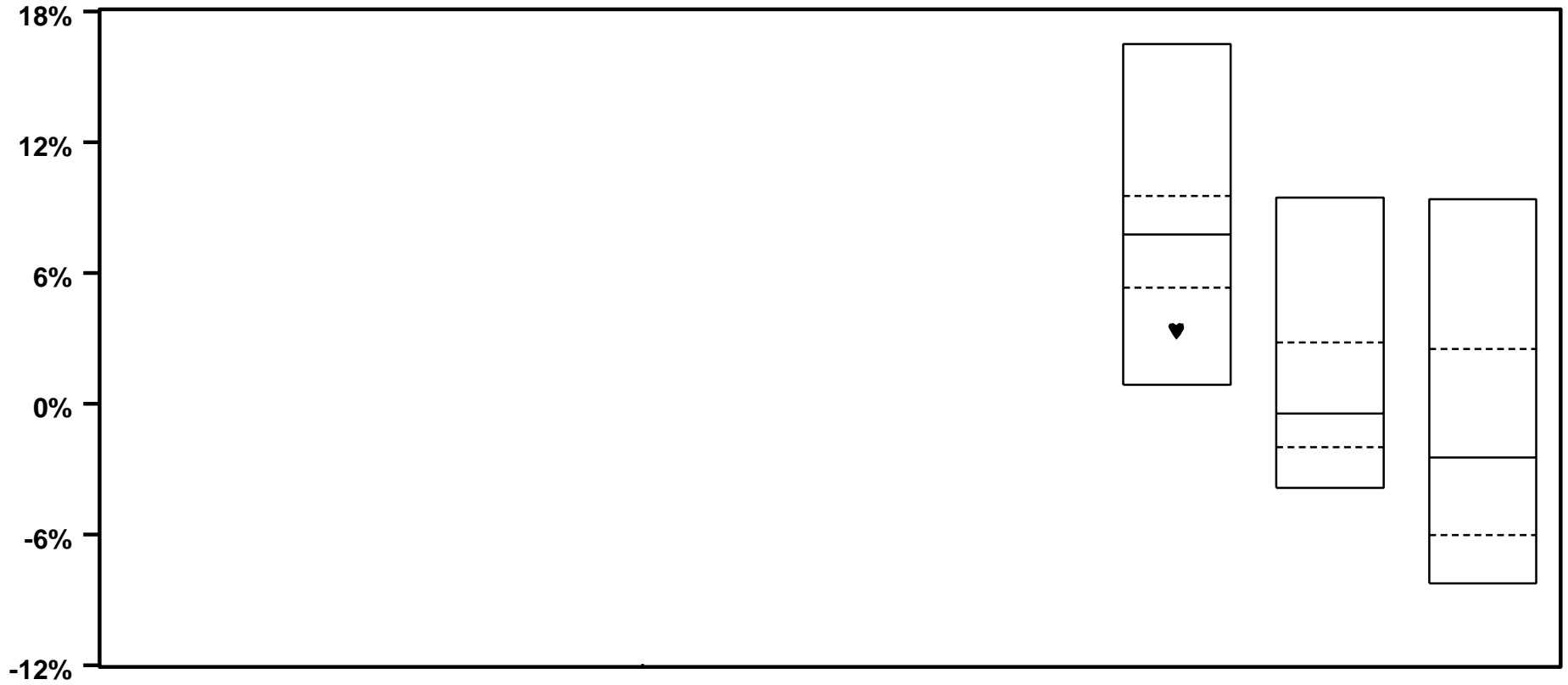

	LARGE VALUE	LARGE CORE	LARGE GROWTH
♥ UBS	3.4		
MEDIAN	7.8	-0.5	-2.5

VERMONT MUNICIPAL EMPLOYEES

INT'L DEVELOPED MKT EQUITY MANAGER STYLE ANALYSIS - TOTAL RETURNS

YEAR ENDING 3/04

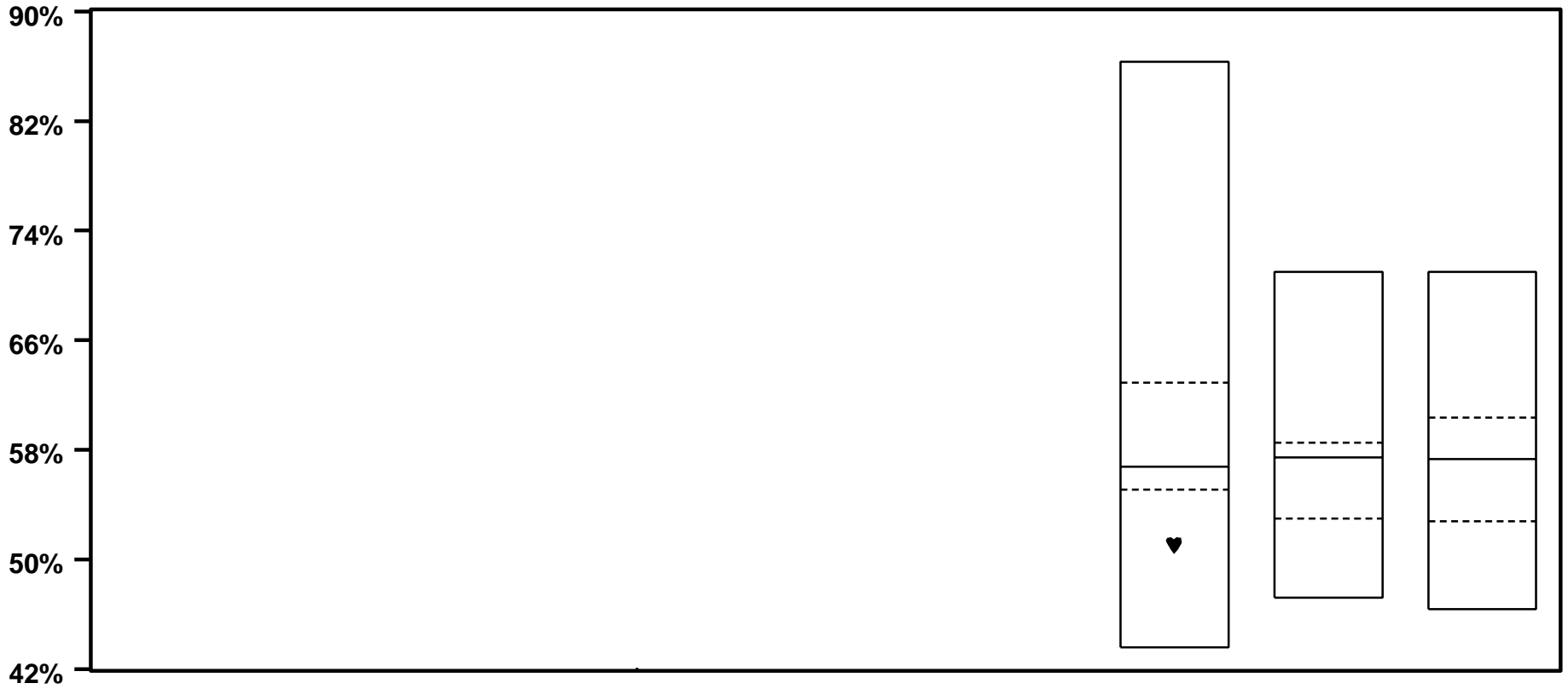

	LARGE VALUE	LARGE CORE	LARGE GROWTH
♥ UBS	51.1		
	84		
MEDIAN	56.8	57.5	57.3

VERMONT MUNICIPAL EMPLOYEES

INT'L DEVELOPED MKT EQUITY MANAGER STYLE ANALYSIS - TOTAL RETURNS

YEAR ENDING 3/03



	LARGE VALUE	LARGE CORE	LARGE GROWTH
♥ UBS	- 20.4		
	53		
MEDIAN	- 19.8	- 22.7	- 24.7

VERMONT MUNICIPAL EMPLOYEES

INT'L DEVELOPED MKT EQUITY MANAGER STYLE ANALYSIS - TOTAL RETURNS

YEAR ENDING 3/02



	LARGE VALUE	LARGE CORE	LARGE GROWTH
♥ UBS	1.0		
MEDIAN	0.9	-2.6	-6.3

VERMONT MUNICIPAL EMPLOYEES

INT'L DEVELOPED MKT EQUITY MANAGER STYLE ANALYSIS - TOTAL RETURNS

YEAR ENDING 3/01

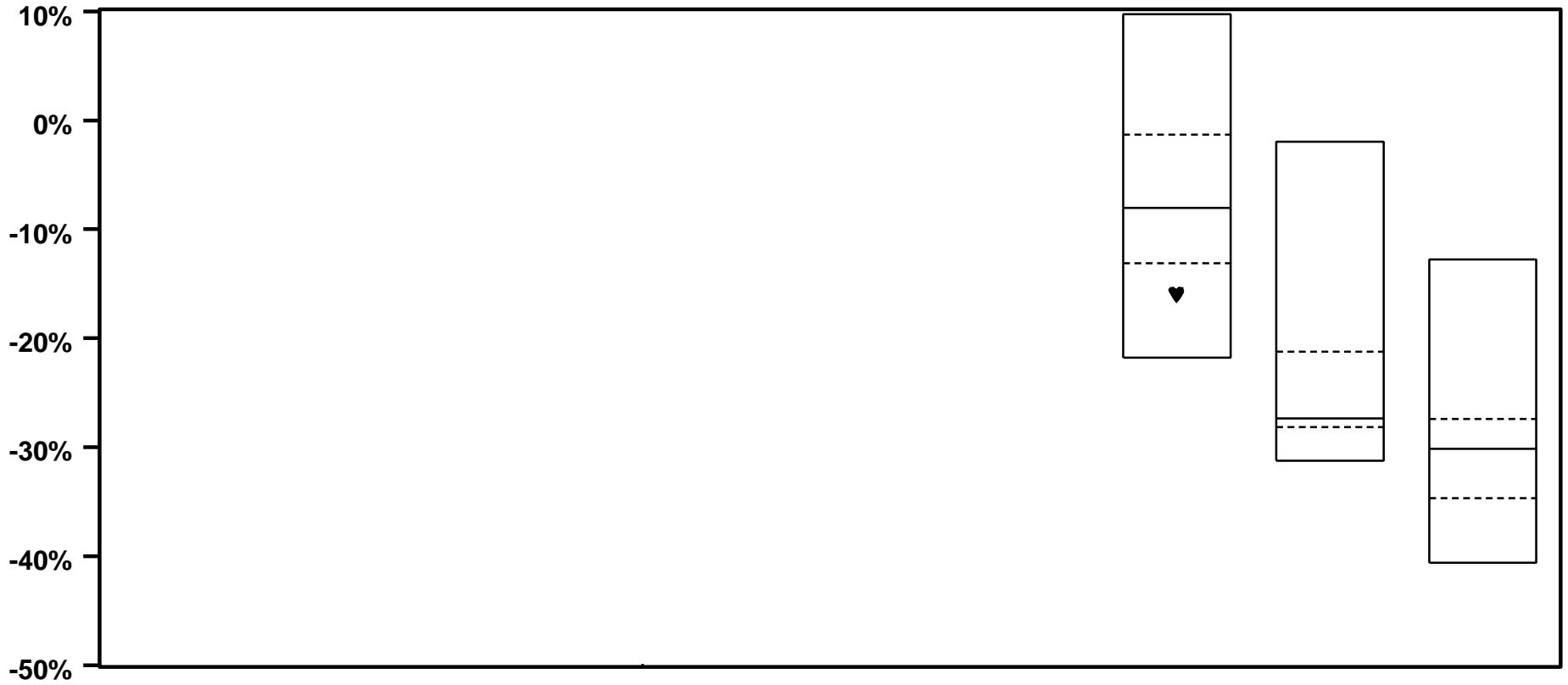

	LARGE VALUE	LARGE CORE	LARGE GROWTH
♥ UBS	- 16.0	84	
MEDIAN	- 8.0	- 27.4	- 30.1

VERMONT MUNICIPAL EMPLOYEES

INT'L DEVELOPED MKT EQUITY MANAGER STYLE ANALYSIS - TOTAL RETURNS

YEAR ENDING 3/00

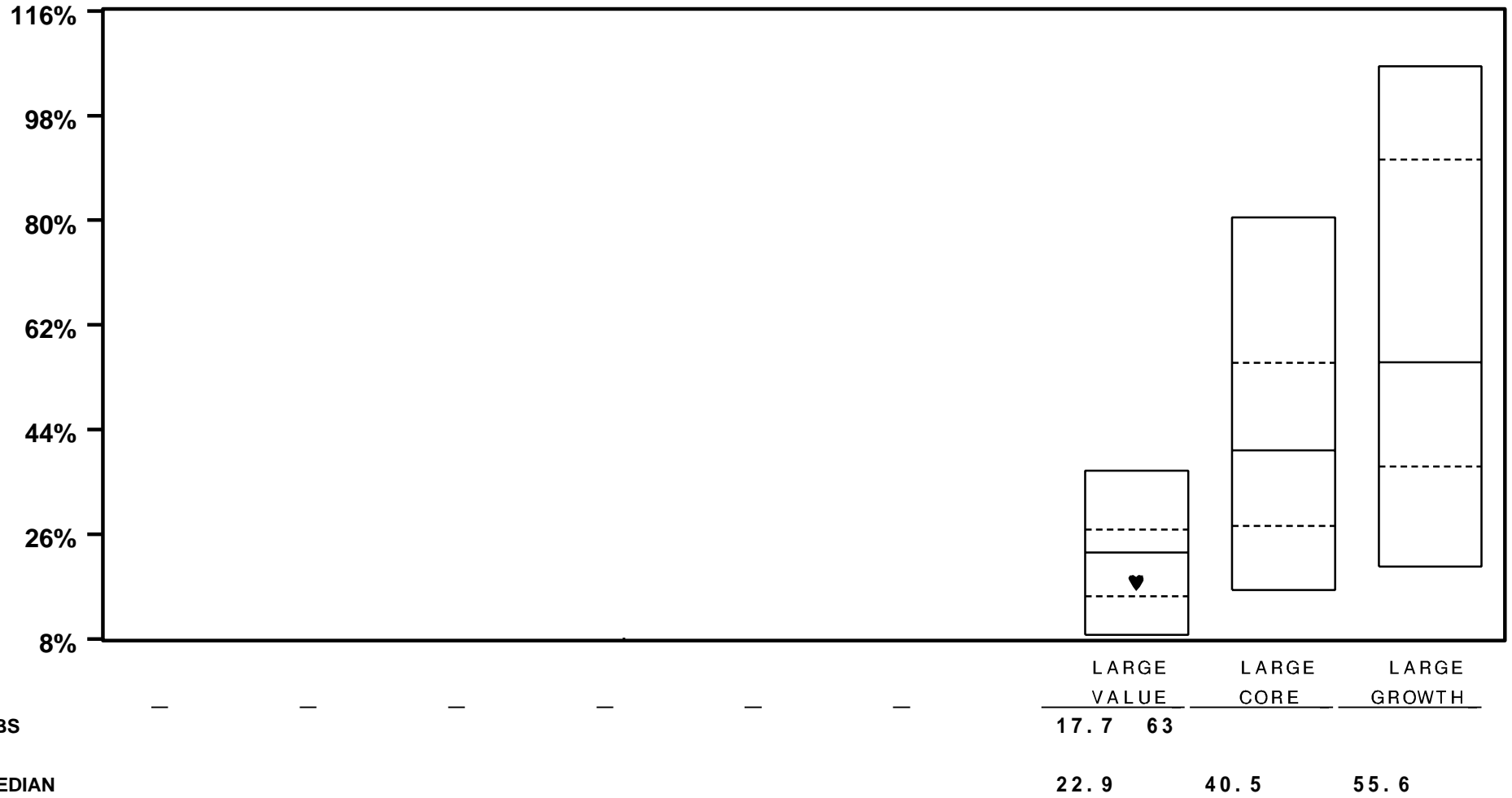

VERMONT MUNICIPAL EMPLOYEES

BOND SUMMARY STATISTICS

QUARTER ENDING 3/05

MUNICIPAL SYSTEM COMPOSITE

	PORTFOLIO	LB AGGREGATE
TOTAL NUMBER OF SECURITIES	498	
TOTAL MARKET VALUE	\$ 74,888,127	
CURRENT COUPON	5.06	5.22
YIELD TO MATURITY	4.71	4.86
AVERAGE MATURITY	5.24	7.12
DURATION	3.69	4.50
QUALITY	9.25	8.50

YIELD TO MATURITY	% HELD
0.0 - 5.0	49.6
5.0 - 7.0	28.9
7.0 - 9.0	3.6
9.0 - 11.0	0.1
11.0 - 13.0	0.0
13.0+	0.0
UNCLASSIFIED	17.8

AVERAGE MATURITY	% HELD
0.0 - 1.0	7.4
1.0 - 3.0	30.7
3.0 - 5.0	19.9
5.0 - 10.0	18.8
10.0 - 20.0	0.2
20.0+	5.3
UNCLASSIFIED	17.8

DURATION YEARS	% HELD
0.0 - 1.0	9.8
1.0 - 3.0	28.2
3.0 - 4.0	19.7
4.0 - 6.0	12.1
6.0 - 8.0	6.7
8.0+	5.3
UNCLASSIFIED	17.8

QUALITY	% HELD
GOVT (10)	72.1
Aaa (10)	6.0
Aa (9)	1.8
A (8)	2.2
Baa (7)	5.5
Below Baa (6 - 1)	11.2
Other	1.1

COUPON	% HELD
0.0 - 5.0	53.1
5.0 - 7.0	30.6
7.0 - 9.0	10.5
9.0 - 11.0	5.6
11.0 - 13.0	0.2
13.0+	0.0
UNCLASSIFIED	0.0

VERMONT MUNICIPAL EMPLOYEES

BOND SUMMARY STATISTICS

QUARTER ENDING 3/05

SEIX CORE

	PORTFOLIO	LB AGGREGATE
TOTAL NUMBER OF SECURITIES	205	
TOTAL MARKET VALUE	\$ 66,096,202	
CURRENT COUPON	4.62	5.22
YIELD TO MATURITY	4.41	4.86
AVERAGE MATURITY	5.18	7.12
DURATION	3.64	4.50
QUALITY	9.75	8.50

YIELD TO MATURITY	% HELD
0.0 - 5.0	55.5
5.0 - 7.0	23.8
7.0 - 9.0	0.6
9.0 - 11.0	0.0
11.0 - 13.0	0.0
13.0+	0.0
UNCLASSIFIED	20.2

AVERAGE MATURITY	% HELD
0.0 - 1.0	7.6
1.0 - 3.0	31.3
3.0 - 5.0	19.8
5.0 - 10.0	15.6
10.0 - 20.0	0.0
20.0+	5.6
UNCLASSIFIED	20.2

DURATION YEARS	% HELD
0.0 - 1.0	10.5
1.0 - 3.0	28.5
3.0 - 4.0	20.0
4.0 - 6.0	8.1
6.0 - 8.0	6.7
8.0+	5.6
UNCLASSIFIED	20.2

QUALITY	% HELD
GOVT (10)	81.7
Aaa (10)	6.8
Aa (9)	2.1
A (8)	2.5
Baa (7)	5.5
Below Baa (6 - 1)	0.3
Other	1.0

COUPON	% HELD
0.0 - 5.0	60.1
5.0 - 7.0	32.3
7.0 - 9.0	4.8
9.0 - 11.0	2.9
11.0 - 13.0	0.0
13.0+	0.0
UNCLASSIFIED	0.0

VERMONT MUNICIPAL EMPLOYEES

BOND SUMMARY STATISTICS

QUARTER ENDING 3/05

SEIX HIGH YIELD

	PORTFOLIO	CITI BB&B ALL
TOTAL NUMBER OF SECURITIES	293	
TOTAL MARKET VALUE	8,791,924	
CURRENT COUPON	8.36	
YIELD TO MATURITY	6.49	
AVERAGE MATURITY	5.59	
DURATION	4.00	
QUALITY	5.50	

YIELD TO MATURITY	% HELD
0.0 - 5.0	5.4
5.0 - 7.0	67.4
7.0 - 9.0	26.0
9.0 - 11.0	1.1
11.0 - 13.0	0.0
13.0+	0.0
UNCLASSIFIED	0.0

AVERAGE MATURITY	% HELD
0.0 - 1.0	5.5
1.0 - 3.0	26.0
3.0 - 5.0	21.1
5.0 - 10.0	42.8
10.0 - 20.0	1.7
20.0+	2.8
UNCLASSIFIED	0.0

DURATION YEARS	% HELD
0.0 - 1.0	4.5
1.0 - 3.0	26.2
3.0 - 4.0	17.9
4.0 - 6.0	41.8
6.0 - 8.0	6.7
8.0+	2.8
UNCLASSIFIED	0.0

QUALITY	% HELD
GOVT (10)	0.0
Aaa (10)	0.0
Aa (9)	0.0
A (8)	0.0
Baa (7)	5.2
Below Baa (6 - 1)	93.4
Other	1.4

COUPON	% HELD
0.0 - 5.0	0.3
5.0 - 7.0	18.3
7.0 - 9.0	53.2
9.0 - 11.0	26.2
11.0 - 13.0	2.0
13.0+	0.0
UNCLASSIFIED	0.0

VERMONT MUNICIPAL EMPLOYEES

BOND PORTFOLIO CHARACTERISTICS

PERIODS ENDING 3/05

AVERAGE MATURITY (YRS)

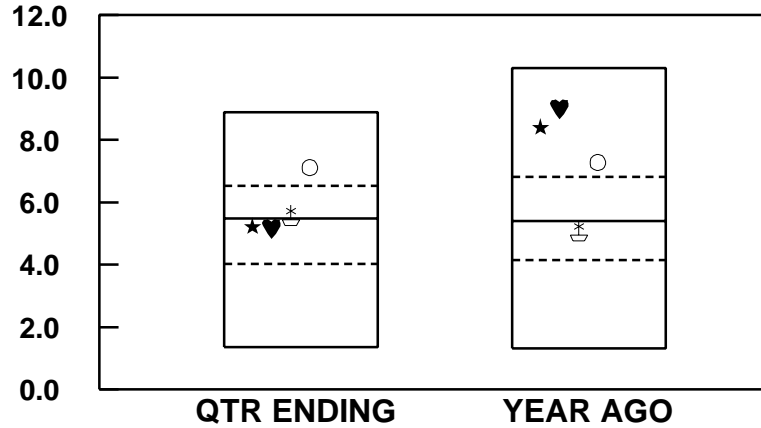

DURATION (YRS)

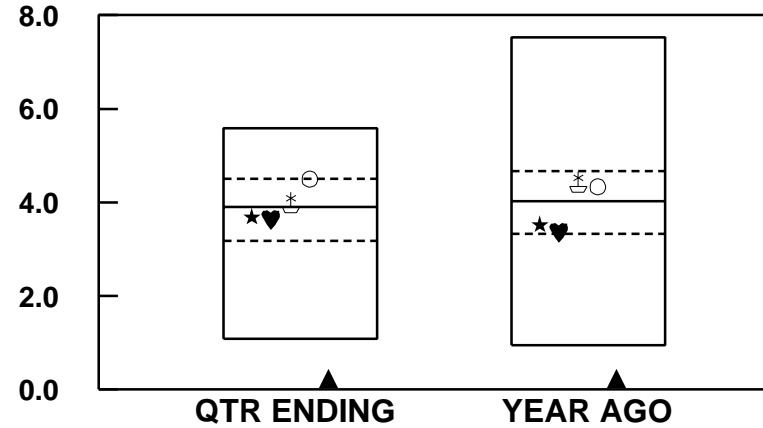

EFFECTS ON RETURN

- H
- MH
- ML
- L

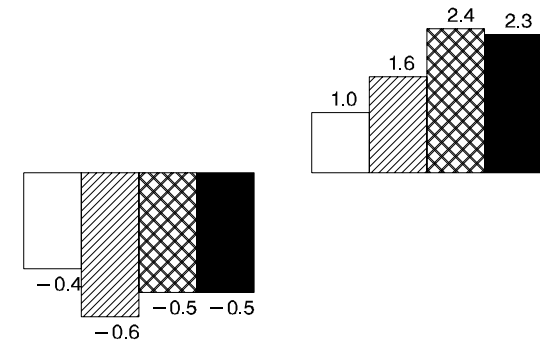
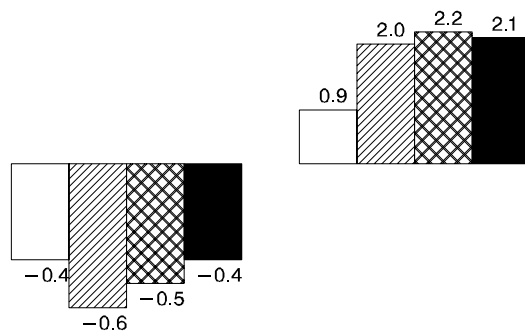

	QTR ENDING		YEAR AGO		QTR ENDING		YEAR AGO	
★ MUNI COMPOSITE	5.24	54	8.41	10	3.69	54	3.53	69
♥ SEIX CORE	5.18	54	9.00	7	3.64	55	3.37	73
⌘ SEIX HIGH YIELD	5.59	48	5.09	61	4.00	47	4.43	31
○ LB AGGREGATE	7.12	14	7.29	19	4.50	25	4.33	37
▲ 90 DAY T-BILLS					0.25	98	0.25	97
MEDIAN	5.49		5.40		3.90		4.02	

VERMONT MUNICIPAL EMPLOYEES

BOND PORTFOLIO CHARACTERISTICS

PERIODS ENDING 3/05

COUPON

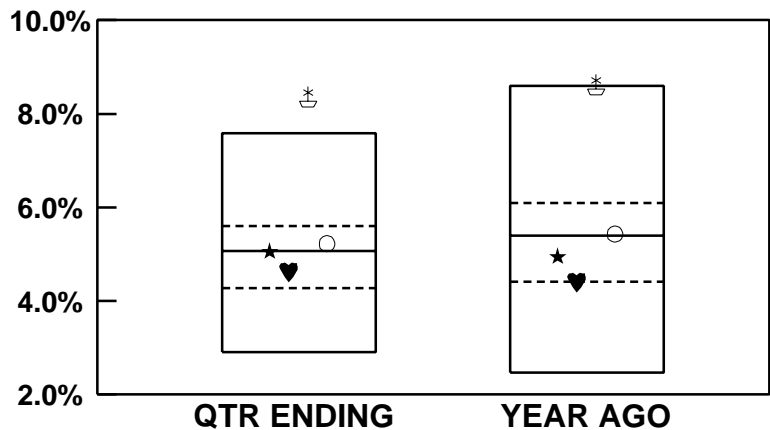

QUALITY

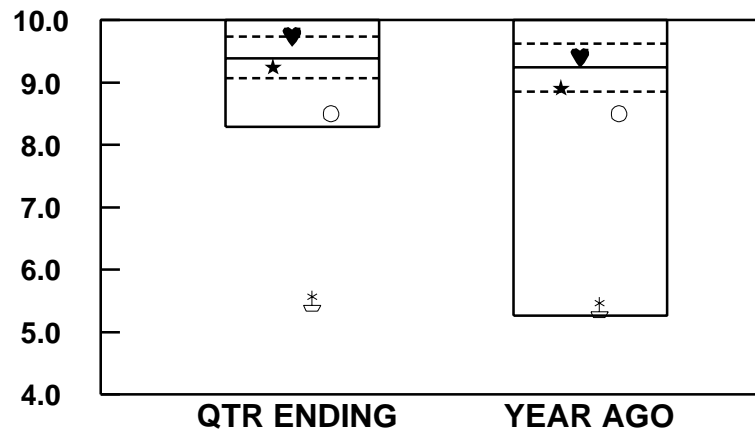

EFFECTS ON RETURN

- H
- MH
- ML
- L

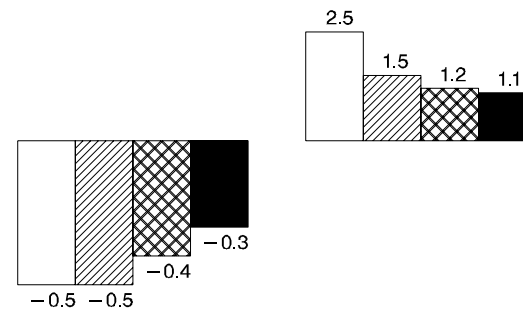
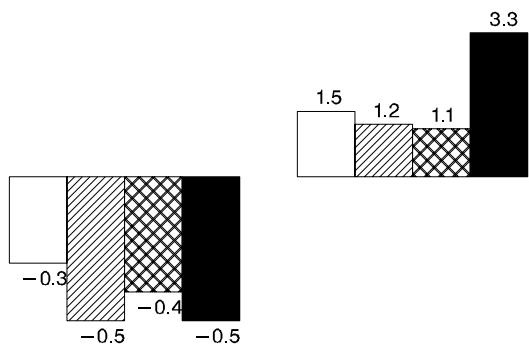

	QTR ENDING	YEAR AGO	QTR ENDING	YEAR AGO
★ MUNI COMPOSITE	5.06	4.95	9.25	8.91
♥ SEIX CORE	4.62	4.41	9.75	9.41
⊕ SEIX HIGH YIELD	8.36	8.63	5.50	5.40
○ LB AGGREGATE	5.22	5.43	8.50	8.50
MEDIAN	5.06	5.40	9.39	9.24

VERMONT MUNICIPAL EMPLOYEES

FIXED INCOME SECTOR ALLOCATION

AS OF MARCH 31, 2005

MUNICIPAL SYSTEM COMPOSITE

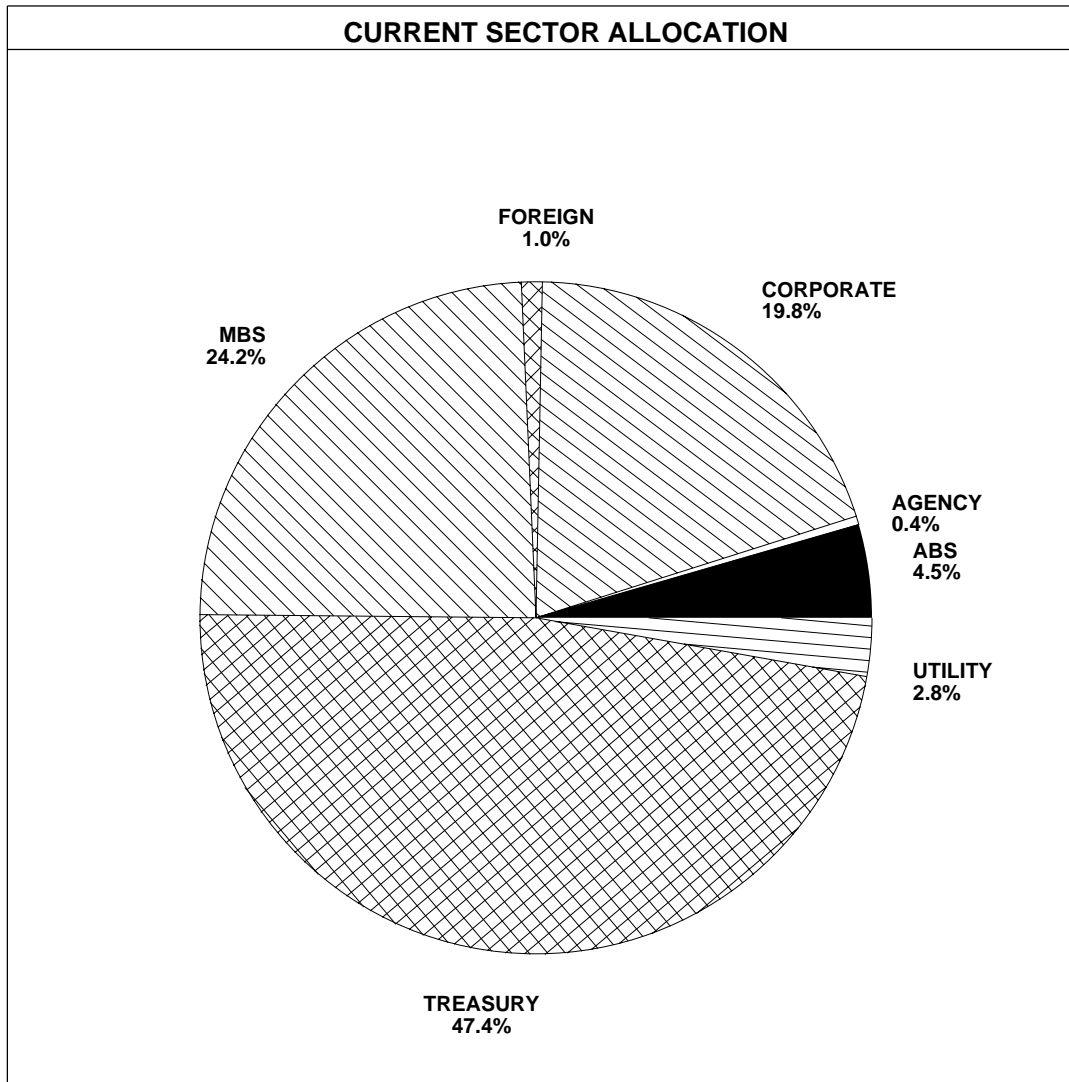

<u>SECTOR</u>	<u>ACCOUNT WEIGHT</u>	<u>INDEX WEIGHT</u>	<u>DIFFERENCE</u>
TREASURIES	47.4%	25.3%	22.0%
AGENCIES	0.4%	11.0%	-10.6%
CORPORATES	19.8%	18.4%	1.3%
UTILITIES	2.8%	1.7%	1.1%
FOREIGN	1.0%	4.0%	-3.0%
MBS	24.2%	35.0%	-10.8%
CMO	0.0%	0.0%	0.0%
ABS	4.5%	4.5%	-0.1%
MUNICIPALS	0.0%	0.0%	0.0%
OTHERS	0.0%	0.0%	0.0%
TOTAL	100.0%	100.0%	0.0%

Benchmark: LB AGGREGATE

VERMONT MUNICIPAL EMPLOYEES
FIXED INCOME SECTOR ALLOCATION
AS OF MARCH 31, 2005

SEIX CORE

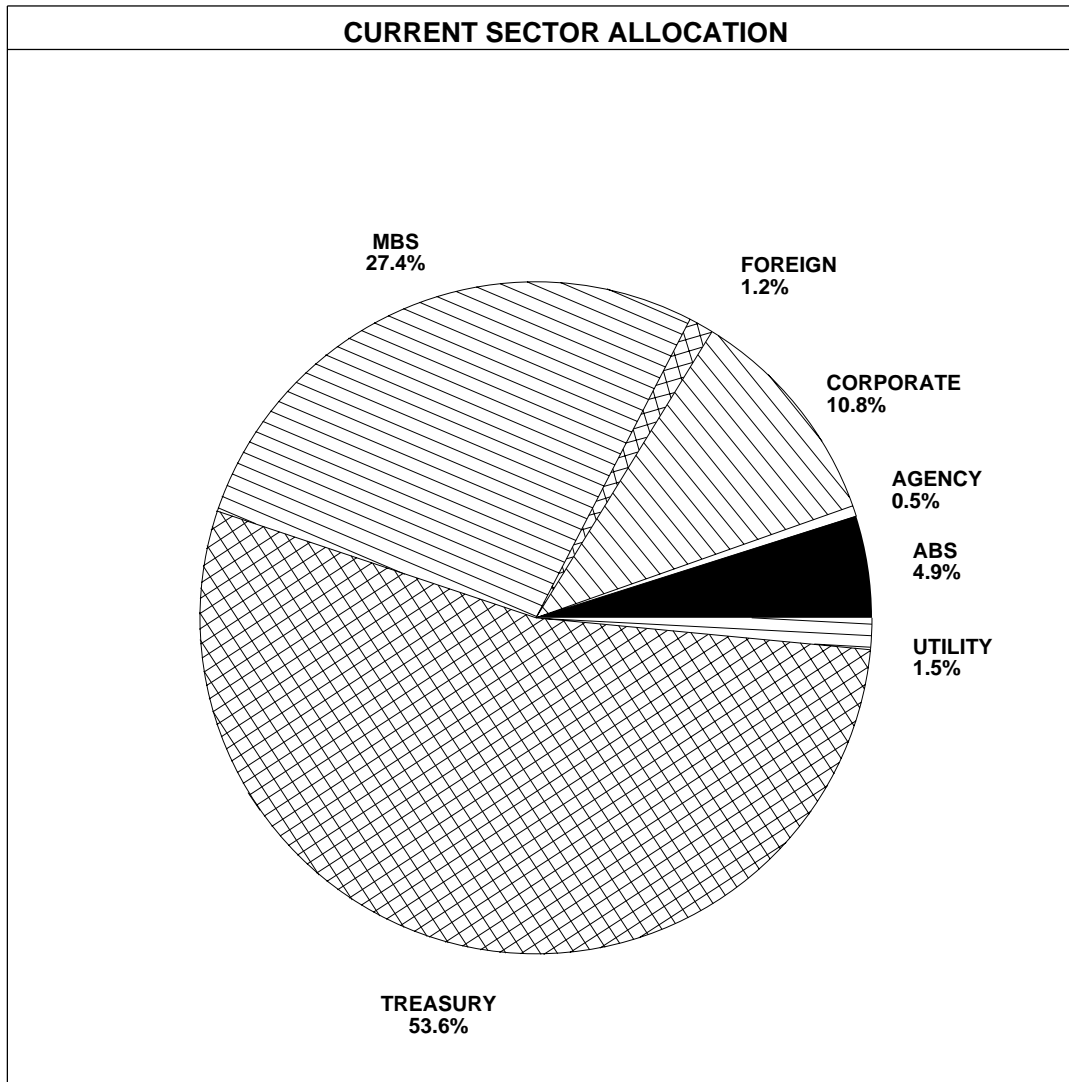

<u>SECTOR</u>	<u>ACCOUNT WEIGHT</u>	<u>INDEX WEIGHT</u>	<u>DIFFERENCE</u>
TREASURIES	53.6%	25.3%	28.3%
AGENCIES	0.5%	11.0%	-10.5%
CORPORATES	10.8%	18.4%	-7.6%
UTILITIES	1.5%	1.7%	-0.1%
FOREIGN	1.2%	4.0%	-2.8%
MBS	27.4%	35.0%	-7.6%
CMO	0.0%	0.0%	0.0%
ABS	4.9%	4.5%	0.4%
MUNICIPALS	0.0%	0.0%	0.0%
OTHERS	0.0%	0.0%	0.0%
TOTAL	100.0%	100.0%	0.0%

Benchmark: LB AGGREGATE

**VERMONT MUNICIPAL EMPLOYEES
FIXED INCOME SECTOR ALLOCATION
AS OF MARCH 31, 2005**

SEIX HIGH YIELD

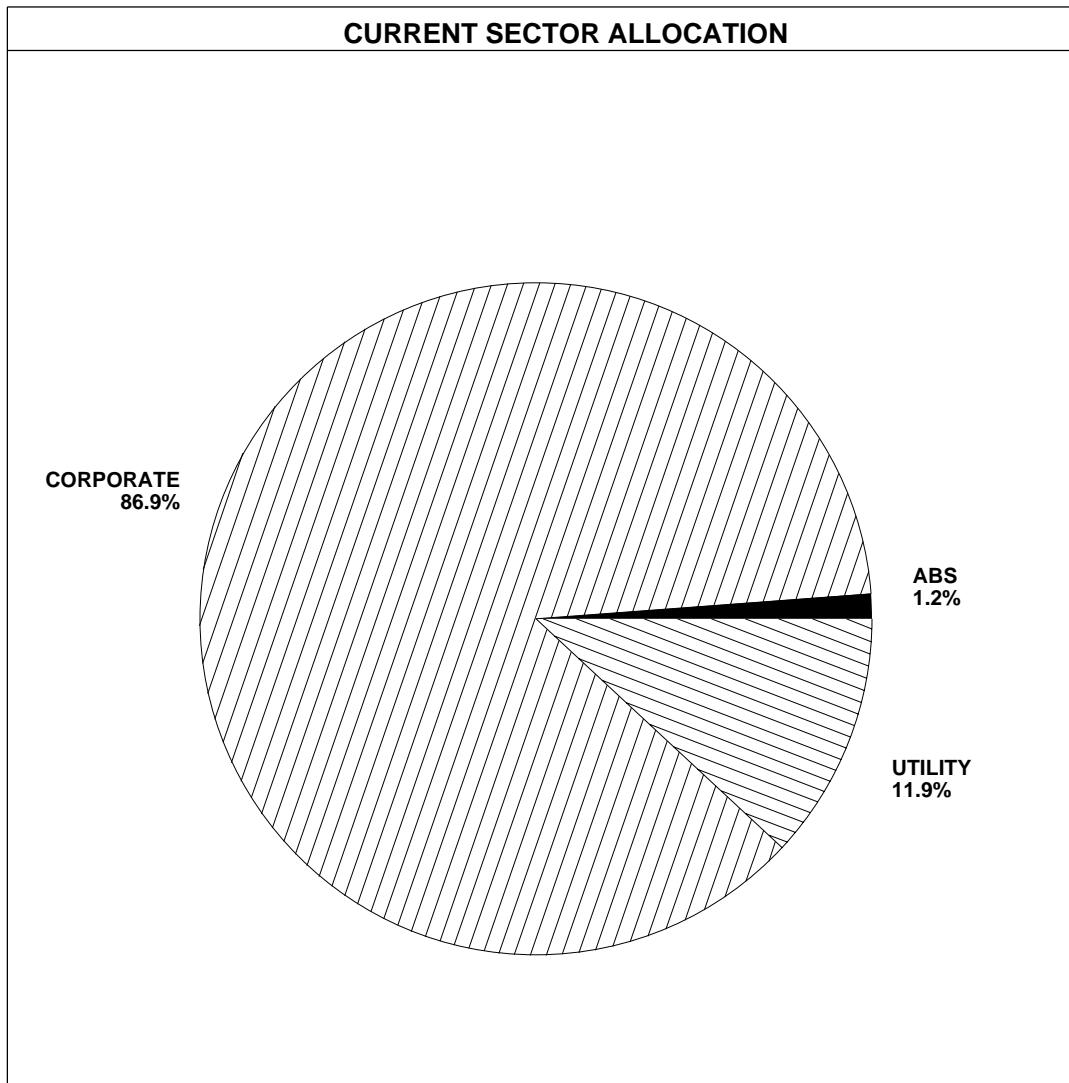

<u>SECTOR</u>	<u>ACCOUNT WEIGHT</u>	<u>INDEX WEIGHT</u>	<u>DIFFERENCE</u>
TREASURIES	0.0%	N/ A	N/ A
AGENCIES	0.0%	N/ A	N/ A
CORPORATES	86.9%	N/ A	N/ A
UTILITIES	11.9%	N/ A	N/ A
FOREIGN	0.0%	N/ A	N/ A
MBS	0.0%	N/ A	N/ A
CMO	0.0%	N/ A	N/ A
ABS	1.2%	N/ A	N/ A
MUNICIPALS	0.0%	N/ A	N/ A
OTHERS	0.0%	N/ A	N/ A
TOTAL	100.0%	N/ A	N/ A

Benchmark: CITI BB&B ALL

VERMONT MUNICIPAL EMPLOYEES
FIXED INCOME ATTRIBUTION - BOND FUNDS
QUARTER ENDING 3/05

<u>MANAGER</u>	<u>RETURN</u>	<u>BEGINNING DURATION</u>	<u>ENDING DURATION</u>	<u>AVERAGE DURATION</u>	<u>RETURN DUE TO MARKET</u>	<u>INTEREST RATE ANTICIPATION</u>	<u>SECURITY SELECTION</u>
SEIX CORE	- 0.25	4.11	3.64	3.87	- 0.32	0.06	0.01
SEIX HIGH YIELD	- 1.46	3.98	4.00	3.99	- 0.35	0.00	- 1.11
<u>BENCHMARKS</u>							
LB AGGREGATE	- 0.47	4.34	4.50	4.37			
90 DAY T-BILLS	0.57	0.25	0.25	0.25			
MARKET SENSITIVITY	- 0.25						

Due to Market = T-Bill return + (relative market sensitivity x (average duration - T-Bill duration))

Rate Anticipation = relative market sensitivity x current duration - average duration

Selection Effect = (account return - T-Bill return) - (relative market sensitivity x (current duration - T-Bill duration))

Relative Market Sensitivity = (Benchmark return - T-Bill return) / (Benchmark current duration - T-Bill duration)

Duration = Duration Option Adjusted Incl Cash Equiv

VERMONT MUNICIPAL EMPLOYEES
FIXED INCOME ATTRIBUTION - BOND ONLY
QUARTER ENDING 3/05

<u>MANAGER</u>	<u>RETURN</u>	<u>BEGINNING DURATION</u>	<u>ENDING DURATION</u>	<u>AVERAGE DURATION</u>	<u>RETURN DUE TO MARKET</u>	<u>INTEREST RATE ANTICIPATION</u>	<u>SECURITY SELECTION</u>
MUNI COMPOSITE	- 0.41	4.09	3.69	3.89	- 0.32	0.05	- 0.14
SEIX CORE	- 0.25	4.11	3.64	3.87	- 0.32	0.06	0.01
SEIX HIGH YIELD	- 1.46	3.98	4.00	3.99	- 0.35	0.00	- 1.11
<u>BENCHMARKS</u>							
LB AGGREGATE	- 0.47	4.34	4.50	4.37			
90 DAY T-BILLS	0.57	0.25	0.25	0.25			
MARKET SENSITIVITY	- 0.25						

Due to Market = T-Bill return + (relative market sensitivity x (average duration - T-Bill duration))

Rate Anticipation = relative market sensitivity x current duration - average duration

Selection Effect = (account return - T-Bill return) - (relative market sensitivity x (current duration - T-Bill duration))

Relative Market Sensitivity = (Benchmark return - T-Bill return) / (Benchmark current duration - T-Bill duration)

Duration = Duration Option Adjusted

VERMONT MUNICIPAL EMPLOYEES

BOND ONLY - RATES OF RETURN

COMPARED TO FUNDS WITH SIMILAR MATURITY

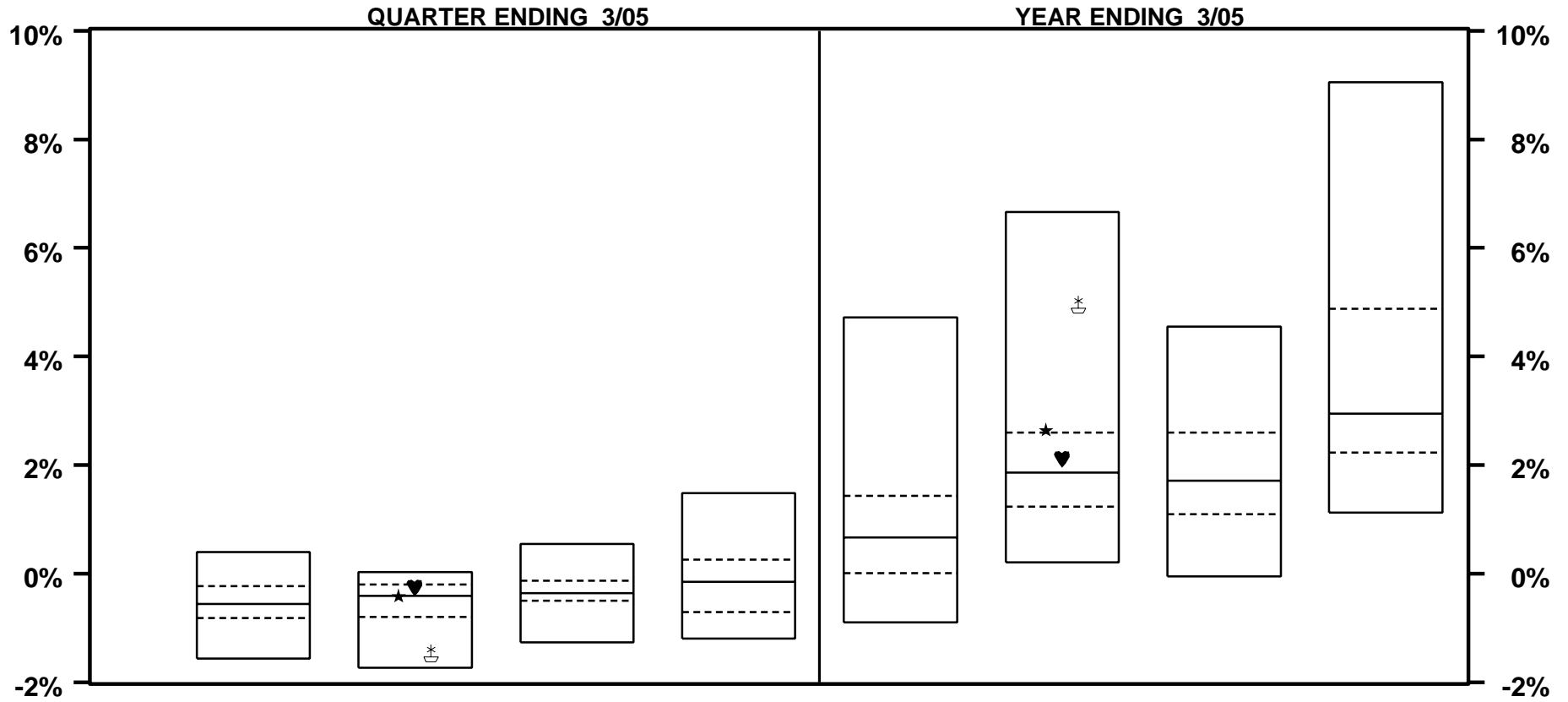

	BELOW 5 YEARS	5-7 YEARS	7-9 YEARS	ABOVE 9 YEARS	BELOW 5 YEARS	5-7 YEARS	7-9 YEARS	ABOVE 9 YEARS
★ MUNI COMPOSITE		- 0.4 51				2.6 24		
♥ SEIX CORE		- 0.3 31				2.1 41		
⌘ SEIX HIGH YIELD		- 1.5 89				5.0 11		
MEDIAN	- 0.6	- 0.4	- 0.4	- 0.1	0.7	1.9	1.7	3.0

VERMONT MUNICIPAL EMPLOYEES

BOND ONLY - RATES OF RETURN

COMPARED TO FUNDS WITH SIMILAR MATURITY

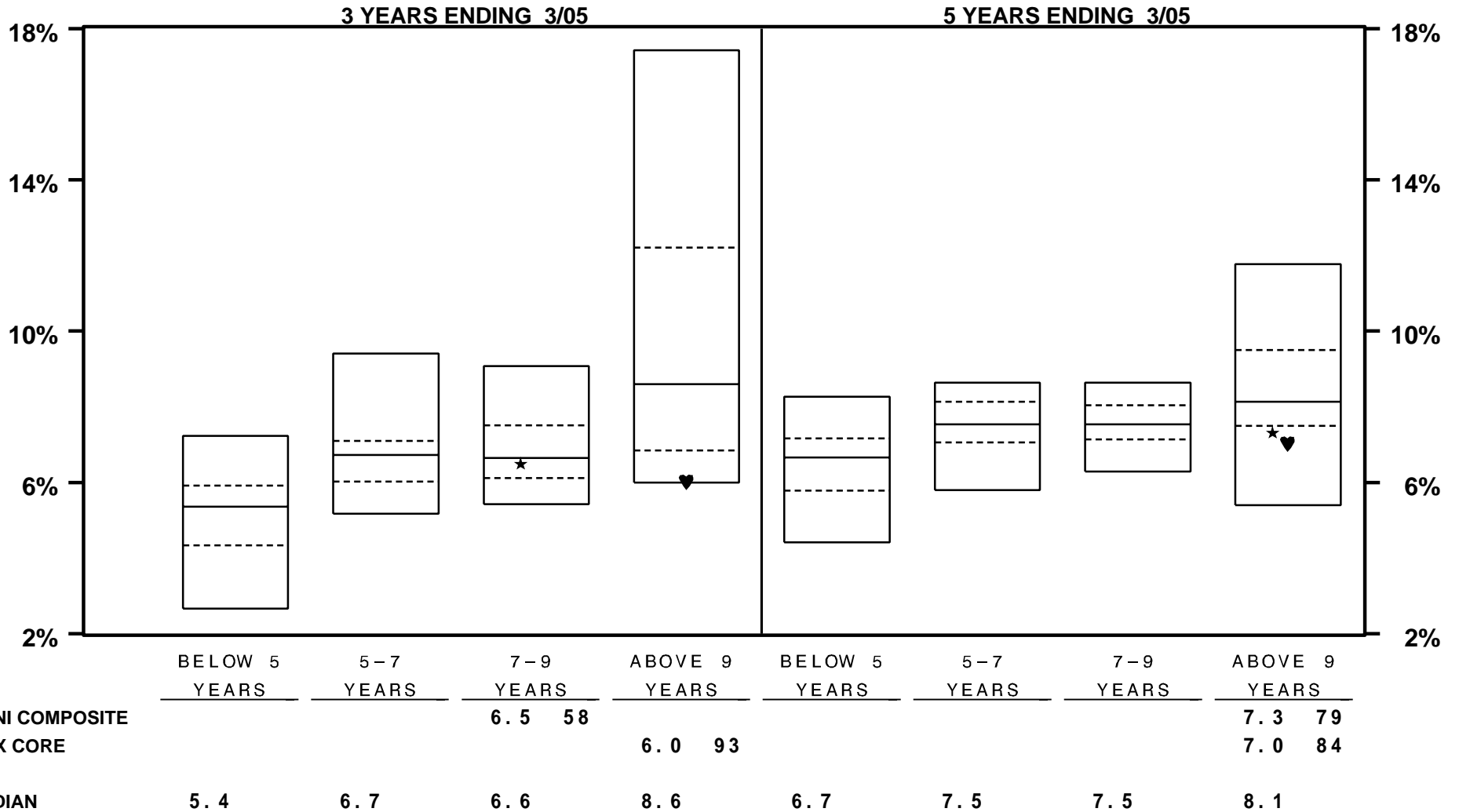

VERMONT MUNICIPAL EMPLOYEES

BOND ONLY - RATES OF RETURN

COMPARED TO FUNDS WITH SIMILAR DURATION

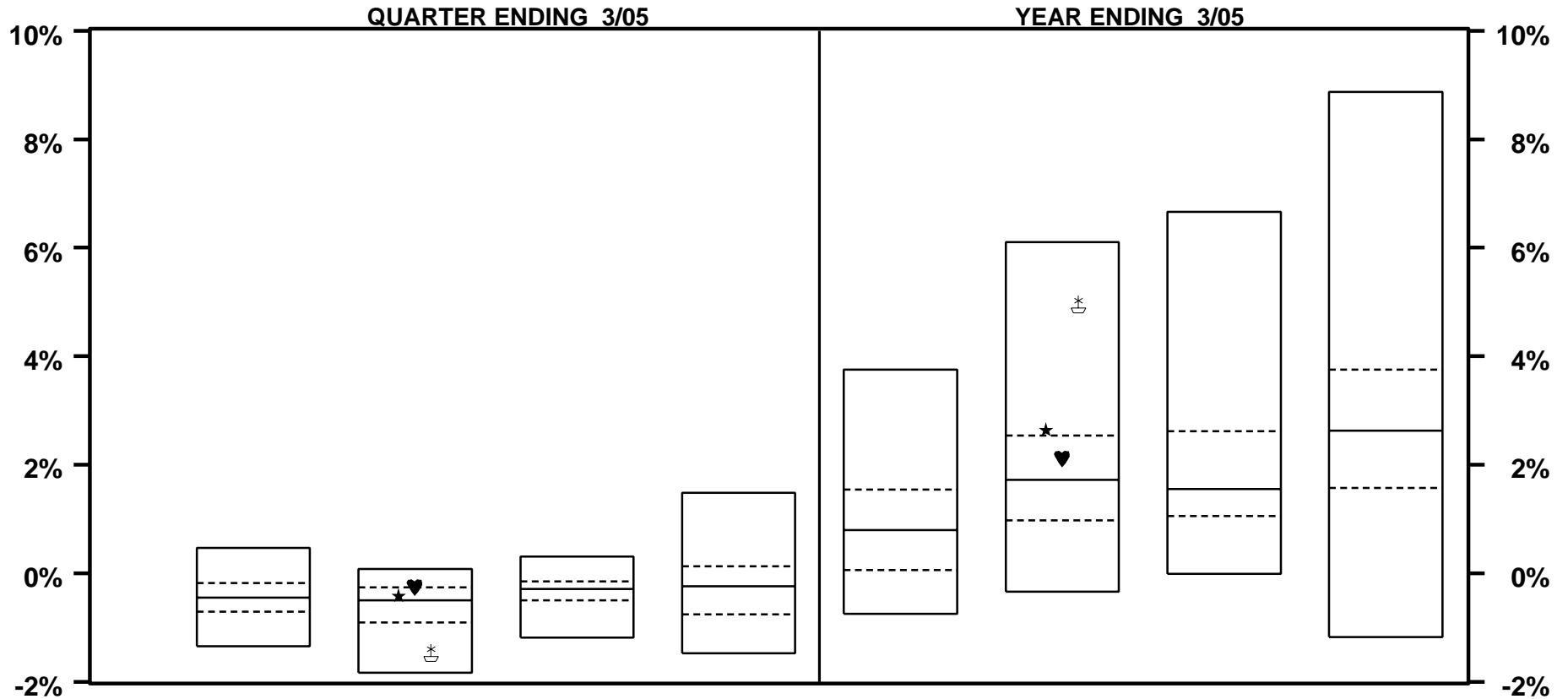

	BELOW 3.5 YEARS	3.5-4.5 YEARS	4.5-5.5 YEARS	ABOVE 5.5 YEARS	BELOW 3.5 YEARS	3.5-4.5 YEARS	4.5-5.5 YEARS	ABOVE 5.5 YEARS
★ MUNI COMPOSITE		- 0.4 40				2.6 22		
♥ SEIX CORE		- 0.3 24				2.1 40		
⊠ SEIX HIGH YIELD		- 1.5 86				5.0 9		
MEDIAN	- 0.5	- 0.5	- 0.3	- 0.2	0.8	1.7	1.6	2.6

VERMONT MUNICIPAL EMPLOYEES

BOND ONLY - RATES OF RETURN

COMPARED TO FUNDS WITH SIMILAR DURATION

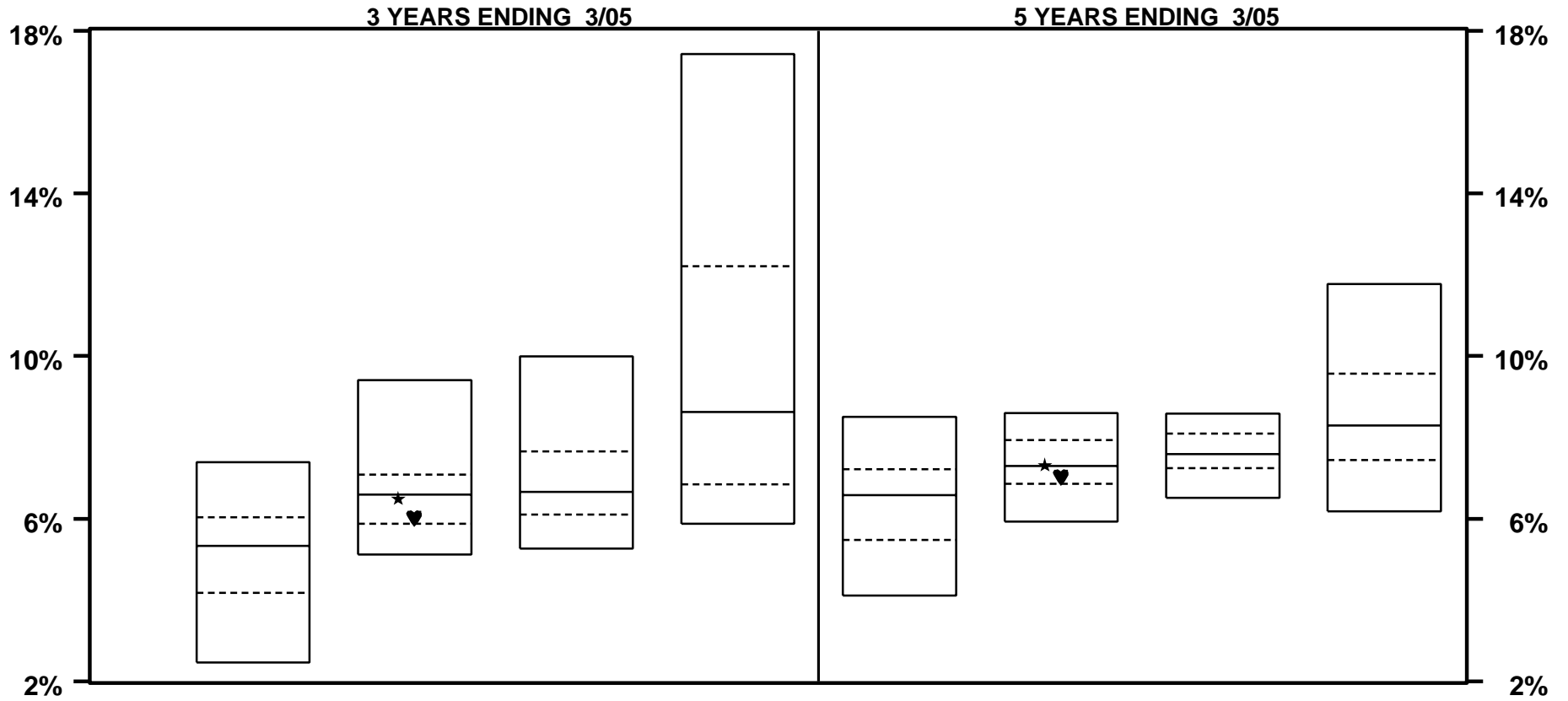

	3 YEARS ENDING 3/05				5 YEARS ENDING 3/05			
	BELOW 3.5 YEARS	3.5-4.5 YEARS	4.5-5.5 YEARS	ABOVE 5.5 YEARS	BELOW 3.5 YEARS	3.5-4.5 YEARS	4.5-5.5 YEARS	ABOVE 5.5 YEARS
★ MUNI COMPOSITE		6.5 52				7.3 49		
♥ SEIX CORE		6.0 69				7.0 66		
MEDIAN	5.3	6.6	6.7	8.6	6.6	7.3	7.6	8.3

VERMONT MUNICIPAL EMPLOYEES

BOND ONLY - RATES OF RETURN

COMPARED TO FUNDS WITH SIMILAR COUPON

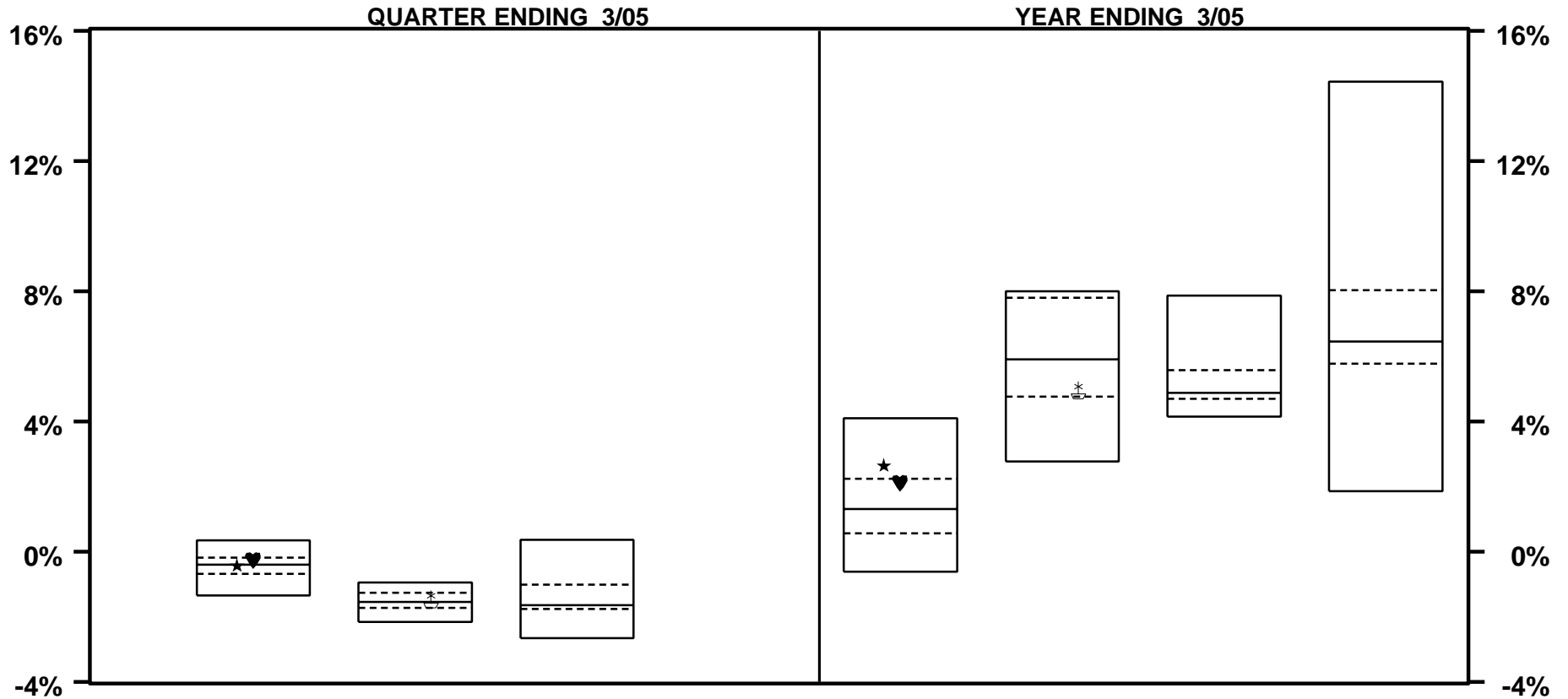

	QUARTER ENDING 3/05			YEAR ENDING 3/05			
	BELOW	8.0-8.5%	8.5-9.0%	BELOW	8.0-8.5%	8.5-9.0%	ABOVE
	8.0%		9.0%	8.0%			9.0%
★ MUNI COMPOSITE	- 0.4	51		2.6	13		
♥ SEIX CORE	- 0.3	34		2.1	27		
⊕ SEIX HIGH YIELD		- 1.5	36		5.0	69	
MEDIAN	- 0.4	- 1.5	- 1.6	1.3	5.9	4.9	6.5

VERMONT MUNICIPAL EMPLOYEES

BOND ONLY - RATES OF RETURN

COMPARED TO FUNDS WITH SIMILAR COUPON

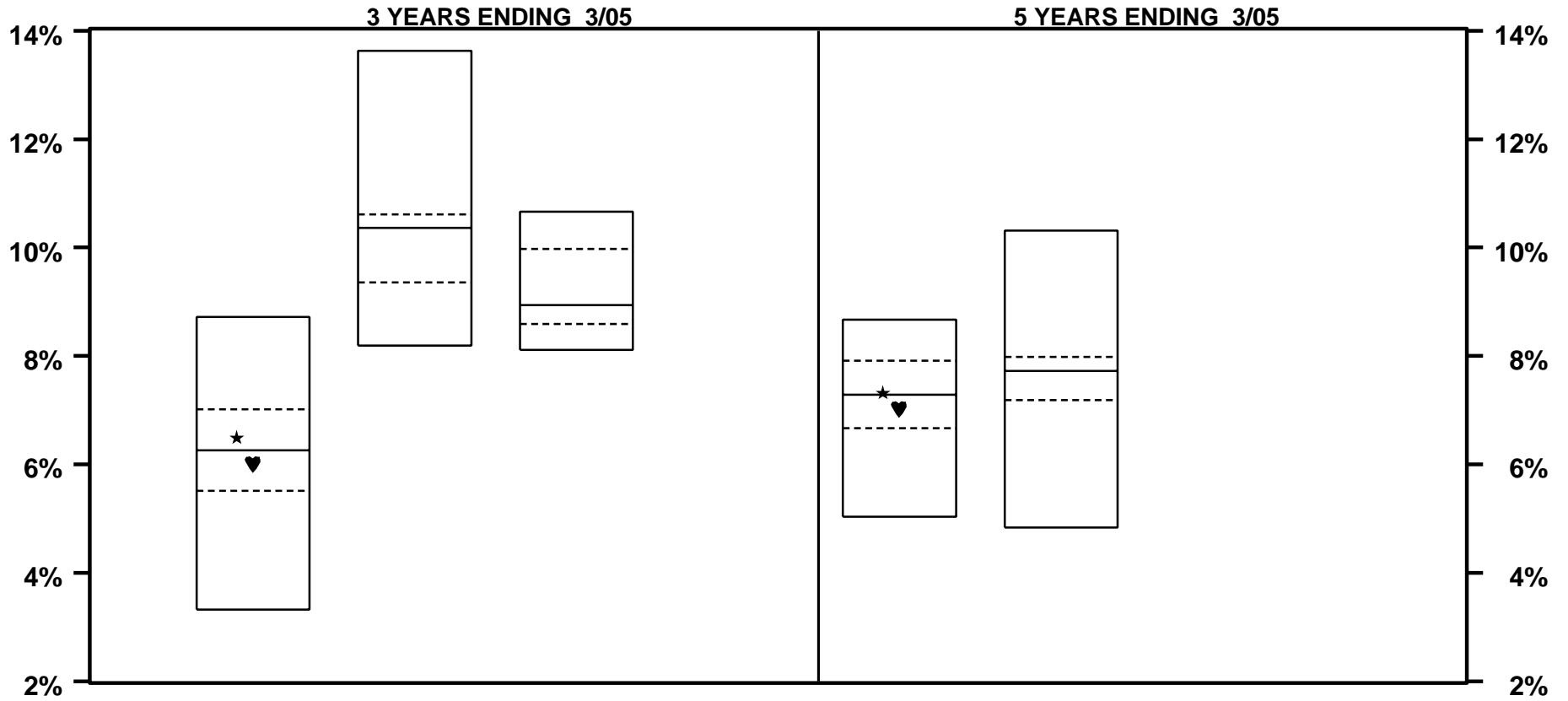

	3 YEARS ENDING 3/05			5 YEARS ENDING 3/05		
	BELOW 8.0%	8.0-8.5%	8.5-9.0%	BELOW 8.0%	8.0-8.5%	8.5-9.0%
★ MUNI COMPOSITE	6.5			7.3		
♥ SEIX CORE	6.0			7.0		
MEDIAN	6.3	10.4	8.9	7.3	7.7	

VERMONT MUNICIPAL EMPLOYEES

FIXED INCOME MANAGER STYLE DEFINITIONS

SHORT

Short Term Fixed Income managers are generally retained as "cash" managers. They provide an alternative to SHORT TERM INVESTMENT VEHICLES and attempt to add value through superior management of high quality short term instruments. In order to be classified as Short Term, a managers portfolio duration should be 0-40% of the Lehman Brothers Aggregate's and an average quality rating of at least 6.3. Contractual restrictions limiting a short term fund's duration generally preclude the use of one of the major bond indices as a relevant benchmark. Instead, 90 day T-Bills are generally used as the portfolio's standard.

INTERMEDIATE

An Intermediate manager invests in high quality issues with a duration that is 40-80% of the Lehman Brothers Aggregate and an average quality rating of at least 6.3. Although many Intermediate managers are contractually prevented from extending a portfolio's maturity, other Intermediate managers assert that intermediate duration securities provide the best risk/reward trade-off relative to short and long duration instruments.

CORE

A Core manager differs from the above three styles in that he does not concentrate on achieving a superior return within a certain duration range. Instead, he prefers to emphasize sector or individual bond selection to create a portfolio whose duration is similar to the index's, but produces a superior return. A Core manager's defining criteria include a duration ranging from 80-120% of the Lehman Brothers Aggregate and an average quality rating of at least 6.3.

CORE PLUS

Core-plus fixed income management is a strategy of incorporating moderate allocations to nonbenchmark sectors in order to achieve excess return without taking on excessive additional risk. Core-plus portfolios typically include diversifying exposure to sovereign, high yield, and/or emerging market debt. Core-plus is an assigned style.

LONG

To be classified as a Long manager, an investment manager's portfolio must have a duration that is greater than 120% of the Lehman Brothers Aggregate's and an average quality rating of at least 6.3. Long managers believe that the increased return provided by the long end of the maturity spectrum compensates for the higher volatility of longer duration issues.

HIGH YIELD

A High Yield Manager invests in lower quality, higher yielding issues; generally companies in financial difficulty or with limited financing means. The debt issued by these types of companies carry higher rates to compensate for the increased credit risk. A High Yield manager emphasizes security selection to take advantage of the superior return produced by the debt of less credit-worthy companies. A High Yield manager's portfolio must have a current yield to maturity that is at least 120% of the Lehman Brothers Aggregate's and an average quality rating less than or equal to 6.3.

VERMONT MUNICIPAL EMPLOYEES

FIXED INCOME MANAGER STYLE ANALYSIS - TOTAL RETURNS

QUARTER ENDING 3/05

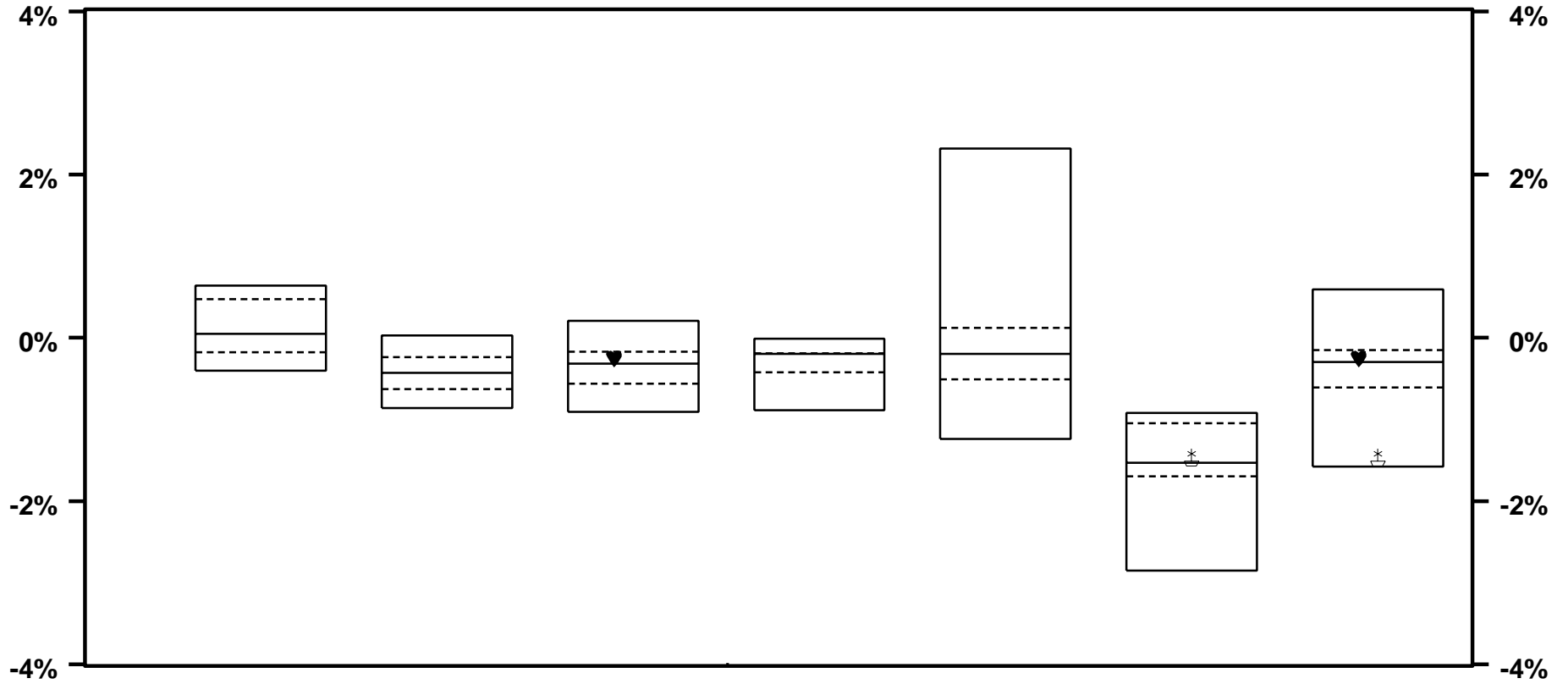

	SHORT	INTER-MEDIATE	CORE	CORE PLUS	LONG	HIGH YIELD	BOND UNIV
♥ SEIX CORE			- 0.3 40				- 0.3 44
☆ SEIX HIGH YIELD						- 1.5 40	- 1.5 93
MEDIAN	0.1	- 0.4	- 0.3	- 0.2	- 0.2	- 1.5	- 0.3

VERMONT MUNICIPAL EMPLOYEES

FIXED INCOME MANAGER STYLE ANALYSIS - TOTAL RETURNS

YEAR ENDING 3/05

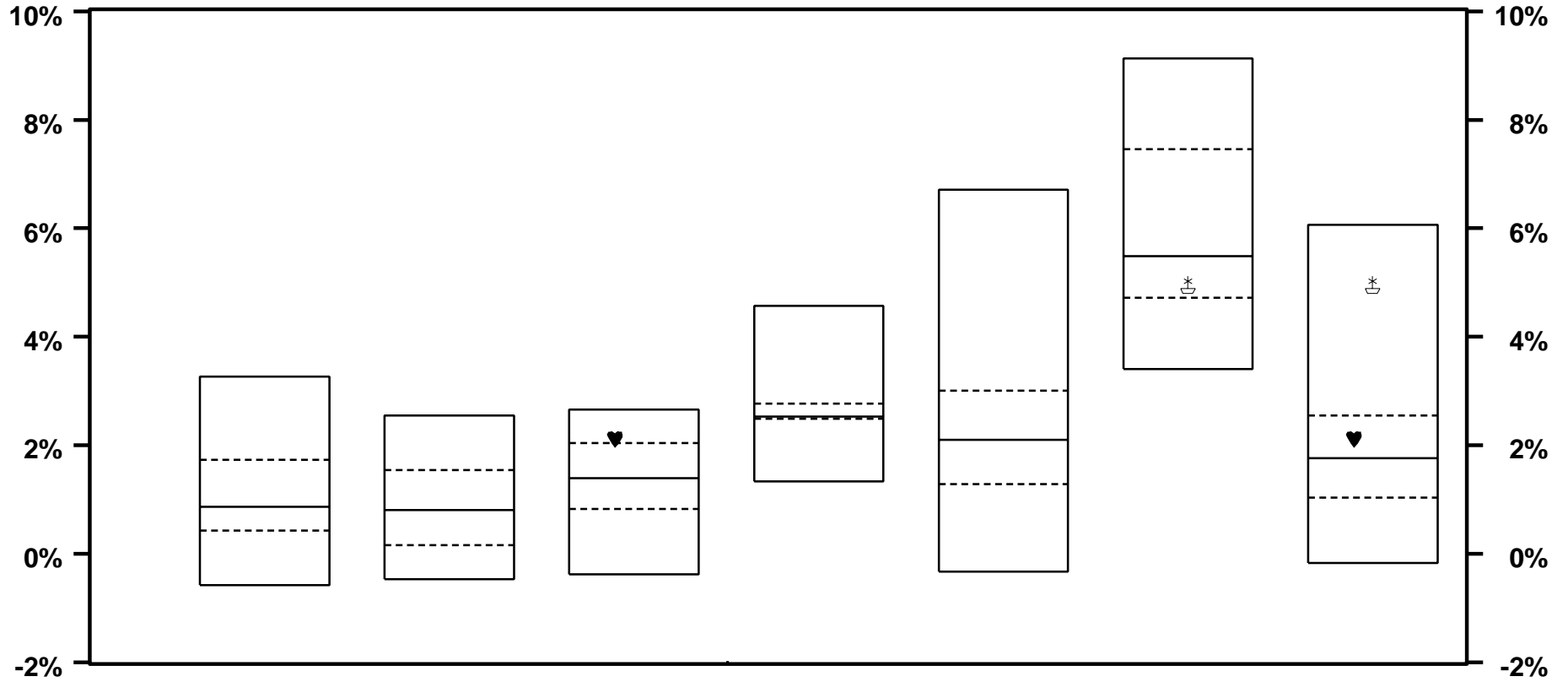

	SHORT	INTER-MEDIATE	CORE	CORE PLUS	LONG	HIGH YIELD	BOND UNIV
SEIX CORE			2.1				2.1
SEIX HIGH YIELD			22			5.0	62
MEDIAN	0.9	0.8	1.4	2.5	2.1	5.5	1.8

VERMONT MUNICIPAL EMPLOYEES

FIXED INCOME MANAGER STYLE ANALYSIS - TOTAL RETURNS

TWO YEARS ENDING 3/05

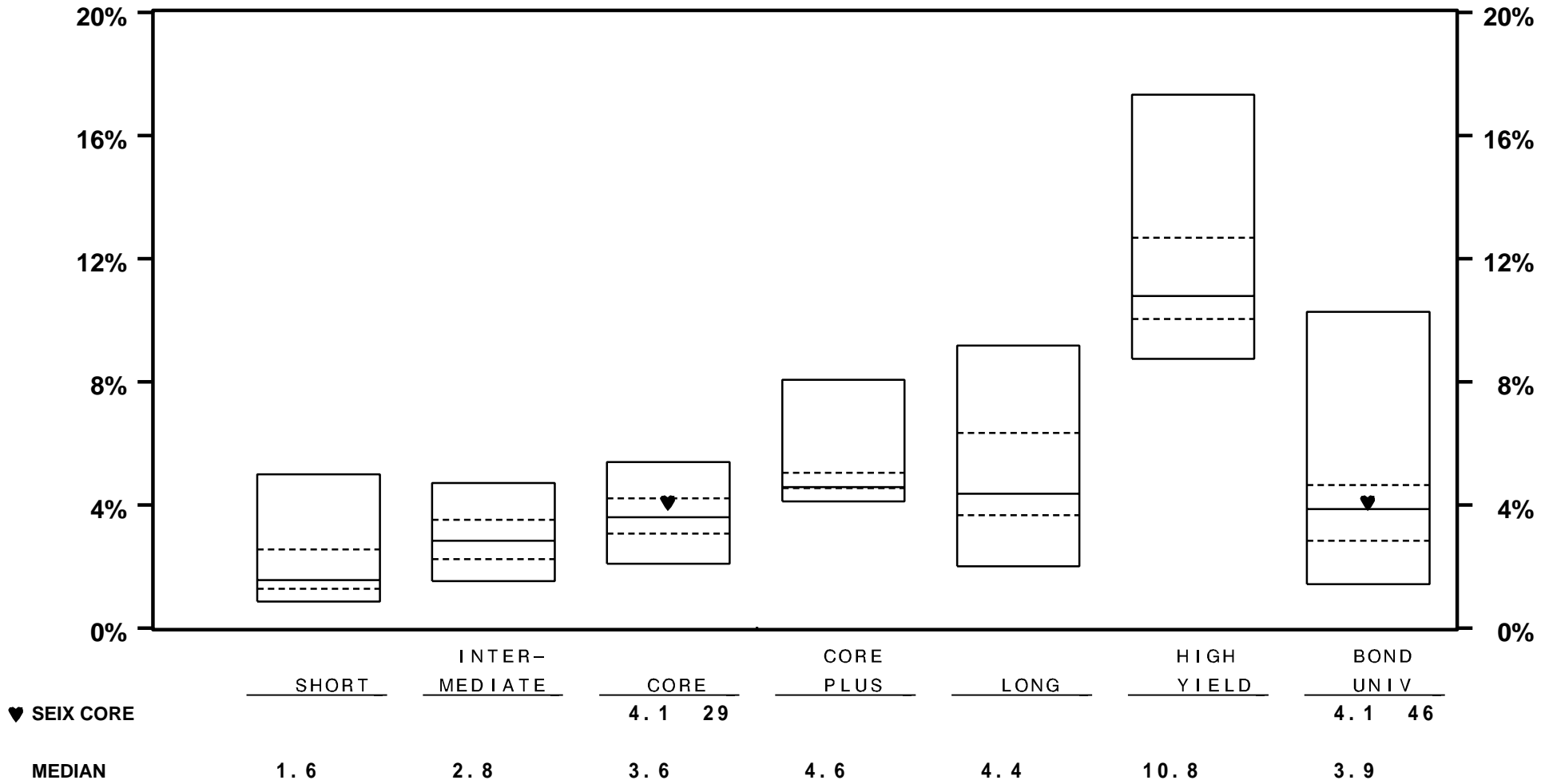

VERMONT MUNICIPAL EMPLOYEES

FIXED INCOME MANAGER STYLE ANALYSIS - TOTAL RETURNS

THREE YEARS ENDING 3/05

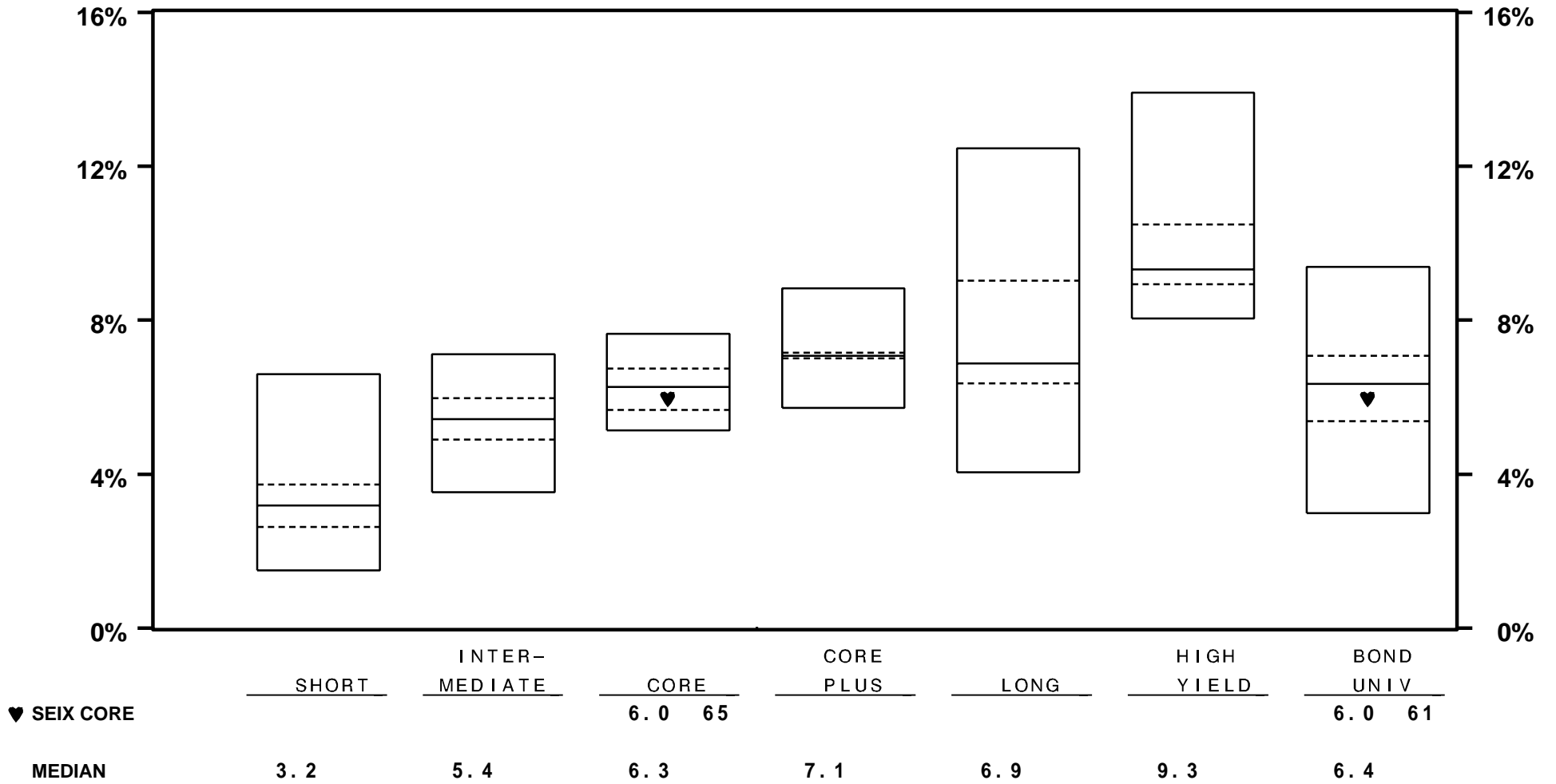

VERMONT MUNICIPAL EMPLOYEES

FIXED INCOME MANAGER STYLE ANALYSIS - TOTAL RETURNS

FOUR YEARS ENDING 3/05

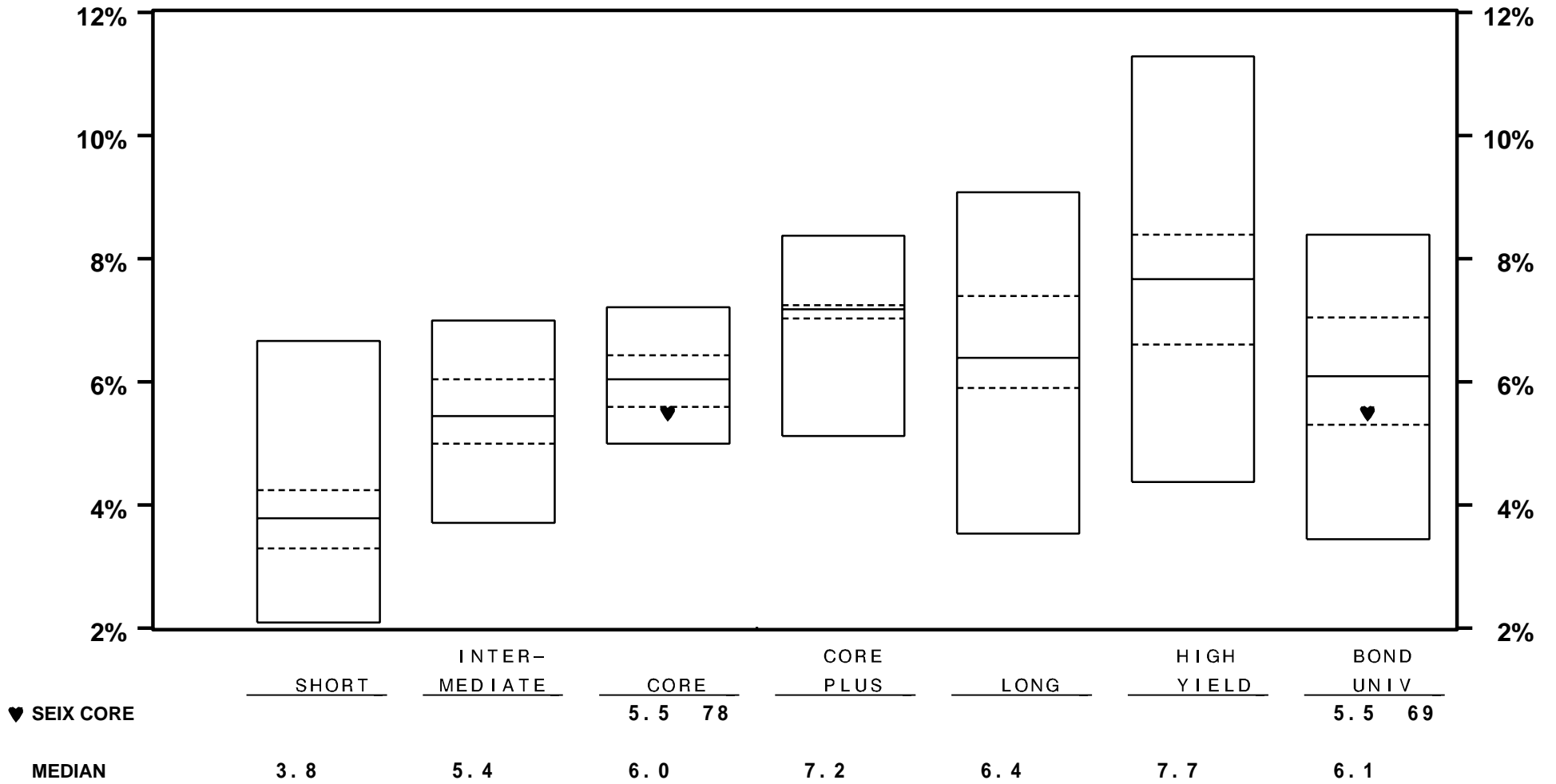

VERMONT MUNICIPAL EMPLOYEES

FIXED INCOME MANAGER STYLE ANALYSIS - TOTAL RETURNS

FIVE YEARS ENDING 3/05

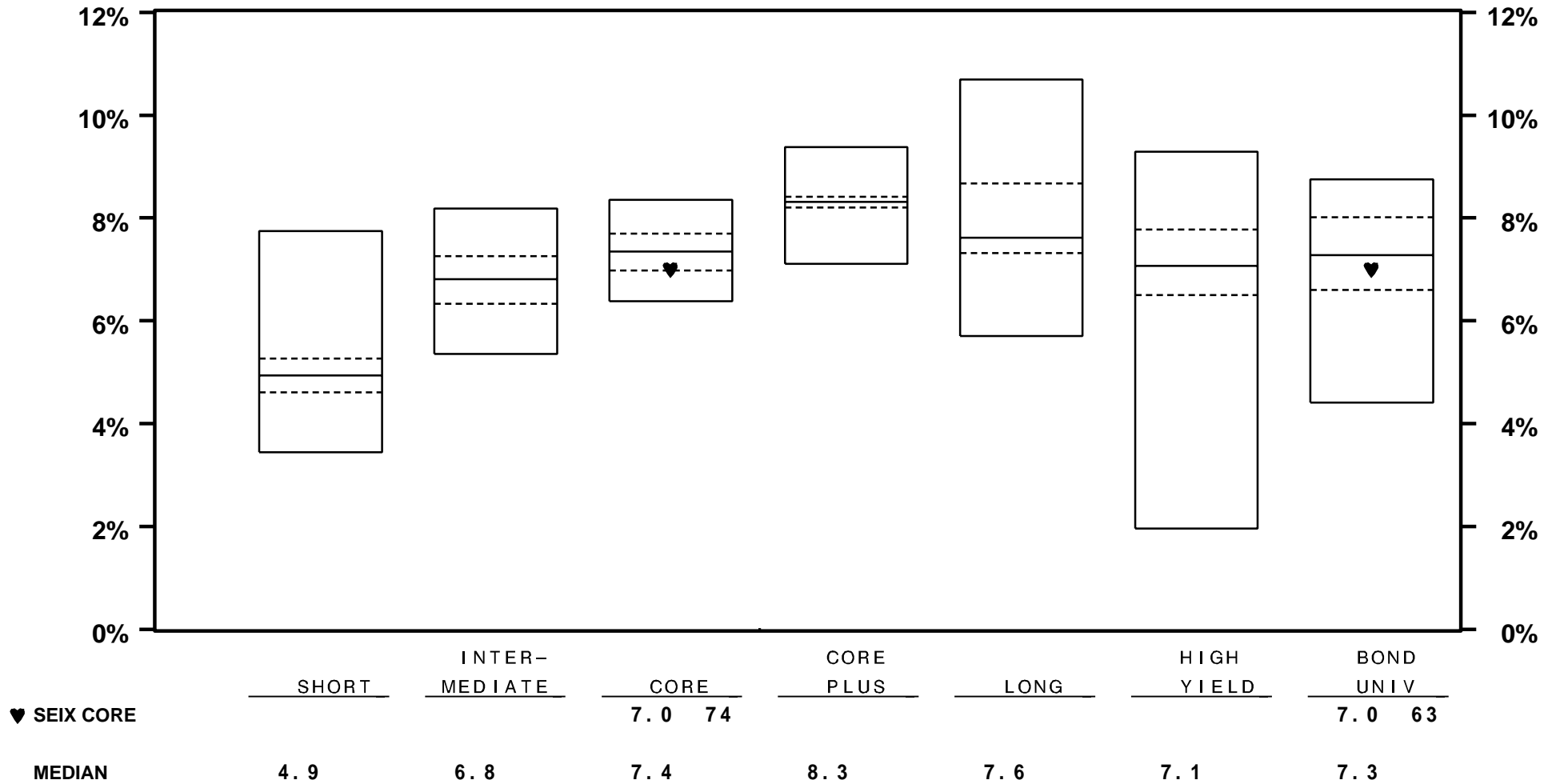

VERMONT MUNICIPAL EMPLOYEES

FIXED INCOME MANAGER STYLE ANALYSIS - BOND ONLY RETURNS

QUARTER ENDING 3/05

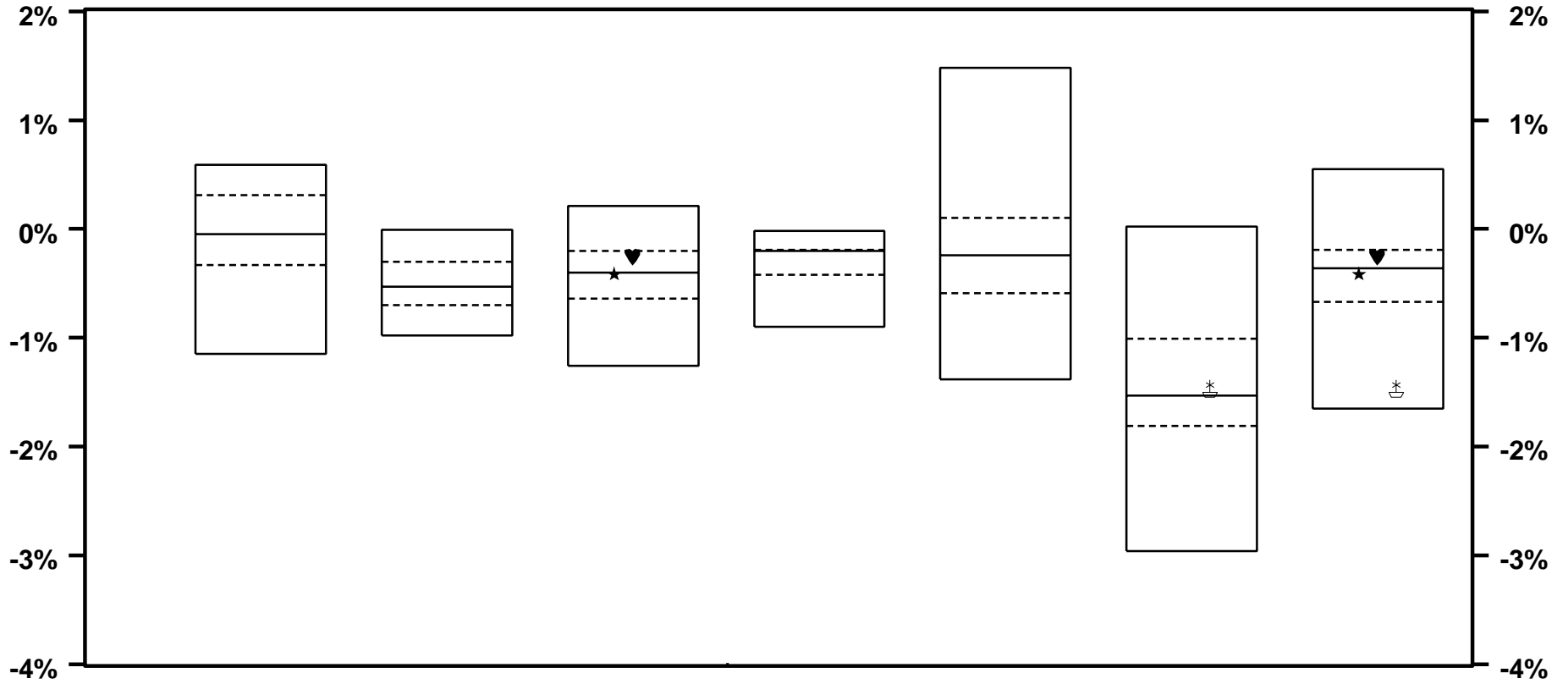

	SHORT	INTER-MEDIATE	CORE	CORE PLUS	LONG	HIGH YIELD	BOND UNIV
★ MUNI COMPOSITE			- 0.4 53				- 0.4 54
♥ SEIX CORE			- 0.3 34				- 0.3 39
⊕ SEIX HIGH YIELD						- 1.5 39	- 1.5 92
MEDIAN	- 0.1	- 0.5	- 0.4	- 0.2	- 0.2	- 1.5	- 0.4

VERMONT MUNICIPAL EMPLOYEES

FIXED INCOME MANAGER STYLE ANALYSIS - BOND ONLY RETURNS

YEAR ENDING 3/05

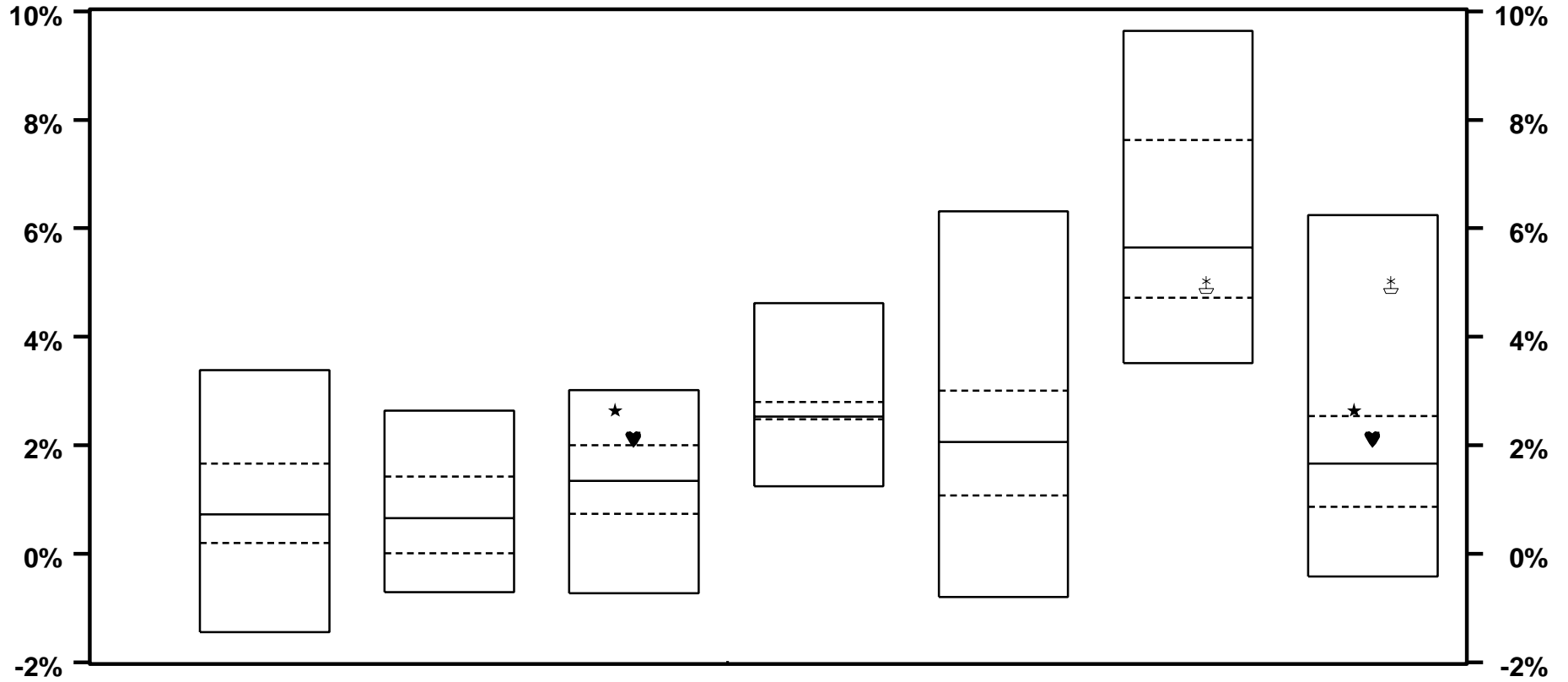

	SHORT	INTER-MEDIATE	CORE	CORE PLUS	LONG	HIGH YIELD	BOND UNIV
★ MUNI COMPOSITE			2.6				2.6
♥ SEIX CORE			2.1				2.1
⊠ SEIX HIGH YIELD						5.0	5.0
MEDIAN	0.7	0.7	1.3	2.5	2.1	5.7	1.7
			7			62	21
			21				38
							7

VERMONT MUNICIPAL EMPLOYEES

FIXED INCOME MANAGER STYLE ANALYSIS - BOND ONLY RETURNS

TWO YEARS ENDING 3/05

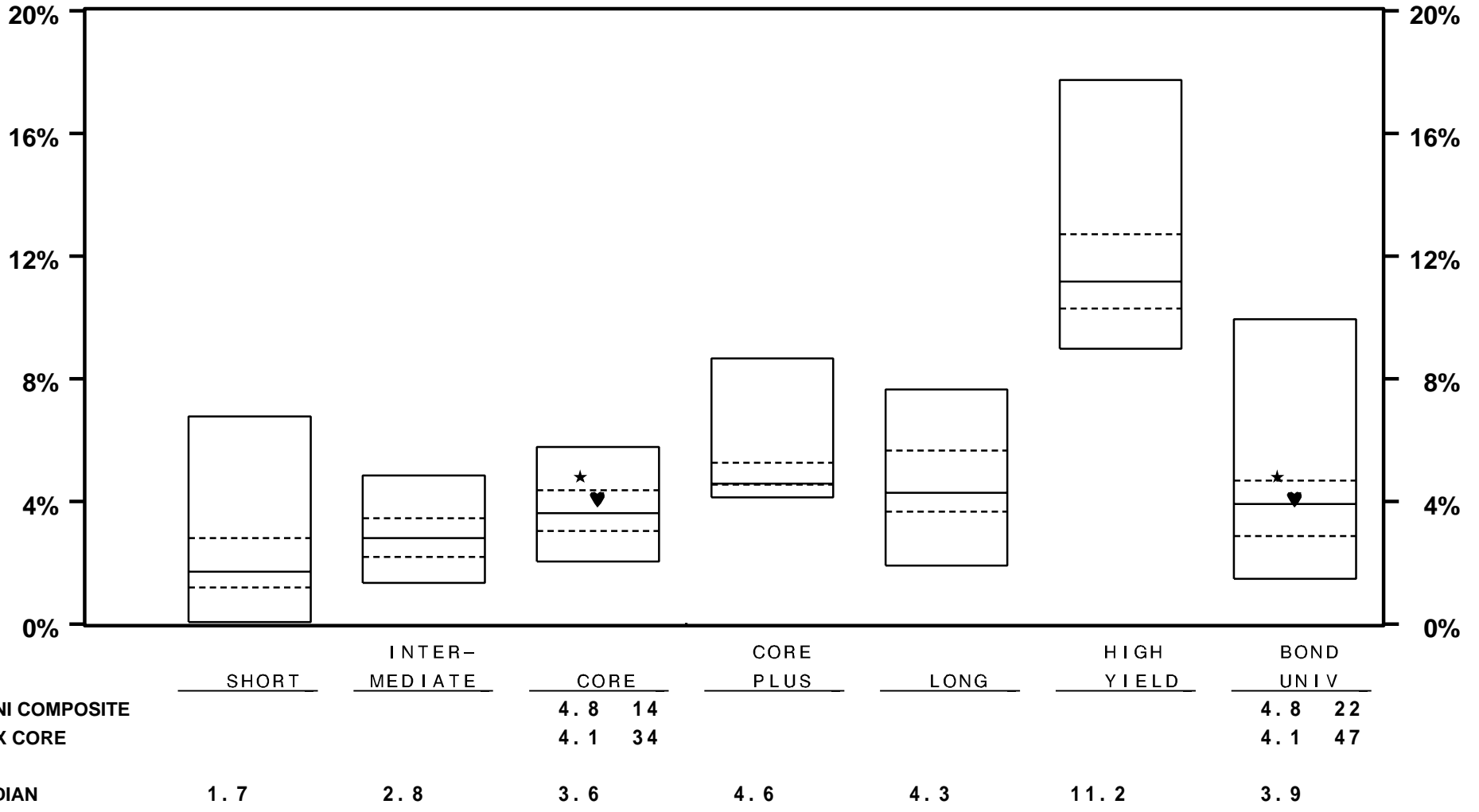

VERMONT MUNICIPAL EMPLOYEES

FIXED INCOME MANAGER STYLE ANALYSIS - BOND ONLY RETURNS

THREE YEARS ENDING 3/05

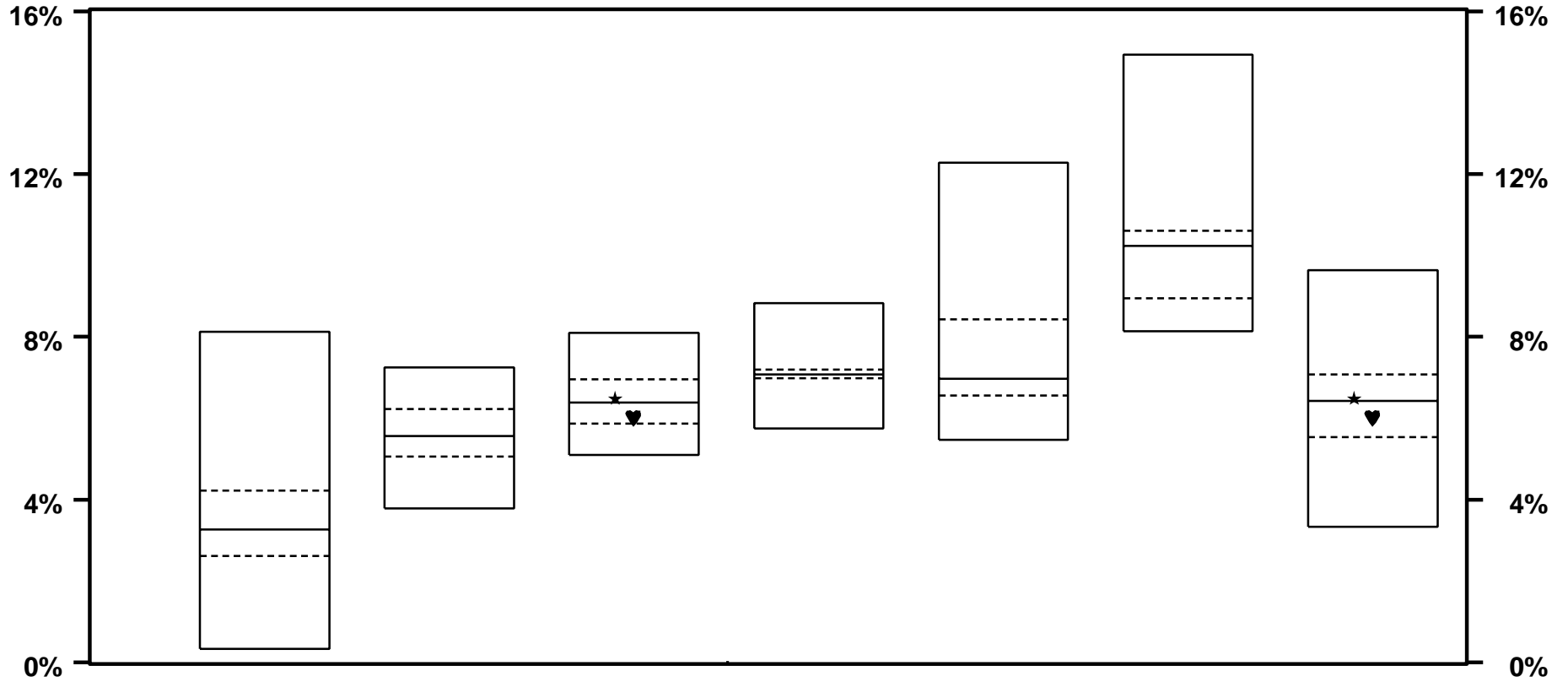

	SHORT	INTER-MEDIATE	CORE	CORE PLUS	LONG	HIGH YIELD	BOND UNIV
★ MUNI COMPOSITE			6.5 45				6.5 48
♥ SEIX CORE			6.0 67				6.0 62
MEDIAN	3.3	5.6	6.4	7.1	7.0	10.2	6.4

VERMONT MUNICIPAL EMPLOYEES

FIXED INCOME MANAGER STYLE ANALYSIS - BOND ONLY RETURNS

FOUR YEARS ENDING 3/05

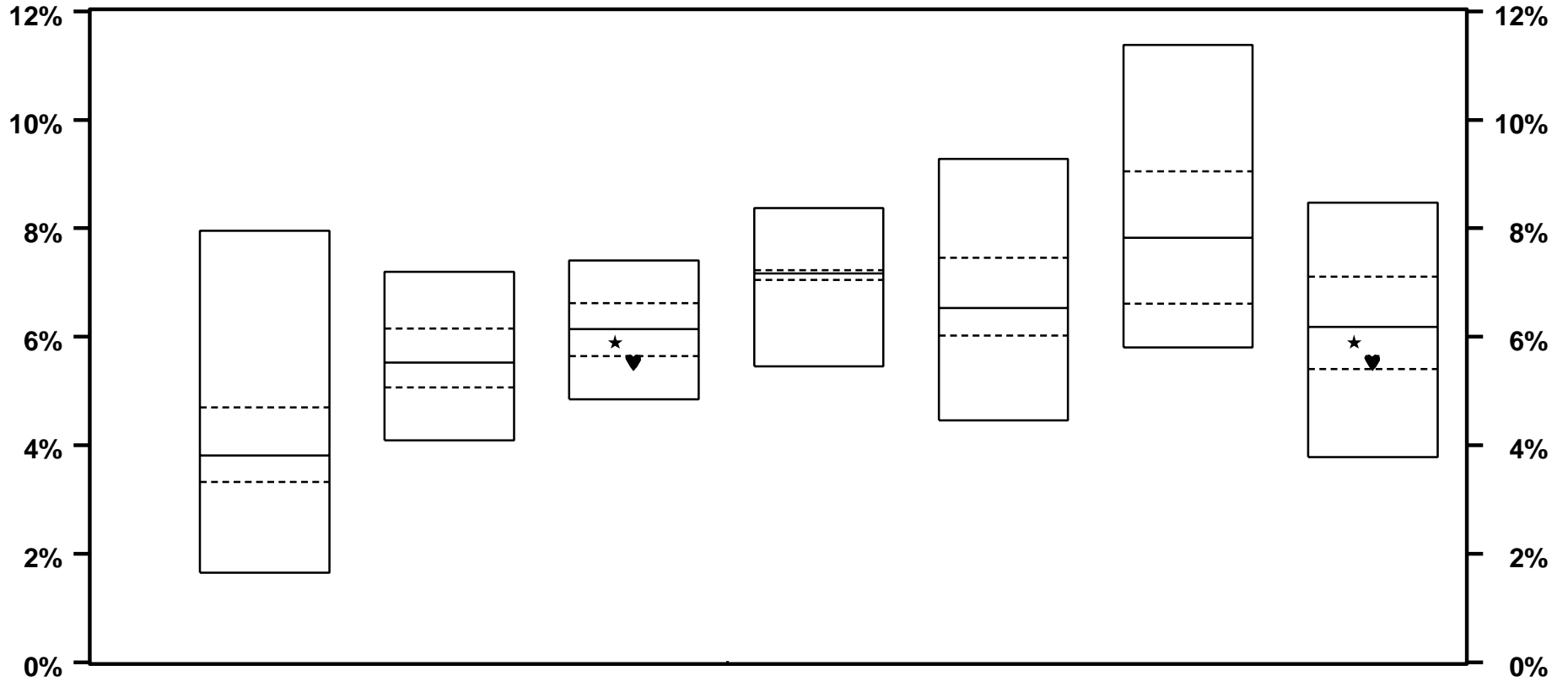

★ MUNI COMPOSITE
♥ SEIX CORE

CORE
5.9 60
5.5 81

BOND UNIV
5.9 58
5.5 71

MEDIAN 3.8 5.5 6.1 7.2 6.5 7.8 6.2

VERMONT MUNICIPAL EMPLOYEES

FIXED INCOME MANAGER STYLE ANALYSIS - BOND ONLY RETURNS

FIVE YEARS ENDING 3/05

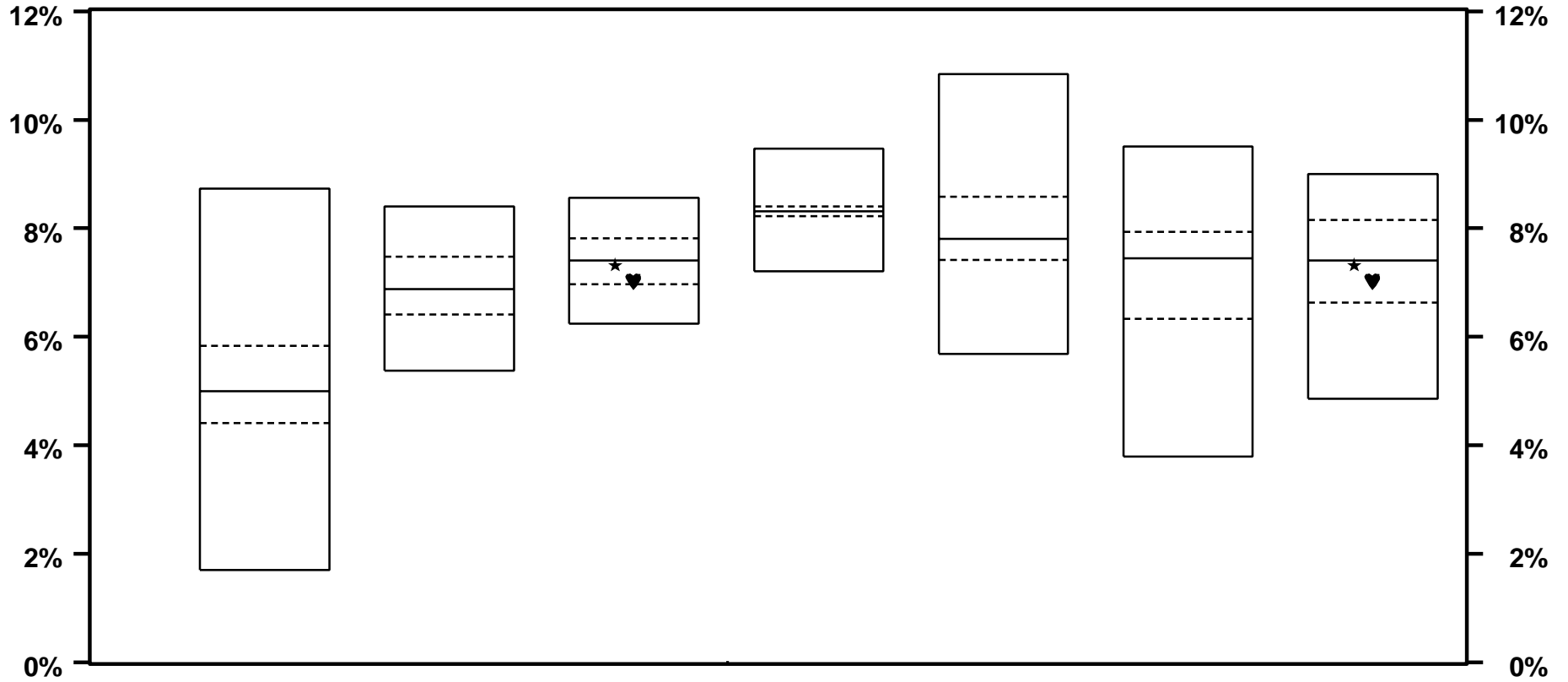

	SHORT	INTER-MEDIATE	CORE	CORE PLUS	LONG	HIGH YIELD	BOND UNIV
★ MUNI COMPOSITE			7.3 54				7.3 52
♥ SEIX CORE			7.0 70				7.0 64
MEDIAN	5.0	6.9	7.4	8.3	7.8	7.5	7.4

VERMONT MUNICIPAL EMPLOYEES

SOURCES OF PORTFOLIO GROWTH (\$000)

MUNICIPAL SYSTEM COMPOSITE

PERIOD ENDING	BEGINNING MARKET VALUE	NET CONTRIB	INCOME RECEIVED	GAIN (LOSS)	ENDING MARKET VALUE	TOTAL RETURN
6/00	169,188	2,083	0	669	171,940	0.4
9/00	171,940	-4,637	0	937	168,240	0.5
12/00	168,240	366	0	2,035	170,641	1.2
3/01	170,641	-25	0	-7,468	163,148	-4.4
6/01	163,148	3,226	837	4,904	172,115	3.5
9/01	172,115	472	848	-10,618	162,817	-5.7
12/01	162,817	243	513	9,484	173,055	6.1
3/02	173,055	1,135	490	2,296	176,977	1.6
6/02	176,977	857	761	-6,878	171,715	-3.5
9/02	171,715	994	1,201	-17,722	156,188	-9.7
12/02	156,188	2,089	759	6,029	165,064	4.3
3/03	165,064	5,941	868	-4,721	167,152	-2.3
6/03	167,152	270	799	17,100	185,321	10.7
9/03	185,321	664	891	5,261	192,137	3.3
12/03	192,137	2,358	970	14,746	210,212	8.1
3/04	210,212	2,901	831	4,250	218,194	2.4
6/04	218,194	1,635	694	203	220,726	0.4
9/04	220,726	1,004	1,139	-1,129	221,740	0.0
12/04	221,740	2,177	5,478	10,352	239,747	7.1
3/05	239,747	2,436	837	-4,205	238,815	-1.4

VERMONT MUNICIPAL EMPLOYEES

SOURCES OF PORTFOLIO GROWTH (\$000)

DOMESTIC EQUITY COMPOSITE

PERIOD ENDING	BEGINNING MARKET VALUE	NET CONTRIB	INCOME RECEIVED	GAIN (LOSS)	ENDING MARKET VALUE	TOTAL RETURN
6/00	74,396	0	0	-1,159	73,237	-1.6
9/00	73,237	0	0	698	73,935	1.0
12/00	73,935	1	0	-1,513	72,423	-2.1
3/01	72,423	0	0	-6,591	65,832	-9.1
6/01	65,832	-33	155	4,286	70,241	6.7
9/01	70,241	-30	172	-8,997	61,386	-12.6
12/01	61,386	14	143	8,272	69,816	13.7
3/02	69,816	-33	142	1,528	71,452	2.4
6/02	71,452	1,965	150	-7,660	65,908	-10.4
9/02	65,908	6,721	668	-11,998	61,299	-17.6
12/02	61,299	219	168	2,827	64,514	4.9
3/03	64,514	9,969	176	-2,633	72,027	-3.6
6/03	72,027	1,993	191	11,543	85,754	16.1
9/03	85,754	-40	207	3,577	89,499	4.4
12/03	89,499	-5,041	210	9,788	94,456	11.8
3/04	94,456	-44	219	2,102	96,733	2.5
6/04	96,733	957	147	1,704	99,540	1.9
9/04	99,540	-43	277	-3,479	96,296	-3.2
12/04	96,296	1,954	4,337	5,179	107,767	9.7
3/05	107,767	-2,049	229	-3,735	102,212	-3.3

VERMONT MUNICIPAL EMPLOYEES

SOURCES OF PORTFOLIO GROWTH (\$000)

DELAWARE

PERIOD ENDING	BEGINNING MARKET VALUE	NET CONTRIB	INCOME RECEIVED	GAIN (LOSS)	ENDING MARKET VALUE	TOTAL RETURN
6/00	24,227	0	0	25	24,252	0.1
9/00	24,252	0	0	2,102	26,354	8.7
12/00	26,354	0	0	2,630	28,984	10.0
3/01	28,984	0	0	-1,141	27,843	-3.9
6/01	27,843	0	155	926	28,925	3.9
9/01	28,925	0	160	-3,452	25,632	-11.4
12/01	25,632	49	143	2,049	27,874	8.6
3/02	27,874	0	142	1,406	29,422	5.5
6/02	29,422	0	149	-2,363	27,208	-7.5
9/02	27,208	0	152	-5,222	22,137	-18.6
12/02	22,137	0	161	1,611	23,909	8.0
3/03	23,909	4,500	176	-1,650	26,935	-5.4
6/03	26,935	1,527	191	4,819	33,472	18.2
9/03	33,472	1	207	648	34,329	2.6
12/03	34,329	-1,000	210	4,121	37,660	12.9
3/04	37,660	0	219	450	38,329	1.8
6/04	38,329	0	147	585	39,060	1.9
9/04	39,060	0	213	-672	38,601	-1.2
12/04	38,601	0	207	3,167	41,975	8.7
3/05	41,975	0	229	-766	41,437	-1.3

VERMONT MUNICIPAL EMPLOYEES

SOURCES OF PORTFOLIO GROWTH (\$000)

ALLIANCE LARGE CAP GROWTH FUND

PERIOD ENDING	BEGINNING MARKET VALUE	NET CONTRIB	INCOME RECEIVED	GAIN (LOSS)	ENDING MARKET VALUE	TOTAL RETURN
6/00	36,857	0	0	-1,207	35,650	-3.3
9/00	35,650	0	0	-2,072	33,578	-5.8
12/00	33,578	0	0	-4,985	28,593	-14.9
3/01	28,593	0	0	-4,990	23,603	-17.4
6/01	23,603	0	0	1,479	25,082	6.3
9/01	25,082	0	0	-3,889	21,193	-15.5
12/01	21,193	0	0	3,222	24,415	15.2
3/02	24,415	0	0	-1,130	23,285	-4.6
6/02	23,285	2,000	1	-3,597	21,689	-14.9
9/02	21,689	4,750	9	-2,949	23,499	-15.0
12/02	23,499	250	6	413	24,168	1.8
3/03	24,168	4,500	0	-181	28,487	-1.1
6/03	28,487	0	0	3,620	32,107	12.7
9/03	32,107	0	0	1,262	33,369	3.9
12/03	33,369	-2,000	0	2,753	34,121	8.8
3/04	34,121	0	0	549	34,671	1.6
6/04	34,671	1,000	0	639	36,310	1.8
9/04	36,310	0	0	-2,084	34,225	-5.7
12/04	34,225	2,000	0	3,343	39,569	9.2
3/05	39,569	0	0	-2,453	37,116	-6.2

VERMONT MUNICIPAL EMPLOYEES

SOURCES OF PORTFOLIO GROWTH (\$000)

LAZARD SMALL CAP FUND

PERIOD ENDING	BEGINNING MARKET VALUE	NET CONTRIB	INCOME RECEIVED	GAIN (LOSS)	ENDING MARKET VALUE	TOTAL RETURN
6/00	13,312	0	0	23	13,335	0.2
9/00	13,335	0	0	668	14,003	5.0
12/00	14,003	0	0	843	14,846	6.0
3/01	14,846	0	0	-460	14,386	-2.9
6/01	14,386	-33	0	1,882	16,234	13.1
9/01	16,234	-30	13	-1,656	14,562	-10.1
12/01	14,562	-36	0	3,001	17,527	20.6
3/02	17,527	-33	0	1,252	18,746	7.2
6/02	18,746	-35	0	-1,699	17,012	-9.1
9/02	17,012	1,971	507	-3,827	15,664	-19.3
12/02	15,664	-31	0	804	16,437	5.1
3/03	16,437	969	0	-801	16,605	-4.9
6/03	16,605	466	0	3,103	20,174	18.4
9/03	20,174	-40	0	1,667	21,801	8.3
12/03	21,801	-2,041	0	2,914	22,675	14.7
3/04	22,675	-44	0	1,103	23,733	4.9
6/04	23,733	-43	0	480	24,171	1.7
9/04	24,171	-44	65	-722	23,469	-2.7
12/04	23,469	-46	4,130	-1,331	26,223	11.9
3/05	26,223	-2,049	0	-516	23,659	-1.8

VERMONT MUNICIPAL EMPLOYEES

SOURCES OF PORTFOLIO GROWTH (\$000)

BRINSON - UBS

PERIOD ENDING	BEGINNING MARKET VALUE	NET CONTRIB	INCOME RECEIVED	GAIN (LOSS)	ENDING MARKET VALUE	TOTAL RETURN
6/00	26,222	0	0	173	26,395	0.7
9/00	26,395	-25	0	-1,922	24,448	-7.3
12/00	24,448	0	0	469	24,917	1.9
3/01	24,917	9,000	0	-2,923	30,994	-11.7
6/01	30,994	-12	4	638	31,624	2.1
9/01	31,624	0	0	-3,480	28,143	-11.0
12/01	28,143	0	0	2,158	30,301	7.7
3/02	30,301	0	0	1,006	31,307	3.3
6/02	31,307	2,000	0	-145	33,163	-0.3
9/02	33,163	3,000	0	-6,800	29,363	-20.3
12/02	29,363	0	1	2,620	31,984	8.9
3/03	31,984	-6,000	0	-2,502	23,482	-8.1
6/03	23,482	495	0	4,288	28,265	18.2
9/03	28,265	0	0	1,955	30,220	6.9
12/03	30,220	0	0	4,931	35,152	16.3
3/04	35,152	0	0	985	36,136	2.8
6/04	36,136	-6	0	-58	36,073	-0.2
9/04	36,073	0	0	566	36,639	1.6
12/04	36,639	0	0	5,249	41,888	14.3
3/05	41,888	-2,000	-4	-161	39,723	-0.4

VERMONT MUNICIPAL EMPLOYEES

SOURCES OF PORTFOLIO GROWTH (\$000)

MET LIFE / SSR TOWER FUND

PERIOD ENDING	BEGINNING MARKET VALUE	NET CONTRIB	INCOME RECEIVED	GAIN (LOSS)	ENDING MARKET VALUE	TOTAL RETURN
6/00	11,208	-118	0	265	11,355	2.3
9/00	11,355	0	0	317	11,672	2.8
12/00	11,672	0	0	509	12,181	4.4
3/01	12,181	0	0	222	12,403	1.8
6/01	12,403	-2	0	228	12,628	1.8
9/01	12,628	0	0	70	12,698	0.6
12/01	12,698	-38	0	79	12,740	0.6
3/02	12,740	-38	0	4	12,705	0.0
6/02	12,705	-38	262	-147	12,782	0.9
9/02	12,782	-37	242	-189	12,799	0.4
12/02	12,799	18	218	-146	12,889	0.6
3/03	12,889	-31	226	2	13,086	1.8
6/03	13,086	-33	232	48	13,334	2.1
9/03	13,334	-34	0	321	13,621	2.4
12/03	13,621	-35	219	-144	13,660	0.6
3/04	13,660	-34	0	140	13,767	1.0
6/04	13,767	-35	0	393	14,125	2.9
9/04	14,125	-42	0	22	14,106	0.2
12/04	14,106	-42	0	340	14,404	2.4
3/05	14,404	2,000	0	598	17,003	4.1

VERMONT MUNICIPAL EMPLOYEES

SOURCES OF PORTFOLIO GROWTH (\$000)

SEIX CORE

PERIOD ENDING	BEGINNING MARKET VALUE	NET CONTRIB	INCOME RECEIVED	GAIN (LOSS)	ENDING MARKET VALUE	TOTAL RETURN
6/00	52,397	10	0	959	53,366	1.8
9/00	53,366	-1	0	1,741	55,106	3.3
12/00	55,106	-1	0	2,505	57,610	4.5
3/01	57,610	-7,003	0	1,730	52,337	3.0
6/01	52,337	44	598	-256	52,723	0.6
9/01	52,723	1	631	1,780	55,136	4.6
12/01	55,136	-1	352	-1,025	54,463	-1.2
3/02	54,463	0	307	-230	54,540	0.1
6/02	54,540	0	331	1,279	56,150	3.0
9/02	56,150	-8,000	259	1,238	49,647	2.7
12/02	49,647	0	364	729	50,740	2.2
3/03	50,740	3,000	436	464	54,640	1.7
6/03	54,640	-8,500	374	1,220	47,733	2.9
9/03	47,733	0	635	-645	47,723	0.0
12/03	47,723	4,000	333	-90	51,967	0.5
3/04	51,967	0	433	942	53,342	2.6
6/04	53,342	6,000	314	-1,441	58,214	-2.0
9/04	58,214	1,500	648	1,434	61,797	3.5
12/04	61,797	500	323	223	62,842	0.9
3/05	62,842	3,000	413	-557	65,698	-0.3

VERMONT MUNICIPAL EMPLOYEES

SOURCES OF PORTFOLIO GROWTH (\$000)

SEIX HIGH YIELD

PERIOD ENDING	BEGINNING MARKET VALUE	NET CONTRIB	INCOME RECEIVED	GAIN (LOSS)	ENDING MARKET VALUE	TOTAL RETURN
6 / 00						
9 / 00						
12 / 00						
3 / 01						
6 / 01						
9 / 01						
12 / 01						
3 / 02						
6 / 02						
9 / 02						
12 / 02						
3 / 03						
6 / 03		9,000		55	9,055	
9 / 03	9,055	- 12	48	46	9,137	1.1
12 / 03	9,137	986	191	263	10,579	4.5
3 / 04	10,579	- 15	169	71	10,804	2.3
6 / 04	10,804	- 15	163	- 321	10,632	- 1.5
9 / 04	10,632	- 15	181	347	11,145	5.0
12 / 04	11,145	- 16	306	25	11,461	3.0
3 / 05	11,461	984	179	- 356	12,269	- 1.5

VERMONT MUNICIPAL EMPLOYEES
SOURCES OF PORTFOLIO GROWTH (\$000)

ALTERNATIVE INVESTMENTS

PERIOD ENDING	BEGINNING MARKET VALUE	NET CONTRIB	INCOME RECEIVED	GAIN (LOSS)	ENDING MARKET VALUE	TOTAL RETURN
6/ 00	674	0	0	362	1,036	53.7
9/ 00	1,036	0	0	0	1,036	0.0
12/ 00	1,036	0	0	1	1,037	0.0
3/ 01	1,037	0	0	19	1,056	1.9
6/ 01	1,056	0	60	0	1,117	5.7
9/ 01	1,117	0	1	0	1,117	0.1
12/ 01	1,117	0	1	0	1,118	0.0
3/ 02	1,118	0	0	0	1,118	0.0
6/ 02	1,118	0	0	- 232	887	- 20.7
9/ 02	887	0	0	0	887	0.0
12/ 02	887	0	0	0	888	0.0
3/ 03	888	0	0	0	888	0.0
6/ 03	888	0	0	- 59	829	- 6.6
9/ 03	829	0	0	0	830	0.0
12/ 03	830	0	0	0	830	0.0
3/ 04	830	0	0	0	830	0.0
6/ 04	830	0	0	0	830	0.0
9/ 04	830	0	0	0	831	0.0
12/ 04	831	80	0	- 171	740	- 18.7
3/ 05	740	0	1	0	741	0.1

VERMONT MUNICIPAL EMPLOYEES

SOURCES OF PORTFOLIO GROWTH (\$000)

VERMONT INVESTMENTS

PERIOD ENDING	BEGINNING MARKET VALUE	NET CONTRIB	INCOME RECEIVED	GAIN (LOSS)	ENDING MARKET VALUE	TOTAL RETURN
6/00	4,291	2,191	0	69	6,551	1.4
9/00	6,551	-4,611	0	104	2,044	1.9
12/00	2,044	366	0	63	2,473	2.1
3/01	2,473	-2,022	0	75	526	2.6
6/01	526	3,229	20	8	3,782	1.1
9/01	3,782	500	44	9	4,335	1.3
12/01	4,335	267	17	-1	4,619	0.4
3/02	4,619	1,206	41	-12	5,854	0.6
6/02	5,854	-3,071	17	25	2,825	0.9
9/02	2,825	-690	31	28	2,193	1.8
12/02	2,193	1,851	9	-2	4,050	0.1
3/03	4,050	-997	30	-54	3,030	-0.8
6/03	3,030	-2,685	1	5	351	0.6
9/03	351	750	0	7	1,108	1.3
12/03	1,108	2,447	16	-2	3,569	0.5
3/04	3,569	2,994	10	9	6,581	0.4
6/04	6,581	-5,267	71	-74	1,311	-0.3
9/04	1,311	-396	32	-20	926	0.8
12/04	926	-300	512	-494	645	1.1
3/05	645	500	20	5	1,170	1.8

VERMONT MUNICIPAL EMPLOYEES

PORTFOLIO ASSET GROWTH BY SEGMENT (\$000)

QUARTER ENDING 3/05

<u>PORTFOLIO</u>	<u>BEGINNING VALUE</u>	<u>NET CONTR</u>	<u>INCOME RECEIVED</u>	<u>GAIN (LOSS)</u>	<u>END VALUE</u>
MUNI COMPOSITE	239,747	2,436	837	-4,205	238,815
COMMON STOCK	107,767	-2,280	229	-3,735	101,980
INT'L C/S	41,880	-2,000	0	-165	39,715
BONDS	74,617	3,984	592	-909	78,283
CASH EQUIV	498	732	17	6	1,252
REAL ESTATE	14,404	2,000	0	598	17,003
PRIVATE INVEST	582	0	0	0	582
EQTY COMPOSITE	107,767	-2,049	229	-3,735	102,212
COMMON STOCK	107,767	-2,280	229	-3,735	101,980
CASH EQUIV	0	232	0	0	232
DELAWARE	41,975	0	229	-766	41,437
COMMON STOCK	41,975	-232	229	-766	41,206
CASH EQUIV	0	232	0	0	232
ALLIANCE	39,569	0	0	-2,453	37,116
COMMON STOCK	39,569	0	0	-2,453	37,116
LAZARD	26,223	-2,049	0	-516	23,659
COMMON STOCK	26,223	-2,049	0	-516	23,659

VERMONT MUNICIPAL EMPLOYEES

PORTFOLIO ASSET GROWTH BY SEGMENT (\$000)

QUARTER ENDING 3/05

<u>PORTFOLIO</u>	<u>BEGINNING VALUE</u>	<u>NET CONTR</u>	<u>INCOME RECEIVED</u>	<u>GAIN (LOSS)</u>	<u>END VALUE</u>
UBS	41,888	- 2,000	- 4	- 161	39,723
INT'L C/S	41,880	- 2,000	0	- 165	39,715
CASH EQUIV	8	0	- 4	4	8
SSR TOWER FUND	14,404	2,000	0	598	17,003
REAL ESTATE	14,404	2,000	0	598	17,003
SEIX CORE	62,842	3,000	413	- 557	65,698
BONDS	62,842	3,000	413	- 557	65,698
SEIX HIGH YIELD	11,461	984	179	- 356	12,269
BONDS	11,461	984	179	- 356	12,269
ALT. ASSETS	740	0	1	0	741
CASH EQUIV	158	0	1	0	159
PRIVATE INVEST	582	0	0	0	582
VERMONT INVEST	645	500	20	5	1,170
BONDS	313	0	0	3	317
CASH EQUIV	331	500	20	2	853

VERMONT MUNICIPAL EMPLOYEES

PORTFOLIO ASSET GROWTH BY SEGMENT (\$000)

YEAR ENDING 3/05

<u>PORTFOLIO</u>	<u>BEGINNING VALUE</u>	<u>NET CONTR</u>	<u>INCOME RECEIVED</u>	<u>GAIN (LOSS)</u>	<u>END VALUE</u>
MUNI COMPOSITE	218,194	7,252	8,148	5,221	238,815
COMMON STOCK	96,733	588	4,989	-330	101,980
INT'L C/S	36,129	-2,006	0	5,592	39,715
BONDS	64,485	11,908	2,620	-730	78,283
CASH EQUIV	6,328	-5,121	539	-494	1,252
REAL ESTATE	13,767	1,882	0	1,354	17,003
PRIVATE INVEST	753	0	0	-171	582
EQTY COMPOSITE	96,733	820	4,989	-330	102,212
COMMON STOCK	96,733	588	4,989	-330	101,980
CASH EQUIV	0	232	0	0	232
DELAWARE	38,329	0	795	2,313	41,437
COMMON STOCK	38,329	-231	795	2,313	41,206
CASH EQUIV	0	232	0	0	232
ALLIANCE	34,671	3,000	0	-555	37,116
COMMON STOCK	34,671	3,000	0	-555	37,116
LAZARD	23,733	-2,181	4,195	-2,089	23,659
COMMON STOCK	23,733	-2,181	4,195	-2,089	23,659

VERMONT MUNICIPAL EMPLOYEES

PORTFOLIO ASSET GROWTH BY SEGMENT (\$000)

YEAR ENDING 3/05

<u>PORTFOLIO</u>	<u>BEGINNING VALUE</u>	<u>NET CONTR</u>	<u>INCOME RECEIVED</u>	<u>GAIN (LOSS)</u>	<u>END VALUE</u>
UBS	36,136	- 2,006	- 4	5,596	39,723
INT'L C/S	36,129	- 2,006	0	5,592	39,715
CASH EQUIV	8	0	- 4	4	8
SSR TOWER FUND	13,767	1,882	0	1,354	17,003
REAL ESTATE	13,767	1,882	0	1,354	17,003
SEIX CORE	53,342	11,000	1,697	- 341	65,698
BONDS	53,342	11,000	1,697	- 341	65,698
SEIX HIGH YIELD	10,804	939	829	- 304	12,269
BONDS	10,804	939	829	- 304	12,269
ALT. ASSETS	830	80	1	- 171	741
CASH EQUIV	77	80	1	0	159
PRIVATE INVEST	753	0	0	- 171	582
VERMONT INVEST	6,581	- 5,463	635	- 583	1,170
BONDS	339	- 31	94	- 85	317
CASH EQUIV	6,243	- 5,433	541	- 498	853

VERMONT MUNICIPAL EMPLOYEES
PERFORMANCE ANALYSIS
MUNICIPAL SYSTEM COMPOSITE

PERIODS ENDING 3/05

	<u>LAST QTR</u>		<u>LAST 2 QTRS</u>		<u>LAST 3 QTRS</u>		<u>LAST YEAR</u>		<u>LAST 3 YEARS</u>		<u>LAST 5 YEARS</u>	
TOTAL FUND	- 1.4	76	5.6	64	5.6	65	6.0	58	6.1	58	4.2	36
ALLOCATION IDX	- 1.5	79	6.4	48	6.8	42	6.8	42	7.1	34	2.2	73
MEDIAN	- 0.9		6.4		6.4		6.5		6.4		3.5	
EQUITIES	- 3.3	74	6.1	81	2.7	80	4.6	76	2.7	77	0.8	50
S&P 500	- 2.1	55	6.9	73	4.9	64	6.7	63	2.8	76	- 3.2	73
R 1000(R) GR	- 4.1	80	4.7	88	- 0.8	91	1.2	89	- 0.7	92	- 11.3	96
R 1000(R) VALUE	0.1	19	10.5	29	12.2	15	13.2	19	7.2	34	5.2	36
R 2000(R)	- 5.3	88	8.0	55	4.9	63	5.4	73	8.0	29	4.0	39
MEDIAN	- 2.1		8.6		5.9		7.4		4.8		1.0	
BONDS	- 0.4	54	0.8	47	4.6	31	2.6	21	6.5	48	7.3	52
LB AGGREGATE	- 0.5	60	0.5	65	3.7	58	1.2	66	6.0	63	7.1	60
ML HIGH YLD II	- 1.4	92	3.0	4	7.8	4	6.9	3	10.5	2	6.7	72
MEDIAN	- 0.4		0.8		4.0		1.7		6.4		7.4	
INT'L EQUITIES	- 0.4	77	13.9	77	15.7	39	15.5	43	11.6	56		
MS EAFE NET	- 0.2	69	15.1	46	14.8	60	15.1	49	11.6	51	- 1.1	80
CITI PMI EPAC	- 0.1	68	15.4	39	15.3	44	15.2	49	11.9	50	- 0.6	75
MEDIAN	0.2		15.0		15.0		15.0		12.0		2.6	

VERMONT MUNICIPAL EMPLOYEES
PERFORMANCE ANALYSIS
MUNI POLICY INDEX

PERIODS ENDING 3/05

	LAST QTR		LAST 2 QTRS		LAST 3 QTRS		LAST YEAR		LAST 3 YEARS		LAST 5 YEARS	
TOTAL FUND	- 1.3	72	6.1	55	6.7	44	6.8	44	6.9	38	2.7	67
MEDIAN	- 0.9		6.4		6.4		6.5		6.4		3.5	

VERMONT MUNICIPAL EMPLOYEES
PERFORMANCE ANALYSIS
DOMESTIC EQUITY COMPOSITE

PERIODS ENDING 3/05

	<u>LAST QTR</u>		<u>LAST 2 QTRS</u>		<u>LAST 3 QTRS</u>		<u>LAST YEAR</u>		<u>LAST 3 YEARS</u>		<u>LAST 5 YEARS</u>	
TOTAL FUND	- 3.3	74	6.1	79	2.7	78	4.6	75	2.8	76	0.9	50
ALLOCATION IDX	- 2.8	69	7.8	56	5.6	51	6.9	54	4.0	56	- 2.6	62
MEDIAN	- 2.0		8.4		5.7		7.3		4.8		0.9	
EQUITIES	- 3.3	74	6.1	81	2.7	80	4.6	76	2.7	77	0.8	50
S&P 500	- 2.1	55	6.9	73	4.9	64	6.7	63	2.8	76	- 3.2	73
R 1000(R) GR	- 4.1	80	4.7	88	- 0.8	91	1.2	89	- 0.7	92	- 11.3	96
R 1000(R) VALUE	0.1	19	10.5	29	12.2	15	13.2	19	7.2	34	5.2	36
R 2000(R)	- 5.3	88	8.0	55	4.9	63	5.4	73	8.0	29	4.0	39
MEDIAN	- 2.1		8.6		5.9		7.4		4.8		1.0	

VERMONT MUNICIPAL EMPLOYEES
PERFORMANCE ANALYSIS
DELAWARE

PERIODS ENDING 3/05

	<u>LAST QTR</u>		<u>LAST 2 QTRS</u>		<u>LAST 3 QTRS</u>		<u>LAST YEAR</u>		<u>LAST 3 YEARS</u>		<u>LAST 5 YEARS</u>	
TOTAL FUND	- 1.3	36	7.3	61	6.1	47	8.1	43	5.0	48	7.0	31
ALLOCATION IDX	0.1	19	10.5	27	12.2	14	13.2	18	5.9	42	2.4	46
MEDIAN	- 2.0		8.4		5.7		7.3		4.8		0.9	
EQUITIES	- 1.3	34	7.4	63	6.1	48	8.2	44	5.0	49	7.0	30
S&P 500	- 2.1	55	6.9	73	4.9	64	6.7	63	2.8	76	- 3.2	73
R 1000(R) GR	- 4.1	80	4.7	88	- 0.8	91	1.2	89	- 0.7	92	- 11.3	96
R 1000(R) VALUE	0.1	19	10.5	29	12.2	15	13.2	19	7.2	34	5.2	36
R 2000(R)	- 5.3	88	8.0	55	4.9	63	5.4	73	8.0	29	4.0	39
MEDIAN	- 2.1		8.6		5.9		7.4		4.8		1.0	

VERMONT MUNICIPAL EMPLOYEES
PERFORMANCE ANALYSIS
ALLIANCE LARGE CAP GROWTH FUND

PERIODS ENDING 3/05

	<u>LAST QTR</u>		<u>LAST 2 QTRS</u>		<u>LAST 3 QTRS</u>		<u>LAST YEAR</u>		<u>LAST 3 YEARS</u>		<u>LAST 5 YEARS</u>	
TOTAL FUND	- 6.2	92	2.5	94	- 3.4	96	- 1.7	96	- 2.5	99	- 10.1	95
ALLOCATION IDX	- 4.1	81	4.7	86	- 0.8	91	1.2	88	- 0.8	93	- 11.3	97
MEDIAN	- 2.0		8.4		5.7		7.3		4.8		0.9	
EQUITIES	- 6.2	91	2.5	96	- 3.4	96	- 1.7	95	- 2.5	98	- 10.1	94
S&P 500	- 2.1	55	6.9	73	4.9	64	6.7	63	2.8	76	- 3.2	73
R 1000(R) GR	- 4.1	80	4.7	88	- 0.8	91	1.2	89	- 0.7	92	- 11.3	96
R 1000(R) VALUE	0.1	19	10.5	29	12.2	15	13.2	19	7.2	34	5.2	36
R 2000(R)	- 5.3	88	8.0	55	4.9	63	5.4	73	8.0	29	4.0	39
MEDIAN	- 2.1		8.6		5.9		7.4		4.8		1.0	

VERMONT MUNICIPAL EMPLOYEES
PERFORMANCE ANALYSIS
LAZARD SMALL CAP FUND

PERIODS ENDING 3/05

	<u>LAST QTR</u>		<u>LAST 2 QTRS</u>		<u>LAST 3 QTRS</u>		<u>LAST YEAR</u>		<u>LAST 3 YEARS</u>		<u>LAST 5 YEARS</u>	
TOTAL FUND	- 1.8	46	9.9	33	6.9	41	8.7	39	7.2	33	11.9	19
ALLOCATION IDX	- 5.3	89	8.0	53	4.9	62	5.4	71	8.0	29	4.0	41
MEDIAN	- 2.0		8.4		5.7		7.3		4.8		0.9	
EQUITIES	- 1.8	45	9.9	35	6.9	43	8.7	41	7.2	34	11.8	20
S&P 500	- 2.1	55	6.9	73	4.9	64	6.7	63	2.8	76	- 3.2	73
R 1000(R) GR	- 4.1	80	4.7	88	- 0.8	91	1.2	89	- 0.7	92	- 11.3	96
R 1000(R) VALUE	0.1	19	10.5	29	12.2	15	13.2	19	7.2	34	5.2	36
R 2000(R)	- 5.3	88	8.0	55	4.9	63	5.4	73	8.0	29	4.0	39
MEDIAN	- 2.1		8.6		5.9		7.4		4.8		1.0	

VERMONT MUNICIPAL EMPLOYEES
PERFORMANCE ANALYSIS
SEIX CORE

PERIODS ENDING 3/05

	<u>LAST QTR</u>		<u>LAST 2 QTRS</u>		<u>LAST 3 QTRS</u>		<u>LAST YEAR</u>		<u>LAST 3 YEARS</u>		<u>LAST 5 YEARS</u>	
TOTAL FUND	- 0.3	44	0.6	60	4.2	42	2.1	40	6.0	61	7.0	63
ALLOCATION IDX	- 0.5	66	0.5	70	3.7	58	1.2	69	6.0	60	7.1	56
MEDIAN	- 0.3		0.9		3.9		1.8		6.4		7.3	
BONDS	- 0.3	39	0.6	55	4.2	43	2.1	38	6.0	62	7.0	64
LB AGGREGATE	- 0.5	60	0.5	65	3.7	58	1.2	66	6.0	63	7.1	60
ML HIGH YLD II	- 1.4	92	3.0	4	7.8	4	6.9	3	10.5	2	6.7	72
MEDIAN	- 0.4		0.8		4.0		1.7		6.4		7.4	

VERMONT MUNICIPAL EMPLOYEES

PERFORMANCE ANALYSIS

SEIX HIGH YIELD

PERIODS ENDING 3/05

	LAST QTR		LAST 2 QTRS		LAST 3 QTRS		LAST YEAR		LAST 3 YEARS		LAST 5 YEARS	
TOTAL FUND	- 1.5	93	1.5	18	6.5	7	5.0	7				
ALLOCATION IDX	- 1.2	91	2.5	7	7.4	4	6.4	4				
MEDIAN	- 0.3		0.9		3.9		1.8		6.4		7.3	
BONDS	- 1.5	92	1.5	18	6.5	7	5.0	7				
LB AGGREGATE	- 0.5	60	0.5	65	3.7	58	1.2	66	6.0	63	7.1	60
ML HIGH YLD II	- 1.4	92	3.0	4	7.8	4	6.9	3	10.5	2	6.7	72
MEDIAN	- 0.4		0.8		4.0		1.7		6.4		7.4	

VERMONT MUNICIPAL EMPLOYEES
PERFORMANCE ANALYSIS
VERMONT INVESTMENTS

PERIODS ENDING 3/05

	LAST QTR		LAST 2 QTRS		LAST 3 QTRS		LAST YEAR		LAST 3 YEARS		LAST 5 YEARS	
TOTAL FUND	1.8	1	2.9	3	3.7	3	3.4	4	2.7	9	3.9	9
ALLOCATION IDX	0.6	18	1.2	13	2.1	7	2.2	9	2.0	15	3.2	21
MEDIAN	0.5		1.0		1.3		1.5		1.4		2.8	
CASH EQUIV.	2.0	1	3.0	1	3.3	2	3.4	2	1.9	10		
MEDIAN	0.5		1.0		1.3		1.5		1.4		2.8	
BONDS	1.1	2	2.4	7	4.7	23	3.0	18	4.8	85		
LB AGGREGATE	-0.5	60	0.5	65	3.7	58	1.2	66	6.0	63	7.1	60
ML HIGH YLD II	-1.4	92	3.0	4	7.8	4	6.9	3	10.5	2	6.7	72
MEDIAN	-0.4		0.8		4.0		1.7		6.4		7.4	

VERMONT MUNICIPAL EMPLOYEES
REAL ESTATE SEGMENT RATES OF RETURN
PERIODS ENDING 3/05

		ASSETS AT MKT \$MM	PCT OF ACCT	LAST QTR	LAST 2 QTRS	LAST 3 QTRS	LAST YEAR	LAST 3 YEARS	LAST 5 YEARS
MUNICIPAL SYSTEM COMPOSITE	INCOME			0.0	0.0	0.0	0.0	3.6	2.2
	APPRECIATION			4.1	6.6	6.8	9.9	3.0	4.7
	TOTAL	17.0	7.1	4.1	6.6	6.8	9.9	6.6	6.9
MET LIFE / SSR TOWER FUND	INCOME			0.0	0.0	0.0	0.0	3.6	2.2
	APPRECIATION			4.1	6.6	6.8	9.9	3.0	4.7
	TOTAL	17.0	100.0	4.1	6.6	6.8	9.9	6.6	6.9

VERMONT MUNICIPAL EMPLOYEES

PERFORMANCE HISTORY

MUNICIPAL SYSTEM COMPOSITE

QUARTER ENDING	TOTAL FUND	ALLOC INDEX	EQUITY SEGMENT	S&P 500 INDEX	BOND SEGMENT	LEHMN AGG INDX	CASH SEGMENT	91-DAY T-BILL
06/ 95	7. 3	6. 0						
09/ 95	5. 8	5. 1						
12/ 95	4. 5	4. 6						
03/ 96	2. 4	2. 9						
ANNUAL	21. 6	20. 0						
06/ 96	3. 6	2. 5	3. 2	4. 5	0. 4	0. 6		
09/ 96	2. 8	1. 9	3. 6	3. 1	2. 1	1. 8		
12/ 96	6. 3	4. 9	9. 6	8. 3	3. 5	3. 0		
03/ 97	0. 3	0. 4	0. 8	2. 7	- 0. 1	- 0. 6		
ANNUAL	13. 5	10. 0	18. 1	19. 8	6. 0	4. 9		
06/ 97	10. 4	11. 6	17. 7	17. 5	3. 7	3. 7		
09/ 97	7. 0	5. 1	11. 3	7. 5	3. 4	3. 3		
12/ 97	0. 6	0. 3	0. 6	2. 9	2. 0	2. 9		
03/ 98	10. 1	10. 5	16. 5	13. 9	- 1. 5	1. 5		
ANNUAL	30. 7	30. 0	53. 3	48. 0	7. 8	12. 0		
06/ 98	2. 2	2. 4	- 3. 2	3. 3	1. 8	2. 3		
09/ 98	- 4. 2	- 5. 9	- 12. 2	- 9. 9	5. 4	4. 2		
12/ 98	13. 2	14. 0	22. 0	21. 3	2. 6	0. 3		
03/ 99	2. 7	2. 4	6. 1	5. 0	- 1. 5	- 0. 5		
ANNUAL	13. 8	12. 4	17. 3	18. 5	8. 4	6. 5		
06/ 99	2. 6	3. 3	5. 5	7. 0	- 1. 3	- 0. 9		
09/ 99	- 2. 7	- 1. 7	- 7. 7	- 6. 2	0. 6	0. 7		
12/ 99	6. 9	10. 7	10. 9	14. 9	- 0. 5	- 0. 1		
03/ 00	1. 4	5. 0	1. 9	2. 3	2. 4	2. 2		
ANNUAL	8. 2	18. 0	10. 1	18. 0	1. 1	1. 9		

VERMONT MUNICIPAL EMPLOYEES

PERFORMANCE HISTORY

MUNICIPAL SYSTEM COMPOSITE

<u>QUARTER ENDING</u>	<u>INT'L C/S</u>	<u>INT'L BOND</u>	<u>CONV</u>	<u>MORT</u>	<u>REAL ESTATE</u>	<u>SV ASSETS</u>	<u>PRVT INVEST</u>	<u>MISC</u>
06/95								7.3
09/95								5.8
12/95								4.5
03/96								2.4
ANNUAL								21.6
06/96					1.1		3.1	
09/96					2.2		-1.3	
12/96					2.2		0.0	
03/97					2.0		1.3	
ANNUAL					7.6		3.1	
06/97					2.2		-2.0	
09/97					3.1		1.6	
12/97					3.0		-1.0	
03/98					3.6		0.0	
ANNUAL					12.4		-1.3	
06/98					3.1		0.0	
09/98					3.4		0.0	
12/98					3.2		0.0	
03/99					2.3		0.0	
ANNUAL					12.6		0.1	
06/99					3.2		11.2	
09/99					2.5		0.0	
12/99					2.9		0.0	
03/00					2.8		0.0	
ANNUAL					11.9		11.2	

VERMONT MUNICIPAL EMPLOYEES

PERFORMANCE HISTORY

MUNICIPAL SYSTEM COMPOSITE

QUARTER ENDING	TOTAL FUND	ALLOC INDEX	EQUITY SEGMENT	S&P 500 INDEX	BOND SEGMENT	LEHMN AGG INDX	CASH SEGMENT	91-DAY T-BILL
06/ 00	0.4	-1.3	-1.6	-2.7	1.8	1.7		
09/ 00	0.5	0.3	1.0	-1.0	3.3	3.0		
12/ 00	1.2	-3.2	-2.1	-7.8	4.5	4.2		
03/ 01	-4.4	-6.3	-9.1	-11.9	3.0	3.0		
ANNUAL	-2.4	-10.1	-11.5	-21.7	13.2	12.5		
06/ 01	3.5	3.5	6.7	5.9	0.7	0.6	1.1	1.1
09/ 01	-5.7	-8.8	-12.6	-14.7	4.6	4.6	0.9	1.1
12/ 01	6.1	6.6	13.7	10.7	-1.2	0.0	0.5	0.6
03/ 02	1.6	0.4	2.4	0.3	0.1	0.1	0.5	0.4
ANNUAL	5.3	1.1	8.6	0.3	4.1	5.3	3.0	3.3
06/ 02	-3.5	-4.2	-10.5	-13.4	3.1	3.7	0.4	0.5
09/ 02	-9.7	-9.4	-17.8	-17.3	2.7	4.6	0.5	0.5
12/ 02	4.3	4.6	5.2	8.4	2.2	1.6	0.3	0.4
03/ 03	-2.3	-2.2	-3.6	-3.1	1.6	1.4	0.3	0.3
ANNUAL	-11.1	-11.3	-25.4	-24.8	10.0	11.7	1.5	1.7
06/ 03	10.7	11.3	16.1	15.4	3.0	2.5	0.2	0.3
09/ 03	3.3	3.5	4.4	2.6	0.2	-0.1	0.3	0.2
12/ 03	8.1	9.2	11.8	12.2	1.1	0.3	0.2	0.3
03/ 04	2.4	3.0	2.5	1.7	2.6	2.7	0.3	0.2
ANNUAL	26.6	29.6	38.9	35.1	7.0	5.4	0.9	1.1
06/ 04	0.4	0.1	1.9	1.7	-1.9	-2.4	0.1	0.2
09/ 04	0.0	0.3	-3.2	-1.9	3.8	3.2	0.3	0.4
12/ 04	7.1	8.0	9.7	9.2	1.2	1.0	0.9	0.5
03/ 05	-1.4	-1.5	-3.3	-2.1	-0.4	-0.5	1.6	0.6
ANNUAL	6.0	6.8	4.6	6.7	2.6	1.2	3.0	1.7
HISTORICAL CUMULATIVE	172.4	154.0	143.7	111.1	78.2	79.9	8.7	7.9
ANNUAL EQUIVALENT	10.5	9.8	10.4	8.7	6.6	6.7	2.1	1.9

VERMONT MUNICIPAL EMPLOYEES

PERFORMANCE HISTORY

MUNICIPAL SYSTEM COMPOSITE

<u>QUARTER ENDING</u>	<u>INT'L C/S</u>	<u>INT'L BOND</u>	<u>CONV</u>	<u>MORT</u>	<u>REAL ESTATE</u>	<u>SV ASSETS</u>	<u>PRVT INVEST</u>	<u>MISC</u>
06/00					2.3		53.7	
09/00					2.8		0.0	
12/00					4.4		0.0	
03/01					1.8		1.9	
ANNUAL					11.8		56.6	
06/01	2.1				1.8		5.9	
09/01	-11.0				0.6		0.0	
12/01	7.7				0.6		0.0	
03/02	3.3				0.0		0.0	
ANNUAL	1.0				3.1		5.9	
06/02	-0.3				0.9		-22.2	
09/02	-20.3				0.4		0.0	
12/02	8.9				0.6		0.0	
03/03	-8.1				1.8		0.0	
ANNUAL	-20.4				3.7		-22.2	
06/03	18.2				2.1		-7.2	
09/03	6.9				2.4		0.0	
12/03	16.3				0.6		0.0	
03/04	2.8				1.0		0.0	
ANNUAL	51.1				6.3		-7.2	
06/04	-0.2				2.9		0.0	
09/04	1.6				0.2		0.0	
12/04	14.3				2.4		-22.7	
03/05	-0.4				4.1		0.0	
ANNUAL	15.5				9.9		-22.7	
HISTORICAL CUMULATIVE	40.3				112.6		4.8	
ANNUAL EQUIVALENT	8.8				8.7		0.5	

VERMONT MUNICIPAL EMPLOYEES

PERFORMANCE HISTORY

MUNI POLICY INDEX

QUARTER ENDING	TOTAL FUND	ALLOC INDEX	EQUITY SEGMENT	S&P 500 INDEX	BOND SEGMENT	LEHMN AGG INDX	CASH SEGMENT	91-DAY T-BILL
06/95	6.5							
09/95	4.3							
12/95	4.5							
03/96	2.0							
ANNUAL	18.5							
06/96	2.7							
09/96	2.6							
12/96	5.4							
03/97	1.0							
ANNUAL	12.2							
06/97	10.6							
09/97	5.0							
12/97	2.1							
03/98	8.4							
ANNUAL	28.5							
06/98	2.9							
09/98	-4.2							
12/98	12.3							
03/99	2.5							
ANNUAL	13.4							
06/99	3.4							
09/99	-1.6							
12/99	8.9							
03/00	2.1							
ANNUAL	13.2							

VERMONT MUNICIPAL EMPLOYEES

PERFORMANCE HISTORY

MUNI POLICY INDEX

QUARTER ENDING	TOTAL FUND	ALLOC INDEX	EQUITY SEGMENT	S&P 500 INDEX	BOND SEGMENT	LEHMN AGG INDX	CASH SEGMENT	91-DAY T-BILL
06/00	- 0.8							
09/00	- 0.2							
12/00	- 2.1							
03/01	- 6.2							
ANNUAL	- 9.1							
06/01	3.7							
09/01	- 8.3							
12/01	7.0							
03/02	1.0							
ANNUAL	2.7							
06/02	- 4.4							
09/02	- 10.2							
12/02	5.2							
03/03	- 2.0							
ANNUAL	- 11.4							
06/03	11.4							
09/03	3.5							
12/03	8.8							
03/04	3.0							
ANNUAL	29.3							
06/04	0.1							
09/04	0.5							
12/04	7.6							
03/05	- 1.3							
ANNUAL	6.8							
HISTORICAL CUMULATIVE	150.3							
ANNUAL EQUIVALENT	9.6							

VERMONT MUNICIPAL EMPLOYEES

PERFORMANCE HISTORY

DOMESTIC EQUITY COMPOSITE

QUARTER ENDING	TOTAL FUND	ALLOC INDEX	EQUITY SEGMENT	S&P 500 INDEX	BOND SEGMENT	LEHMN AGG INDX	CASH SEGMENT	91-DAY T-BILL
06/ 95								
09/ 95								
12/ 95								
03/ 96								
ANNUAL								
06/ 96	3. 2	4. 0	3. 2	4. 5				
09/ 96	3. 6	3. 1	3. 6	3. 1				
12/ 96	9. 6	7. 9	9. 6	8. 3				
03/ 97	0. 8	1. 2	0. 8	2. 7				
ANNUAL	18. 1	17. 1	18. 1	19. 8				
06/ 97	17. 7	16. 5	17. 7	17. 5				
09/ 97	11. 3	8. 4	11. 3	7. 5				
12/ 97	0. 6	1. 9	0. 6	2. 9				
03/ 98	16. 5	13. 2	16. 5	13. 9				
ANNUAL	53. 3	45. 6	53. 3	48. 0				
06/ 98	- 3. 2	- 2. 7	- 3. 2	- 3. 3				
09/ 98	- 12. 2	- 11. 0	- 12. 2	- 9. 9				
12/ 98	22. 0	22. 4	22. 0	21. 3				
03/ 99	6. 1	4. 7	6. 1	5. 0				
ANNUAL	17. 3	17. 2	17. 3	18. 5				
06/ 99	5. 5	6. 9	5. 5	7. 0				
09/ 99	- 7. 7	- 6. 3	- 7. 7	- 6. 2				
12/ 99	10. 9	18. 0	10. 9	14. 9				
03/ 00	1. 9	5. 3	1. 9	2. 3				
ANNUAL	10. 1	24. 6	10. 1	18. 0				

VERMONT MUNICIPAL EMPLOYEES

PERFORMANCE HISTORY

DOMESTIC EQUITY COMPOSITE

QUARTER ENDING	TOTAL FUND	ALLOC INDEX	EQUITY SEGMENT	S&P 500 INDEX	BOND SEGMENT	LEHMN AGG INDX	CASH SEGMENT	91-DAY T-BILL
06/ 00	- 1. 6	- 3. 2	- 1. 6	- 2. 7				
09/ 00	1. 0	0. 7	1. 0	- 1. 0				
12/ 00	- 2. 1	- 9. 8	- 2. 1	- 7. 8				
03/ 01	- 9. 1	- 11. 7	- 9. 1	- 11. 9				
ANNUAL	- 11. 5	- 22. 4	- 11. 5	- 21. 7				
06/ 01	6. 7	8. 0	6. 7	5. 9				
09/ 01	- 12. 6	- 18. 4	- 12. 6	- 14. 7			0. 7	1. 1
12/ 01	13. 7	13. 5	13. 7	10. 7			0. 7	0. 6
03/ 02	2. 4	0. 7	2. 4	0. 3			0. 4	0. 4
ANNUAL	8. 7	0. 7	8. 6	0. 3				
06/ 02	- 10. 4	- 12. 5	- 10. 5	- 13. 4			0. 5	0. 5
09/ 02	- 17. 6	- 18. 4	- 17. 8	- 17. 3			0. 5	0. 5
12/ 02	4. 9	6. 7	5. 2	8. 4			0. 4	0. 4
03/ 03	- 3. 6	- 3. 3	- 3. 6	- 3. 1				
ANNUAL	- 25. 3	- 26. 3	- 25. 4	- 24. 8				
06/ 03	16. 1	17. 5	16. 1	15. 4				
09/ 03	4. 4	4. 4	4. 4	2. 6				
12/ 03	11. 8	12. 9	11. 8	12. 2				
03/ 04	2. 5	3. 0	2. 5	1. 7				
ANNUAL	38. 9	42. 6	38. 9	35. 1				
06/ 04	1. 9	1. 2	1. 9	1. 7				
09/ 04	- 3. 2	- 2. 0	- 3. 2	- 1. 9				
12/ 04	9. 7	10. 8	9. 7	9. 2				
03/ 05	- 3. 3	- 2. 8	- 3. 3	- 2. 1				
ANNUAL	4. 6	6. 9	4. 6	6. 7				
HISTORICAL CUMULATIVE	144. 0	118. 6	143. 7	111. 1				
ANNUAL EQUIVALENT	10. 4	9. 1	10. 4	8. 7				

VERMONT MUNICIPAL EMPLOYEES

PERFORMANCE HISTORY

DELAWARE

QUARTER ENDING	TOTAL FUND	ALLOC INDEX	EQUITY SEGMENT	S&P 500 INDEX	BOND SEGMENT	LEHMN AGG INDX	CASH SEGMENT	91-DAY T-BILL
06/ 95	6. 8	8. 7	6. 8	9. 5				
09/ 95	8. 3	8. 0	8. 3	7. 9				
12/ 95	6. 7	6. 5	6. 7	6. 0				
03/ 96	5. 3	6. 4	5. 3	5. 4				
ANNUAL	30. 0	32. 9	30. 0	32. 0				
06/ 96	2. 7	2. 0	2. 7	4. 5				
09/ 96	4. 0	2. 6	4. 0	3. 1				
12/ 96	8. 4	9. 5	8. 4	8. 3				
03/ 97	2. 4	1. 8	2. 4	2. 7				
ANNUAL	18. 7	16. 7	18. 7	19. 8				
06/ 97	15. 7	14. 5	15. 7	17. 5				
09/ 97	9. 0	9. 2	9. 0	7. 5				
12/ 97	2. 5	2. 2	2. 5	2. 9				
03/ 98	11. 5	11. 6	11. 5	13. 9				
ANNUAL	44. 1	42. 5	44. 1	48. 0				
06/ 98	- 0. 8	0. 5	- 0. 8	3. 3				
09/ 98	- 12. 0	- 12. 9	- 12. 0	- 9. 9				
12/ 98	14. 0	17. 4	14. 0	21. 3				
03/ 99	- 0. 3	2. 9	- 0. 3	5. 0				
ANNUAL	- 0. 9	5. 7	- 0. 9	18. 5				
06/ 99	6. 7	10. 8	6. 7	7. 0				
09/ 99	- 9. 6	- 9. 2	- 9. 6	- 6. 2				
12/ 99	3. 5	9. 0	3. 5	14. 9				
03/ 00	- 5. 3	0. 2	- 5. 3	2. 3				
ANNUAL	- 5. 4	9. 9	- 5. 4	18. 0				

VERMONT MUNICIPAL EMPLOYEES

PERFORMANCE HISTORY

DELAWARE

QUARTER ENDING	TOTAL FUND	ALLOC INDEX	EQUITY SEGMENT	S&P 500 INDEX	BOND SEGMENT	LEHMN AGG INDX	CASH SEGMENT	91-DAY T-BILL
06/ 00	0. 1	- 4. 3	0. 1	- 2. 7				
09/ 00	8. 7	8. 8	8. 7	- 1. 0				
12/ 00	10. 0	1. 6	10. 0	- 7. 8				
03/ 01	- 3. 9	- 6. 5	- 3. 9	- 11. 9				
ANNUAL	14. 9	- 1. 1	14. 9	- 21. 7				
06/ 01	- 3. 9	4. 4	- 3. 9	5. 9				
09/ 01	- 11. 4	- 16. 2	- 11. 4	- 14. 7			0. 7	1. 1
12/ 01	8. 6	8. 0	8. 6	10. 7			0. 7	0. 6
03/ 02	5. 5	1. 3	5. 6	0. 3			0. 4	0. 4
ANNUAL	5. 5	- 4. 3	5. 5	0. 3				
06/ 02	- 7. 5	- 10. 6	- 7. 6	- 13. 4			0. 6	0. 5
09/ 02	- 18. 6	- 20. 3	- 18. 7	- 17. 3			0. 5	0. 5
12/ 02	8. 0	9. 9	8. 0	8. 4			0. 5	0. 4
03/ 03	- 5. 4	- 4. 9	- 5. 4	- 3. 1				
ANNUAL	- 23. 1	- 25. 5	- 23. 2	- 24. 8				
06/ 03	18. 2	17. 3	18. 2	15. 4				
09/ 03	2. 6	2. 1	2. 6	2. 6				
12/ 03	12. 9	14. 2	12. 9	12. 2				
03/ 04	1. 8	3. 0	1. 8	1. 7				
ANNUAL	39. 3	40. 8	39. 3	35. 1				
06/ 04	1. 9	0. 9	1. 9	1. 7				
09/ 04	- 1. 2	1. 5	- 1. 2	- 1. 9				
12/ 04	8. 7	10. 4	8. 8	9. 2				
03/ 05	- 1. 3	0. 1	- 1. 3	- 2. 1				
ANNUAL	8. 1	13. 2	8. 2	6. 7				
HISTORICAL CUMULATIVE	192. 5	188. 5	192. 4	178. 7				
ANNUAL EQUIVALENT	11. 3	11. 2	11. 3	10. 8				

VERMONT MUNICIPAL EMPLOYEES

PERFORMANCE HISTORY

ALLIANCE LARGE CAP GROWTH FUND

QUARTER ENDING	TOTAL FUND	ALLOC INDEX	EQUITY SEGMENT	S&P 500 INDEX	BOND SEGMENT	LEHMN AGG INDX	CASH SEGMENT	91-DAY T-BILL
06/ 95	15. 7	9. 8	15. 7	9. 5				
09/ 95	11. 8	9. 1	11. 8	7. 9				
12/ 95	- 0. 5	4. 6	- 0. 5	6. 0				
03/ 96	7. 4	5. 4	7. 4	5. 4				
ANNUAL	38. 3	32. 0	38. 3	32. 0				
06/ 96	3. 8	6. 4	3. 8	4. 5				
09/ 96	3. 2	3. 6	3. 2	3. 1				
12/ 96	11. 0	6. 0	11. 0	8. 3				
03/ 97	- 1. 2	0. 5	- 1. 2	2. 7				
ANNUAL	17. 5	17. 5	17. 5	19. 8				
06/ 97	20. 1	18. 9	20. 1	17. 5				
09/ 97	13. 3	7. 5	13. 3	7. 5				
12/ 97	- 1. 8	1. 5	- 1. 8	2. 9				
03/ 98	21. 6	15. 2	21. 6	13. 9				
ANNUAL	62. 5	49. 5	62. 5	48. 0				
06/ 98	- 8. 3	4. 5	- 8. 3	3. 3				
09/ 98	- 12. 5	- 9. 1	- 12. 5	- 9. 9				
12/ 98	32. 0	26. 7	32. 0	21. 3				
03/ 99	10. 8	6. 4	10. 8	5. 0				
ANNUAL	38. 6	28. 1	38. 6	18. 5				
06/ 99	3. 8	3. 8	3. 8	7. 0				
09/ 99	- 5. 2	- 3. 7	- 5. 2	- 6. 2				
12/ 99	21. 7	25. 1	21. 7	14. 9				
03/ 00	6. 6	7. 1	6. 6	2. 3				
ANNUAL	27. 5	34. 1	27. 5	18. 0				

VERMONT MUNICIPAL EMPLOYEES

PERFORMANCE HISTORY

ALLIANCE LARGE CAP GROWTH FUND

QUARTER ENDING	TOTAL FUND	ALLOC INDEX	EQUITY SEGMENT	S&P 500 INDEX	BOND SEGMENT	LEHMN AGG INDX	CASH SEGMENT	91-DAY T-BILL
06/ 00	- 3. 3	- 2. 7	- 3. 3	- 2. 7				
09/ 00	- 5. 8	- 5. 4	- 5. 8	- 1. 0				
12/ 00	- 14. 9	- 21. 3	- 14. 9	- 7. 8				
03/ 01	- 17. 4	- 20. 9	- 17. 4	- 11. 9				
ANNUAL	- 36. 0	- 42. 7	- 36. 0	- 21. 7				
06/ 01	6. 3	8. 4	6. 3	5. 9				
09/ 01	- 15. 5	- 19. 4	- 15. 5	- 14. 7			1. 0	1. 1
12/ 01	15. 2	15. 1	15. 2	10. 7			0. 7	0. 6
03/ 02	- 4. 6	- 2. 6	- 4. 6	0. 3			0. 5	0. 4
ANNUAL	- 1. 3	- 2. 0	- 1. 4	0. 3				
06/ 02	- 14. 9	- 17. 9	- 15. 5	- 13. 4			0. 5	0. 5
09/ 02	- 15. 0	- 13. 6	- 15. 0	- 17. 3			0. 5	0. 5
12/ 02	1. 8	4. 2	2. 5	8. 4				
03/ 03	- 1. 1	- 1. 1	- 1. 1	- 3. 1				
ANNUAL	- 27. 1	- 26. 9	- 27. 1	- 24. 8				
06/ 03	12. 7	14. 3	12. 7	15. 4				
09/ 03	3. 9	3. 9	3. 9	2. 6				
12/ 03	8. 8	10. 4	8. 8	12. 2				
03/ 04	1. 6	0. 8	1. 6	1. 7				
ANNUAL	29. 4	32. 2	29. 4	35. 1				
06/ 04	1. 8	1. 9	1. 8	1. 7				
09/ 04	- 5. 7	- 5. 2	- 5. 7	- 1. 9				
12/ 04	9. 2	9. 2	9. 2	9. 2				
03/ 05	- 6. 2	- 4. 1	- 6. 2	- 2. 1				
ANNUAL	- 1. 7	1. 2	- 1. 7	6. 7				
HISTORICAL CUMULATIVE	173. 6	118. 4	173. 6	178. 7				
ANNUAL EQUIVALENT	10. 6	8. 1	10. 6	10. 8				

VERMONT MUNICIPAL EMPLOYEES

PERFORMANCE HISTORY

LAZARD SMALL CAP FUND

QUARTER ENDING	TOTAL FUND	ALLOC INDEX	EQUITY SEGMENT	S&P 500 INDEX	BOND SEGMENT	LEHMN AGG INDX	CASH SEGMENT	91-DAY T-BILL
06/95								
09/95								
12/95								
03/96								
ANNUAL								
06/96								
09/96								
12/96								
03/97								
ANNUAL								
06/97								
09/97								
12/97								
03/98								
ANNUAL								
06/98								
09/98								
12/98								
03/99								
ANNUAL								
06/99								
09/99	- 9.2	- 6.3	- 9.2	- 6.2				
12/99	1.0	18.4	1.0	14.9				
03/00	3.9	7.1	3.9	2.3				
ANNUAL								

VERMONT MUNICIPAL EMPLOYEES

PERFORMANCE HISTORY

LAZARD SMALL CAP FUND

QUARTER ENDING	TOTAL FUND	ALLOC INDEX	EQUITY SEGMENT	S&P 500 INDEX	BOND SEGMENT	LEHMN AGG INDX	CASH SEGMENT	91-DAY T-BILL
06/ 00	0. 2	- 3. 8	0. 2	- 2. 7				
09/ 00	5. 0	1. 1	5. 0	- 1. 0				
12/ 00	6. 0	- 6. 9	6. 0	- 7. 8				
03/ 01	- 2. 9	- 6. 5	- 2. 9	- 11. 9				
ANNUAL	8. 3	- 15. 3	8. 3	- 21. 7				
06/ 01	13. 1	14. 3	13. 1	5. 9				
09/ 01	- 10. 1	- 20. 8	- 10. 3	- 14. 7				
12/ 01	20. 6	21. 1	20. 6	10. 7				
03/ 02	7. 2	4. 0	7. 2	0. 3				
ANNUAL	31. 3	14. 0	31. 1	0. 3				
06/ 02	- 9. 1	- 8. 4	- 9. 1	- 13. 4				
09/ 02	- 19. 3	- 21. 4	- 19. 3	- 17. 3				
12/ 02	5. 1	6. 2	5. 1	8. 4				
03/ 03	- 4. 9	- 4. 5	- 4. 9	- 3. 1				
ANNUAL	- 26. 6	- 27. 0	- 26. 6	- 24. 8				
06/ 03	18. 4	23. 4	18. 4	15. 4				
09/ 03	8. 3	9. 1	8. 3	2. 6				
12/ 03	14. 7	14. 5	14. 7	12. 2				
03/ 04	4. 9	6. 3	4. 9	1. 7				
ANNUAL	54. 3	63. 8	54. 3	35. 1				
06/ 04	1. 7	0. 5	1. 7	1. 7				
09/ 04	- 2. 7	- 2. 9	- 2. 7	- 1. 9				
12/ 04	11. 9	14. 1	11. 9	9. 2				
03/ 05	- 1. 8	- 5. 3	- 1. 8	- 2. 1				
ANNUAL	8. 7	5. 4	8. 7	6. 7				
HISTORICAL CUMULATIVE	66. 8	44. 6	66. 5	- 6. 1				
ANNUAL EQUIVALENT	9. 3	6. 6	9. 3	- 1. 1				

VERMONT MUNICIPAL EMPLOYEES

PERFORMANCE HISTORY

BRINSON - UBS

QUARTER ENDING	TOTAL FUND	ALLOC INDEX	EQUITY SEGMENT	S&P 500 INDEX	BOND SEGMENT	LEHMN AGG INDX	CASH SEGMENT	91-DAY T-BILL
06/ 95	5. 9	0. 7						
09/ 95	6. 1	4. 2						
12/ 95	5. 8	4. 0						
03/ 96	1. 4	2. 9						
ANNUAL	20. 6	12. 3						
06/ 96	2. 6	1. 6						
09/ 96	2. 7	- 0. 1						
12/ 96	4. 4	1. 6						
03/ 97	- 1. 4	- 1. 6						
ANNUAL	8. 4	1. 5						
06/ 97	7. 1	13. 0						
09/ 97	2. 4	- 0. 7						
12/ 97	- 1. 5	- 7. 8						
03/ 98	5. 4	14. 7						
ANNUAL	13. 8	18. 6						
06/ 98	0. 9	1. 1						
09/ 98	- 0. 2	- 14. 2						
12/ 98	18. 0	20. 7						
03/ 99	- 0. 1	1. 4						
ANNUAL	18. 7	6. 1						
06/ 99	3. 6	2. 5						
09/ 99	2. 6	4. 4						
12/ 99	14. 8	17. 0						
03/ 00	- 3. 4	- 0. 1						
ANNUAL	17. 7	25. 1						

VERMONT MUNICIPAL EMPLOYEES

PERFORMANCE HISTORY

BRINSON - UBS

<u>QUARTER ENDING</u>	<u>INT'L C/S</u>	<u>INT'L BOND</u>	<u>CONV</u>	<u>MORT</u>	<u>REAL ESTATE</u>	<u>SV ASSETS</u>	<u>PRVT INVEST</u>	<u>MISC</u>
06/95	5.9							
09/95	6.1							
12/95	5.8							
03/96	1.4							
ANNUAL	20.6							
06/96	2.6							
09/96	2.7							
12/96	4.4							
03/97	-1.4							
ANNUAL	8.4							
06/97	7.1							
09/97	2.4							
12/97	-1.5							
03/98	5.4							
ANNUAL	13.8							
06/98	0.9							
09/98	-0.2							
12/98	18.0							
03/99	-0.1							
ANNUAL	18.7							
06/99	3.6							
09/99	2.6							
12/99	14.8							
03/00	-3.4							
ANNUAL	17.7							

VERMONT MUNICIPAL EMPLOYEES

PERFORMANCE HISTORY

BRINSON - UBS

QUARTER ENDING	TOTAL FUND	ALLOC INDEX	EQUITY SEGMENT	S&P 500 INDEX	BOND SEGMENT	LEHMN AGG INDX	CASH SEGMENT	91-DAY T-BILL
06/00	0.7	-4.0						
09/00	-7.3	-8.1						
12/00	1.9	-2.7						
03/01	-11.7	-13.6						
ANNUAL	-16.0	-25.8						
06/01	2.1	-1.0						
09/01	-11.0	-14.0						
12/01	7.7	7.0					0.7	0.6
03/02	3.3	0.5					0.4	0.4
ANNUAL	1.0	-8.5						
06/02	-0.3	-2.1					0.6	0.5
09/02	-20.3	-19.7					0.5	0.5
12/02	8.9	6.5					0.4	0.4
03/03	-8.1	-8.2					0.4	0.3
ANNUAL	-20.4	-23.2					1.8	1.7
06/03	18.2	19.3					0.5	0.3
09/03	6.9	8.1					0.3	0.2
12/03	16.3	17.1					0.3	0.3
03/04	2.8	4.3					0.3	0.2
ANNUAL	51.1	57.5					1.4	1.1
06/04	-0.2	0.2					0.3	0.2
09/04	1.6	-0.3					0.3	0.4
12/04	14.3	15.3					0.4	0.5
03/05	-0.4	-0.2					0.4	0.6
ANNUAL	15.5	15.1					1.5	1.7
HISTORICAL CUMULATIVE	145.5	69.5					5.9	5.6
ANNUAL EQUIVALENT	9.4	5.4					1.7	1.6

VERMONT MUNICIPAL EMPLOYEES

PERFORMANCE HISTORY

BRINSON - UBS

<u>QUARTER ENDING</u>	<u>INT'L C/S</u>	<u>INT'L BOND</u>	<u>CONV</u>	<u>MORT</u>	<u>REAL ESTATE</u>	<u>SV ASSETS</u>	<u>PRVT INVEST</u>	<u>MISC</u>
06/00	0.7							
09/00	-7.3							
12/00	1.9							
03/01	-11.7							
ANNUAL	-16.0							
06/01	2.1							
09/01	-11.0							
12/01	7.7							
03/02	3.3							
ANNUAL	1.0							
06/02	-0.3							
09/02	-20.3							
12/02	8.9							
03/03	-8.1							
ANNUAL	-20.4							
06/03	18.2							
09/03	6.9							
12/03	16.3							
03/04	2.8							
ANNUAL	51.1							
06/04	-0.2							
09/04	1.6							
12/04	14.3							
03/05	-0.4							
ANNUAL	15.5							
HISTORICAL CUMULATIVE	145.4							
ANNUAL EQUIVALENT	9.4							

VERMONT MUNICIPAL EMPLOYEES

PERFORMANCE HISTORY

MET LIFE / SSR TOWER FUND

QUARTER ENDING	TOTAL FUND	ALLOC INDEX	EQUITY SEGMENT	S&P 500 INDEX	BOND SEGMENT	LEHMN AGG INDX	CASH SEGMENT	91-DAY T-BILL
06/ 95	0. 0	2. 5						
09/ 95	0. 0	2. 2						
12/ 95	5. 9	1. 8						
03/ 96	- 3. 7	2. 6						
ANNUAL	2. 0	9. 5						
06/ 96	1. 1	2. 6						
09/ 96	2. 2	3. 0						
12/ 96	2. 2	2. 5						
03/ 97	2. 0	2. 5						
ANNUAL	7. 6	11. 0						
06/ 97	2. 2	3. 1						
09/ 97	3. 1	3. 7						
12/ 97	3. 0	4. 7						
03/ 98	3. 6	4. 1						
ANNUAL	12. 4	16. 6						
06/ 98	3. 1	4. 6						
09/ 98	3. 4	3. 9						
12/ 98	3. 2	3. 7						
03/ 99	2. 3	2. 7						
ANNUAL	12. 6	15. 6						
06/ 99	3. 2	2. 8						
09/ 99	2. 5	3. 1						
12/ 99	2. 9	2. 8						
03/ 00	2. 8	2. 6						
ANNUAL	11. 9	11. 8						

VERMONT MUNICIPAL EMPLOYEES

PERFORMANCE HISTORY

MET LIFE / SSR TOWER FUND

<u>QUARTER ENDING</u>	<u>INT'L C/S</u>	<u>INT'L BOND</u>	<u>CONV</u>	<u>MORT</u>	<u>REAL ESTATE</u>	<u>SV ASSETS</u>	<u>PRVT INVEST</u>	<u>MISC</u>
06/95					0.0			
09/95					0.0			
12/95					5.9			
03/96					-3.7			
ANNUAL					2.0			
06/96					1.1			
09/96					2.2			
12/96					2.2			
03/97					2.0			
ANNUAL					7.6			
06/97					2.2			
09/97					3.1			
12/97					3.0			
03/98					3.6			
ANNUAL					12.4			
06/98					3.1			
09/98					3.4			
12/98					3.2			
03/99					2.3			
ANNUAL					12.6			
06/99					3.2			
09/99					2.5			
12/99					2.9			
03/00					2.8			
ANNUAL					11.9			

VERMONT MUNICIPAL EMPLOYEES

PERFORMANCE HISTORY

MET LIFE / SSR TOWER FUND

QUARTER ENDING	TOTAL FUND	ALLOC INDEX	EQUITY SEGMENT	S&P 500 INDEX	BOND SEGMENT	LEHMN AGG INDX	CASH SEGMENT	91-DAY T-BILL
06/00	2.3	3.4						
09/00	2.8	3.2						
12/00	4.4	3.1						
03/01	1.8	2.3						
ANNUAL	11.8	12.5						
06/01	1.8	2.3						
09/01	0.6	2.4						
12/01	0.6	1.4						
03/02	0.0	0.7						
ANNUAL	3.1	6.9						
06/02	0.9	1.1						
09/02	0.4	1.0						
12/02	0.6	1.3						
03/03	1.8	1.3						
ANNUAL	3.7	4.8						
06/03	2.1	1.9						
09/03	2.4	2.1						
12/03	0.6	4.0						
03/04	1.0	2.8						
ANNUAL	6.3	11.1						
06/04	2.9	2.6						
09/04	0.2	3.4						
12/04	2.4	3.4						
03/05	4.1	0.0						
ANNUAL	9.9	9.7						
HISTORICAL CUMULATIVE	116.7	181.7						
ANNUAL EQUIVALENT	8.0	10.9						

VERMONT MUNICIPAL EMPLOYEES

PERFORMANCE HISTORY

MET LIFE / SSR TOWER FUND

<u>QUARTER ENDING</u>	<u>INT'L C/S</u>	<u>INT'L BOND</u>	<u>CONV</u>	<u>MORT</u>	<u>REAL ESTATE</u>	<u>SV ASSETS</u>	<u>PRVT INVEST</u>	<u>MISC</u>
06/00					2.3			
09/00					2.8			
12/00					4.4			
03/01					1.8			
ANNUAL					11.8			
06/01					1.8			
09/01					0.6			
12/01					0.6			
03/02					0.0			
ANNUAL					3.1			
06/02					0.9			
09/02					0.4			
12/02					0.6			
03/03					1.8			
ANNUAL					3.7			
06/03					2.1			
09/03					2.4			
12/03					0.6			
03/04					1.0			
ANNUAL					6.3			
06/04					2.9			
09/04					0.2			
12/04					2.4			
03/05					4.1			
ANNUAL					9.9			
HISTORICAL CUMULATIVE					116.7			
ANNUAL EQUIVALENT					8.0			

VERMONT MUNICIPAL EMPLOYEES

PERFORMANCE HISTORY

SEIX CORE

QUARTER ENDING	TOTAL FUND	ALLOC INDEX	EQUITY SEGMENT	S&P 500 INDEX	BOND SEGMENT	LEHMN AGG INDX	CASH SEGMENT	91-DAY T-BILL
06/00	1.8	1.7			1.8	1.7		
09/00	3.3	3.0			3.3	3.0		
12/00	4.5	4.2			4.5	4.2		
03/01	3.0	3.0			3.0	3.0		
ANNUAL	13.2	12.5			13.2	12.5		
06/01	0.6	0.5			0.6	0.6	1.2	1.1
09/01	4.6	4.6			4.6	4.6		
12/01	-1.2	0.0			-1.2	0.0		
03/02	0.1	0.1			0.1	0.1	0.4	0.4
ANNUAL	4.1	5.3			4.1	5.3		
06/02	3.0	3.7			3.1	3.7		
09/02	2.7	4.6			2.7	4.6		
12/02	2.2	1.6			2.2	1.6		
03/03	1.7	1.4			1.7	1.4		
ANNUAL	9.8	11.7			10.0	11.7		
06/03	2.9	2.5			2.9	2.5		
09/03	0.0	-0.1			0.0	-0.1		
12/03	0.5	0.3			0.5	0.3		
03/04	2.6	2.7			2.6	2.7		
ANNUAL	6.1	5.4			6.1	5.4		
06/04	-2.0	-2.4			-2.0	-2.4		
09/04	3.5	3.2			3.5	3.2		
12/04	0.9	1.0			0.9	1.0		
03/05	-0.3	-0.5			-0.3	-0.5		
ANNUAL	2.1	1.2			2.1	1.2		
HISTORICAL CUMULATIVE	40.2	41.2			40.4	41.2		
ANNUAL EQUIVALENT	7.0	7.1			7.0	7.1		

VERMONT MUNICIPAL EMPLOYEES

PERFORMANCE HISTORY

SEIX HIGH YIELD

QUARTER ENDING	TOTAL FUND	ALLOC INDEX	EQUITY SEGMENT	S&P 500 INDEX	BOND SEGMENT	LEHMN AGG INDX	CASH SEGMENT	91-DAY T-BILL
06/00								
09/00								
12/00								
03/01								
ANNUAL								
06/01								
09/01								
12/01								
03/02								
ANNUAL								
06/02								
09/02								
12/02								
03/03								
ANNUAL								
06/03								
09/03	1.1	1.9			1.1	-0.1		
12/03	4.5	6.0			4.5	0.3		
03/04	2.3	2.0			2.3	2.7		
ANNUAL								
06/04	-1.5	-0.9			-1.5	-2.4		
09/04	5.0	4.8			5.0	3.2		
12/04	3.0	3.8			3.0	1.0		
03/05	-1.5	-1.2			-1.5	-0.5		
ANNUAL	5.0	6.4			5.0	1.2		
HISTORICAL CUMULATIVE	13.4	17.2			13.4	4.0		
ANNUAL EQUIVALENT	7.4	9.5			7.4	2.3		

VERMONT MUNICIPAL EMPLOYEES

PERFORMANCE HISTORY

ALTERNATIVE INVESTMENTS

QUARTER ENDING	TOTAL FUND	ALLOC INDEX	EQUITY SEGMENT	S&P 500 INDEX	BOND SEGMENT	LEHMN AGG INDX	CASH SEGMENT	91-DAY T-BILL
06/ 95	0. 0	14. 2						
09/ 95	- 5. 1	11. 8						
12/ 95	0. 0	0. 8						
03/ 96	7. 6	4. 7						
ANNUAL	2. 1	34. 8						
06/ 96	3. 1	7. 6						
09/ 96	- 1. 3	3. 5						
12/ 96	0. 0	5. 2						
03/ 97	1. 3	- 5. 4						
ANNUAL	3. 1	10. 9						
06/ 97	- 2. 0	18. 0						
09/ 97	- 1. 6	16. 9						
12/ 97	- 1. 0	- 6. 8						
03/ 98	0. 0	16. 9						
ANNUAL	- 1. 3	50. 3						
06/ 98	0. 0	3. 2						
09/ 98	0. 0	- 10. 6						
12/ 98	0. 0	29. 5						
03/ 99	0. 0	12. 3						
ANNUAL	0. 1	34. 1						
06/ 99	11. 2	9. 1						
09/ 99	0. 0	2. 2						
12/ 99	0. 0	48. 2						
03/ 00	0. 0	12. 4						
ANNUAL	11. 2	85. 8						

VERMONT MUNICIPAL EMPLOYEES

PERFORMANCE HISTORY

ALTERNATIVE INVESTMENTS

<u>QUARTER ENDING</u>	<u>INT'L C/S</u>	<u>INT'L BOND</u>	<u>CONV</u>	<u>MORT</u>	<u>REAL ESTATE</u>	<u>SV ASSETS</u>	<u>PRVT INVEST</u>	<u>MISC</u>
06/95							0.0	
09/95							-5.1	
12/95							0.0	
03/96							7.6	
ANNUAL							2.1	
06/96							3.1	
09/96							-1.3	
12/96							0.0	
03/97							1.3	
ANNUAL							3.1	
06/97							-2.0	
09/97							1.6	
12/97							-1.0	
03/98							0.0	
ANNUAL							-1.3	
06/98							0.0	
09/98							0.0	
12/98							0.0	
03/99							0.0	
ANNUAL							0.1	
06/99							11.2	
09/99							0.0	
12/99							0.0	
03/00							0.0	
ANNUAL							11.2	

VERMONT MUNICIPAL EMPLOYEES

PERFORMANCE HISTORY

ALTERNATIVE INVESTMENTS

QUARTER ENDING	TOTAL FUND	ALLOC INDEX	EQUITY SEGMENT	S&P 500 INDEX	BOND SEGMENT	LEHMN AGG INDX	CASH SEGMENT	91-DAY T-BILL
06/00	53.7	- 13.3						
09/00	0.0	- 7.4						
12/00	0.0	- 32.7						
03/01	1.9	- 25.1						
ANNUAL	56.6	- 59.5						
06/01	5.7	17.1					1.1	1.1
09/01	0.1	- 28.8					1.0	1.1
12/01	0.0	28.0					0.7	0.6
03/02	0.0	- 5.0					0.5	0.4
ANNUAL	5.9	1.5					3.2	3.3
06/02	- 20.7	- 19.2					0.5	0.5
09/02	0.0	- 18.3					0.3	0.5
12/02	0.0	12.9					0.5	0.4
03/03	0.0	0.4					0.3	0.3
ANNUAL	- 20.6	- 25.1					1.6	1.7
06/03	- 6.6	19.1					0.2	0.3
09/03	0.0	9.2					0.3	0.2
12/03	0.0	11.0					0.2	0.3
03/04	0.0	- 0.4					0.4	0.2
ANNUAL	- 6.5	43.7					1.1	1.1
06/04	0.0	2.5					0.2	0.2
09/04	0.0	- 6.6					0.3	0.4
12/04	- 18.7	13.0					0.3	0.5
03/05	0.1	- 6.3					0.5	0.6
ANNUAL	- 18.6	1.3					1.4	1.7
HISTORICAL CUMULATIVE	15.9	150.7					7.6	7.9
ANNUAL EQUIVALENT	1.5	9.6					1.8	1.9

VERMONT MUNICIPAL EMPLOYEES

PERFORMANCE HISTORY

ALTERNATIVE INVESTMENTS

<u>QUARTER ENDING</u>	<u>INT'L C/S</u>	<u>INT'L BOND</u>	<u>CONV</u>	<u>MORT</u>	<u>REAL ESTATE</u>	<u>SV ASSETS</u>	<u>PRVT INVEST</u>	<u>MISC</u>
06/00							53.7	
09/00							0.0	
12/00							0.0	
03/01							1.9	
ANNUAL							56.6	
06/01							5.9	
09/01							0.0	
12/01							0.0	
03/02							0.0	
ANNUAL							5.9	
06/02							-22.2	
09/02							0.0	
12/02							0.0	
03/03							0.0	
ANNUAL							-22.2	
06/03							-7.2	
09/03							0.0	
12/03							0.0	
03/04							0.0	
ANNUAL							-7.2	
06/04							0.0	
09/04							0.0	
12/04							-22.7	
03/05							0.0	
ANNUAL							-22.7	
HISTORICAL CUMULATIVE							7.0	
ANNUAL EQUIVALENT							0.7	

VERMONT MUNICIPAL EMPLOYEES

PERFORMANCE HISTORY

VERMONT INVESTMENTS

QUARTER ENDING	TOTAL FUND	ALLOC INDEX	EQUITY SEGMENT	S&P 500 INDEX	BOND SEGMENT	LEHMN AGG INDX	CASH SEGMENT	91-DAY T-BILL
06/ 95	0. 5	1. 5						
09/ 95	1. 7	1. 4						
12/ 95	2. 0	1. 5						
03/ 96	0. 0	1. 2						
ANNUAL	4. 3	5. 7						
06/ 96	0. 9	1. 3						
09/ 96	1. 2	1. 4						
12/ 96	1. 6	1. 3						
03/ 97	0. 6	1. 3						
ANNUAL	4. 4	5. 4						
06/ 97	1. 0	1. 4						
09/ 97	2. 0	1. 3						
12/ 97	0. 5	1. 3						
03/ 98	2. 0	1. 3						
ANNUAL	5. 7	5. 4						
06/ 98	1. 0	1. 3						
09/ 98	1. 9	1. 4						
12/ 98	1. 7	1. 1						
03/ 99	1. 0	1. 1						
ANNUAL	5. 7	5. 0						
06/ 99	-0. 4	1. 2						
09/ 99	1. 2	1. 3						
12/ 99	1. 1	1. 2						
03/ 00	1. 3	1. 4						
ANNUAL	3. 2	5. 2						

VERMONT MUNICIPAL EMPLOYEES

PERFORMANCE HISTORY

VERMONT INVESTMENTS

QUARTER ENDING	TOTAL FUND	ALLOC INDEX	EQUITY SEGMENT	S&P 500 INDEX	BOND SEGMENT	LEHMN AGG INDX	CASH SEGMENT	91-DAY T-BILL
06/ 00	1. 4	1. 5						
09/ 00	1. 9	1. 5						
12/ 00	2. 1	1. 6						
03/ 01	2. 6	2. 0						
ANNUAL	8. 3	6. 9						
06/ 01	1. 1	0. 3			1. 5	0. 6	1. 1	1. 1
09/ 01	1. 3	1. 7			4. 6	4. 6	0. 7	1. 1
12/ 01	0. 4	0. 5			- 0. 4	0. 0	0. 5	0. 6
03/ 02	0. 6	0. 4			2. 0	0. 1	0. 3	0. 4
ANNUAL	3. 4	3. 0			7. 8	5. 3	2. 6	3. 3
06/ 02	0. 9	0. 9			4. 0	3. 7	0. 5	0. 5
09/ 02	1. 8	1. 3			6. 9	4. 6	0. 5	0. 5
12/ 02	0. 1	0. 5			- 0. 4	1. 6	0. 3	0. 4
03/ 03	- 0. 8	0. 6			- 6. 4	1. 4	0. 3	0. 3
ANNUAL	1. 9	3. 4			3. 7	11. 7	1. 5	1. 7
06/ 03	0. 6	0. 3			1. 1	2. 5	0. 2	0. 3
09/ 03	1. 3	- 0. 1			2. 1	- 0. 1	0. 2	0. 2
12/ 03	0. 5	0. 0			3. 0	0. 3	0. 2	0. 3
03/ 04	0. 4	0. 4			1. 5	2. 7	0. 3	0. 2
ANNUAL	2. 7	0. 6			7. 8	5. 4	0. 9	1. 1
06/ 04	- 0. 3	0. 1			- 1. 7	- 2. 4	0. 1	0. 2
09/ 04	0. 8	0. 9			2. 2	3. 2	0. 3	0. 4
12/ 04	1. 1	0. 6			1. 3	1. 0	1. 0	0. 5
03/ 05	1. 8	0. 6			1. 1	- 0. 5	2. 0	0. 6
ANNUAL	3. 4	2. 2			3. 0	1. 2	3. 4	1. 7
HISTORICAL CUMULATIVE	52. 3	51. 6			24. 2	25. 5	8. 7	7. 9
ANNUAL EQUIVALENT	4. 3	4. 2			5. 6	5. 8	2. 1	1. 9

VERMONT MUNICIPAL EMPLOYEES

ASSET ALLOCATION HISTORY

MUNICIPAL SYSTEM COMPOSITE

QUARTER ENDING	TOTAL VALUE	COMMON STOCK	INT'L C/S	BOND	INT'L BOND	CONV	CASH EQUIV	MORT	REAL ESTATE	SV ASSETS	PRVT INVEST	MISC
06/95	\$71,900,000											100.0
09/95	\$77,000,000											100.0
12/95	\$80,900,000											100.0
03/96	\$83,800,000											100.0
ANNUAL AVERAGE	\$78,400,000	0.0	0.0	0.0	0.0	0.0	0.0	0.0	0.0	0.0	0.0	100.0
06/96	\$86,000,000	0.0		0.0					0.0		0.0	100.0
09/96	\$80,000,000											
12/96	\$96,900,000	49.9	5.2	27.6	9.5		2.8		4.1		0.0	1.0
03/97	\$100,800,000	47.7	4.8	27.2	8.7		6.9		4.0		0.0	1.0
ANNUAL AVERAGE	\$70,925,000	24.4	2.5	13.7	4.6	0.0	2.4	0.0	2.0	0.0	0.0	25.5
06/97	\$100,000,000	52.0	5.0	26.0	8.0		2.0		6.0		0.0	1.0
09/97	\$100,000,000	53.0	5.0	25.0	8.0		2.0		6.0		0.0	1.0
12/97	\$100,000,000	48.0	6.0	28.0	7.0		4.0		7.0		0.0	
03/98	\$129,341,000	57.0	4.1	5.2	7.0		20.8		5.4		0.5	
ANNUAL AVERAGE	\$107,335,250	52.5	5.0	21.1	7.5	0.0	7.2	0.0	6.1	0.0	0.1	0.5
06/98	\$134,807,000	52.4	4.0	26.8	6.8		4.5		5.2		0.3	
09/98	\$126,294,000	44.5	14.9	28.9			5.4		5.7		0.6	
12/98	\$146,172,000	47.0	15.2	28.7			1.8		6.9		0.4	
03/99	\$151,042,000	48.2	14.7	27.4			2.4		6.9		0.4	
ANNUAL AVERAGE	\$139,578,750	48.0	12.2	28.0	1.7	0.0	3.5	0.0	6.2	0.0	0.4	0.0
06/99	\$157,985,000	45.3	14.6	29.2			3.7		6.3		0.9	
09/99	\$152,699,000	43.3	15.5	30.4			3.6		6.8		0.4	
12/99	\$167,650,000	43.5	16.2	27.5			6.0		6.3		0.5	
03/00	\$169,188,000	43.6	15.3	34.2					6.5		0.4	
ANNUAL AVERAGE	\$161,880,500	43.9	15.4	30.3	0.0	0.0	3.3	0.0	6.5	0.0	0.5	0.0

VERMONT MUNICIPAL EMPLOYEES

ASSET ALLOCATION HISTORY

MUNICIPAL SYSTEM COMPOSITE

QUARTER ENDING	TOTAL VALUE	COMMON STOCK	INT'L C/S	BOND	INT'L BOND	CONV	CASH EQUIV	MORT	REAL ESTATE	SV ASSETS	PRVT INVEST	MISC
06/00	\$ 171,940,000	41.6	15.0	36.5					6.4		0.5	
09/00	\$ 168,240,000	44.6	14.5	30.7			2.6		6.9		0.7	
12/00	\$ 176,641,000	42.7	14.6	30.1			4.9		7.1		0.6	
03/01	\$ 163,148,377	40.4	19.0	32.4			0.0		7.6		0.6	
ANNUAL AVERAGE	\$ 168,492,344	42.3	15.8	32.4	0.0	0.0	1.9	0.0	7.0	0.0	0.6	0.0
06/01	\$ 172,114,864	40.8	18.4	31.0			1.9		7.3		0.6	
09/01	\$ 162,816,654	37.6	17.3	34.3			2.4		7.8		0.6	
12/01	\$ 172,055,437	40.3	17.3	31.9			2.4		7.4		0.6	
03/02	\$ 176,976,642	39.3	17.2	35.9					7.0		0.6	
ANNUAL AVERAGE	\$ 171,240,899	39.5	17.6	33.3	0.0	0.0	1.7	0.0	7.4	0.0	0.6	0.0
06/02	\$ 171,715,255	36.9	19.3	33.1			2.8		7.4		0.5	
09/02	\$ 156,188,036	34.9	18.8	32.2			5.4		8.2		0.5	
12/02	\$ 162,064,127	39.1	19.4	31.2			2.1		7.8		0.5	
03/03	\$ 167,152,409	43.1	14.0	32.9			1.7		7.8		0.5	
ANNUAL AVERAGE	\$ 165,029,957	38.5	17.9	32.3	0.0	0.0	3.0	0.0	7.8	0.0	0.5	0.0
06/03	\$ 185,321,463	46.3	15.3	30.8			0.1		7.2		0.4	
09/03	\$ 192,137,407	46.6	15.7	29.8			0.4		7.1		0.4	
12/03	\$ 210,211,569	44.9	16.7	29.9			1.6		6.5		0.4	
03/04	\$ 218,193,787	44.3	16.6	29.6			2.9		6.3		0.3	
ANNUAL AVERAGE	\$ 201,466,057	45.5	16.1	30.0	0.0	0.0	1.2	0.0	6.8	0.0	0.4	0.0
06/04	\$ 220,725,831	45.1	16.3	31.3			0.5		6.4		0.3	
09/04	\$ 222,739,594	43.4	16.5	33.0			0.3		6.4		0.3	
12/04	\$ 233,747,213	45.0	17.5	31.1			0.2		6.0		0.2	
03/05	\$ 238,815,040	42.7	16.6	32.8			0.5		7.1		0.2	
ANNUAL AVERAGE	\$ 230,256,920	44.0	16.7	32.1	0.0	0.0	0.4	0.0	6.5	0.0	0.3	0.0
OVERALL AVERAGE	\$ 149,460,568	37.9	11.9	25.3	1.4	0.0	2.5	0.0	5.6	0.0	0.3	12.6

VERMONT MUNICIPAL EMPLOYEES

ASSET ALLOCATION HISTORY

DOMESTIC EQUITY COMPOSITE

QUARTER ENDING	TOTAL VALUE	COMMON STOCK	INT'L C/S	BOND	INT'L BOND	CONV	CASH EQUIV	MORT	REAL ESTATE	SV ASSETS	PRVT INVEST	MISC
06/95												
09/95												
12/95												
03/96												
ANNUAL AVERAGE	\$0	0.0	0.0	0.0	0.0	0.0	0.0	0.0	0.0	0.0	0.0	0.0
06/96	\$0											
09/96	\$0											
12/96	\$0											
03/97	\$0											
ANNUAL AVERAGE	\$0	0.0	0.0	0.0	0.0	0.0	0.0	0.0	0.0	0.0	0.0	0.0
06/97	\$0											
09/97	\$0											
12/97	\$0											
03/98	\$70,256,000	100.0										
ANNUAL AVERAGE	\$17,564,000	25.0	0.0	0.0	0.0	0.0	0.0	0.0	0.0	0.0	0.0	0.0
06/98	\$67,408,000	100.0										
09/98	\$58,000,000	100.0										
12/98	\$68,698,000	100.0										
03/99	\$72,866,000	100.0										
ANNUAL AVERAGE	\$66,743,000	100.0	0.0	0.0	0.0	0.0	0.0	0.0	0.0	0.0	0.0	0.0
06/99	\$71,308,000	100.0										
09/99	\$65,822,000	100.0										
12/99	\$72,977,000	100.0										
03/00	\$74,396,000	100.0										
ANNUAL AVERAGE	\$71,125,750	100.0	0.0	0.0	0.0	0.0	0.0	0.0	0.0	0.0	0.0	0.0

VERMONT MUNICIPAL EMPLOYEES

ASSET ALLOCATION HISTORY

DOMESTIC EQUITY COMPOSITE

QUARTER ENDING	TOTAL VALUE	COMMON STOCK	INT'L C/S	BOND	INT'L BOND	CONV	CASH EQUIV	MORT	REAL ESTATE	SV ASSETS	PRVT INVEST	MISC
06/00	\$73,237,000	100.0										
09/00	\$73,935,000	100.0										
12/00	\$72,433,000	100.0										
03/01	\$65,831,828	100.0										
ANNUAL AVERAGE	\$71,356,707	100.0	0.0	0.0	0.0	0.0	0.0	0.0	0.0	0.0	0.0	0.0
06/01	\$70,240,677	100.0					0.0					
09/01	\$61,386,357	99.8					0.2					
12/01	\$60,815,580	100.0					0.0					
03/02	\$71,452,309	99.9					0.1					
ANNUAL AVERAGE	\$68,223,731	99.9	0.0	0.0	0.0	0.0	0.1	0.0	0.0	0.0	0.0	0.0
06/02	\$65,908,483	96.1					3.9					
09/02	\$61,299,498	88.9					11.1					
12/02	\$64,513,754	100.0					0.0					
03/03	\$72,026,513	100.0										
ANNUAL AVERAGE	\$65,937,062	96.3	0.0	0.0	0.0	0.0	3.8	0.0	0.0	0.0	0.0	0.0
06/03	\$85,753,952	100.0										
09/03	\$89,498,541	100.0										
12/03	\$94,455,722	100.0										
03/04	\$90,733,008	100.0										
ANNUAL AVERAGE	\$91,610,306	100.0	0.0	0.0	0.0	0.0	0.0	0.0	0.0	0.0	0.0	0.0
06/04	\$99,540,459	100.0										
09/04	\$96,296,101	100.0										
12/04	\$107,766,695	100.0										
03/05	\$102,211,676	99.8					0.2					
ANNUAL AVERAGE	\$101,453,733	99.9	0.0	0.0	0.0	0.0	0.1	0.0	0.0	0.0	0.0	0.0
OVERALL AVERAGE	\$61,557,143	80.1	0.0	0.0	0.0	0.0	0.4	0.0	0.0	0.0	0.0	0.0

VERMONT MUNICIPAL EMPLOYEES

ASSET ALLOCATION HISTORY

DELAWARE

QUARTER ENDING	TOTAL VALUE	COMMON STOCK	INT'L C/S	BOND	INT'L BOND	CONV	CASH EQUIV	MORT	REAL ESTATE	SV ASSETS	PRVT INVEST	MISC
06/95	\$17,514,000	100.0										
09/95	\$18,967,000	100.0										
12/95	\$20,239,000	100.0										
03/96	\$21,315,000	100.0										
ANNUAL AVERAGE	\$19,508,750	100.0	0.0	0.0	0.0	0.0	0.0	0.0	0.0	0.0	0.0	0.0
06/96	\$21,901,000	100.0										
09/96	\$22,773,000	100.0										
12/96	\$24,693,000	100.0										
03/97	\$25,294,000	100.0										
ANNUAL AVERAGE	\$23,665,250	100.0	0.0	0.0	0.0	0.0	0.0	0.0	0.0	0.0	0.0	0.0
06/97	\$29,267,000	100.0										
09/97	\$32,057,000	100.0										
12/97	\$35,888,000	100.0										
03/98	\$36,896,000	100.0										
ANNUAL AVERAGE	\$32,777,000	100.0	0.0	0.0	0.0	0.0	0.0	0.0	0.0	0.0	0.0	0.0
06/98	\$31,460,000	100.0										
09/98	\$27,719,000	100.0										
12/98	\$31,794,000	100.0										
03/99	\$31,985,000	100.0										
ANNUAL AVERAGE	\$30,739,500	100.0	0.0	0.0	0.0	0.0	0.0	0.0	0.0	0.0	0.0	0.0
06/99	\$27,349,000	100.0										
09/99	\$24,719,000	100.0										
12/99	\$25,580,000	100.0										
03/00	\$24,227,000	100.0										
ANNUAL AVERAGE	\$25,468,750	100.0	0.0	0.0	0.0	0.0	0.0	0.0	0.0	0.0	0.0	0.0

VERMONT MUNICIPAL EMPLOYEES

ASSET ALLOCATION HISTORY

DELAWARE

QUARTER ENDING	TOTAL VALUE	COMMON STOCK	INT'L C/S	BOND	INT'L BOND	CONV	CASH EQUIV	MORT	REAL ESTATE	SV ASSETS	PRVT INVEST	MISC
06/00	\$24,252,000	100.0										
09/00	\$26,354,000	100.0										
12/00	\$26,984,000	100.0										
03/01	\$27,843,000	100.0										
ANNUAL AVERAGE	\$26,858,250	100.0	0.0	0.0	0.0	0.0	0.0	0.0	0.0	0.0	0.0	0.0
06/01	\$28,924,644	99.9					0.1					
09/01	\$28,632,004	99.6					0.4					
12/01	\$27,873,588	99.9					0.1					
03/02	\$29,421,666	99.9					0.1					
ANNUAL AVERAGE	\$27,962,976	99.8	0.0	0.0	0.0	0.0	0.2	0.0	0.0	0.0	0.0	0.0
06/02	\$27,207,577	98.0					2.0					
09/02	\$27,136,855	99.8					0.3					
12/02	\$25,908,736	100.0					0.0					
03/03	\$26,934,653	100.0										
ANNUAL AVERAGE	\$25,046,955	99.4	0.0	0.0	0.0	0.0	0.6	0.0	0.0	0.0	0.0	0.0
06/03	\$33,472,227	100.0										
09/03	\$34,328,601	100.0										
12/03	\$37,659,710	100.0										
03/04	\$36,328,861	100.0										
ANNUAL AVERAGE	\$35,947,350	100.0	0.0	0.0	0.0	0.0	0.0	0.0	0.0	0.0	0.0	0.0
06/04	\$39,060,113	100.0										
09/04	\$38,601,324	100.0										
12/04	\$41,975,083	100.0										
03/05	\$41,437,411	99.4					0.6					
ANNUAL AVERAGE	\$40,268,483	99.9	0.0	0.0	0.0	0.0	0.1	0.0	0.0	0.0	0.0	0.0
OVERALL AVERAGE	\$28,824,326	99.9	0.0	0.0	0.0	0.0	0.1	0.0	0.0	0.0	0.0	0.0

VERMONT MUNICIPAL EMPLOYEES

ASSET ALLOCATION HISTORY

ALLIANCE LARGE CAP GROWTH FUND

QUARTER ENDING	TOTAL VALUE	COMMON STOCK	INT'L C/S	BOND	INT'L BOND	CONV	CASH EQUIV	MORT	REAL ESTATE	SV ASSETS	PRVT INVEST	MISC
06/95	\$ 11,588,000	100.0										
09/95	\$ 12,952,000	100.0										
12/95	\$ 12,889,000	100.0										
03/96	\$ 17,473,000	100.0										
ANNUAL AVERAGE	\$ 13,725,500	100.0	0.0	0.0	0.0	0.0	0.0	0.0	0.0	0.0	0.0	0.0
06/96	\$ 18,133,000	100.0										
09/96	\$ 18,720,000	100.0										
12/96	\$ 20,779,000	100.0										
03/97	\$ 20,525,000	100.0										
ANNUAL AVERAGE	\$ 19,539,250	100.0	0.0	0.0	0.0	0.0	0.0	0.0	0.0	0.0	0.0	0.0
06/97	\$ 24,652,000	100.0										
09/97	\$ 27,935,000	100.0										
12/97	\$ 27,433,000	100.0										
03/98	\$ 33,360,000	100.0										
ANNUAL AVERAGE	\$ 28,345,000	100.0	0.0	0.0	0.0	0.0	0.0	0.0	0.0	0.0	0.0	0.0
06/98	\$ 35,948,000	100.0										
09/98	\$ 27,952,000	100.0										
12/98	\$ 36,903,000	100.0										
03/99	\$ 40,881,000	100.0										
ANNUAL AVERAGE	\$ 35,421,000	100.0	0.0	0.0	0.0	0.0	0.0	0.0	0.0	0.0	0.0	0.0
06/99	\$ 29,988,000	100.0										
09/99	\$ 28,421,000	100.0										
12/99	\$ 34,587,000	100.0										
03/00	\$ 36,857,000	100.0										
ANNUAL AVERAGE	\$ 32,463,250	100.0	0.0	0.0	0.0	0.0	0.0	0.0	0.0	0.0	0.0	0.0

VERMONT MUNICIPAL EMPLOYEES

ASSET ALLOCATION HISTORY

ALLIANCE LARGE CAP GROWTH FUND

QUARTER ENDING	TOTAL VALUE	COMMON STOCK	INT'L C/S	BOND	INT'L BOND	CONV	CASH EQUIV	MORT	REAL ESTATE	SV ASSETS	PRVT INVEST	MISC
06/00	\$35,650,000	100.0										
09/00	\$33,578,000	100.0										
12/00	\$33,593,000	100.0										
03/01	\$23,603,000	100.0										
ANNUAL AVERAGE	\$30,356,000	100.0	0.0	0.0	0.0	0.0	0.0	0.0	0.0	0.0	0.0	0.0
06/01	\$25,081,654	100.0					0.0					
09/01	\$21,192,830	100.0					0.0					
12/01	\$24,414,973	100.0					0.0					
03/02	\$23,284,861	100.0					0.0					
ANNUAL AVERAGE	\$23,493,580	100.0	0.0	0.0	0.0	0.0	0.0	0.0	0.0	0.0	0.0	0.0
06/02	\$21,688,804	90.7					9.3					
09/02	\$23,499,088	71.2					28.8					
12/02	\$21,168,257	100.0										
03/03	\$20,486,854	100.0										
ANNUAL AVERAGE	\$24,460,751	90.5	0.0	0.0	0.0	0.0	9.5	0.0	0.0	0.0	0.0	0.0
06/03	\$32,107,299	100.0										
09/03	\$33,368,796	100.0										
12/03	\$34,121,301	100.0										
03/04	\$34,670,760	100.0										
ANNUAL AVERAGE	\$33,567,039	100.0	0.0	0.0	0.0	0.0	0.0	0.0	0.0	0.0	0.0	0.0
06/04	\$36,309,751	100.0										
09/04	\$34,225,443	100.0										
12/04	\$33,568,923	100.0										
03/05	\$37,115,764	100.0										
ANNUAL AVERAGE	\$36,804,970	100.0	0.0	0.0	0.0	0.0	0.0	0.0	0.0	0.0	0.0	0.0
OVERALL AVERAGE	\$27,817,634	99.0	0.0	0.0	0.0	0.0	1.0	0.0	0.0	0.0	0.0	0.0

VERMONT MUNICIPAL EMPLOYEES

ASSET ALLOCATION HISTORY

LAZARD SMALL CAP FUND

QUARTER ENDING	TOTAL VALUE	COMMON STOCK	INT'L C/S	BOND	INT'L BOND	CONV	CASH EQUIV	MORT	REAL ESTATE	SV ASSETS	PRVT INVEST	MISC
06/95												
09/95												
12/95												
03/96												
ANNUAL AVERAGE	\$ 0	0.0	0.0	0.0	0.0	0.0	0.0	0.0	0.0	0.0	0.0	0.0
06/96												
09/96												
12/96												
03/97												
ANNUAL AVERAGE	\$ 0	0.0	0.0	0.0	0.0	0.0	0.0	0.0	0.0	0.0	0.0	0.0
06/97												
09/97												
12/97												
03/98												
ANNUAL AVERAGE	\$ 0	0.0	0.0	0.0	0.0	0.0	0.0	0.0	0.0	0.0	0.0	0.0
06/98												
09/98												
12/98												
03/99												
ANNUAL AVERAGE	\$ 0	0.0	0.0	0.0	0.0	0.0	0.0	0.0	0.0	0.0	0.0	0.0
06/99	\$ 13,970,000	100.0										
09/99	\$ 12,682,000	100.0										
12/99	\$ 12,810,000	100.0										
03/00	\$ 13,312,000	100.0										
ANNUAL AVERAGE	\$ 13,193,500	100.0	0.0	0.0	0.0	0.0	0.0	0.0	0.0	0.0	0.0	0.0

VERMONT MUNICIPAL EMPLOYEES

ASSET ALLOCATION HISTORY

LAZARD SMALL CAP FUND

QUARTER ENDING	TOTAL VALUE	COMMON STOCK	INT'L C/S	BOND	INT'L BOND	CONV	CASH EQUIV	MORT	REAL ESTATE	SV ASSETS	PRVT INVEST	MISC
06/00	\$ 13,335,000	100.0										
09/00	\$ 14,003,000	100.0										
12/00	\$ 14,846,000	100.0										
03/01	\$ 14,385,828	100.0										
ANNUAL AVERAGE	\$ 14,142,457	100.0	0.0	0.0	0.0	0.0	0.0	0.0	0.0	0.0	0.0	0.0
06/01	\$ 16,234,379	100.0										
09/01	\$ 14,561,523	100.0										
12/01	\$ 17,527,019	100.0										
03/02	\$ 18,745,782	100.0										
ANNUAL AVERAGE	\$ 16,767,176	100.0	0.0	0.0	0.0	0.0	0.0	0.0	0.0	0.0	0.0	0.0
06/02	\$ 17,012,102	100.0										
09/02	\$ 15,663,555	100.0										
12/02	\$ 18,436,761	100.0										
03/03	\$ 16,605,006	100.0										
ANNUAL AVERAGE	\$ 16,429,356	100.0	0.0	0.0	0.0	0.0	0.0	0.0	0.0	0.0	0.0	0.0
06/03	\$ 20,174,426	100.0										
09/03	\$ 21,801,144	100.0										
12/03	\$ 22,674,711	100.0										
03/04	\$ 23,733,387	100.0										
ANNUAL AVERAGE	\$ 22,095,917	100.0	0.0	0.0	0.0	0.0	0.0	0.0	0.0	0.0	0.0	0.0
06/04	\$ 24,170,595	100.0										
09/04	\$ 23,469,334	100.0										
12/04	\$ 28,222,689	100.0										
03/05	\$ 23,658,501	100.0										
ANNUAL AVERAGE	\$ 24,380,280	100.0	0.0	0.0	0.0	0.0	0.0	0.0	0.0	0.0	0.0	0.0
OVERALL AVERAGE	\$ 17,834,781	100.0	0.0	0.0	0.0	0.0	0.0	0.0	0.0	0.0	0.0	0.0

VERMONT MUNICIPAL EMPLOYEES

ASSET ALLOCATION HISTORY

BRINSON - UBS

QUARTER ENDING	TOTAL VALUE	COMMON STOCK	INT'L C/S	BOND	INT'L BOND	CONV	CASH EQUIV	MORT	REAL ESTATE	SV ASSETS	PRVT INVEST	MISC
06/95	\$15,163,000		100.0									
09/95	\$16,086,000		100.0									
12/95	\$17,023,000		100.0									
03/96	\$19,474,000		100.0									
ANNUAL AVERAGE	\$16,936,500	0.0	100.0	0.0	0.0	0.0	0.0	0.0	0.0	0.0	0.0	0.0
06/96	\$19,977,000		100.0									
09/96	\$20,513,000		100.0									
12/96	\$21,422,000		100.0									
03/97	\$21,111,000		100.0									
ANNUAL AVERAGE	\$20,755,750	0.0	100.0	0.0	0.0	0.0	0.0	0.0	0.0	0.0	0.0	0.0
06/97	\$22,605,000		100.0									
09/97	\$23,144,000		100.0									
12/97	\$23,817,000		100.0									
03/98	\$24,028,000		100.0									
ANNUAL AVERAGE	\$23,148,500	0.0	100.0	0.0	0.0	0.0	0.0	0.0	0.0	0.0	0.0	0.0
06/98	\$24,235,000		100.0									
09/98	\$24,188,000		100.0									
12/98	\$22,289,000		100.0									
03/99	\$22,269,000		100.0									
ANNUAL AVERAGE	\$23,245,250	0.0	100.0	0.0	0.0	0.0	0.0	0.0	0.0	0.0	0.0	0.0
06/99	\$23,069,000		100.0									
09/99	\$23,660,000		100.0									
12/99	\$27,156,000		100.0									
03/00	\$26,222,000		100.0									
ANNUAL AVERAGE	\$25,026,750	0.0	100.0	0.0	0.0	0.0	0.0	0.0	0.0	0.0	0.0	0.0

VERMONT MUNICIPAL EMPLOYEES

ASSET ALLOCATION HISTORY

BRINSON - UBS

QUARTER ENDING	TOTAL VALUE	COMMON STOCK	INT'L C/S	BOND	INT'L BOND	CONV	CASH EQUIV	MORT	REAL ESTATE	SV ASSETS	PRVT INVEST	MISC
06/00	\$26,395,000		100.0									
09/00	\$24,448,000		100.0									
12/00	\$24,917,000		100.0									
03/01	\$30,994,000		100.0									
ANNUAL AVERAGE	\$26,688,500	0.0	100.0	0.0	0.0	0.0	0.0	0.0	0.0	0.0	0.0	0.0
06/01	\$31,623,739		100.0									
09/01	\$28,143,429		100.0				0.0					
12/01	\$30,301,064		100.0				0.0					
03/02	\$31,307,322		100.0				0.0					
ANNUAL AVERAGE	\$30,343,889	0.0	100.0	0.0	0.0	0.0	0.0	0.0	0.0	0.0	0.0	0.0
06/02	\$33,162,921		100.0				0.0					
09/02	\$29,362,509		100.0				0.0					
12/02	\$37,983,528		100.0				0.0					
03/03	\$23,481,991		100.0				0.0					
ANNUAL AVERAGE	\$29,497,737	0.0	100.0	0.0	0.0	0.0	0.0	0.0	0.0	0.0	0.0	0.0
06/03	\$28,264,951		100.0				0.0					
09/03	\$30,220,275		100.0				0.0					
12/03	\$33,151,536		100.0				0.0					
03/04	\$36,136,452		100.0				0.0					
ANNUAL AVERAGE	\$32,443,304	0.0	100.0	0.0	0.0	0.0	0.0	0.0	0.0	0.0	0.0	0.0
06/04	\$36,072,855		100.0				0.0					
09/04	\$36,639,208		100.0				0.0					
12/04	\$41,888,190		100.0				0.0					
03/05	\$39,723,228		100.0				0.0					
ANNUAL AVERAGE	\$38,580,870	0.0	100.0	0.0	0.0	0.0	0.0	0.0	0.0	0.0	0.0	0.0
OVERALL AVERAGE	\$26,666,705	0.0	100.0	0.0	0.0	0.0	0.0	0.0	0.0	0.0	0.0	0.0

VERMONT MUNICIPAL EMPLOYEES

ASSET ALLOCATION HISTORY

MET LIFE / SSR TOWER FUND

QUARTER ENDING	TOTAL VALUE	COMMON STOCK	INT'L C/S	BOND	INT'L BOND	CONV	CASH EQUIV	MORT	REAL ESTATE	SV ASSETS	PRVT INVEST	MISC
06/95	\$1,860,000								100.0			
09/95	\$1,886,000								100.0			
12/95	\$1,927,000								100.0			
03/96	\$1,856,000								100.0			
ANNUAL AVERAGE	\$1,882,250	0.0	0.0	0.0	0.0	0.0	0.0	0.0	100.0	0.0	0.0	0.0
06/96	\$739,000								100.0			
09/96	\$739,000								100.0			
12/96	\$749,000								100.0			
03/97	\$4,045,000								100.0			
ANNUAL AVERAGE	\$1,568,000	0.0	0.0	0.0	0.0	0.0	0.0	0.0	100.0	0.0	0.0	0.0
06/97	\$6,572,000								100.0			
09/97	\$6,652,000								100.0			
12/97	\$7,838,000								100.0			
03/98	\$7,020,000								100.0			
ANNUAL AVERAGE	\$6,770,500	0.0	0.0	0.0	0.0	0.0	0.0	0.0	100.0	0.0	0.0	0.0
06/98	\$7,020,000								100.0			
09/98	\$7,248,000								100.0			
12/98	\$10,085,000								100.0			
03/99	\$10,389,000								100.0			
ANNUAL AVERAGE	\$8,685,500	0.0	0.0	0.0	0.0	0.0	0.0	0.0	100.0	0.0	0.0	0.0
06/99	\$10,024,000								100.0			
09/99	\$10,340,000								100.0			
12/99	\$11,598,000								100.0			
03/00	\$11,208,000								100.0			
ANNUAL AVERAGE	\$10,542,500	0.0	0.0	0.0	0.0	0.0	0.0	0.0	100.0	0.0	0.0	0.0

VERMONT MUNICIPAL EMPLOYEES

ASSET ALLOCATION HISTORY

MET LIFE / SSR TOWER FUND

QUARTER ENDING	TOTAL VALUE	COMMON STOCK	INT'L C/S	BOND	INT'L BOND	CONV	CASH EQUIV	MORT	REAL ESTATE	SV ASSETS	PRVT INVEST	MISC
06/00	\$ 11,355,000								100.0			
09/00	\$ 11,672,000								100.0			
12/00	\$ 12,181,000								100.0			
03/01	\$ 12,403,000								100.0			
ANNUAL AVERAGE	\$ 11,902,750	0.0	0.0	0.0	0.0	0.0	0.0	0.0	100.0	0.0	0.0	0.0
06/01	\$ 12,628,498								100.0			
09/01	\$ 12,698,462								100.0			
12/01	\$ 12,739,786								100.0			
03/02	\$ 12,705,292								100.0			
ANNUAL AVERAGE	\$ 12,693,010	0.0	0.0	0.0	0.0	0.0	0.0	0.0	100.0	0.0	0.0	0.0
06/02	\$ 12,782,391								100.0			
09/02	\$ 12,798,823								100.0			
12/02	\$ 12,889,065								100.0			
03/03	\$ 13,086,370								100.0			
ANNUAL AVERAGE	\$ 12,889,162	0.0	0.0	0.0	0.0	0.0	0.0	0.0	100.0	0.0	0.0	0.0
06/03	\$ 13,334,203								100.0			
09/03	\$ 13,620,576								100.0			
12/03	\$ 13,660,495								100.0			
03/04	\$ 13,766,796								100.0			
ANNUAL AVERAGE	\$ 13,595,518	0.0	0.0	0.0	0.0	0.0	0.0	0.0	100.0	0.0	0.0	0.0
06/04	\$ 14,125,010								100.0			
09/04	\$ 14,105,906								100.0			
12/04	\$ 14,404,492								100.0			
03/05	\$ 17,002,951								100.0			
ANNUAL AVERAGE	\$ 14,909,590	0.0	0.0	0.0	0.0	0.0	0.0	0.0	100.0	0.0	0.0	0.0
OVERALL AVERAGE	\$ 9,543,878	0.0	0.0	0.0	0.0	0.0	0.0	0.0	100.0	0.0	0.0	0.0

VERMONT MUNICIPAL EMPLOYEES

ASSET ALLOCATION HISTORY

SEIX CORE

QUARTER ENDING	TOTAL VALUE	COMMON STOCK	INT'L C/S	BOND	INT'L BOND	CONV	CASH EQUIV	MORT	REAL ESTATE	SV ASSETS	PRVT INVEST	MISC
06/95 09/95 12/95 03/96												
ANNUAL AVERAGE	\$0	0.0	0.0	0.0	0.0	0.0	0.0	0.0	0.0	0.0	0.0	0.0
06/96 09/96 12/96 03/97												
ANNUAL AVERAGE	\$0	0.0	0.0	0.0	0.0	0.0	0.0	0.0	0.0	0.0	0.0	0.0
06/97 09/97 12/97 03/98												
ANNUAL AVERAGE	\$0	0.0	0.0	0.0	0.0	0.0	0.0	0.0	0.0	0.0	0.0	0.0
06/98 09/98 12/98 03/99												
ANNUAL AVERAGE	\$0	0.0	0.0	0.0	0.0	0.0	0.0	0.0	0.0	0.0	0.0	0.0
06/99 09/99 12/99 03/00	\$52,397,000			100.0								
ANNUAL AVERAGE	\$52,397,000	0.0	0.0	100.0	0.0	0.0	0.0	0.0	0.0	0.0	0.0	0.0

VERMONT MUNICIPAL EMPLOYEES

ASSET ALLOCATION HISTORY

SEIX CORE

QUARTER ENDING	TOTAL VALUE	COMMON STOCK	INT'L C/S	BOND	INT'L BOND	CONV	CASH EQUIV	MORT	REAL ESTATE	SV ASSETS	PRVT INVEST	MISC
06/00	\$53,366,000			100.0								
09/00	\$52,106,000			100.0								
12/00	\$52,610,000			100.0								
03/01	\$52,337,307			100.0								
ANNUAL AVERAGE	\$54,604,827	0.0	0.0	100.0	0.0	0.0	0.0	0.0	0.0	0.0	0.0	0.0
06/01	\$52,723,091			100.0			0.0					
09/01	\$51,135,870			100.0								
12/01	\$51,462,538			100.0								
03/02	\$54,539,509			100.0								
ANNUAL AVERAGE	\$54,215,252	0.0	0.0	100.0	0.0	0.0	0.0	0.0	0.0	0.0	0.0	0.0
06/02	\$56,149,808			100.0								
09/02	\$54,646,988			100.0								
12/02	\$54,739,841			100.0								
03/03	\$54,640,083			100.0								
ANNUAL AVERAGE	\$52,794,180	0.0	0.0	100.0	0.0	0.0	0.0	0.0	0.0	0.0	0.0	0.0
06/03	\$47,733,386			100.0								
09/03	\$47,723,141			100.0								
12/03	\$51,966,772			100.0								
03/04	\$53,341,763			100.0								
ANNUAL AVERAGE	\$50,191,266	0.0	0.0	100.0	0.0	0.0	0.0	0.0	0.0	0.0	0.0	0.0
06/04	\$58,213,956			100.0								
09/04	\$61,796,577			100.0								
12/04	\$62,842,119			100.0								
03/05	\$62,697,950			100.0								
ANNUAL AVERAGE	\$62,137,651	0.0	0.0	100.0	0.0	0.0	0.0	0.0	0.0	0.0	0.0	0.0
OVERALL AVERAGE	\$54,674,748	0.0	0.0	100.0	0.0	0.0	0.0	0.0	0.0	0.0	0.0	0.0

VERMONT MUNICIPAL EMPLOYEES

ASSET ALLOCATION HISTORY

SEIX HIGH YIELD

QUARTER ENDING	TOTAL VALUE	COMMON STOCK	INT'L C/S	BOND	INT'L BOND	CONV	CASH EQUIV	MORT	REAL ESTATE	SV ASSETS	PRVT INVEST	MISC
06/00												
09/00												
12/00												
03/01												
ANNUAL AVERAGE	\$0	0.0	0.0	0.0	0.0	0.0	0.0	0.0	0.0	0.0	0.0	0.0
06/01												
09/01												
12/01												
03/02												
ANNUAL AVERAGE	\$0	0.0	0.0	0.0	0.0	0.0	0.0	0.0	0.0	0.0	0.0	0.0
06/02												
09/02												
12/02												
03/03												
ANNUAL AVERAGE	\$0	0.0	0.0	0.0	0.0	0.0	0.0	0.0	0.0	0.0	0.0	0.0
06/03	\$9,054,927			100.0								
09/03	\$8,137,381			100.0								
12/03	\$10,578,524			100.0								
03/04	\$10,804,414			100.0								
ANNUAL AVERAGE	\$9,893,812	0.0	0.0	100.0	0.0	0.0	0.0	0.0	0.0	0.0	0.0	0.0
06/04	\$10,631,852			100.0								
09/04	\$11,144,985			100.0			0.0					
12/04	\$11,461,056			100.0								
03/05	\$12,268,684			100.0								
ANNUAL AVERAGE	\$11,376,644	0.0	0.0	100.0	0.0	0.0	0.0	0.0	0.0	0.0	0.0	0.0
OVERALL AVERAGE	\$10,635,228	0.0	0.0	100.0	0.0	0.0	0.0	0.0	0.0	0.0	0.0	0.0

VERMONT MUNICIPAL EMPLOYEES

ASSET ALLOCATION HISTORY

ALTERNATIVE INVESTMENTS

QUARTER ENDING	TOTAL VALUE	COMMON STOCK	INT'L C/S	BOND	INT'L BOND	CONV	CASH EQUIV	MORT	REAL ESTATE	SV ASSETS	PRVT INVEST	MISC
06/95	\$601,000										100.0	
09/95	\$570,000										100.0	
12/95	\$570,000										100.0	
03/96	\$613,000										100.0	
ANNUAL AVERAGE	\$588,500	0.0	0.0	0.0	0.0	0.0	0.0	0.0	0.0	0.0	100.0	0.0
06/96	\$614,000										100.0	
09/96	\$606,000										100.0	
12/96	\$606,000										100.0	
03/97	\$614,000										100.0	
ANNUAL AVERAGE	\$610,000	0.0	0.0	0.0	0.0	0.0	0.0	0.0	0.0	0.0	100.0	0.0
06/97	\$602,000										100.0	
09/97	\$611,000										100.0	
12/97	\$605,000										100.0	
03/98	\$605,000										100.0	
ANNUAL AVERAGE	\$605,750	0.0	0.0	0.0	0.0	0.0	0.0	0.0	0.0	0.0	100.0	0.0
06/98	\$606,000										100.0	
09/98	\$606,000										100.0	
12/98	\$606,000										100.0	
03/99	\$606,000										100.0	
ANNUAL AVERAGE	\$606,000	0.0	0.0	0.0	0.0	0.0	0.0	0.0	0.0	0.0	100.0	0.0
06/99	\$674,000										100.0	
09/99	\$674,000										100.0	
12/99	\$674,000										100.0	
03/00	\$674,000										100.0	
ANNUAL AVERAGE	\$674,000	0.0	0.0	0.0	0.0	0.0	0.0	0.0	0.0	0.0	100.0	0.0

VERMONT MUNICIPAL EMPLOYEES

ASSET ALLOCATION HISTORY

ALTERNATIVE INVESTMENTS

QUARTER ENDING	TOTAL VALUE	COMMON STOCK	INT'L C/S	BOND	INT'L BOND	CONV	CASH EQUIV	MORT	REAL ESTATE	SV ASSETS	PRVT INVEST	MISC
06/00	\$1,036,000										100.0	
09/00	\$1,036,000										100.0	
12/00	\$1,037,000										100.0	
03/01	\$1,056,137						1.3				98.7	
ANNUAL AVERAGE	\$1,041,284	0.0	0.0	0.0	0.0	0.0	0.3	0.0	0.0	0.0	99.7	0.0
06/01	\$1,116,579						6.6				93.4	
09/01	\$1,117,282						6.7				93.3	
12/01	\$1,117,792						6.7				93.3	
03/02	\$1,118,176						6.8				93.3	
ANNUAL AVERAGE	\$1,117,457	0.0	0.0	0.0	0.0	0.0	6.7	0.0	0.0	0.0	93.3	0.0
06/02	\$886,926						8.6				91.5	
09/02	\$887,273						8.6				91.4	
12/02	\$887,581						8.6				91.4	
03/03	\$887,819						8.6				91.4	
ANNUAL AVERAGE	\$887,400	0.0	0.0	0.0	0.0	0.0	8.6	0.0	0.0	0.0	91.4	0.0
06/03	\$829,498						9.3				90.7	
09/03	\$829,689						9.3				90.7	
12/03	\$829,881						9.3				90.7	
03/04	\$830,073						9.3				90.7	
ANNUAL AVERAGE	\$829,785	0.0	0.0	0.0	0.0	0.0	9.3	0.0	0.0	0.0	90.7	0.0
06/04	\$830,258						9.4				90.6	
09/04	\$830,501						9.4				90.6	
12/04	\$739,976						21.4				78.6	
03/05	\$740,729						21.5				78.5	
ANNUAL AVERAGE	\$785,366	0.0	0.0	0.0	0.0	0.0	15.4	0.0	0.0	0.0	84.6	0.0
OVERALL AVERAGE	\$774,554	0.0	0.0	0.0	0.0	0.0	4.0	0.0	0.0	0.0	96.0	0.0

VERMONT MUNICIPAL EMPLOYEES

ASSET ALLOCATION HISTORY

VERMONT INVESTMENTS

QUARTER ENDING	TOTAL VALUE	COMMON STOCK	INT'L C/S	BOND	INT'L BOND	CONV	CASH EQUIV	MORT	REAL ESTATE	SV ASSETS	PRVT INVEST	MISC
06/95	\$3,196,000						100.0					
09/95	\$4,038,000						100.0					
12/95	\$2,592,000						100.0					
03/96	\$2,034,000						100.0					
ANNUAL AVERAGE	\$3,465,000	0.0	0.0	0.0	0.0	0.0	100.0	0.0	0.0	0.0	0.0	0.0
06/96	\$3,359,000						100.0					
09/96	\$2,435,000						100.0					
12/96	\$2,345,000						100.0					
03/97	\$7,030,000						100.0					
ANNUAL AVERAGE	\$5,542,250	0.0	0.0	0.0	0.0	0.0	100.0	0.0	0.0	0.0	0.0	0.0
06/97	\$2,826,000						100.0					
09/97	\$2,484,000						100.0					
12/97	\$1,899,000						100.0					
03/98	\$2,671,000						100.0					
ANNUAL AVERAGE	\$2,470,000	0.0	0.0	0.0	0.0	0.0	100.0	0.0	0.0	0.0	0.0	0.0
06/98	\$5,311,000						100.0					
09/98	\$2,566,000						100.0					
12/98	\$2,136,000						100.0					
03/99	\$4,155,000						100.0					
ANNUAL AVERAGE	\$3,792,000	0.0	0.0	0.0	0.0	0.0	100.0	0.0	0.0	0.0	0.0	0.0
06/99	\$6,676,000						100.0					
09/99	\$3,699,000						100.0					
12/99	\$3,978,000						100.0					
03/00	\$4,291,000						100.0					
ANNUAL AVERAGE	\$6,661,000	0.0	0.0	0.0	0.0	0.0	100.0	0.0	0.0	0.0	0.0	0.0

VERMONT MUNICIPAL EMPLOYEES

ASSET ALLOCATION HISTORY

VERMONT INVESTMENTS

QUARTER ENDING	TOTAL VALUE	COMMON STOCK	INT'L C/S	BOND	INT'L BOND	CONV	CASH EQUIV	MORT	REAL ESTATE	SV ASSETS	PRVT INVEST	MISC
06/00	\$6,551,000						100.0					
09/00	\$5,044,000						100.0					
12/00	\$2,473,000						100.0					
03/01	\$526,105			100.0								
ANNUAL AVERAGE	\$2,898,526	0.0	0.0	25.0	0.0	0.0	75.0	0.0	0.0	0.0	0.0	0.0
06/01	\$3,782,280			17.6			82.4					
09/01	\$4,335,254			15.2			84.8					
12/01	\$1,618,675			14.2			85.8					
03/02	\$3,854,034			11.0			89.0					
ANNUAL AVERAGE	\$4,647,561	0.0	0.0	14.5	0.0	0.0	85.5	0.0	0.0	0.0	0.0	0.0
06/02	\$2,824,726			23.8			76.2					
09/02	\$5,192,945			31.4			68.6					
12/02	\$4,050,358			17.0			83.0					
03/03	\$3,029,633			10.8			89.2					
ANNUAL AVERAGE	\$3,024,416	0.0	0.0	20.7	0.0	0.0	79.3	0.0	0.0	0.0	0.0	0.0
06/03	\$350,546			95.0			5.0					
09/03	\$1,107,804			30.7			69.3					
12/03	\$3,568,639			9.2			90.8					
03/04	\$6,581,281			5.1			94.9					
ANNUAL AVERAGE	\$2,902,068	0.0	0.0	35.0	0.0	0.0	65.0	0.0	0.0	0.0	0.0	0.0
06/04	\$1,311,441			25.0			75.0					
09/04	\$926,316			33.4			66.6					
12/04	\$644,685			48.6			51.4					
03/05	\$1,169,822			27.1			72.9					
ANNUAL AVERAGE	\$1,013,066	0.0	0.0	33.5	0.0	0.0	66.5	0.0	0.0	0.0	0.0	0.0
OVERALL AVERAGE	\$3,641,589	0.0	0.0	12.9	0.0	0.0	87.1	0.0	0.0	0.0	0.0	0.0

VERMONT MUNICIPAL EMPLOYEES

POLICY INDEX DETAIL

POLICY ACCOUNT: R2W0200

MUNI POLICY INDEX

EFFECTIVE DATE: 03/ 92

40% S&P 500
5% 90 DAY T-BILLS
5% NCREIF CL PROP

35% LB AGGREGATE
5% PRIVATE EQ 12%

5% SSB WGBI EX US
5% MS EAFE NET

EFFECTIVE DATE: 03/ 96

48% S&P 500
7% CITI WGBI EX US

28% LB AGGREGATE
6% MS EAFE NET

7% NCREIF CL PROP
4% PRIVATE EQ 12%

EFFECTIVE DATE: 03/ 98

48% S&P 500
6% MS EAFE NET

30% LB AGGREGATE
5% CITI WGBI EX US

7% NCREIF CL PROP
4% PRIVATE EQ 12%

EFFECTIVE DATE: 09/ 98

43% S&P 500
7% NCREIF CL PROP

32% LB AGGREGATE
4% PRIVATE EQ 13%

14% MS EAFE NET

EFFECTIVE DATE: 03/ 01

30% LB AGGREGATE
15% R 1000(R) GR
2% PRIVATE EQ 13%

20% MS EAFE NET
10% R 2000(R)

16% R 1000(R) VALUE
7% NCREIF CL PROP

EFFECTIVE DATE: 10/ 02

32% LB AGGREGATE
14% MS EAFE NET
4% PRIVATE EQ 13%

17% R 1000(R) VALUE
10% R 2000(R)

16% R 1000(R) GR
7% NCREIF CL PROP

EFFECTIVE DATE: 05/ 03

27% LB AGGREGATE

17% R 1000(R) VALUE

16% R 1000(R) GR

VERMONT MUNICIPAL EMPLOYEES

POLICY INDEX DETAIL

16% MS EAFE NET
5% ML HIGH YIELD

10% R 2000(R)
2% PRIVATE EQ 13%

7% NCREIF PROPERTY

VERMONT MUNICIPAL EMPLOYEES

ALLOCATION INDEX DETAIL

ACCOUNT: R2W0201 DELAWARE

EFFECTIVE DATE: 06/ 00

COMMON STOCK:	S&P VALUE	CONVERTIBLES:	FB CONV BOND
CASH EQUIV.:	90 DAY T-BILLS	BONDS:	LB AGGREGATE
MORTGAGES:	CITI MORTGAGE	REAL ESTATE:	NCREIF CL PROP
INTL COMMON STK:	MS EAFE NET	INT'L BONDS:	ML WORLD BOND
STABLE VAL ASTS:	5YR GIC ROR	MISC:	DELAWARE
PRIVATE INVEST:	NASDAQ COMP	CASH:	DELAWARE

EFFECTIVE DATE: 10/ 02

COMMON STOCK:	R 1000(R) VALUE	CONVERTIBLES:	FB CONV BOND
CASH EQUIV.:	90 DAY T-BILLS	BONDS:	LB AGGREGATE
MORTGAGES:	CITI MORTGAGE	REAL ESTATE:	NCREIF CL PROP
INTL COMMON STK:	MS EAFE NET	INT'L BONDS:	ML WORLD BOND
STABLE VAL ASTS:	5YR GIC ROR	MISC:	DELAWARE
PRIVATE INVEST:	NASDAQ COMP	CASH:	DELAWARE

ACCOUNT: R2W0202 ALLIANCE LARGE CAP GROWTH FUND

EFFECTIVE DATE: 06/ 00

COMMON STOCK:	R 1000(R) GR	CONVERTIBLES:	FB CONV BOND
CASH EQUIV.:	90 DAY T-BILLS	BONDS:	LB AGGREGATE
MORTGAGES:	CITI MORTGAGE	REAL ESTATE:	NCREIF CL PROP
INTL COMMON STK:	MS EAFE NET	INT'L BONDS:	ML WORLD BOND
STABLE VAL ASTS:	5YR GIC ROR	MISC:	ALLIANCE
PRIVATE INVEST:	NASDAQ COMP	CASH:	ALLIANCE

VERMONT MUNICIPAL EMPLOYEES

ALLOCATION INDEX DETAIL

ACCOUNT: R2W0203

LAZARD SMALL CAP FUND

EFFECTIVE DATE: 06/00

COMMON STOCK:	R 2000(R)	CONVERTIBLES:	FB CONV BOND
CASH EQUIV.:	90 DAY T-BILLS	BONDS:	LB AGGREGATE
MORTGAGES:	CITI MORTGAGE	REAL ESTATE:	NCREIF CL PROP
INTL COMMON STK:	MS EAFE NET	INT'L BONDS:	ML WORLD BOND
STABLE VAL ASTS:	5YR GIC ROR	MISC:	LAZARD
PRIVATE INVEST:	NASDAQ COMP	CASH:	LAZARD

ACCOUNT: R2W0204

BRINSON - UBS

EFFECTIVE DATE: 06/00

COMMON STOCK:	S&P 500	CONVERTIBLES:	FB CONV BOND
CASH EQUIV.:	90 DAY T-BILLS	BONDS:	LB AGGREGATE
MORTGAGES:	CITI MORTGAGE	REAL ESTATE:	NCREIF CL PROP
INTL COMMON STK:	MS EAFE NET	INT'L BONDS:	ML WORLD BOND
STABLE VAL ASTS:	5YR GIC ROR	MISC:	UBS
PRIVATE INVEST:	NASDAQ COMP	CASH:	UBS

ACCOUNT: R2W0207

MET LIFE / SSR TOWER FUND

EFFECTIVE DATE: 06/00

COMMON STOCK:	S&P 500	CONVERTIBLES:	FB CONV BOND
CASH EQUIV.:	90 DAY T-BILLS	BONDS:	LB AGGREGATE
MORTGAGES:	CITI MORTGAGE	REAL ESTATE:	NCREIF PROPERTY
INTL COMMON STK:	MS EAFE NET	INT'L BONDS:	ML WORLD BOND
STABLE VAL ASTS:	5YR GIC ROR	MISC:	SSR TOWER FUND
PRIVATE INVEST:	NASDAQ COMP	CASH:	SSR TOWER FUND

VERMONT MUNICIPAL EMPLOYEES

ALLOCATION INDEX DETAIL

ACCOUNT: R2W0208 SEIX CORE

EFFECTIVE DATE: 06/ 00

COMMON STOCK:	S&P 500	CONVERTIBLES:	FB CONV BOND
CASH EQUIV.:	90 DAY T-BILLS	BONDS:	LB AGGREGATE
MORTGAGES:	CITI MORTGAGE	REAL ESTATE:	NCREIF CL PROP
INTL COMMON STK:	MS EAFE NET	INT'L BONDS:	ML WORLD BOND
STABLE VAL ASTS:	5YR GIC ROR	MISC:	SEIX CORE
PRIVATE INVEST:	NASDAQ COMP	CASH:	SEIX CORE

ACCOUNT: R2W0211 SEIX HIGH YIELD

EFFECTIVE DATE: 06/ 03

COMMON STOCK:	S&P 500	CONVERTIBLES:	FB CONV BOND
CASH EQUIV.:	90 DAY T-BILLS	BONDS:	CITI BB&B ALL
MORTGAGES:	CITI MORTGAGE	REAL ESTATE:	NCREIF CL PROP
INTL COMMON STK:	MS EAFE NET	INT'L BONDS:	ML WORLD BOND
STABLE VAL ASTS:	5YR GIC ROR	MISC:	SEIX HIGH YIELD
PRIVATE INVEST:	NASDAQ COMP	CASH:	SEIX HIGH YIELD

ACCOUNT: R2W0209 ALTERNATIVE INVESTMENTS

EFFECTIVE DATE: 06/ 00

COMMON STOCK:	S&P 500	CONVERTIBLES:	FB CONV BOND
CASH EQUIV.:	90 DAY T-BILLS	BONDS:	LB AGGREGATE
MORTGAGES:	CITI MORTGAGE	REAL ESTATE:	NCREIF CL PROP
INTL COMMON STK:	MS EAFE NET	INT'L BONDS:	ML WORLD BOND
STABLE VAL ASTS:	5YR GIC ROR	MISC:	ALT. ASSETS
PRIVATE INVEST:	NASDAQ COMP	CASH:	ALT. ASSETS

VERMONT MUNICIPAL EMPLOYEES

ALLOCATION INDEX DETAIL

ACCOUNT: R2W0210

VERMONT INVESTMENTS

EFFECTIVE DATE: 03/01

COMMON STOCK:	S&P 500	CONVERTIBLES:	FB CONV BOND
CASH EQUIV.:	90 DAY T-BILLS	BONDS:	LB AGGREGATE
MORTGAGES:	CITI MORTGAGE	REAL ESTATE:	NCREIF CL PROP
INTL COMMON STK:	MS EAFE NET	INT'L BONDS:	ML WORLD BOND
STABLE VAL ASTS:	5YR GIC ROR	MISC:	VERMONT INVEST
PRIVATE INVEST:	NASDAQ COMP	CASH:	VERMONT INVEST

VERMONT MUNICIPAL EMPLOYEES
COMMON STOCK HOLDINGS
AS OF 3/05

DELAWARE

<u>COMPANY NAME</u>	<u>SHARES</u>	<u>PRICE</u>	<u>PORT WT</u>	<u>MKT CAP</u>	<u>DIV YLD</u>	<u>P/E</u>	<u>P/B</u>	<u>QUARTER RETURN</u>
CONSUMER DISCRETIONARY STOCK								
GENERAL MTRS CORP COM	19400	29.39	1.4	16.61	6.8	5.9	0.6	-25.6
KNIGHT RIDDER INC COM	9500	67.25	1.6	5.13	2.1	16.1	3.5	1.0
NEW YORK TIMES CO CL A COM	10800	36.58	1.0	5.34	1.7	18.5	3.8	-10.0
NIKE INC	6600	83.31	1.4	22.00	1.2	18.8	4.1	-7.9
VIACOM INC	19400	34.83	1.7	57.31	0.8	N/A	1.4	-4.1
WESTWOOD ONE INC	16700	20.35	0.8	1.93	0.0	20.8	2.5	-24.4
			<u>7.8</u>	<u>20.94</u>	<u>2.2</u>	<u>15.4</u>	<u>2.6</u>	<u>-10.5</u>
CONSUMER STAPLES STOCK								
ANHEUSER BUSCH COS INC COM	14500	47.39	1.7	37.20	2.1	16.9	13.9	-6.1
CLOROX CO COM	6800	62.99	1.1	9.66	1.8	23.7	N/A	7.4
GENERAL MILLS INC COM	12500	49.15	1.5	17.89	2.5	17.3	3.4	-0.5
PEPSICO INC COM	13800	53.03	1.8	89.04	1.7	21.6	6.6	2.0
PROCTER & GAMBLE CO COM	13900	53.00	1.8	133.70	1.9	19.9	6.8	-3.4
WAL MART STORES INC COM	10000	50.11	1.2	212.17	1.2	20.8	4.3	-4.9
			<u>9.1</u>	<u>83.97</u>	<u>1.9</u>	<u>19.8</u>	<u>7.2</u>	<u>-1.3</u>
ENERGY RELATED STOCK								
CHEVRONTEXACO CORP	13800	58.31	2.0	122.87	2.7	9.5	2.7	11.8
EXXON MOBIL CORP	18984	59.60	2.8	381.50	1.8	15.2	3.7	16.8
KERR MCGEE CORP COM	8000	78.33	1.5	11.90	2.3	23.8	2.2	36.3
MARATHON OIL CORP	14000	46.92	1.6	16.27	2.4	12.5	2.0	25.6
MURPHY OIL CORP COM	5000	98.73	1.2	9.09	0.9	18.3	3.4	23.0
			<u>9.1</u>	<u>148.83</u>	<u>2.1</u>	<u>15.4</u>	<u>2.9</u>	<u>21.4</u>

VERMONT MUNICIPAL EMPLOYEES
COMMON STOCK HOLDINGS
AS OF 3/05

DELAWARE

<u>COMPANY NAME</u>	<u>SHARES</u>	<u>PRICE</u>	<u>PORT WT</u>	<u>MKT CAP</u>	<u>DIV YLD</u>	<u>P/E</u>	<u>P/B</u>	<u>QUARTER RETURN</u>
FINANCIAL STOCK								
AMERICAN EXPRESS CO	7600	51.37	1.0	64.16	0.9	18.4	4.0	-8.5
AON CORP	18400	22.84	1.0	7.23	2.6	12.7	1.4	-3.6
BANK OF AMERICA CORP	23238	44.10	2.5	178.45	4.1	11.7	1.8	-5.2
CITIGROUP INC	35600	44.94	3.9	233.45	3.9	13.5	2.2	-5.9
J P MORGAN CHASE & CO	43596	34.60	3.7	123.04	3.9	21.8	1.2	-10.5
MBNA CORP	45900	24.55	2.8	31.37	2.3	11.8	2.4	-12.4
MELLON FINL CORP	30500	28.54	2.1	12.08	2.5	14.9	2.9	-7.7
MERRILL LYNCH & CO INC COM	10400	56.60	1.4	52.68	1.1	11.8	1.7	-5.1
MORGAN STANLEY	26500	57.25	3.7	63.16	1.9	13.7	2.2	3.6
PMI GROUP INC	15300	38.01	1.4	3.57	0.5	9.9	1.1	-8.9
PRUDENTIAL FINL INC	14100	57.40	2.0	30.38	1.1	16.3	1.4	4.4
US BANCORP DEL	33895	28.82	2.4	53.54	4.2	13.0	2.7	-7.0
			<u>28.1</u>	<u>89.44</u>	<u>2.7</u>	<u>14.4</u>	<u>2.0</u>	<u>-5.4</u>
HEALTH CARE STOCK								
ABBOTT LABS	9300	46.62	1.1	72.73	2.2	23.0	5.1	0.5
CIGNA CORP COM USD1	7600	89.30	1.7	11.79	0.1	7.7	2.3	9.5
GLAXO SMITHKLINE PLC	19800	45.92	2.3	130.72	3.3	16.0	11.5	-2.2
PFIZER INC	39600	26.27	2.6	196.32	2.9	17.4	2.9	-1.6
TENET HEALTHCARE CORP	65000	11.53	1.8	5.39	0.0	N/A	3.1	5.0
WYETH	23600	42.18	2.4	56.31	2.2	45.4	5.7	-0.4
			<u>11.8</u>	<u>88.01</u>	<u>1.9</u>	<u>22.9</u>	<u>5.3</u>	<u>1.3</u>
INDUSTRIALS STOCK								
ARAMARK CORP	17300	26.28	1.1	4.86	0.8	18.4	4.0	-0.7

VERMONT MUNICIPAL EMPLOYEES
COMMON STOCK HOLDINGS
AS OF 3/05

DELAWARE

<u>COMPANY NAME</u>	<u>SHARES</u>	<u>PRICE</u>	<u>PORT WT</u>	<u>MKT CAP</u>	<u>DIV YLD</u>	<u>P/E</u>	<u>P/B</u>	<u>QUARTER RETURN</u>
AVERY DENNISON CORP	6900	61.93	1.0	6.20	2.5	22.1	4.0	3.9
CATERPILLAR INC	4900	91.44	1.1	31.36	1.8	15.4	4.2	-5.8
EMERSON ELEC CO COM	6000	64.93	1.0	27.24	2.6	20.7	3.6	-6.8
GENERAL ELEC CO COM	46200	36.06	4.1	381.74	2.4	22.5	3.5	-0.6
GOODRICH CORP	13800	38.29	1.3	4.56	2.1	29.0	3.4	17.9
HONEYWELL INTL INC	10800	37.21	1.0	31.63	2.2	25.0	2.8	5.6
PITNEY BOWES	9600	45.12	1.1	10.39	2.7	21.7	8.1	-1.9
			<u>11.7</u>	<u>144.69</u>	<u>2.2</u>	<u>22.1</u>	<u>4.0</u>	<u>1.3</u>
INFORMATION TECHNOLOGY STOCK								
CISCO SYS INC	46700	17.89	2.1	115.94	0.0	22.1	4.9	-7.4
INTEL CORP COM	33500	23.23	1.9	145.26	1.4	19.9	3.8	-0.3
NATIONAL SEMICONDUCTOR COR	42200	20.61	2.1	7.19	0.4	19.4	4.0	14.9
ORACLE CORP COM	31300	12.48	1.0	64.10	0.0	22.7	6.5	-9.0
			<u>7.1</u>	<u>83.90</u>	<u>0.5</u>	<u>20.8</u>	<u>4.5</u>	<u>1.1</u>
MATERIALS STOCK								
DOW CHEM CO COM	20100	49.85	2.5	47.50	2.7	16.7	3.9	1.4
DU PONT E I DE NEMOURS & C	16200	51.24	2.0	50.95	2.7	28.8	4.6	5.2
INTERNATIONAL PAPER CO COM	16224	36.79	1.5	17.93	2.7	37.5	2.2	-11.8
			<u>6.0</u>	<u>41.43</u>	<u>2.7</u>	<u>25.9</u>	<u>3.7</u>	<u>-0.6</u>
TELECOMMUNICATIONS SERVICES STOCK								
ALLTEL CORP COM	15900	54.85	2.2	16.58	2.8	16.4	2.3	-6.0
BCE INC	35900	24.99	2.2	23.14	4.4	19.4	2.3	4.7
			<u>4.4</u>	<u>19.91</u>	<u>3.6</u>	<u>17.9</u>	<u>2.3</u>	<u>-0.6</u>

VERMONT MUNICIPAL EMPLOYEES
COMMON STOCK HOLDINGS
AS OF 3/05

DELAWARE

<u>COMPANY NAME</u>	<u>SHARES</u>	<u>PRICE</u>	<u>PORT WT</u>	<u>MKT CAP</u>	<u>DIV YLD</u>	<u>P/E</u>	<u>P/B</u>	<u>QUARTER RETURN</u>
UTILITIES STOCK								
DOMINION RES INC VA NEW	6100	74.43	1.1	25.31	3.6	19.4	2.2	10.9
EXELON CORP	7800	45.89	0.9	30.48	3.5	16.4	3.2	5.1
FPL GROUP INC COM	11400	40.15	1.1	14.95	3.5	16.2	2.0	8.4
			3.1	23.03	3.5	17.4	2.4	8.4

VERMONT MUNICIPAL EMPLOYEES
COMMON STOCK HOLDINGS
AS OF 3/05

ALLIANCE LARGE CAP GROWTH FUND

<u>COMPANY NAME</u>	<u>SHARES</u>	<u>PRICE</u>	<u>PORT WT</u>	<u>MKT CAP</u>	<u>DIV YLD</u>	<u>P/E</u>	<u>P/B</u>	<u>QUARTER RETURN</u>
CONSUMER DISCRETIONARY STOCK								
CARNIVAL CORP	10171	51.81	1.5	41.66	1.2	20.8	2.6	-9.9
DREAMWORKS ANIMATION SKG I	4666	40.71	0.5	4.28	0.0	9.4	5.2	8.5
EBAY INC	17823	37.26	1.9	49.88	0.0	63.2	7.4	-35.9
LENNAR CORP COM	4596	56.68	0.7	8.86	1.0	8.8	2.2	0.2
LOWES COS INC COM	24005	57.09	3.8	44.19	0.3	20.4	3.8	-0.8
PULTE HOMES INC	3803	73.63	0.8	9.42	0.3	9.3	2.1	15.5
SCRIPPS E W CO NEW	15630	48.75	2.1	7.96	0.8	26.1	3.8	1.2
STARBUCKS CORP	8818	51.66	1.3	20.81	0.0	48.3	7.4	-17.2
TARGET CORP	13321	50.02	1.9	44.55	0.6	23.9	3.4	-3.5
TIME WARNER INC NEW	34084	17.55	1.7	80.53	0.0	25.1	1.3	-9.8
			<u>16.2</u>	<u>37.20</u>	<u>0.4</u>	<u>27.8</u>	<u>4.0</u>	<u>-6.8</u>
CONSUMER STAPLES STOCK								
AVON PRODS INC COM	21743	42.94	2.6	20.25	1.3	24.0	N/ M	11.4
PROCTER & GAMBLE CO COM	11011	53.00	1.6	133.70	1.9	19.9	6.8	-3.4
WAL MART STORES INC COM	3523	50.11	0.5	212.17	1.2	20.8	4.3	-4.9
WHOLE FOODS MKT INC	4036	102.13	1.2	6.57	0.7	43.8	6.1	7.3
			<u>5.9</u>	<u>65.10</u>	<u>1.3</u>	<u>26.5</u>	<u>6.2</u>	<u>5.1</u>
ENERGY RELATED STOCK								
BAKER HUGHES INC COM	8328	44.49	1.0	14.98	1.0	28.2	3.8	4.5
HALLIBURTON CO COM	16004	43.25	1.9	19.12	1.2	49.1	4.9	10.5
NABORS INDUSTRIES LTD	13391	59.14	2.2	8.86	0.0	29.1	3.0	15.3
			<u>5.2</u>	<u>13.91</u>	<u>0.6</u>	<u>36.4</u>	<u>3.9</u>	<u>11.4</u>

VERMONT MUNICIPAL EMPLOYEES
COMMON STOCK HOLDINGS
AS OF 3/05

ALLIANCE LARGE CAP GROWTH FUND

<u>COMPANY NAME</u>	<u>SHARES</u>	<u>PRICE</u>	<u>PORT WT</u>	<u>MKT CAP</u>	<u>DIV YLD</u>	<u>P/E</u>	<u>P/B</u>	<u>QUARTER RETURN</u>
FINANCIAL STOCK								
AFLAC INC	6066	37.26	0.6	18.76	1.2	14.6	2.5	-6.2
AMERICAN INTL GROUP INC CO	15864	55.41	2.5	144.37	0.9	13.0	1.7	-15.5
CITIGROUP INC	18850	44.94	2.4	233.45	3.9	13.5	2.2	-5.9
FRANKLIN RES INC COM	5832	68.65	1.1	17.14	0.6	22.1	3.2	1.7
J P MORGAN CHASE & CO	21696	34.60	2.1	123.04	3.9	21.8	1.2	-10.5
LEGG MASON INC	3709	78.14	0.8	8.50	0.8	20.8	3.9	6.9
MBNA CORP	33127	24.55	2.3	31.37	2.3	11.8	2.4	-12.4
MERRILL LYNCH & CO INC COM	3173	56.60	0.5	52.68	1.1	11.8	1.7	-5.1
SCHWAB CHARLES CORP NEW	38749	10.51	1.1	13.99	0.8	33.9	3.2	-12.0
			<u>13.4</u>	<u>98.32</u>	<u>2.1</u>	<u>17.3</u>	<u>2.2</u>	<u>-8.6</u>
HEALTH CARE STOCK								
ALCON INC	8842	89.29	2.2	27.29	0.6	31.3	12.5	10.8
AMGEN INC COM	18477	58.21	3.0	73.34	0.0	31.3	3.7	-9.3
BOSTON SCIENTIFIC CORP	28298	29.29	2.3	24.47	0.0	23.1	6.1	-17.6
GILEAD SCIENCES INC	5622	35.80	0.6	16.07	0.0	34.4	8.6	2.3
PFIZER INC	15607	26.27	1.1	196.32	2.9	17.4	2.9	-1.6
ST JUDE MED INC COM	20604	36.00	2.1	12.92	0.0	31.0	5.5	-14.1
TEVA PHARMACEUTICAL INDS L	16424	30.99	1.4	18.95	0.7	57.4	3.5	4.0
UNITEDHEALTH GROUP INC	7115	95.38	1.9	61.33	0.0	23.1	5.7	8.4
WELLPOINT INC	2356	125.35	0.8	37.93	0.0	19.9	1.9	9.0
ZIMMER HLDGS INC	4782	77.81	1.0	19.10	0.0	35.0	4.8	-2.9
			<u>16.5</u>	<u>48.05</u>	<u>0.3</u>	<u>30.2</u>	<u>5.8</u>	<u>-2.9</u>
INDUSTRIALS STOCK								
GENERAL ELEC CO COM	27388	36.06	2.8	381.74	2.4	22.5	3.5	-0.6

VERMONT MUNICIPAL EMPLOYEES
COMMON STOCK HOLDINGS
AS OF 3/05

ALLIANCE LARGE CAP GROWTH FUND

<u>COMPANY NAME</u>	<u>SHARES</u>	<u>PRICE</u>	<u>PORT WT</u>	<u>MKT CAP</u>	<u>DIV YLD</u>	<u>P/E</u>	<u>P/B</u>	<u>QUARTER RETURN</u>
TYCO INTL LTD NEW	11198	33.80	1.1	68.02	1.2	22.4	2.1	- 5.2
UNITED PARCEL SVC INC	4946	72.74	1.0	81.91	1.8	24.7	5.0	- 14.5
			<u>4.8</u>	<u>250.44</u>	<u>2.0</u>	<u>22.9</u>	<u>3.5</u>	<u>- 4.5</u>

INFORMATION TECHNOLOGY STOCK

ALTERA CORP COM	6742	19.78	0.4	7.39	0.0	26.7	5.8	- 4.4
APPLE COMPUTER INC COM	8165	41.67	1.0	33.72	0.0	63.1	5.8	29.4
BROADCOM CORP	21929	29.92	1.8	9.89	0.0	44.0	4.2	- 7.3
CISCO SYS INC	37606	17.89	1.9	115.94	0.0	22.1	4.9	- 7.4
CORNING INC	89630	11.13	2.8	15.67	0.0	N/ A	4.2	- 5.4
DELL INC	44932	38.42	4.8	95.47	0.0	31.8	14.7	- 8.8
ELECTRONIC ARTS INC	22676	51.78	3.3	15.89	0.0	26.8	4.8	- 16.1
GOOGLE INC	3033	180.51	1.5	49.32	0.0	87.2	N/ M	- 6.4
JUNIPER NETWORKS INC	41432	22.06	2.6	11.92	0.0	78.8	2.0	- 18.9
MARVELL TECHNOLOGY GROUP L	17637	38.34	1.9	10.48	0.0	72.3	4.2	8.1
MICROSOFT CORP	33337	24.17	2.3	262.97	1.3	26.3	5.6	- 9.3
NETWORK APPLIANCE INC	15164	27.66	1.2	10.13	0.0	50.3	6.2	- 16.7
QUALCOMM INC	31237	36.63	3.2	60.18	0.8	32.6	5.8	- 13.4
RESEARCH IN MOTION LTD	4969	76.42	1.1	14.44	0.0	67.0	7.3	- 7.3
SAP AKTIENGESELLSCHAFT	12481	40.08	1.4	49.80	0.6	28.0	8.0	- 9.3
SYMANTEC CORP	17240	21.33	1.0	15.10	0.0	25.4	4.2	- 17.2
TAIWAN SEMICONDUCTOR MFG C	52869	8.48	1.3	39.14	1.1	15.5	4.0	- 0.1
YAHOO INC	47614	33.90	4.5	46.90	0.0	54.7	6.6	- 10.0
			<u>37.9</u>	<u>55.87</u>	<u>0.2</u>	<u>43.7</u>	<u>6.4</u>	<u>- 8.5</u>

VERMONT MUNICIPAL EMPLOYEES
COMMON STOCK HOLDINGS
AS OF 3/05

LAZARD SMALL CAP FUND

<u>COMPANY NAME</u>	<u>SHARES</u>	<u>PRICE</u>	<u>PORT WT</u>	<u>MKT CAP</u>	<u>DIV YLD</u>	<u>P/E</u>	<u>P/B</u>	<u>QUARTER RETURN</u>
CONSUMER DISCRETIONARY STOCK								
99 CENTS ONLY STORES	7567	13.17	0.4	0.92	0.0	29.9	1.9	-18.5
ADVO INC	9622	37.45	1.5	1.17	1.2	25.0	7.8	5.4
ALLIANCE GAMING CORP	12491	9.59	0.5	0.49	0.0	34.3	2.7	-30.6
ANNTAYLOR STORES CORP	8102	25.59	0.9	1.81	0.0	28.1	2.0	18.9
ARBITRON INC	7834	42.90	1.4	1.33	0.9	21.9	N/ M	9.8
CBRL GROUP INC	3801	41.30	0.7	1.98	1.2	17.0	2.3	-1.0
COST PLUS INC CALIF	3172	26.88	0.4	0.58	0.0	19.9	2.0	-16.3
CSK AUTO INC	8090	17.65	0.6	0.79	0.0	43.0	2.3	5.4
GYMBOREE CORP	10751	12.54	0.6	0.39	0.0	20.6	1.7	-2.2
HOT TOPIC INC	8719	21.85	0.8	0.99	0.0	25.4	5.3	27.1
JARDEN CORP	2263	45.88	0.4	1.30	0.0	29.6	3.9	5.6
JOURNAL REGISTER CO	12521	16.70	0.9	0.70	0.0	6.0	4.1	-13.6
K-SWISS INC	4615	33.03	0.6	1.14	0.3	16.2	5.0	13.5
LEAPFROG ENTERPRISES INC	469	11.35	0.0	0.69	0.0	N/ A	1.6	-16.5
LIBERTY CORP COM	5530	40.55	0.9	0.75	2.5	19.4	1.9	1.9
PROQUEST CO	5334	36.15	0.8	1.04	0.0	19.5	3.9	21.7
R H DONNELLEY CORP	4110	58.09	1.0	1.83	0.0	37.5	N/ M	-1.6
SPORTS AUTHORITY INC	7341	27.50	0.8	0.71	0.0	20.7	1.5	6.8
TBC CORP NEW	6635	27.86	0.8	0.62	0.0	16.4	2.0	0.2
TIMBERLAND CO	3053	70.93	0.9	2.42	0.0	16.2	4.7	13.2
TRACTOR SUPPLY CO	5286	43.65	1.0	1.67	0.0	26.0	4.5	17.3
WARNACO GROUP INC	9854	24.04	1.0	1.10	0.0	23.3	1.9	11.3
WINNEBAGO INDS INC	3213	31.60	0.4	1.06	0.9	15.1	4.6	-18.9
			17.4	1.19	0.4	23.0	3.6	5.0
CONSUMER STAPLES STOCK								
DELTA & PINE LD CO	8583	27.00	1.0	1.06	1.8	60.0	4.6	-0.6

VERMONT MUNICIPAL EMPLOYEES
COMMON STOCK HOLDINGS
AS OF 3/05

LAZARD SMALL CAP FUND

<u>COMPANY NAME</u>	<u>SHARES</u>	<u>PRICE</u>	<u>PORT WT</u>	<u>MKT CAP</u>	<u>DIV YLD</u>	<u>P/E</u>	<u>P/B</u>	<u>QUARTER RETURN</u>
PERFORMANCE FOOD GROUP CO	5791	27.68	0.7	1.29	0.0	24.5	1.5	2.9
			1.7	1.15	1.1	45.5	3.3	0.8
ENERGY RELATED STOCK								
BILL BARRETT CORP	1758	28.91	0.2	1.25	0.0	N/A	2.0	-9.6
DENBURY RES INC DEL	4865	35.23	0.7	1.99	0.0	23.5	3.7	28.3
ENERGY PARTNERS LTD	5969	25.97	0.7	0.86	0.0	19.8	3.1	28.1
FOREST OIL CORP	4086	40.50	0.7	2.42	0.0	18.8	1.6	27.7
GREY WOLF INC	24810	6.58	0.7	1.25	0.0	N/M	5.3	24.9
HANOVER COMPRESSOR CO	12313	12.07	0.6	1.05	0.0	N/A	1.4	-14.6
HOUSTON EXPL CO	2934	56.95	0.7	1.62	0.0	10.4	2.1	1.1
KEY ENERGY GROUP INC	30880	11.47	1.5	1.49	0.0	95.6	2.0	-2.8
KINDER MORGAN MGMT LLC	5232	40.59	0.9	2.20	0.0	27.6	1.4	-0.3
MAVERICK TUBE CORP	3362	32.51	0.5	1.39	0.0	7.1	2.3	7.3
OMI CORP NEW	9711	19.15	0.8	1.64	1.3	6.7	2.1	14.1
RANGE RES CORP	8078	23.36	0.8	1.86	0.3	39.6	3.3	14.3
VERITAS DOC INC	7728	29.96	1.0	1.00	0.0	N/A	2.1	33.7
WHITING PETE CORP NEW	4354	40.78	0.7	1.21	N/A	12.1	2.0	34.8
			10.4	1.54	0.1	33.5	2.4	13.9
FINANCIAL STOCK								
ALEXANDRIA REAL ESTATE EQ	1711	64.38	0.5	1.26	4.1	28.2	2.9	-12.6
ARCH CAPITAL GROUP LTD	6355	40.04	1.1	1.40	0.0	4.0	0.6	3.5
ASSURED GUARANTY LTD COM	13091	17.95	1.0	1.35	0.7	7.4	0.9	-8.6
BANK OF THE OZARKS INC	505	31.75	0.1	0.52	1.0	20.1	4.3	-6.5
BRISTOL WEST HLDGS INC	1823	15.50	0.1	0.49	1.3	7.8	1.5	-22.3
CALAMOS ASSET MGMT INC CL	5352	26.92	0.6	0.62	1.0	5.8	7.3	0.0

VERMONT MUNICIPAL EMPLOYEES
COMMON STOCK HOLDINGS
AS OF 3/05

LAZARD SMALL CAP FUND

<u>COMPANY NAME</u>	<u>SHARES</u>	<u>PRICE</u>	<u>PORT WT</u>	<u>MKT CAP</u>	<u>DIV YLD</u>	<u>P/E</u>	<u>P/B</u>	<u>QUARTER RETURN</u>
CAPITAL AUTOMOTIVE REIT	2429	33.12	0.3	1.44	5.2	24.7	1.5	-5.5
CARRAMERICA REALTY CORP	3991	31.55	0.5	1.73	6.3	31.9	2.4	-2.9
ESPEED INC CL A	19334	9.20	0.7	0.49	0.0	19.6	1.8	-25.6
FINANCIAL FEDERAL CORP	3700	35.37	0.5	0.62	1.1	17.8	1.9	-9.3
FIRST CMNTY BANCORP CALIF	3837	44.30	0.7	0.72	2.0	18.9	1.9	4.3
FIRST MIDWEST BANCORP INC	4906	32.48	0.7	1.50	3.0	15.2	2.8	-9.8
FIRST REP BK SAN FRANCISCO	2988	32.37	0.4	0.80	1.2	17.7	2.1	-8.1
HUDSON UNITED BANCORP	1936	35.25	0.3	1.59	4.2	12.3	3.0	-9.6
INDYMAC MTG HLDGS INC	3279	34.00	0.5	2.11	4.2	11.8	1.7	-0.4
INLAND REAL ESTATE CORP CO	3504	15.03	0.2	1.01	6.4	23.9	2.2	-5.3
KNIGHT TRADING GROUP INC	22600	9.64	0.9	1.09	0.0	N/A	1.3	-12.0
LEXINGTON CORPORATE PPTYS	5126	21.94	0.5	1.07	6.6	27.8	1.7	-1.2
MAF BANCORP INC	4847	41.54	0.8	1.38	2.2	13.4	1.4	-6.8
MAX RE CAPITAL	7739	23.53	0.8	1.06	0.5	7.1	1.3	10.6
MB FINANCIAL INC	1627	38.30	0.3	1.10	1.4	16.6	2.3	-8.8
MILLS CORP	3433	52.90	0.8	2.90	4.5	16.0	5.9	-16.2
PRENTISS PPTYS TR	1966	34.16	0.3	1.54	6.6	35.6	1.8	-9.1
PROVIDENT BANKSHARES CORP	3944	32.96	0.5	1.09	3.2	16.6	1.8	-8.6
REINSURANCE GROUP AMER INC	1657	42.58	0.3	2.66	0.8	10.8	1.2	-11.9
SOUTH FINL GROUP INC	6605	30.54	0.8	2.18	2.1	16.5	1.6	-5.6
STERLING BANCSHARES INC	16572	14.20	1.0	0.64	1.7	25.4	2.0	-0.1
TEXAS REGL BANCSHARES INC	3683	30.11	0.5	1.49	1.3	18.8	2.5	-7.5
UMPQUA HLDGS CORP	5120	23.35	0.5	1.03	1.0	19.3	1.5	-7.1
UNITED BANKSHARES INC	6213	33.14	0.9	1.43	3.1	17.3	2.3	-12.5
W HLDG CO INC	6283	10.07	0.3	1.65	1.9	11.3	1.6	-33.9
WESTAMERICA BANCORPORATION	4294	51.77	0.9	1.64	2.3	17.3	4.6	-10.7
			<u>18.3</u>	<u>1.32</u>	<u>2.2</u>	<u>16.5</u>	<u>2.3</u>	<u>-7.1</u>
HEALTH CARE STOCK								
ABLE LABORATORIES INC	7110	23.46	0.7	0.43	0.0	27.9	4.5	3.1

VERMONT MUNICIPAL EMPLOYEES
COMMON STOCK HOLDINGS
AS OF 3/05

LAZARD SMALL CAP FUND

<u>COMPANY NAME</u>	<u>SHARES</u>	<u>PRICE</u>	<u>PORT WT</u>	<u>MKT CAP</u>	<u>DIV YLD</u>	<u>P/E</u>	<u>P/B</u>	<u>QUARTER RETURN</u>
ANDRX CORP DEL	8892	22.67	0.8	1.65	0.0	25.2	2.4	3.8
BEVERLY ENTERPRISES INC	27738	12.38	1.4	1.34	0.0	30.9	4.9	35.3
BIO RAD LABS INC CL A	184	48.71	0.0	1.26	0.0	18.9	2.1	-15.1
CHARLES RIVER LABORATORIES	1532	47.04	0.3	3.09	0.0	26.0	2.1	2.2
CUTERA INC COM	2168	19.28	0.2	0.21	0.0	50.7	3.0	54.2
DJ ORTHOPEDICS INC	9901	25.05	1.0	0.54	0.0	38.0	2.9	16.9
HANGER ORTHOPEDIC CORP	2916	5.95	0.1	0.13	0.0	N/A	0.8	-26.5
INAMED CORP	3136	69.88	0.9	2.51	0.0	39.5	5.6	10.5
KINDRED HEALTHCARE INC	9218	35.10	1.4	1.31	0.0	14.6	1.8	17.2
LIFEPOINT HOSPS INC	7335	43.84	1.4	1.71	0.0	18.7	3.3	25.9
MARTEK BIOSCIENCES CORP	2025	58.19	0.5	1.82	0.0	33.6	4.2	13.7
PSS WORLD MED INC	15491	11.37	0.7	0.73	0.0	20.3	2.8	-9.1
RESPIRONICS INC	214	58.27	0.1	2.06	0.0	27.9	3.6	7.2
TARO PHARMACEUTICAL INDS L	4811	31.56	0.6	0.91	0.0	83.1	2.6	-7.3
VIASYS HEALTHCARE INC	998	19.08	0.1	0.59	0.0	38.9	1.3	0.4
			10.3	1.35		30.8	3.4	14.2

INDUSTRIALS STOCK

AIRTRAN HLDGS INC	16304	9.05	0.6	0.78	0.0	64.6	2.3	-15.4
CHICAGO BRDG & IRON CO N V	4989	44.03	0.9	2.13	0.5	31.9	4.5	10.2
CORINTHIAN COLLEGES INC	9622	15.72	0.6	1.42	0.0	17.9	3.6	-16.6
DEVRY INC DEL	7413	18.92	0.6	1.33	0.0	33.2	2.7	9.0
DRS TECHNOLOGIES INC	6635	42.50	1.2	1.16	0.0	19.7	1.8	-0.5
ESTERLINE CORP	3516	34.55	0.5	0.87	0.0	18.3	1.5	5.8
FORWARD AIR CORP	4075	42.58	0.7	0.92	0.6	26.6	5.1	-4.5
GENERAL CABLE CORP DEL NEW	2845	12.07	0.1	0.47	0.0	52.5	3.2	-12.9
GRAFTECH INTL LTD	13727	5.69	0.3	0.56	0.0	31.6	N/A	-39.9
LEARNING TREE INTERNATIONA	14012	14.41	0.8	0.24	0.0	N/M	3.4	7.5

VERMONT MUNICIPAL EMPLOYEES
COMMON STOCK HOLDINGS
AS OF 3/05

LAZARD SMALL CAP FUND

<u>COMPANY NAME</u>	<u>SHARES</u>	<u>PRICE</u>	<u>PORT WT</u>	<u>MKT CAP</u>	<u>DIV YLD</u>	<u>P/E</u>	<u>P/B</u>	<u>QUARTER RETURN</u>
MILLER HERMAN INC COM	7603	30.12	1.0	2.11	1.0	32.0	12.0	9.3
OVERNITE CORP	4354	31.99	0.6	0.90	0.5	14.0	2.2	-14.0
PACER INTL INC TENN	13204	23.89	1.3	0.89	0.0	18.8	3.4	12.4
ROPER INDS INC	3991	65.50	1.1	2.78	0.6	26.0	2.5	8.0
SHAW GROUP INC	11416	21.80	1.0	1.40	0.0	33.5	1.6	22.1
SWIFT TRANSN INC	6237	22.14	0.6	1.59	0.0	17.0	2.2	3.1
TECUMSEH PRODUCTS CO	5209	39.61	0.9	0.73	3.2	72.0	0.7	-16.5
TETRA TECH INC NEW	16132	12.62	0.9	0.71	0.0	38.2	1.7	-24.6
UNITED RENTALS INC	5946	20.21	0.5	1.57	0.0	N/A	1.5	6.9
WASTE CONNECTIONS INC	3861	34.75	0.6	1.65	0.0	22.3	2.3	1.5
WATSON WYATT & CO HLDGS	8215	27.20	0.9	0.89	1.1	17.3	3.2	1.2
			15.8	1.27	0.4	29.8	3.2	0.4

INFORMATION TECHNOLOGY STOCK

ADVANCED DIGITAL INFORMATI	15503	8.14	0.5	0.52	0.0	N/M	1.4	-18.8
AMIS HLDGS INC	11380	11.29	0.5	0.96	0.0	17.9	3.3	-31.7
AVOCENT CORP	3255	25.66	0.4	1.29	0.0	69.4	1.8	-36.8
BEARINGPOINT INC	13536	8.77	0.5	1.75	0.0	N/A	1.5	9.2
BENCHMARK ELECTRS INC	4882	31.83	0.7	1.32	0.0	18.4	1.8	-6.7
BISYS GROUP INC	9034	15.68	0.6	1.88	0.0	23.4	2.3	-4.7
BLACK BOX CORP DEL	362	37.41	0.1	0.65	0.6	16.0	1.3	-22.0
BROOKS AUTOMATION INC NEW	7929	15.18	0.5	0.68	0.0	26.2	2.1	-11.8
C-CORNET CORP	27887	6.08	0.7	0.26	0.0	33.8	1.2	-34.6
CATAPULT COMMUNICATIONS CO	1437	21.35	0.1	0.31	0.0	17.1	2.6	-11.6
COHERENT INC COM	6747	33.76	1.0	1.03	0.0	44.4	1.7	10.9
COMMSCOPE INC	11363	14.96	0.7	0.82	0.0	11.3	1.8	-20.8
DITECH COMMUNICATIONS CORP	5827	12.47	0.3	0.40	0.0	5.9	2.0	-16.6
EXAR CORP	18045	13.40	1.0	0.57	0.0	58.3	1.2	-5.6

VERMONT MUNICIPAL EMPLOYEES
COMMON STOCK HOLDINGS
AS OF 3/05

LAZARD SMALL CAP FUND

<u>COMPANY NAME</u>	<u>SHARES</u>	<u>PRICE</u>	<u>PORT WT</u>	<u>MKT CAP</u>	<u>DIV YLD</u>	<u>P/E</u>	<u>P/B</u>	<u>QUARTER RETURN</u>
FOUNDRY NETWORKS INC	12343	9.90	0.5	1.36	0.0	28.3	1.9	-24.8
JDA SOFTWARE GROUP INC	7603	14.04	0.4	0.41	0.0	N/ M	1.5	3.1
KOMAG INC	13251	22.35	1.2	0.63	0.0	11.9	2.2	19.0
METROLOGIC INSTRS INC	8036	22.48	0.8	0.49	0.0	21.2	3.5	5.8
MPS GROUP INC	17944	10.51	0.8	1.09	0.0	30.9	1.3	-14.3
OPLINK COMMUNICATIONS INC	24780	1.57	0.2	0.23	0.0	N/ A	1.1	-20.3
PHOTON DYNAMICS INC	8114	19.06	0.6	0.32	0.0	26.8	2.0	-21.3
PLEXUS CORP	10739	11.51	0.5	0.50	0.0	N/ A	1.4	-11.5
ROGERS CORP COM	4835	40.00	0.8	0.66	0.0	16.3	2.3	-7.2
SERENA SOFTWARE INC	11838	23.76	1.2	1.01	0.0	103.3	3.4	9.9
TITAN CORP COM	13335	18.16	1.0	1.53	0.0	113.5	4.4	12.1
TTM TECHNOLOGIES INC	21620	10.46	0.9	0.43	0.0	15.2	2.0	-11.4
ULTRATECH INC	5304	14.60	0.3	0.34	0.0	N/ M	1.8	-22.5
VERITY INC	12901	9.45	0.5	0.36	0.0	39.4	1.2	-28.0
			<u>17.4</u>	<u>0.82</u>	<u>0.0</u>	<u>39.1</u>	<u>2.1</u>	<u>-7.1</u>

MATERIALS STOCK

FERRO CORP COM	4841	18.82	0.4	0.79	3.1	38.4	1.5	-18.2
FOUNDATION COAL HLDGS INC	7454	23.51	0.7	0.46	0.0	N/ A	2.2	2.1
OLIN CORP COM	10115	22.30	0.9	1.57	3.6	30.1	4.4	2.1
PACKAGING CORP AMER	5393	24.29	0.6	2.60	4.1	37.4	3.2	4.2
POLYONE CORPORATION-W/	17338	8.88	0.6	0.81	0.0	44.4	2.1	-2.0
SCHNITZER STEEL INDS INC	2251	33.73	0.3	1.03	0.2	6.4	2.2	-0.5
SCOTTS MIRACLE GRO CO	2928	70.23	0.9	2.33	0.0	20.7	2.8	-4.5
SPARTECH CORP	7347	19.85	0.6	0.64	2.4	17.3	1.5	-26.3
STEEL DYNAMICS INC	2002	34.45	0.3	1.67	1.2	5.8	2.0	-8.8
			<u>5.4</u>	<u>1.37</u>	<u>1.6</u>	<u>27.0</u>	<u>2.6</u>	<u>-4.7</u>

VERMONT MUNICIPAL EMPLOYEES
COMMON STOCK HOLDINGS
AS OF 3/05

LAZARD SMALL CAP FUND

<u>COMPANY NAME</u>	<u>SHARES</u>	<u>PRICE</u>	<u>PORT WT</u>	<u>MKT CAP</u>	<u>DIV YLD</u>	<u>P/E</u>	<u>P/B</u>	<u>QUARTER RETURN</u>
TELECOMMUNICATIONS SERVICES STOCK								
WIRELESS FACS INC	13614	6.25	0.4	0.43	0.0	69.4	2.1	- 33.8
			0.4	0.43		69.4	2.1	- 33.8
UTILITIES STOCK								
AGL RES INC	5268	34.93	0.8	2.68	3.5	15.2	1.9	6.0
CLECO CORP NEW	10424	21.30	0.9	1.06	4.2	16.0	2.0	6.3
NEW JERSEY RES CORP COM	3077	43.53	0.6	1.21	3.1	15.4	2.4	1.2
			2.3	1.65	3.7	15.6	2.1	4.9

VERMONT MUNICIPAL EMPLOYEES

BOND HOLDINGS

AS OF 3/05

SEIX CORE

	<u>BOND NAME</u>	<u>MARKET VALUE</u>	<u>COUPON</u>	<u>STATED MATURITY</u>	<u>MOODY RATE</u>	<u>DUR-ATION</u>	<u>YIELD TO MATURITY</u>
0-5 YEARS	AMERICAN STANDARD INC	152,056	7.63	2/15/10	BAA3	4.07	4.97%
	BANK_ONE_2003-002A- A	398,738	2.86	10/15/08	AAA	0.04	2.90%
	BA_MTG_CC_2001-A- A	466,344	2.93	6/15/08	AAA	0.04	2.84%
	BNP US FDG 144A	133,204	7.74	12/05/07	A1	2.37	4.59%
	BRITISH SKY BROADCASTING G	129,859	6.88	2/23/09		N/A	N/A
	CITIBANK_CC_2002-A5- A5	279,421	3.05	9/15/07	AAA	-0.04	3.94%
	DEERE JOHN CAP CORP	64,892	3.90	1/15/08	A3	2.59	4.47%
	ERAC USA FIN CO 144A	137,843	7.35	6/15/08	BAA1	2.81	4.65%
	GOLDEN WEST FINL	95,396	4.13	8/15/07	A1	2.23	4.20%
	GOLDMAN SACHS GROUP	78,670	3.88	1/15/09	AA3	3.45	4.63%
	HARLEY DAVIDSON FDG MTN 14	63,068	3.63	12/15/08	A1	3.39	4.33%
	MARRIOTT INTL	28,105	7.88	9/15/09	BAA2	3.78	4.83%
	MERRILL LYNCH & CO MTN	39,850	3.70	4/21/08	AA3	2.81	4.39%
	METLIFE INC	57,063	5.25	12/01/06	A2	1.56	4.06%
	MONUMENTAL GBL FDG 144A	113,059	5.20	1/30/07	AA3	1.73	4.10%
	NCR CORP NEW	38,062	7.13	6/15/09	BAA3	3.57	5.08%
	NORTHERN STATES PWR MN	44,541	2.88	8/01/06	A2	1.29	3.96%
	PANHANDLE EASTERN PL	65,399	4.80	8/15/08	BAA3	3.07	4.78%
	PANHANDLE EASTERN PL	38,781	2.75	3/15/07	BAA3	1.87	4.46%
	PENZENERGY CO	26,953	10.25	11/01/05	BAA2	0.55	4.33%
	PRUDENTIAL FINL INC MTN	44,623	3.75	5/01/08	A3	2.83	4.47%
	PUB SVC COLO	116,492	4.38	10/01/08	A3	3.15	4.50%
	PULTE HOMES INC	90,053	4.88	7/15/09	BAA3	3.78	5.23%
	SIMON PPTY GROUP	48,172	6.38	11/15/07	BAA2	2.35	4.66%
	UNITED STATES TREAS BILL	1,091,090	0.00	7/14/05	AAA	0.29	0.00%
	UNITED STATES TREAS BONDS	1,672,485	10.75	8/15/05	GOVT	0.37	2.95%
	UNITED STATES TREAS NTS	2,334,958	3.38	2/28/07	GOVT	1.83	3.77%
	UNITED STATES TREAS NTS	8,634,718	3.13	5/15/07	GOVT	2.01	3.82%

VERMONT MUNICIPAL EMPLOYEES

BOND HOLDINGS

AS OF 3/05

SEIX CORE

	<u>BOND NAME</u>	<u>MARKET VALUE</u>	<u>COUPON</u>	<u>STATED MATURITY</u>	<u>MOODY RATE</u>	<u>DUR-ATION</u>	<u>YIELD TO MATURITY</u>
	UNITED STATES TREAS NTS	2,813,256	3.50	11/15/06	GOVT	1.55	3.70%
	UNITED STATES TREAS NTS	1,936,390	1.63	4/30/05	GOVT	0.08	2.74%
	UNITED STATES TREAS NTS	1,496,042	4.00	3/15/10	GOVT	4.44	4.18%
	UNITED STATES TREAS NTS	6,152,071	6.00	8/15/09	GOVT	3.83	4.12%
		<u>28,881,651</u>	<u>4.19</u>			<u>2.14</u>	<u>3.63%</u>
5-10 YEARS	BANK OF AMERICA	240,728	7.40	1/15/11	AA3	4.70	4.85%
	CAPITAL ONE FINL CORP	97,813	4.80	2/21/12	BAA3	5.75	5.30%
	CENTERPOINT ENERGY RES	143,817	7.88	4/01/13	BA1	5.87	5.40%
	CIT GROUP INC	166,693	5.13	9/30/14	A2	7.41	5.30%
	CITIGROUP INC	91,628	5.13	5/05/14	AA1	7.03	5.13%
	COMCAST CABLE	227,676	7.13	6/15/13	BAA3	6.17	5.41%
	CORPORACION NACIONAL DEL C	114,341	5.50	10/15/13	A2	N/A	N/A
	COX COMMUNICATIONS INC	95,092	4.63	6/01/13	BAA3	6.55	5.68%
	CREDIT SUISSE FIRST BOSTON	104,122	6.50	1/15/12	AA3	N/A	N/A
	ENERGY GULF STATES INC	123,010	4.88	11/01/11	BAA3	4.17	5.15%
	FUND AMERN COS	233,436	5.88	5/15/13	BAA2	6.28	5.64%
	GENL ELEC CO	392,782	5.00	2/01/13	AAA	6.38	5.02%
	GOLDMAN SACHS GROUP	205,046	4.75	7/15/13	AA3	6.66	5.32%
	GTECH HLDGS CORP	60,012	4.75	10/15/10	BAA1	4.70	5.12%
	HARRAHS OPER INC	65,489	5.38	12/15/13	BAA3	6.76	5.50%
	JP MORGAN CHASE	300,835	6.63	3/15/12	A1	5.59	5.02%
	LENNAR CORP	66,960	5.95	3/01/13	BAA3	6.25	5.50%
	MBNA CORP MTN	228,331	6.13	3/01/13	BAA2	6.23	5.27%
	MERRILL LYNCH & CO MTN	113,270	5.00	1/15/15	AA3	7.53	5.41%
	MORGAN STANLEY GROUP	156,238	5.30	3/01/13	AA3	6.37	5.21%
	MOTIVA ENTERPRISES LLC 144	75,511	5.20	9/15/12	A2	6.11	4.99%
	NEWS AMERICA HLDGS INC	119,778	9.25	2/01/13	BAA3	5.76	5.33%

VERMONT MUNICIPAL EMPLOYEES

BOND HOLDINGS

AS OF 3/05

SEIX CORE

	<u>BOND NAME</u>	<u>MARKET VALUE</u>	<u>COUPON</u>	<u>STATED MATURITY</u>	<u>MOODY RATE</u>	<u>DUR-ATION</u>	<u>YIELD TO MATURITY</u>
	PACKAGING CORP AMER	59,981	5.75	8/01/13	BA1	6.47	5.90%
	PRUDENTIAL FINL INC MTN	78,781	5.10	9/20/14	A3	7.39	5.23%
	TELUS CORP	112,344	8.00	6/01/11		N/A	N/A
	UNITED STATES TREAS NTS	202,810	4.00	2/15/15	GOVT	7.99	4.50%
	UNITED STATES TREAS NTS	1,591,270	3.88	2/15/13	GOVT	6.66	4.40%
	UNITED STATES TREAS NTS	378,360	4.25	11/15/14	GOVT	7.67	4.52%
	UNITED STATES TREAS NTS	467,487	4.88	2/15/12	GOVT	5.78	4.32%
	UNITED STATES TREAS NTS	4,327,248	1.88	7/15/13	GOVT	N/A	N/A
		<u>10,640,887</u>	<u>3.85</u>			<u>6.41</u>	<u>4.88%</u>
10-20 YEARS	FHLMC GOLD POOL - B10460	233,924	4.50	10/01/18	GOVT	3.49	4.50%
	FHLMC GOLD POOL - B11375	84,694	6.00	12/01/18	GOVT	2.41	5.96%
	FNMA TBA APR 15 SINGLE	2,073,509	5.00	2/28/18	GOVT	N/A	N/A
	FNMA TBA APR 15 SINGLE	868,198	4.50	3/31/18	GOVT	N/A	N/A
	FNMA POOL - 593146	113,906	6.00	8/01/16	GOVT	2.42	5.88%
	FNMA POOL - 713567	131,849	5.50	4/01/18	GOVT	2.25	5.35%
	FNMA POOL - 793044	269,443	5.00	8/01/19	GOVT	3.29	4.96%
	FNMA POOL - 793480	292,401	5.00	8/01/19	GOVT	3.29	4.96%
	FNMA POOL - 794330	175,978	5.00	9/01/19	GOVT	3.37	4.96%
	FNMA POOL - 794439	194,611	5.00	10/01/19	GOVT	3.37	4.96%
	MORG_ST_CAP_2003-001- A	180,527	3.12	11/25/15	AAA	0.08	3.06%
	SBC COMMUNICATIONS INC	15,356	5.63	6/15/16	A2	8.09	5.58%
		<u>4,634,395</u>	<u>4.87</u>			<u>2.85</u>	<u>4.84%</u>
OVER 20 YEARS	AAMES_MTG_TR_1999-002- AF	69,603	7.59	10/15/29	AAA	2.32	6.42%
	AOL TIME WARNER	205,608	7.63	4/15/31	BAA1	12.13	6.26%
	ARC 2002-BC1F A	136,983	2.11	1/25/32	AAA	N/A	N/A
	CITIGROUP INC	119,021	5.88	2/22/33	AA2	13.50	5.79%

VERMONT MUNICIPAL EMPLOYEES

BOND HOLDINGS

AS OF 3/05

SEIX CORE

<u>BOND NAME</u>	<u>MARKET VALUE</u>	<u>COUPON</u>	<u>STATED MATURITY</u>	<u>MOODY RATE</u>	<u>DUR-ATION</u>	<u>YIELD TO MATURITY</u>
COMCAST CORP NEW	28,101	7.05	3/15/33	BAA3	13.03	6.16%
CWABS_HEL_2002-B- A	284,745	3.06	4/15/28	AAA	0.04	3.09%
CWABS_HEL_2002-D- A	115,302	3.06	8/15/28	AAA	0.05	3.08%
DAIMLERCHRYSLER NA CORP	128,345	8.50	1/18/31	A3	12.17	6.79%
DELTA_FND_1999-003- A1F	9,275	7.46	9/15/29	AAA	4.43	7.41%
DEUTSCHE TELEKOM INT FIN	72,597	9.25	6/01/32	Baa1	N/A	N/A
DEVON FING CORP	81,459	7.88	9/30/31	BAA2	12.51	6.01%
DOMINION RESOURCES	67,235	6.75	12/15/32	BAA1	12.75	6.09%
ENTERPRISE PRODUCTS	84,402	6.88	3/01/33	BAA3	13.03	6.50%
EQCC_HEL_1999-003- A7F	26,904	7.45	8/25/29	AAA	1.84	7.32%
FEDERAL HOME LN MTG CORP	301,974	6.00	12/01/31	GOVT	N/A	N/A
FEDERAL NATIONAL MORTGAGE	409,573	5.50	4/01/33	GOVT	N/A	N/A
FEDERAL NATL MTG ASSN	199,282	7.00	12/01/33	GOVT	N/A	N/A
FEDERATED DEPT STORES	50,058	6.90	4/01/29	BAA1	11.87	6.32%
FHLMC TBA APR 30 GOLD SI	400,920	5.50	7/31/33	GOVT	N/A	N/A
FHLMC GOLD	1,242,187	5.00	4/01/33	GOVT	N/A	N/A
FHLMC GOLD POOL - A10098	285,132	5.50	6/01/33	GOVT	3.50	5.50%
FHLMC GOLD POOL - A11080	256,981	5.00	7/01/33	GOVT	4.48	5.01%
FHLMC GOLD POOL - A13482	43,388	6.00	9/01/33	GOVT	2.90	5.96%
FHLMC GOLD POOL - A16521	190,885	6.00	12/01/33	GOVT	2.84	5.95%
FHLMC GOLD POOL - A17597	218,175	6.00	1/01/34	GOVT	2.99	5.97%
FHLMC GOLD POOL - A22067	264,214	6.50	5/01/34	GOVT	2.69	6.43%
FHLMC GOLD POOL - A24756	170,971	6.00	7/01/34	GOVT	3.26	5.99%
FHLMC GOLD POOL - C01649	111,382	5.50	10/01/33	GOVT	3.54	5.50%
FHLMC GOLD POOL - C01672	796,267	6.00	10/01/33	GOVT	3.04	5.98%
FHLMC GOLD POOL - C69011	169,060	6.50	7/01/32	GOVT	2.60	6.43%
FHLMC GOLD POOL - C76371	569,293	5.00	2/01/33	GOVT	4.15	5.01%
FHLMC GOLD POOL - C79584	244,788	5.50	5/01/33	GOVT	3.52	5.50%

VERMONT MUNICIPAL EMPLOYEES

BOND HOLDINGS

AS OF 3/05

SEIX CORE

<u>BOND NAME</u>	<u>MARKET VALUE</u>	<u>COUPON</u>	<u>STATED MATURITY</u>	<u>MOODY RATE</u>	<u>DUR- ATION</u>	<u>YIELD TO MATURITY</u>
FHLMC_T-049- AV	51,230	3.02	12/25/32	GOVT	0.07	3.00%
FLEET_HELOC_2003-001- A	143,900	3.10	1/20/33	AAA	0.06	3.09%
FNMA POOL - 252255	23,093	6.50	2/01/29	GOVT	2.92	6.38%
FNMA POOL - 254263	102,609	6.50	4/01/32	GOVT	2.88	6.37%
FNMA POOL - 254516	15,383	6.50	11/01/32	GOVT	2.66	6.33%
FNMA POOL - 254724	41,592	5.00	4/01/33	GOVT	4.18	4.98%
FNMA POOL - 254779	74,608	7.00	5/01/33	GOVT	2.38	6.77%
FNMA POOL - 254923	29,532	7.00	8/01/33	GOVT	2.33	6.76%
FNMA POOL - 254933	259,553	6.50	9/01/33	GOVT	2.56	6.31%
FNMA POOL - 254974	25,268	7.00	10/01/33	GOVT	2.42	6.78%
FNMA POOL - 255001	32,368	6.50	11/01/33	GOVT	2.58	6.32%
FNMA POOL - 313877	22,013	6.50	12/01/27	GOVT	3.05	6.40%
FNMA POOL - 323835	46,783	6.50	5/01/29	GOVT	2.95	6.39%
FNMA POOL - 451121	36,288	6.50	11/01/28	GOVT	2.87	6.38%
FNMA POOL - 535285	21,009	6.50	2/01/30	GOVT	2.82	6.38%
FNMA POOL - 535899	107,263	6.00	4/01/31	GOVT	3.10	5.91%
FNMA POOL - 540913	27,964	7.00	6/01/31	GOVT	2.42	6.79%
FNMA POOL - 639252	16,800	6.50	11/01/32	GOVT	2.46	6.29%
FNMA POOL - 649053	68,814	7.00	6/01/32	GOVT	2.83	6.86%
FNMA POOL - 650076	124,191	7.00	7/01/32	GOVT	2.56	6.82%
FNMA POOL - 655780	64,811	6.50	8/01/32	GOVT	2.56	6.32%
FNMA POOL - 685396	166,138	6.50	2/01/33	GOVT	2.66	6.34%
FNMA POOL - 687692	226,884	5.50	3/01/33	GOVT	3.65	5.47%
FNMA POOL - 688251	583,464	5.50	2/01/33	GOVT	3.92	5.48%
FNMA POOL - 689022	509,662	5.00	5/01/33	GOVT	4.43	4.98%
FNMA POOL - 694541	19,622	6.50	10/01/32	GOVT	2.68	6.34%
FNMA POOL - 694760	180,651	5.50	4/01/33	GOVT	3.72	5.47%
FNMA POOL - 695635	153,205	5.50	3/01/33	GOVT	3.93	5.48%

VERMONT MUNICIPAL EMPLOYEES

BOND HOLDINGS

AS OF 3/05

SEIX CORE

<u>BOND NAME</u>	<u>MARKET VALUE</u>	<u>COUPON</u>	<u>STATED MATURITY</u>	<u>MOODY RATE</u>	<u>DUR- ATION</u>	<u>YIELD TO MATURITY</u>
FNMA POOL - 697254	459,843	5.00	9/01/33	GOVT	4.76	4.99%
FNMA POOL - 698156	272,000	5.50	4/01/33	GOVT	3.68	5.47%
FNMA POOL - 704101	198,046	5.50	5/01/33	GOVT	3.79	5.47%
FNMA POOL - 704395	63,983	6.50	5/01/33	GOVT	2.42	6.28%
FNMA POOL - 713589	163,049	7.00	4/01/33	GOVT	2.37	6.78%
FNMA POOL - 720006	54,194	5.50	7/01/33	GOVT	3.62	5.47%
FNMA POOL - 723836	90,386	5.50	6/01/33	GOVT	3.72	5.47%
FNMA POOL - 728792	230,027	5.50	8/01/33	GOVT	3.43	5.45%
FNMA POOL - 729935	175,170	5.50	10/01/33	GOVT	3.08	5.42%
FNMA POOL - 730817	42,840	5.00	8/01/33	GOVT	4.50	4.98%
FNMA POOL - 734235	25,046	7.00	6/01/33	GOVT	2.50	6.80%
FNMA POOL - 737265	60,120	7.00	9/01/33	GOVT	2.40	6.78%
FNMA POOL - 739539	26,166	6.50	10/01/33	GOVT	2.47	6.29%
FNMA POOL - 743235	47,707	5.50	10/01/33	GOVT	3.23	5.44%
FNMA POOL - 743515	18,064	7.00	10/01/33	GOVT	2.25	6.74%
FNMA POOL - 743541	740,893	5.50	11/01/33	GOVT	3.15	5.43%
FNMA POOL - 747618	27,224	7.00	11/01/33	GOVT	2.45	6.79%
FNMA POOL - 748109	115,836	6.50	10/01/33	GOVT	2.56	6.32%
FNMA POOL - 751810	95,613	6.50	10/01/33	GOVT	2.52	6.31%
FNMA POOL - 752412	98,197	5.50	11/01/33	GOVT	3.03	5.41%
FNMA POOL - 753124	112,233	6.50	12/01/33	GOVT	2.67	6.34%
FNMA POOL - 753420	116,239	5.50	11/01/33	GOVT	3.47	5.46%
FNMA POOL - 753514	151,914	6.00	11/01/33	GOVT	2.78	5.86%
FNMA POOL - 753994	56,806	6.00	12/01/33	GOVT	2.78	5.87%
FNMA POOL - 755813	64,305	6.50	11/01/33	GOVT	2.60	6.33%
FNMA POOL - 759039	70,399	7.00	1/01/34	GOVT	2.28	6.75%
FNMA POOL - 769820	100,958	6.00	3/01/34	GOVT	3.01	5.91%
FNMA POOL - 770327	123,693	6.00	4/01/34	GOVT	2.75	5.85%

VERMONT MUNICIPAL EMPLOYEES

BOND HOLDINGS

AS OF 3/05

SEIX CORE

<u>BOND NAME</u>	<u>MARKET VALUE</u>	<u>COUPON</u>	<u>STATED MATURITY</u>	<u>MOODY RATE</u>	<u>DUR-ATION</u>	<u>YIELD TO MATURITY</u>
FNMA POOL - 770439	99,979	6.00	4/01/34	GOVT	2.71	5.84%
FNMA POOL - 772255	65,630	6.00	11/01/33	GOVT	2.62	5.83%
FNMA POOL - 775075	139,114	6.00	5/01/34	GOVT	2.92	5.89%
FNMA POOL - 775611	82,423	6.50	5/01/34	GOVT	2.48	6.29%
FNMA POOL - 787810	184,692	6.50	7/01/34	GOVT	2.75	6.35%
FNMA_2002-T10- IA1	61,713	2.97	6/25/32	AAA	0.08	3.04%
FNMA_2002-T13- A	77,762	2.95	8/25/32	GOVT	0.07	2.96%
FORD MOTOR COMPANY	360,407	7.45	7/16/31	BAA1	12.30	8.35%
GNMA POOL - 552903	34,162	6.50	11/15/32	GOVT	3.00	6.46%
GNMA POOL - 553125	55,093	6.00	3/15/33	GOVT	3.44	6.00%
GNMA POOL - 587025	45,219	6.50	4/15/32	GOVT	3.24	6.48%
GNMA POOL - 603413	67,969	6.50	1/15/33	GOVT	3.10	6.47%
GNMA POOL - 604470	185,501	5.00	7/15/33	GOVT	5.62	5.02%
GNMA POOL - 605426	76,432	5.00	5/15/34	GOVT	N/A	N/A
GNMA POOL - 606851	22,417	6.50	7/15/32	GOVT	3.17	6.48%
GNMA POOL - 610851	154,225	6.00	4/15/33	GOVT	3.53	6.00%
GNMA POOL - 620535	100,446	5.00	8/15/33	GOVT	5.63	5.02%
GNMA POOL - 781288	27,229	6.50	5/15/31	GOVT	3.32	6.48%
GNMA POOL - 781548	0	7.00	11/15/32	GOVT	3.03	6.97%
GPHE 2003 1 A	85,946	1.59	4/15/29	AAA	N/A	N/A
HSBC HLDGS PLC 144A	108,960	7.63	5/17/32	AA3	12.53	5.79%
K N CAP TR III	118,888	7.63	4/15/28	BAA3	11.33	6.37%
K N ENERGY	57,072	7.25	3/01/28	BAA2	11.70	6.17%
MELLON_HEL_2001-01- A	153,533	3.09	3/20/27	AAA	0.04	3.00%
MEXICO(UNITED MEXICAN STAT	347,432	8.30	8/15/31		N/A	N/A
MLCC_HEL_1997-001- A	7,999	3.03	9/25/27	AAA	0.07	3.04%
NEWS AMERICA INC 144A	55,326	6.20	12/15/34	BAA3	13.46	6.28%
NEW_CENTURY_1999-NCB- A7	23,208	7.54	9/25/29	AAA	0.74	6.18%

VERMONT MUNICIPAL EMPLOYEES

BOND HOLDINGS

AS OF 3/05

SEIX CORE

<u>BOND NAME</u>	<u>MARKET VALUE</u>	<u>COUPON</u>	<u>STATED MATURITY</u>	<u>MOODY RATE</u>	<u>DUR- ATION</u>	<u>YIELD TO MATURITY</u>
ONCOR ELEC DELIVERY	65,415	7.00	5/01/32	BAA1	12.46	5.87%
PAC G&E	181,359	6.05	3/01/34	BAA1	13.58	5.86%
RAMP_2003-RS2- AII	330	3.19	3/25/33	AAA	0.06	3.14%
RASC_2003-KS4- AIIIB	181,412	3.14	6/25/33	AAA	0.09	3.12%
RFMS2 2003-HS1 AII	63,989	1.62	12/25/32	AAA	N/A	N/A
SASC_2002-BC3- AMBI	72,358	3.18	6/25/32	N/A	0.07	3.19%
SBC COMMUNICATIONS INC	53,240	6.45	6/15/34	A2	13.52	6.15%
SOUNDVIEW_HEL_2001-01- A	15,424	6.26	4/15/31	AAA	3.56	6.01%
SPRINT CAP CORP	228,093	8.75	3/15/32	BAA3	12.33	6.42%
UNITED STATES TREAS BDS	1,916,622	3.88	4/15/29	GOVT	N/A	N/A
UNITED STATES TREAS BONDS	1,535,914	5.38	2/15/31	GOVT	14.14	4.77%
VERIZON GLOBAL	98,747	7.75	12/01/30	A2	12.29	6.13%
WASI 2002-HE2 A	218,054	1.78	12/25/32	AAA	N/A	N/A
WASI 2003-HE 1 A1	119,747	1.60	3/25/33	AAA	N/A	N/A
WEYERHAEUSER	60,034	7.38	3/15/32	BAA2	12.72	6.09%
	<u>21,939,270</u>	<u>5.52</u>			<u>5.36</u>	<u>5.57%</u>

VERMONT MUNICIPAL EMPLOYEES

BOND HOLDINGS

AS OF 3/05

SEIX HIGH YIELD

	<u>BOND NAME</u>	<u>MARKET VALUE</u>	<u>COUPON</u>	<u>STATED MATURITY</u>	<u>MOODY RATE</u>	<u>DUR-ATION</u>	<u>YIELD TO MATURITY</u>
0-5 YEARS	ALLIED WASTE NA	97,677	8.50	12/01/08	B2	3.04	7.70%
	ALLIED WASTE NA	6,947	8.88	4/01/08	B2	2.50	7.60%
	AMERICAN STANDARD INC	19,961	7.38	2/01/08	BAA3	2.53	4.73%
	AMERIGAS PARTNERS L P	7,546	10.00	4/15/06	B2	0.95	5.00%
	AMERISTAR CASINOS INC	30,729	10.75	2/15/09	B2	0.92	5.80%
	AVAYA INC	29,324	11.13	4/01/09	NR	0.91	5.19%
	BALL CORP	1,799	7.75	8/01/06	BA2	1.25	5.28%
	BRL UNIVERSAL EQUIP 2001	6	8.88	2/15/08	NR	1.31	-1.00%
	CANANDAIGUA BRANDS INC	31,464	8.63	8/01/06	BA2	1.25	5.08%
	CAPITOL RECORDS INC 144A	38,466	8.38	8/15/09	BA1	3.63	6.38%
	CHESAPEAKE ENERGY CORP	17,560	8.38	11/01/08	BA3	0.68	4.14%
	CHOCTAW RESORT DEV ENTERP	39,605	9.25	4/01/09	B1	0.00	0.00%
	CITGO PETE CORP	4,441	7.88	5/15/06	BA2	1.04	4.63%
	CORRECTIONS CORP AMER	39,664	9.88	5/01/09	B1	1.00	3.91%
	CSC HLDGS INC	17,666	7.25	7/15/08	B1	2.86	6.39%
	DEAN FOODS CO	83,127	8.15	8/01/07	BA2	2.09	5.60%
	DEX MEDIA EAST LLC/DEX	70,869	9.88	11/15/09	B1	1.96	6.23%
	ECHOSTAR DBS CORP	75,405	5.75	10/01/08	BA3	3.04	6.23%
	ECHOSTAR DBS CORP	78,313	9.13	1/15/09	BA3	1.34	5.64%
	ECHOSTAR DBS CORP	1	10.38	10/01/07	NR	1.02	-1.00%
	EDISON MISSION ENERGY	3,799	10.00	8/15/08	B1	2.85	6.28%
	ENTRAVISION COMMUNICATION	10,649	8.13	3/15/09	B3	2.45	6.52%
	FAIRCHILD SEMICONDUCTOR C	3	10.50	2/01/09	NR	1.23	-1.00%
	FOREST OIL CORP	54,373	8.00	6/15/08	BA3	2.76	5.83%
	GAP INC	51,565	8.80	12/15/08	BA1	3.15	4.00%
GEORGIA PACIFIC	39,000	8.88	2/01/10	BA2	3.92	6.06%	
GEORGIA PACIFIC	71,974	7.38	7/15/08	BA2	2.87	5.76%	
HANOVER EQUIP TR 2001A	3,383	8.50	9/01/08	B2	1.75	6.56%	

VERMONT MUNICIPAL EMPLOYEES

BOND HOLDINGS

AS OF 3/05

SEIX HIGH YIELD

<u>BOND NAME</u>	<u>MARKET VALUE</u>	<u>COUPON</u>	<u>STATED MATURITY</u>	<u>MOODY RATE</u>	<u>DUR-ATION</u>	<u>YIELD TO MATURITY</u>
HOST MARRIOTT L P	17,904	9.25	10/01/07	BA3	2.14	6.18%
HOST MARRIOTT L P	20,796	9.50	1/15/07	BA3	1.62	6.19%
ISTAR FINL INC	44,077	8.75	8/15/08	BAA3	2.92	4.89%
ISTAR FINL INC	43,400	7.00	3/15/08	BAA3	2.66	4.81%
MANDALAY RESORT GRP	30,630	9.50	8/01/08	BA2	2.83	6.37%
MANDALAY RESORT GRP	158,870	10.25	8/01/07	BA3	2.05	6.16%
MGM MIRAGE INC	51,907	9.75	6/01/07	BA3	1.90	6.00%
MGM MIRAGE INC	11,183	6.00	10/01/09	BA2	3.77	6.36%
MIDWEST_GEN_2000- A	18,652	8.30	7/02/09	B1	2.69	5.39%
NEXTEL COMM INC	2	9.38	11/15/09	NR	1.01	-1.00%
NMHG HLDG CO	19,774	10.00	5/15/09	B3	1.89	7.04%
OFFICE DEPOT INC	2	10.00	7/15/08	NR	0.07	0.00%
OWENS BROCKWAY GLASS	27,226	8.88	2/15/09	B1	1.58	5.84%
PACIFICARE HEALTH SYS INC	36,139	10.75	6/01/09	BA3	1.17	5.81%
PARK PLACE ENT	32,082	7.50	9/01/09	BA1	3.74	5.56%
PENN NATL GAMING INC	14,978	8.88	3/15/10	B2	2.15	6.85%
PETROLEUM HELICOPTERS INC	22,168	9.38	5/01/09	B1	2.17	7.08%
PREM COR REFNG GROUP	51,173	9.25	2/01/10	BA3	2.18	5.84%
PSEG ENERGY	46,589	7.75	4/16/07	BA3	1.81	6.29%
PSEG ENERGY HLDGS	28,558	10.00	10/01/09	BA3	3.50	6.79%
PSEG ENERGY HLDGS	113,994	8.63	2/15/08	BA3	2.51	6.49%
SANMINA CORP	92,734	10.38	1/15/10	BA2	1.84	5.98%
SEAGATE TECHNOLOGY HDD HL	26,979	8.00	5/15/09	BA2	1.98	5.67%
SELECT MED CORP	0	9.50	6/15/09	NR	0.06	-1.00%
SERVICE CORP INTL	64,059	7.70	4/15/09	BA3	3.33	6.84%
SERVICE CORP INTL	21,477	6.88	10/01/07	BA3	2.20	6.33%
SERVICE CORP INTL	27,423	7.20	6/01/06	BA3	1.09	5.84%
SERVICE CORP INTL	4,757	6.50	3/15/08	BA3	2.65	6.40%

VERMONT MUNICIPAL EMPLOYEES

BOND HOLDINGS

AS OF 3/05

SEIX HIGH YIELD

	<u>BOND NAME</u>	<u>MARKET VALUE</u>	<u>COUPON</u>	<u>STATED MATURITY</u>	<u>MOODY RATE</u>	<u>DUR-ATION</u>	<u>YIELD TO MATURITY</u>
	SITHE / INDEPENDENCE FDG C	1	8.50	6/30/07	BA2	0.57	0.00%
	SMITHFIELD FOODS INC	29,268	8.00	10/15/09	BA2	3.67	6.45%
	STANDARD PACIFIC CORP	11,136	6.50	10/01/08	BA2	3.00	6.34%
	STEWART ENTERPRISES	78,259	10.75	7/01/08	NR	0.25	4.33%
	STONE CONTAINER CORP	20,362	9.25	2/01/08	B2	2.46	6.69%
	UNISYS CORP	67,292	6.88	3/15/10	BA1	4.12	6.93%
	UNISYS CORP	28,015	8.13	6/01/06	BA1	1.08	5.86%
	XEROX CORP	82,207	9.75	1/15/09	BA2	3.15	5.94%
		<u>2,269,387</u>	<u>8.80</u>			<u>2.29</u>	<u>5.85%</u>
5-10 YEARS	AES CORP	5,385	9.38	9/15/10	B1	4.28	7.08%
	AES CORP 144A	117,487	8.75	5/15/13	BA3	3.81	6.78%
	AINSWORTH LMBR LTD 144A	12,582	7.25	10/01/12	B2	5.23	7.60%
	AIRGAS INC	9,605	6.25	7/15/14	BA2	6.24	6.28%
	ALDERWOODS GROUP INC 144A	16,374	7.75	9/15/12	B2	4.88	7.24%
	ALIMENT COUCHE TARD	13,298	7.50	12/15/13	BA3	5.05	6.56%
	ALLIED WASTE NA	43,304	9.25	9/01/12	B2	3.69	7.64%
	AMERIGAS PRTRNS LP/AP EAG	35,370	8.88	5/20/11	B2	2.43	7.09%
	APPLETON PAPERS INC	1	8.13	6/15/11	B2	0.06	-1.00%
	APPLETON PAPERS INC	1	9.75	6/15/14	B3	0.06	-1.00%
	ARCH WESTERN FIN 144A	38,850	6.75	7/01/13	BA3	5.45	6.65%
	ARGOSY GAMING CO	61,941	9.00	9/01/11	BA3	1.46	5.15%
	ARGOSY GAMING CO	43,495	7.00	1/15/14	B1	6.52	5.80%
	BALL CORP	39,685	6.88	12/15/12	BA2	4.66	6.21%
	BERRY PLASTICS	16,719	10.75	7/15/12	B3	2.23	6.84%
	BIO RAD LABS	3,646	7.50	8/15/13	BA3	4.95	6.62%
	BORDEN US FIN CORP 144A	20,874	9.00	7/15/14	B3	4.98	7.55%
	BOYD GAMING CORP	33,488	6.75	4/15/14	B1	5.97	6.94%

VERMONT MUNICIPAL EMPLOYEES

BOND HOLDINGS

AS OF 3/05

SEIX HIGH YIELD

<u>BOND NAME</u>	<u>MARKET VALUE</u>	<u>COUPON</u>	<u>STATED MATURITY</u>	<u>MOODY RATE</u>	<u>DUR-ATION</u>	<u>YIELD TO MATURITY</u>
BOYD GAMING CORP	14,983	7.75	12/15/12	B1	4.33	6.73%
BUILDING MATLS CORP AMER	1	7.75	8/01/14	B2	0.88	-1.00%
C H C HELICOPTER CORP	21,620	7.38	5/01/14	B2	5.96	7.78%
CANWEST MEDIA INC	54,232	7.63	4/15/13	BA3	4.40	6.51%
CARTER WILLIAM CO	8,089	10.88	8/15/11	B3	1.38	6.58%
CASELLA WASTE SYSTEMS	20,533	9.75	2/01/13	B3	3.42	7.35%
CB RICHARD ELLIS SVCS INC	21,531	11.25	6/15/11	B3	1.11	5.40%
CB RICHARD ELLIS SVCS INC	19,326	9.75	5/15/10	B1	2.03	5.38%
CENTURY ALUMINUM CO 144A	11,910	7.50	8/15/14	B1	5.98	7.32%
CHARTER COMM OPERATING 1	22,391	8.38	4/30/14	B2	5.58	8.28%
CHESAPEAKE ENERGY CORP	36,183	9.00	8/15/12	BA3	2.69	6.03%
CHESAPEAKE ENERGY CORP	93,911	7.50	9/15/13	BA3	4.87	6.44%
CHESAPEAKE ENERGY CORP	28,336	7.75	1/15/15	BA3	4.51	6.54%
CHESAPEAKE ENERGY CORP	1,026	7.50	6/15/14	BA3	5.30	6.49%
CHIQUITA BRANDS INTL 144A	6,214	7.50	11/01/14	B2	6.03	7.57%
CHUMASH CASINO & RESORT E	22,832	9.00	7/15/10	BA3	2.24	6.57%
CITGO PETROLEUM CORP	6	11.38	2/01/11	BA2	1.00	-1.00%
CONSOLIDATED COMM 144A	14,904	9.75	4/01/12	B3	3.90	8.26%
CONSTELLATION BRANDS INC	10,124	8.13	1/15/12	BA3	2.81	6.11%
CORNING INC	26,556	5.90	3/15/14	BA2	6.85	5.95%
CORRECTIONS CORP AMER	54,648	7.50	5/01/11	B1	4.02	7.14%
COVENTRY HEALTH CARE	41,020	8.13	2/15/12	BA1	2.36	5.38%
CROWN EUROPEAN HLDGS	48,452	10.88	3/01/13	B2	2.62	6.48%
CRUM & FOSTER HLDGS CORP	6,440	10.38	6/15/13	BA3	5.48	8.32%
DADE BEHRING INC	42,381	11.91	10/14/10	B2	0.47	5.43%
DEL MONTE CORPORATION	8,287	8.63	12/15/12	B2	3.57	6.71%
DEX MEDIA WEST LLC	18,659	8.50	8/15/10	B1	3.40	6.69%
DEX MEDIA WEST LLC	54,461	9.88	8/15/13	B2	3.70	7.28%

VERMONT MUNICIPAL EMPLOYEES

BOND HOLDINGS

AS OF 3/05

SEIX HIGH YIELD

<u>BOND NAME</u>	<u>MARKET VALUE</u>	<u>COUPON</u>	<u>STATED MATURITY</u>	<u>MOODY RATE</u>	<u>DUR-ATION</u>	<u>YIELD TO MATURITY</u>
DIRECTV HLDGS	229,941	8.38	3/15/13	BA2	3.88	6.56%
DYNEGY INC	57,302	10.13	7/15/13	B3	4.05	8.25%
ECHOSTAR DBS CORP	56,176	6.38	10/01/11	BA3	5.07	6.76%
ECHOSTAR DBS CORP 144A	22,923	6.63	10/01/14	BA3	6.67	7.12%
EDISON MISSION ENERGY	98,525	9.88	4/15/11	B1	4.46	6.71%
EL PASO ENERGY PARTNERS	2	8.50	6/01/11	NR	0.05	-1.00%
EL PASO ENERGY PARTNERS L	5	10.63	12/01/12	NR	0.05	-1.00%
ELIZABETH ARDEN INC	24,724	7.75	1/15/14	B2	5.42	7.18%
EMMIS OPERATING CO	23,052	6.88	5/15/12	B2	5.03	7.24%
ENCORE ACQUISITION	13,843	8.38	6/15/12	B2	3.03	6.23%
ENCORE ACQUISITION	9,490	6.25	4/15/14	B2	6.63	6.25%
ENTERPRISE PRODUCTS 144A	56,505	5.60	10/15/14	BAA3	7.11	5.78%
EVERGREEN RES INC	19,515	5.88	3/15/12	NR	4.81	5.48%
EXCO RESOURCES	51,086	7.25	1/15/11	B2	4.61	6.93%
FAIRFAX FINL HLDGS	2,121	7.75	4/26/12	BA3	5.14	8.41%
FERRELLGAS LP	18,239	6.75	5/01/14	BA3	6.09	7.13%
FERRELLGAS PARTNERS L P/F	43,933	8.75	6/15/12	B2	4.08	7.80%
FIRSTENERGY CORP	113,705	6.45	11/15/11	BAA3	5.27	5.45%
FOREST OIL CORP	7,200	8.00	12/15/11	BA3	5.12	6.15%
FOREST OIL CORP	2	8.00	12/15/11	BA3	0.06	0.00%
FOUNDATION PENN 144A	6,467	7.25	8/01/14	B1	5.95	6.98%
FREESCALE SEMICONDUCTOR I	1	7.13	7/15/14	BA2	0.07	-1.00%
FREESCALE SEMICONDUCTOR IN	1	6.88	7/15/11	BA2	0.07	0.00%
FRONTIER OIL CORP	1	6.63	10/01/11	B1	0.78	0.00%
GCI INC	44,956	7.25	2/15/14	B2	6.03	7.72%
GENERAL CABLE CORP	49,492	9.50	11/15/10	B2	4.25	7.30%
GEO GROUP INC	24,875	8.25	7/15/13	B1	5.14	7.84%
GEORGIA PACIFIC	51,367	8.13	5/15/11	BA3	4.73	6.09%

VERMONT MUNICIPAL EMPLOYEES

BOND HOLDINGS

AS OF 3/05

SEIX HIGH YIELD

<u>BOND NAME</u>	<u>MARKET VALUE</u>	<u>COUPON</u>	<u>STATED MATURITY</u>	<u>MOODY RATE</u>	<u>DUR-ATION</u>	<u>YIELD TO MATURITY</u>
GEORGIA PACIFIC	17,702	9.50	12/01/11	BA3	4.94	6.16%
GOLD KIST INC	28,295	10.25	3/15/14	B2	5.99	8.03%
GRAPHIC PKG INTL	25,370	9.50	8/15/13	B3	4.62	8.27%
GRAY TELEVISION INC	25,887	9.25	12/15/11	B2	2.50	6.79%
GROUP I AUTOMOTIVE INC	13,954	8.25	8/15/13	B1	5.32	8.04%
HANOVER COMPRESSOR	15,082	9.00	6/01/14	B3	4.97	7.71%
HANOVER COMPRESSOR	13,015	8.63	12/15/10	B3	3.84	7.47%
HANOVER EQUIP TR 2001A	24,227	8.75	9/01/11	B2	3.04	7.27%
HCA INC	55,261	6.95	5/01/12	BA2	5.41	6.28%
HCA INC	14,057	7.88	2/01/11	BA2	4.64	6.18%
HCA INC	39,847	8.75	9/01/10	BA2	4.34	6.02%
HCA INC	31,147	6.30	10/01/12	BA2	5.72	6.32%
HEALTH CARE REIT INC	33,839	6.00	11/15/13	BAA3	6.56	5.73%
HILTON HOTELS CORP	38,039	8.25	2/15/11	BAA3	4.70	5.20%
HOST MARRIOTT L P	23,927	7.13	11/01/13	BA3	5.64	7.24%
HOVNIANIAN K ENTERPRISES	13,625	8.00	4/01/12	BA1	2.99	6.14%
HOVNIANIAN K ENTERPRISES	6,734	6.38	12/15/14	BA1	6.95	6.87%
HUNTSMAN LLC	41,114	11.63	10/15/10	B1	2.23	6.40%
IASIS HEALTHCARE CORP	3	8.75	6/15/14	B3	0.06	-1.00%
INMARSAT FIN PLC 144A	59,297	7.63	6/30/12	B2	5.04	7.62%
INTRAWEST CORP	1	7.50	10/15/13	B1	0.03	-1.00%
ISLE CAPRI CASINOS INC	20,527	9.00	3/15/12	B2	2.59	6.36%
ISTAR FINL INC	20,774	5.13	4/01/11	BAA3	4.97	5.60%
ISTAR FINL INC	26,218	6.00	12/15/10	BAA3	4.73	5.36%
ISTAR FINL INC	18,053	6.50	12/15/13	BAA3	4.87	5.75%
JEAN COUTU GROUP PJC 144A	6,734	8.50	8/01/14	B3	5.85	8.58%
JEAN COUTU GROUP PJC 144A	40,968	7.63	8/01/12	B2	4.66	6.77%
JEFFERSON SMURFIT CORP	57,939	7.50	6/01/13	B2	5.36	7.58%

VERMONT MUNICIPAL EMPLOYEES

BOND HOLDINGS

AS OF 3/05

SEIX HIGH YIELD

<u>BOND NAME</u>	<u>MARKET VALUE</u>	<u>COUPON</u>	<u>STATED MATURITY</u>	<u>MOODY RATE</u>	<u>DUR-ATION</u>	<u>YIELD TO MATURITY</u>
JEFFERSON SMURFIT CORP	41,297	8.25	10/01/12	B2	4.45	7.63%
JOSTENS INC 144A	23,902	7.63	10/01/12	B3	5.02	7.80%
K 2 INC	1	7.38	7/01/14	BA3	0.06	-1.00%
KABEL DEUTSCHLAND GMBH 14	64,767	10.63	7/01/14	B2	4.46	8.49%
KINETIC CONCEPTS	16,262	7.38	5/15/13	B3	4.77	6.57%
KOPPERS INC	14,634	9.88	10/15/13	B2	5.64	7.99%
L-3 COMMUNICATIONS CORP	46,952	7.63	6/15/12	BA3	3.48	6.17%
LEUCADIA NATL 144A	17,053	7.00	8/15/13	BA2	6.19	7.04%
LNR PROPERTY CORP	49,246	7.63	7/15/13	CAA1	3.92	5.58%
LNR PROPERTY CORP	55,442	7.25	10/15/13	CAA1	4.30	5.59%
LUSCAR COAL LTD	28,108	9.75	10/15/11	BA3	1.57	5.92%
LYONDELL CHEM WW	35,045	10.25	11/01/10	B1	4.16	7.26%
LYONDELL CHEMICAL CO	33,350	11.13	7/15/12	B1	2.03	6.28%
MACDERMID INC	27,914	9.13	7/15/11	BA3	2.17	6.60%
MASSEY ENERGY CO	19,881	6.63	11/15/10	BA3	4.21	6.50%
MEDIANEWS GROUP	22,812	6.88	10/01/13	B2	5.70	7.19%
MERITAGE CORP	25,382	9.75	6/01/11	BA3	1.09	3.50%
MGM MIRAGE INC	138,135	8.50	9/15/10	BA2	4.37	6.41%
MILLAR WESTN FST PRODS	22,278	7.75	11/15/13	B2	5.58	7.91%
MORRIS PUBG GROUP	29,014	7.00	8/01/13	BA3	5.64	7.16%
MSW ENERGY HLDGS	44,803	7.38	9/01/10	BA2	4.03	6.97%
MSW ENERGY HLDGS	31,432	8.50	9/01/10	BA1	3.66	7.16%
NALCO CO	39,695	7.75	11/15/11	B2	4.04	6.73%
NAVISTAR INTL CORP	8,830	7.50	6/15/11	BA3	4.49	7.32%
NEXTEL COMM INC	87,855	9.50	2/01/11	BA3	0.81	1.82%
NEXTEL COMM INC	30,341	5.95	3/15/14	BA3	6.14	6.02%
NEXTEL COMM INC	70,561	6.88	10/31/13	BA3	5.04	6.08%
NORTEK INC	3	8.50	9/01/14	B3	0.93	-1.00%

VERMONT MUNICIPAL EMPLOYEES

BOND HOLDINGS

AS OF 3/05

SEIX HIGH YIELD

<u>BOND NAME</u>	<u>MARKET VALUE</u>	<u>COUPON</u>	<u>STATED MATURITY</u>	<u>MOODY RATE</u>	<u>DUR- ATION</u>	<u>YIELD TO MATURITY</u>
NRG ENERGY INC 144A	64,367	8.00	12/15/13	B1	4.91	6.91%
NTL CABLE PLC 144A	52,171	8.75	4/15/14	B3	4.75	7.32%
OMEGA HEALTHCARE INVS INC	1	7.00	4/01/14	B1	0.66	-1.00%
OWENS BROCKWAY GLASS	53,973	8.75	11/15/12	B1	3.22	6.42%
OWENS BROCKWAY GLASS	13,924	7.75	5/15/11	B1	3.65	6.64%
PANAMSAT CORP NEW 144A	72,953	9.00	8/15/14	B1	5.35	7.99%
PANTRY INC	22,121	7.75	2/15/14	B3	5.41	7.09%
PEABODY ENERGY	24,357	6.88	3/15/13	BA3	4.95	6.26%
PETCO ANIMAL SUPPLIES	8,635	10.75	11/01/11	B1	1.43	5.97%
PINNACLE FOODS HLDG	9,827	8.25	12/01/13	B3	5.67	10.43%
PINNACLE FOODS HLDG 144A	4,623	8.25	12/01/13	B3	5.67	10.43%
PLASTIPAK HLDGS INC	11,153	10.75	9/01/11	B3	1.36	6.20%
PLY GEM INDUS INC 144A	8,836	9.00	2/15/12	B3	4.79	10.13%
PREMCOR REFNG GROUP	17,885	6.13	5/01/11	BA3	4.88	6.22%
PREMCOR REFNG GROUP	39,898	6.75	2/01/11	BA3	4.73	6.28%
PREMCOR REFNG GROUP	37,824	7.75	2/01/12	B2	4.34	6.94%
PREMCOR REFNG GROUP	8,757	9.50	2/01/13	BA3	3.02	6.44%
QUEBECOR MEDIA INC	6,823	11.13	7/15/11	B2	1.26	6.67%
QWEST CORP 144A	73,236	7.88	9/01/11	BA3	4.97	7.28%
R H DONNELLEY CORP	93,736	10.88	12/15/12	B2	2.41	6.50%
R H DONNELLEY CORP	27,946	10.88	12/15/12	B2	2.41	6.50%
R H DONNELLEY CORP	10,268	8.88	12/15/10	BA3	2.19	5.76%
RADIO ONE INC	57,676	8.88	7/01/11	B2	2.15	6.41%
READERS DIGEST ASSN	42,709	6.50	3/01/11	BA3	4.54	6.55%
RELIANT RES INC	16,403	9.25	7/15/10	B1	3.29	7.31%
RELIANT RES INC	20,071	9.50	7/15/13	B1	4.09	7.70%
RENT A CTR INC	51,322	7.50	5/01/10	B1	3.77	7.62%
RITE AID CORP	29,852	8.13	5/01/10	B2	3.65	7.69%

VERMONT MUNICIPAL EMPLOYEES

BOND HOLDINGS

AS OF 3/05

SEIX HIGH YIELD

<u>BOND NAME</u>	<u>MARKET VALUE</u>	<u>COUPON</u>	<u>STATED MATURITY</u>	<u>MOODY RATE</u>	<u>DUR- ATION</u>	<u>YIELD TO MATURITY</u>
RITE AID CORP	28,085	9.50	2/15/11	B2	3.17	7.67%
ROGERS WIRELESS	57,734	6.38	3/01/14	BA3	6.63	6.83%
RYLAND GROUP INC	19,550	9.75	9/01/10	BAA3	0.41	7.52%
SALTON SEA FDG CORP	3	7.84	5/30/10	BA1	0.96	0.00%
SAMSONITE CORP	2	8.88	6/01/11	B3	0.05	-1.00%
SCOTTS CO	12,241	6.63	11/15/13	BA2	6.34	6.47%
SELECT MED CORP	1	7.50	8/01/13	NR	0.90	-1.00%
SEMINIS VEG SEEDS	43,763	10.25	10/01/13	B3	2.96	5.83%
SERVICE CORP INTL	453	7.88	2/01/13	BA3	5.74	7.36%
SHAW COMMUNICATIONS	21,340	7.20	12/15/11	BA2	5.22	5.96%
SILGAN HOLDINGS INC	32,680	6.75	11/15/13	B1	5.57	6.56%
SINCLAIR BROADCAST GRP	57,463	8.75	12/15/11	B2	3.45	7.46%
SITHE / INDEPENDENCE FDG C	5	9.00	12/30/13	BA2	0.06	0.00%
SMITHFIELD FOODS INC	37,094	7.75	5/15/13	BA2	5.87	6.77%
SONIC AUTOMATIC INC	25,022	8.63	8/15/13	B2	5.38	8.71%
SPX CORP	15,450	6.25	6/15/11	BA3	5.07	4.88%
SPX CORP	3,842	7.50	1/01/13	BA3	2.86	4.50%
STANDARD PACIFIC CORP	9,444	6.88	5/15/11	BA2	4.82	6.67%
STATER BROS HLDGS INC	1	8.13	6/15/12	B1	0.06	-1.00%
STATION CASINOS INC	5,471	6.00	4/01/12	BA3	4.90	6.13%
STATION CASINOS INC	38,949	6.50	2/01/14	B1	5.88	6.61%
STONE CONTAINER CORP	13,439	9.75	2/01/11	B2	1.56	6.73%
STONE CONTAINER CORP	16,636	8.38	7/01/12	B2	4.28	7.61%
SUSQUEHANNA MEDIA	16,926	7.38	4/15/13	B1	4.84	6.76%
SWIFT ENERGY CO	24,663	7.63	7/15/11	B1	4.41	6.82%
SWIFT ENERGY CO	20,335	9.38	5/01/12	B2	2.83	7.04%
SYBRON DENTAL SPECIALTIES	19,023	8.13	6/15/12	B1	3.23	6.29%
TRANSCONTINENTAL GAS PIPE	8,304	8.88	7/15/12	BA2	5.42	5.92%

VERMONT MUNICIPAL EMPLOYEES

BOND HOLDINGS

AS OF 3/05

SEIX HIGH YIELD

	<u>BOND NAME</u>	<u>MARKET VALUE</u>	<u>COUPON</u>	<u>STATED MATURITY</u>	<u>MOODY RATE</u>	<u>DUR-ATION</u>	<u>YIELD TO MATURITY</u>
	TRANSMONTAIGNE OIL CO	12,559	9.13	6/01/10	B3	3.28	7.42%
	TRIAD HOSPS INC	92,993	7.00	5/15/12	B2	4.78	6.76%
	TRIAD HOSPS INC	14	7.00	11/15/13	B3	5.77	7.27%
	UGS CORP 144A	28,591	10.00	6/01/12	B3	3.63	7.51%
	UNITED AGRI PRODUCTS 144A	24,928	8.25	12/15/11	B1	4.09	7.23%
	UNITED AUTO GROUP INC	12,353	9.63	3/15/12	B3	3.66	8.25%
	UNIVERSAL COMPRESSION	3,068	7.25	5/15/10	BA3	3.69	6.61%
	UNIVERSAL HOSPITAL SERV	48,957	10.13	11/01/11	B3	4.57	9.60%
	US CONCRETE	19,510	8.38	4/01/14	B3	5.96	8.46%
	VENETIAN CASINO RESORT LL	3	11.00	6/15/10	B2	0.06	-1.00%
	VIDEOTRON LTEE	6,171	6.88	1/15/14	BA3	5.77	6.78%
	WARNER MUSIC GROUP 144A	17,551	7.38	4/15/14	B3	5.48	6.83%
	WILLIAMS COS	62,118	8.13	3/15/12	B1	5.33	6.41%
	WILLIAMS COS	95,408	7.13	9/01/11	B1	5.10	6.29%
	XTO ENERGY INC 144A	22,706	5.00	1/31/15	BAA3	7.56	5.28%
		<u>5,839,436</u>	<u>8.22</u>			<u>4.29</u>	<u>6.68%</u>
10-20 YEARS	AES RED OAK L L C *	12,670	8.54	11/30/19	B2	7.82	7.21%
	CHESAPEAKE ENERGY CORP	25,639	6.88	1/15/16	BA3	6.23	6.69%
	CORNING INC	26,346	6.20	3/15/16	BA2	7.83	6.15%
	CSC HLDGS INC	60,982	10.50	5/15/16	B2	1.03	5.75%
	FAIRFAX FINL HLDGS	34,722	7.38	4/15/18	BA3	7.62	8.81%
	FPL ENERGY WIND FDG 144A	24,516	6.88	6/27/17	BA2	7.98	6.55%
	HOMER CITY FDG LLC	2	8.14	10/01/19	BA2	0.64	0.00%
	KANSAS GAS & ELECTRIC CO	1	8.29	3/29/16	BAA3	1.00	0.00%
	MIDWEST_GEN_2000- B	84,976	8.56	1/02/16	B1	4.90	6.03%
	NEXTEL COMM INC	75,884	7.38	8/01/15	BA3	4.99	6.25%
	PEABODY ENERGY	11,952	5.88	4/15/16	BA3	7.02	6.32%

VERMONT MUNICIPAL EMPLOYEES

BOND HOLDINGS

AS OF 3/05

SEIX HIGH YIELD

	<u>BOND NAME</u>	<u>MARKET VALUE</u>	<u>COUPON</u>	<u>STATED MATURITY</u>	<u>MOODY RATE</u>	<u>DUR-ATION</u>	<u>YIELD TO MATURITY</u>
	ROGERS CABLESYSTEMS LTD	5,096	11.00	12/01/15	B2	0.63	5.27%
	SALTON SEA FDG CORP	1	7.47	11/30/18	BA1	0.77	0.00%
		<u>362,786</u>	<u>8.07</u>			<u>5.16</u>	<u>6.43%</u>
OVER 20 YEARS	AES RED OAK L L C *	17,347	9.20	11/30/29	B2	9.87	8.04%
	AFC CAP TR I	28,144	8.21	2/03/27	BA2	10.17	7.62%
	ALLMERICA FINL CORP	11,400	7.65	10/15/25	BA1	10.16	6.99%
	COLUMBIA/HCA HEALTHCARE	46,537	7.50	11/15/95	BA2	12.27	7.82%
	CROWN CORK & SEAL CO	15,495	7.38	12/15/26	B3	10.00	8.01%
	FAIRFAX FINL HLDGS	25,800	7.75	7/15/37	BA3	10.11	9.21%
	GEORGIA PACIFIC	36,273	8.88	5/15/31	BA3	10.88	7.13%
	HCA INC	10,835	7.50	11/06/33	BA1	11.35	7.35%
	HOMER CITY FUND	29,263	8.73	10/01/26	BA2	9.90	7.27%
	LEUCADIA NATL	10,219	8.65	1/15/27	BA3	6.61	8.51%
	MARKEL CAP TR I	32,629	8.71	1/01/46	BA1	4.08	6.92%
	MIDWEST GENERATION LLC /	0	8.75	5/01/34	B1	0.71	-1.00%
	US WEST COMM	7,868	7.20	11/10/26	BA3	8.92	8.14%
	WILLIAMS COS	21,502	8.75	3/15/32	B1	11.27	7.17%
	XEROX CAP TRUST I	27,004	8.00	2/01/27	BA3	6.57	8.00%
		<u>320,316</u>	<u>8.22</u>			<u>9.55</u>	<u>7.67%</u>

**VERMONT MUNICIPAL EMPLOYEES
PERFORMANCE EVALUATION AND REPORTING SERVICES
INFORMATION DISCLAIMER**

Deutsche Bank Trust Company Americas has exercised reasonable professional care in the preparation of this performance report. However, we cannot guarantee the accuracy of all information contained within.

Information in this report on market indices and security characteristics, as well as information incorporated in the Capital Market Review, is received from sources external to Deutsche Bank Trust Company Americas. While efforts are made to ensure that this data is accurate, the Bank cannot accept responsibility for any errors that may occur.