

**VERMONT MUNICIPAL EMPLOYEES
INVESTMENT PERFORMANCE ANALYSIS
JUNE 30, 2005**

VERMONT MUNICIPAL EMPLOYEES
TOTAL FUND ASSET GROWTH SUMMARY (\$000)
PERIODS ENDING 6/05

MUNICIPAL SYSTEM COMPOSITE

	<u>LAST QUARTER</u>	<u>YEAR TO DATE</u>	<u>LAST 12 MONTHS</u>	<u>SINCE INCEPTION 3/01</u>
BEGINNING MARKET VALUE	238,815	239,747	220,726	163,148
NET EXTERNAL GROWTH	1,153	3,547	6,728	29,513
RETURN ON INVESTMENT	5,770	2,445	18,284	53,077
INCOME RECEIVED	484	1,321	7,938	18,399
GAIN/LOSS	5,286	1,123	10,346	34,678
ENDING MARKET VALUES	245,739	245,739	245,739	245,739

VERMONT MUNICIPAL EMPLOYEES
TOTAL FUND ASSET GROWTH SUMMARY (\$000)
PERIODS ENDING 6/05

DOMESTIC EQUITY COMPOSITE

	<u>LAST QUARTER</u>	<u>YEAR TO DATE</u>	<u>LAST 12 MONTHS</u>	<u>SINCE INCEPTION 3/01</u>
BEGINNING MARKET VALUE	102,212	107,767	99,540	65,832
NET EXTERNAL GROWTH	1,957	-92	1,819	18,438
RETURN ON INVESTMENT	3,413	-93	6,222	23,312
INCOME RECEIVED	231	459	5,073	7,823
GAIN/LOSS	3,183	-552	1,149	15,489
ENDING MARKET VALUES	107,582	107,582	107,582	107,582

VERMONT MUNICIPAL EMPLOYEES
TOTAL FUND ASSET GROWTH SUMMARY (\$000)
PERIODS ENDING 6/05

DELAWARE

	<u>LAST QUARTER</u>	<u>YEAR TO DATE</u>	<u>LAST 12 MONTHS</u>	<u>SINCE INCEPTION 6/00</u>
BEGINNING MARKET VALUE	41,437	41,975	39,060	24,252
NET EXTERNAL GROWTH	0	0	0	5,077
RETURN ON INVESTMENT	542	5	2,919	12,650
INCOME RECEIVED	231	459	879	3,092
GAIN/LOSS	312	-455	2,040	9,559
ENDING MARKET VALUES	41,980	41,980	41,980	41,980

VERMONT MUNICIPAL EMPLOYEES
TOTAL FUND ASSET GROWTH SUMMARY (\$000)
PERIODS ENDING 6/05

ALLIANCE LARGE CAP GROWTH FUND

	<u>LAST QUARTER</u>	<u>YEAR TO DATE</u>	<u>LAST 12 MONTHS</u>	<u>SINCE INCEPTION 6/00</u>
BEGINNING MARKET VALUE	37,116	39,569	36,310	35,650
NET EXTERNAL GROWTH	0	0	2,000	12,500
RETURN ON INVESTMENT	2,389	-64	1,195	-8,645
INCOME RECEIVED	0	0	0	17
GAIN/LOSS	2,389	-64	1,195	-8,662
ENDING MARKET VALUES	39,505	39,505	39,505	39,505

VERMONT MUNICIPAL EMPLOYEES
TOTAL FUND ASSET GROWTH SUMMARY (\$000)
PERIODS ENDING 6/05

LAZARD SMALL CAP FUND

	<u>LAST QUARTER</u>	<u>YEAR TO DATE</u>	<u>LAST 12 MONTHS</u>	<u>SINCE INCEPTION 6/00</u>
BEGINNING MARKET VALUE	23,659	26,223	24,171	13,335
NET EXTERNAL GROWTH	1,957	-92	-181	861
RETURN ON INVESTMENT	482	-33	2,108	11,902
INCOME RECEIVED	0	0	4,195	4,714
GAIN/LOSS	482	-33	-2,086	7,187
ENDING MARKET VALUES	26,098	26,098	26,098	26,098

VERMONT MUNICIPAL EMPLOYEES
TOTAL FUND ASSET GROWTH SUMMARY (\$000)
PERIODS ENDING 6/05

BRINSON - UBS

	<u>LAST QUARTER</u>	<u>YEAR TO DATE</u>	<u>LAST 12 MONTHS</u>	<u>SINCE INCEPTION 6/00</u>
BEGINNING MARKET VALUE	39,723	41,888	36,073	26,395
NET EXTERNAL GROWTH	0	- 2,000	- 2,000	6,453
RETURN ON INVESTMENT	- 375	- 540	5,275	6,500
INCOME RECEIVED	0	- 4	- 4	2
GAIN/LOSS	- 375	- 536	5,279	6,499
ENDING MARKET VALUES	39,348	39,348	39,348	39,348

VERMONT MUNICIPAL EMPLOYEES
TOTAL FUND ASSET GROWTH SUMMARY (\$000)
PERIODS ENDING 6/05

MET LIFE / SSR TOWER FUND

	<u>LAST QUARTER</u>	<u>YEAR TO DATE</u>	<u>LAST 12 MONTHS</u>	<u>SINCE INCEPTION 6/00</u>
BEGINNING MARKET VALUE	17, 003	14, 404	14, 125	11, 355
NET EXTERNAL GROWTH	- 49	1, 909	1, 826	1, 490
RETURN ON INVESTMENT	713	1, 354	1, 717	4, 822
INCOME RECEIVED	0	0	0	1, 399
GAIN/LOSS	713	1, 354	1, 717	3, 423
ENDING MARKET VALUES	17, 668	17, 668	17, 668	17, 668

VERMONT MUNICIPAL EMPLOYEES
TOTAL FUND ASSET GROWTH SUMMARY (\$000)
PERIODS ENDING 6/05

SEIX CORE

	<u>LAST QUARTER</u>	<u>YEAR TO DATE</u>	<u>LAST 12 MONTHS</u>	<u>SINCE INCEPTION 6/00</u>
BEGINNING MARKET VALUE	65,698	62,842	58,214	53,366
NET EXTERNAL GROWTH	0	3,000	5,000	-5,461
RETURN ON INVESTMENT	1,774	1,629	4,258	19,567
INCOME RECEIVED	547	960	1,931	7,297
GAIN/LOSS	1,226	670	2,327	12,270
ENDING MARKET VALUES	67,472	67,472	67,472	67,472

VERMONT MUNICIPAL EMPLOYEES
TOTAL FUND ASSET GROWTH SUMMARY (\$000)
PERIODS ENDING 6/05

SEIX HIGH YIELD

	<u>LAST QUARTER</u>	<u>YEAR TO DATE</u>	<u>LAST 12 MONTHS</u>	<u>SINCE INCEPTION 6/03</u>
BEGINNING MARKET VALUE	12,269	11,461	10,632	9,055
NET EXTERNAL GROWTH	- 17	967	937	1,882
RETURN ON INVESTMENT	347	170	1,030	1,662
INCOME RECEIVED	193	372	860	1,431
GAIN/LOSS	153	- 202	170	231
ENDING MARKET VALUES	12,598	12,598	12,598	12,598

VERMONT MUNICIPAL EMPLOYEES
TOTAL FUND ASSET GROWTH SUMMARY (\$000)
PERIODS ENDING 6/05

ALTERNATIVE INVESTMENTS

	<u>LAST QUARTER</u>	<u>YEAR TO DATE</u>	<u>LAST 12 MONTHS</u>	<u>SINCE INCEPTION 6/00</u>
BEGINNING MARKET VALUE	741	740	830	1,036
NET EXTERNAL GROWTH	0	0	80	80
RETURN ON INVESTMENT	-108	-108	-278	-484
INCOME RECEIVED	1	2	2	66
GAIN/LOSS	-109	-109	-280	-550
ENDING MARKET VALUES	632	632	632	632

VERMONT MUNICIPAL EMPLOYEES
TOTAL FUND ASSET GROWTH SUMMARY (\$000)
PERIODS ENDING 6/05

VERMONT INVESTMENTS

	<u>LAST QUARTER</u>	<u>YEAR TO DATE</u>	<u>LAST 12 MONTHS</u>	<u>SINCE INCEPTION 3/01</u>
BEGINNING MARKET VALUE	1, 170	645	1, 311	526
NET EXTERNAL GROWTH	- 738	- 238	- 934	- 399
RETURN ON INVESTMENT	6	31	61	311
INCOME RECEIVED	- 488	- 468	76	381
GAIN/LOSS	494	500	- 15	- 69
ENDING MARKET VALUES	438	438	438	438

VERMONT MUNICIPAL EMPLOYEES

PORTFOLIO ASSET GROWTH SUMMARY (\$000)

QUARTER ENDING 6/05

PORTFOLIO	BEGINNING VALUE	NET CONTR	INCOME RECEIVED	GAIN (LOSS)	END VALUE
MUNI COMPOSITE	238,815	1,153	484	5,286	245,739
EQTY COMPOSITE	102,212	1,957	231	3,183	107,582
DELAWARE	41,437	0	231	312	41,980
ALLIANCE	37,116	0	0	2,389	39,505
LAZARD	23,659	1,957	0	482	26,098
UBS	39,723	0	0	-375	39,348
SSR TOWER FUND	17,003	-49	0	713	17,668
SEIX CORE	65,698	0	547	1,226	67,472
SEIX HIGH YIELD	12,269	-17	193	153	12,598
ALT. ASSETS	741	0	1	-109	632
VERMONT INVEST	1,170	-738	-488	494	438

YEAR TO DATE

PORTFOLIO	BEGINNING VALUE	NET CONTR	INCOME RECEIVED	GAIN (LOSS)	END VALUE
MUNI COMPOSITE	239,747	3,547	1,321	1,123	245,739
EQTY COMPOSITE	107,767	-92	459	-552	107,582
DELAWARE	41,975	0	459	-455	41,980
ALLIANCE	39,569	0	0	-64	39,505
LAZARD	26,223	-92	0	-33	26,098
UBS	41,888	-2,000	-4	-536	39,348
SSR TOWER FUND	14,404	1,909	0	1,354	17,668
SEIX CORE	62,842	3,000	960	670	67,472
SEIX HIGH YIELD	11,461	967	372	-202	12,598
ALT. ASSETS	740	0	2	-109	632
VERMONT INVEST	645	-238	-468	500	438

VERMONT MUNICIPAL EMPLOYEES

PORTFOLIO ASSET GROWTH SUMMARY (\$000)

YEAR ENDING 6/05

PORTFOLIO	BEGINNING VALUE	NET CONTR	INCOME RECEIVED	GAIN (LOSS)	END VALUE
MUNI COMPOSITE	220,726	6,728	7,938	10,346	245,739
EQTY COMPOSITE	99,540	1,819	5,073	1,149	107,582
DELAWARE	39,060	0	879	2,040	41,980
ALLIANCE	36,310	2,000	0	1,195	39,505
LAZARD	24,171	-181	4,195	-2,086	26,098
UBS	36,073	-2,000	-4	5,279	39,348
SSR TOWER FUND	14,125	1,826	0	1,717	17,668
SEIX CORE	58,214	5,000	1,931	2,327	67,472
SEIX HIGH YIELD	10,632	937	860	170	12,598
ALT. ASSETS	830	80	2	-280	632
VERMONT INVEST	1,311	-934	76	-15	438

VERMONT MUNICIPAL EMPLOYEES

ASSET ALLOCATION SUMMARY

AS OF 6/05

	MARKET VALUE (\$000)	COMMON STOCK	INT'L COMMON STOCK	BONDS	INT'L BONDS	CONV	CASH EQUIV	MORT	REAL ESTATE	SV ASSETS	PRVT INVEST	HEDGE FUNDS
** TOTAL FUND **												
MUNI COMPOSITE	245,739	43.6	16.0	32.7			0.3		7.2		0.2	
MEDIAN		47.0	10.6	28.6	0.0		1.9		0.0		0.0	0.0
** EQUITY MANAGERS **												
EQTY COMPOSITE	107,582	99.7					0.3					
DELAWARE	41,980	99.2					0.8					
ALLIANCE	39,505	100.0										
LAZARD	26,098	100.0										
MEDIAN		99.3										
** BOND MANAGERS **												
SEIX CORE	67,472			100.0								
SEIX HIGH YIELD	12,598			100.0								
MEDIAN				99.6								

VERMONT MUNICIPAL EMPLOYEES

ASSET ALLOCATION SUMMARY

AS OF 6/05

	MARKET VALUE (\$000)	COMMON STOCK	INT'L COMMON STOCK	BONDS	INT'L BONDS	CONV	CASH EQUIV	MORT	REAL ESTATE	SV ASSETS	PRVT INVEST	HEDGE FUNDS
** CASH EQUIV MANAGERS **												
VERMONT INVEST	438			71.1			28.9					
MEDIAN												
** INT'L DEVELOPED MKT EQUITY MANAGERS **												
UBS	39,348		100.0				0.0					
MEDIAN												
** REAL ESTATE MANAGERS **												
SSR TOWER FUND	17,668								100.0			
MEDIAN												
** PRIVATE EQUITY MANAGERS **												
ALT. ASSETS	632						25.3				74.7	
MEDIAN												

VERMONT MUNICIPAL EMPLOYEES
ASSET ALLOCATION ANALYSIS
AS OF JUNE 30, 2005

DELAWARE

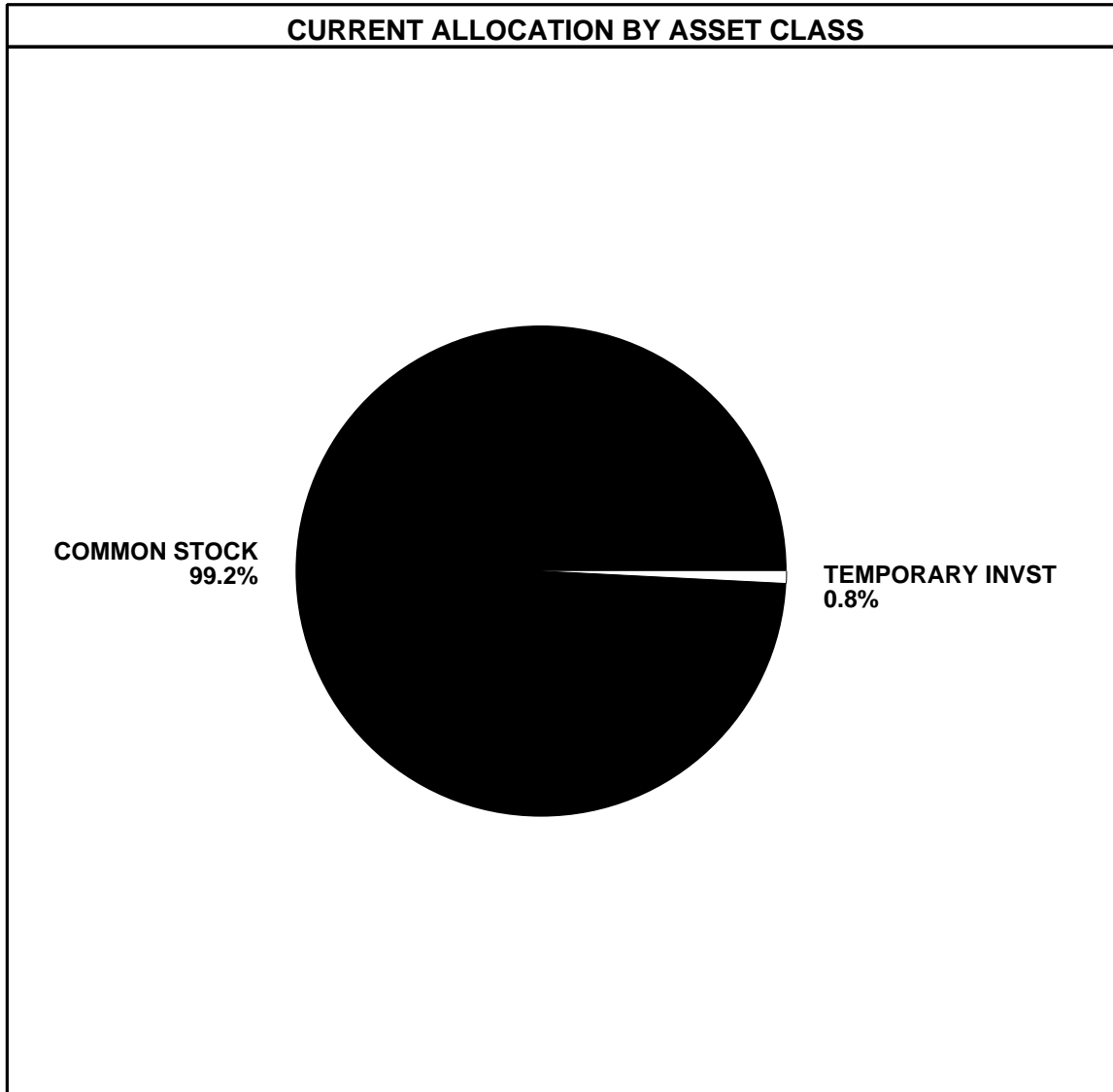

<u>ASSET CLASS</u>	<u>CURRENT DOLLARS</u>	<u>CURRENT %</u>
COMMON STOCK	41,662,673	99.2
TEMPORARY INVST	<u>316,968</u>	<u>0.8</u>
TOTAL	41,979,641	100.0

VERMONT MUNICIPAL EMPLOYEES
ASSET ALLOCATION ANALYSIS
AS OF JUNE 30, 2005

ALLIANCE LARGE CAP GROWTH FUND

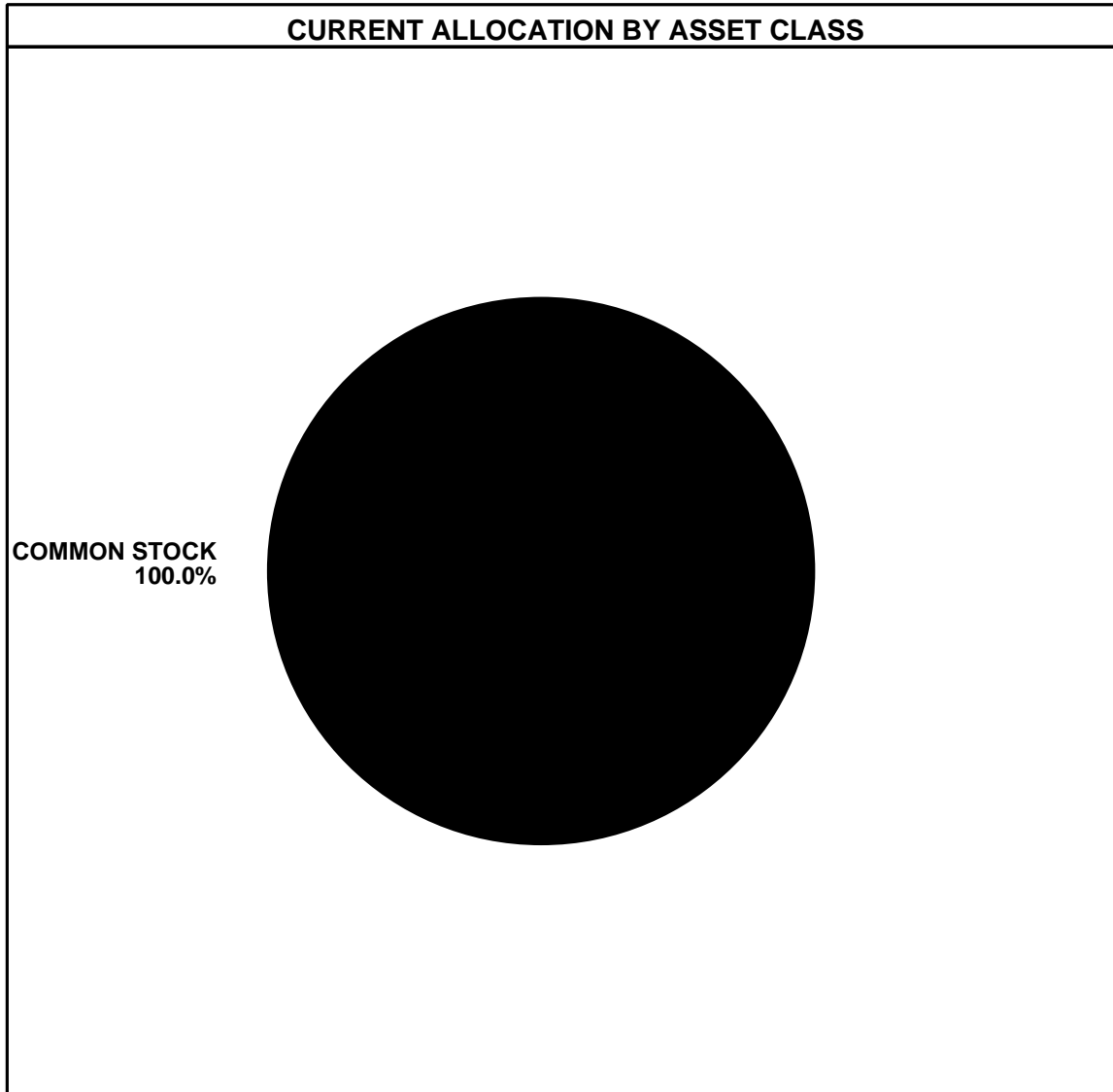

<u>ASSET CLASS</u>	<u>CURRENT DOLLARS</u>	<u>CURRENT %</u>
COMMON STOCK	<u>39,504,571</u>	<u>100.0</u>
TOTAL	39,504,571	100.0

VERMONT MUNICIPAL EMPLOYEES
ASSET ALLOCATION ANALYSIS
AS OF JUNE 30, 2005

LAZARD SMALL CAP FUND

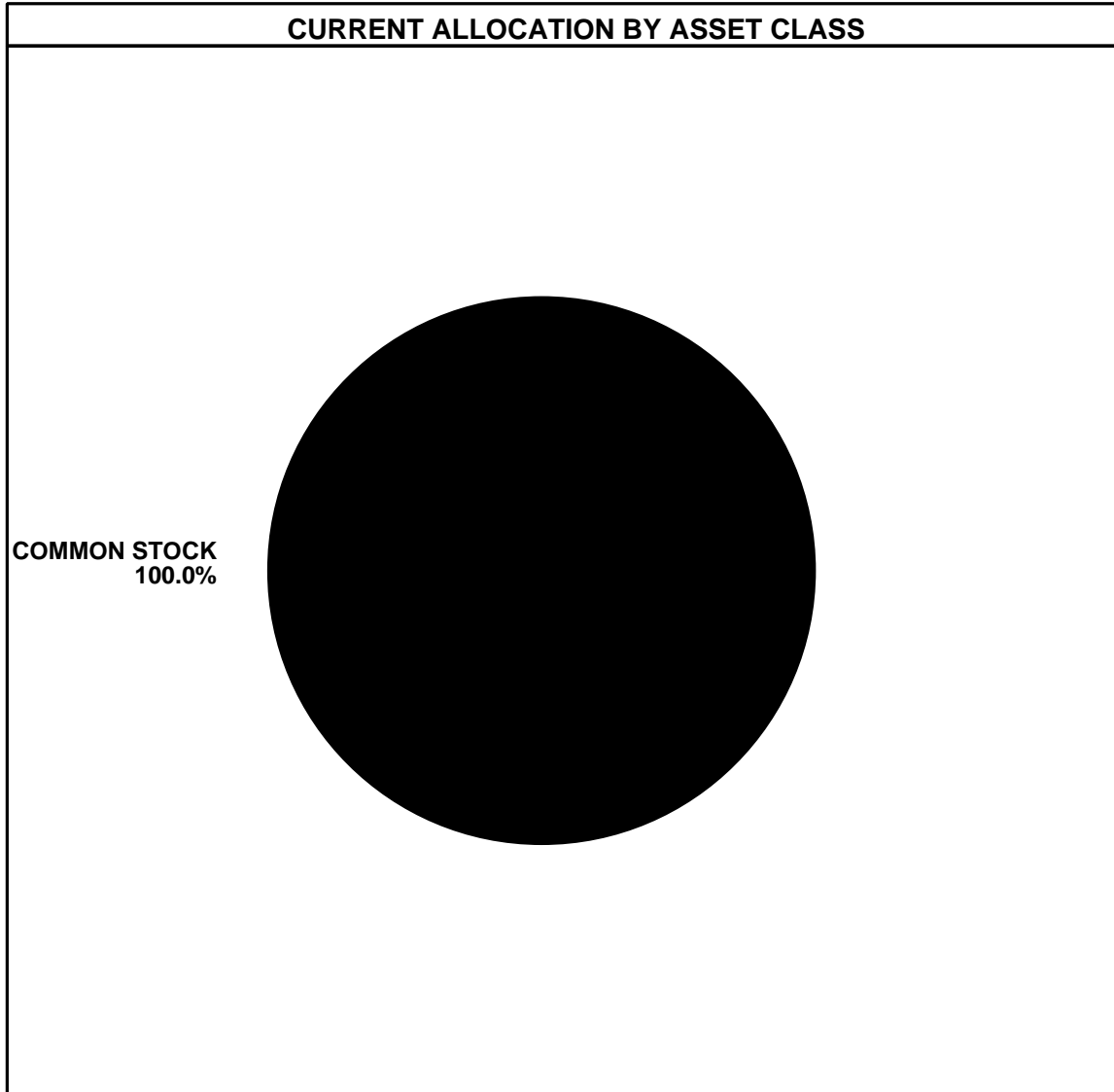

<u>ASSET CLASS</u>	<u>CURRENT DOLLARS</u>	<u>CURRENT %</u>
COMMON STOCK	<u>26,097,550</u>	<u>100.0</u>
TOTAL	26,097,550	100.0

VERMONT MUNICIPAL EMPLOYEES
ASSET ALLOCATION ANALYSIS
AS OF JUNE 30, 2005

BRINSON - UBS

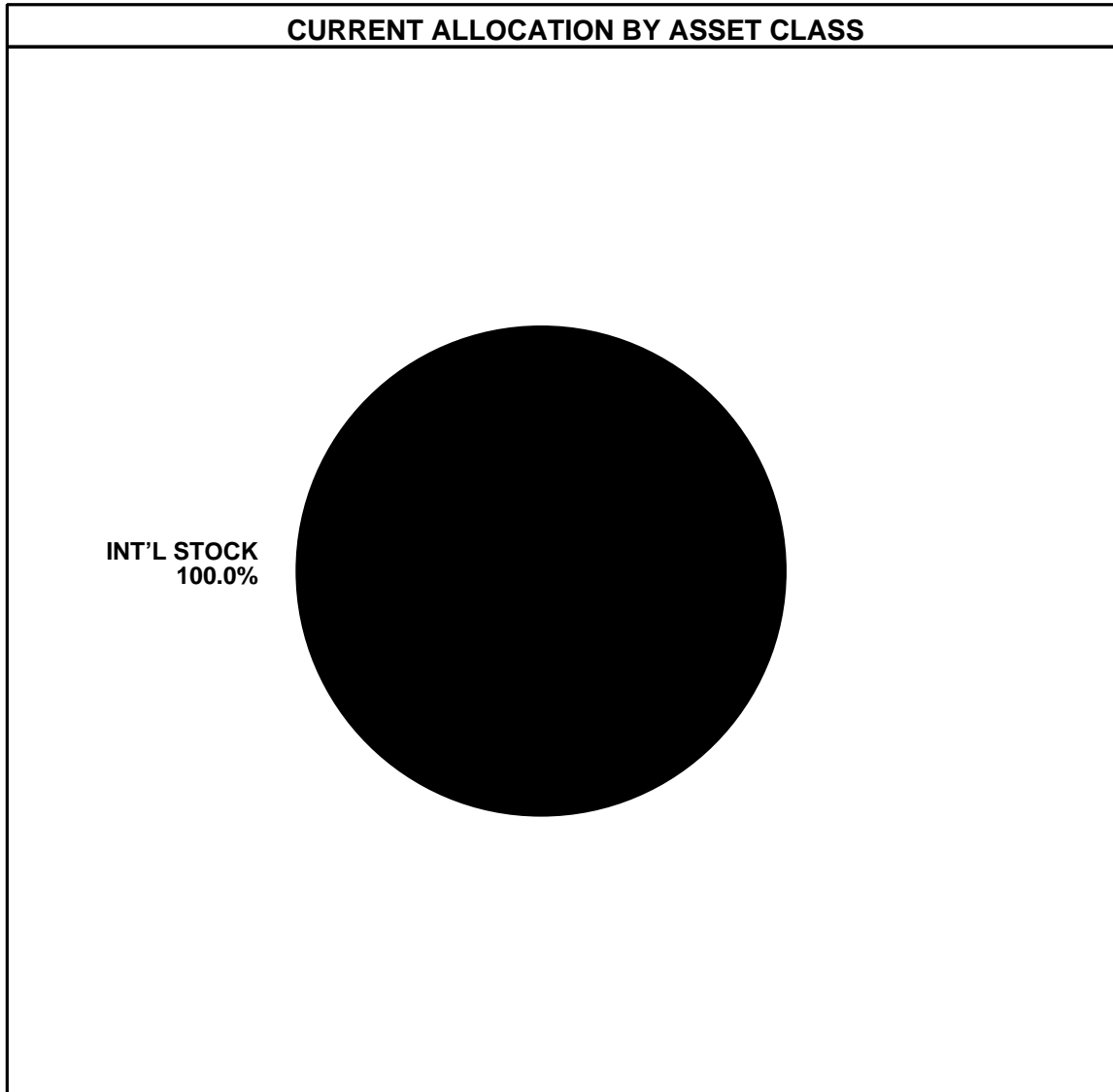

<u>ASSET CLASS</u>	<u>CURRENT DOLLARS</u>	<u>CURRENT %</u>
INT'L STOCK	39,340,213	100.0
TEMPORARY INVST	<u>8,072</u>	<u>0.0</u>
TOTAL	39,348,285	100.0

VERMONT MUNICIPAL EMPLOYEES
ASSET ALLOCATION ANALYSIS
AS OF JUNE 30, 2005

SEIX CORE

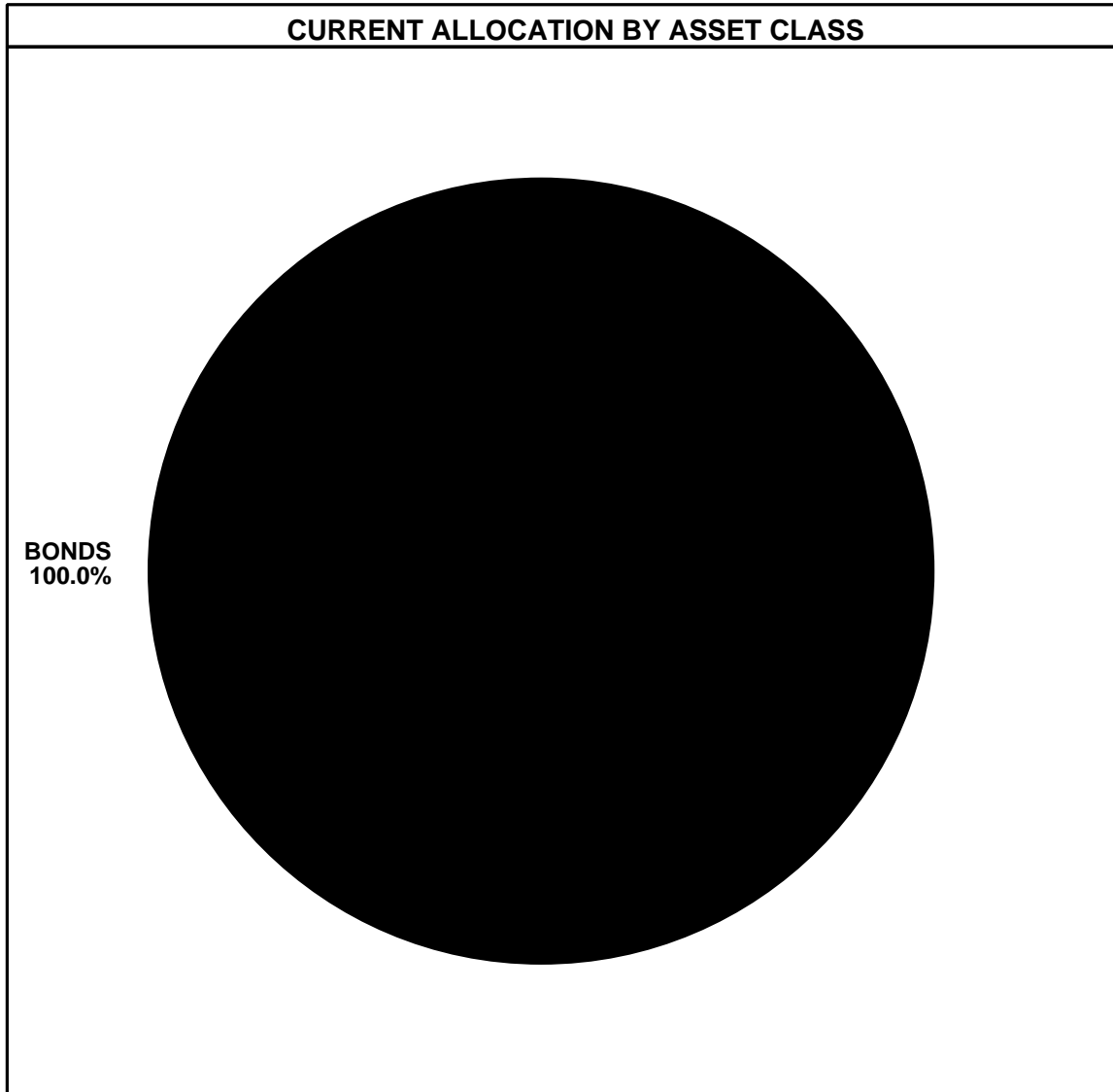

<u>ASSET CLASS</u>	<u>CURRENT DOLLARS</u>	<u>CURRENT %</u>
BONDS	<u>67,471,617</u>	<u>100.0</u>
TOTAL	67,471,617	100.0

VERMONT MUNICIPAL EMPLOYEES
ASSET ALLOCATION ANALYSIS
AS OF JUNE 30, 2005

SEIX HIGH YIELD

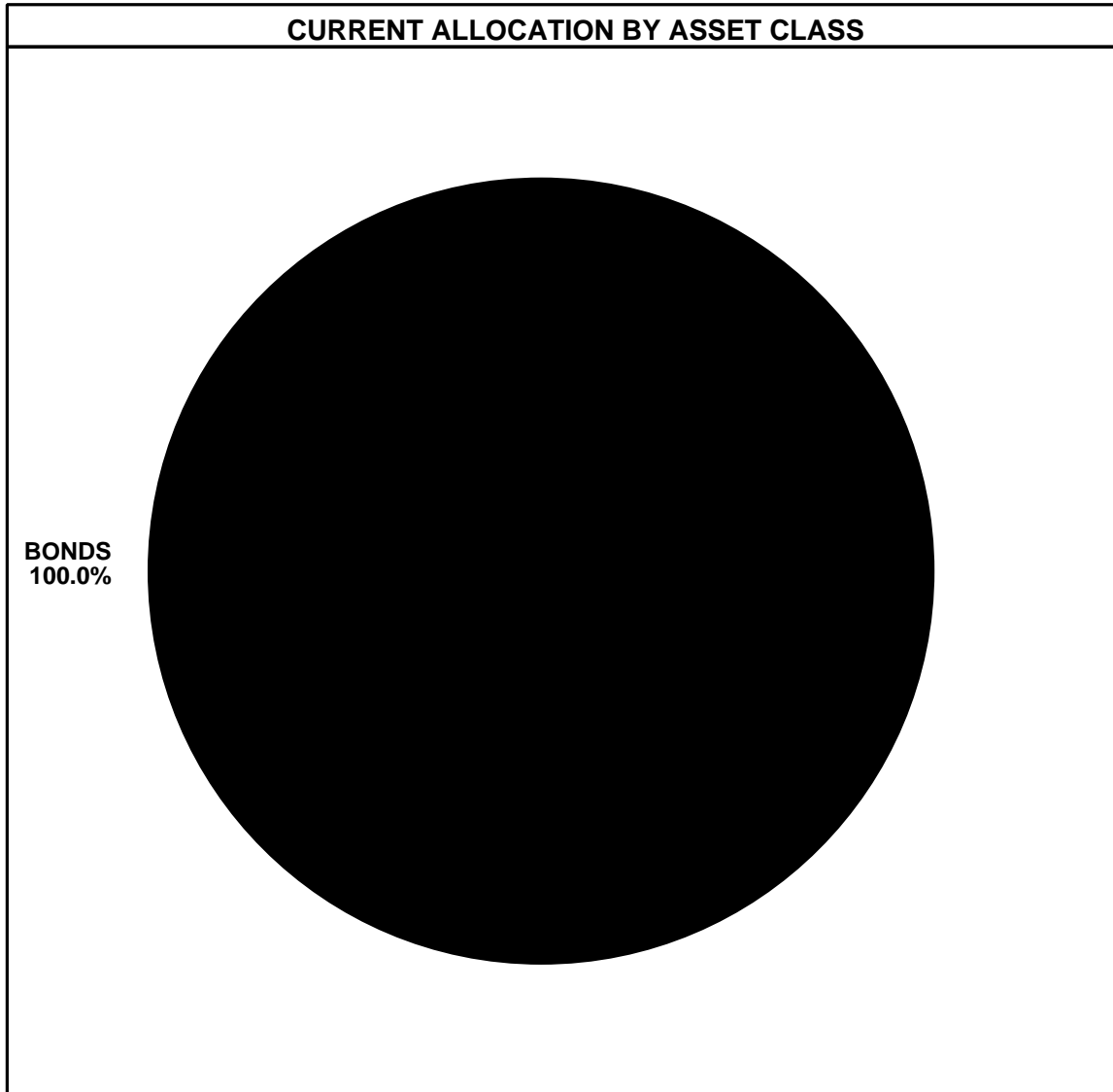

<u>ASSET CLASS</u>	<u>CURRENT DOLLARS</u>	<u>CURRENT %</u>
BONDS	<u>12,598,449</u>	<u>100.0</u>
TOTAL	12,598,449	100.0

VERMONT MUNICIPAL EMPLOYEES
ASSET ALLOCATION ANALYSIS
AS OF JUNE 30, 2005

MUNICIPAL SYSTEM COMPOSITE

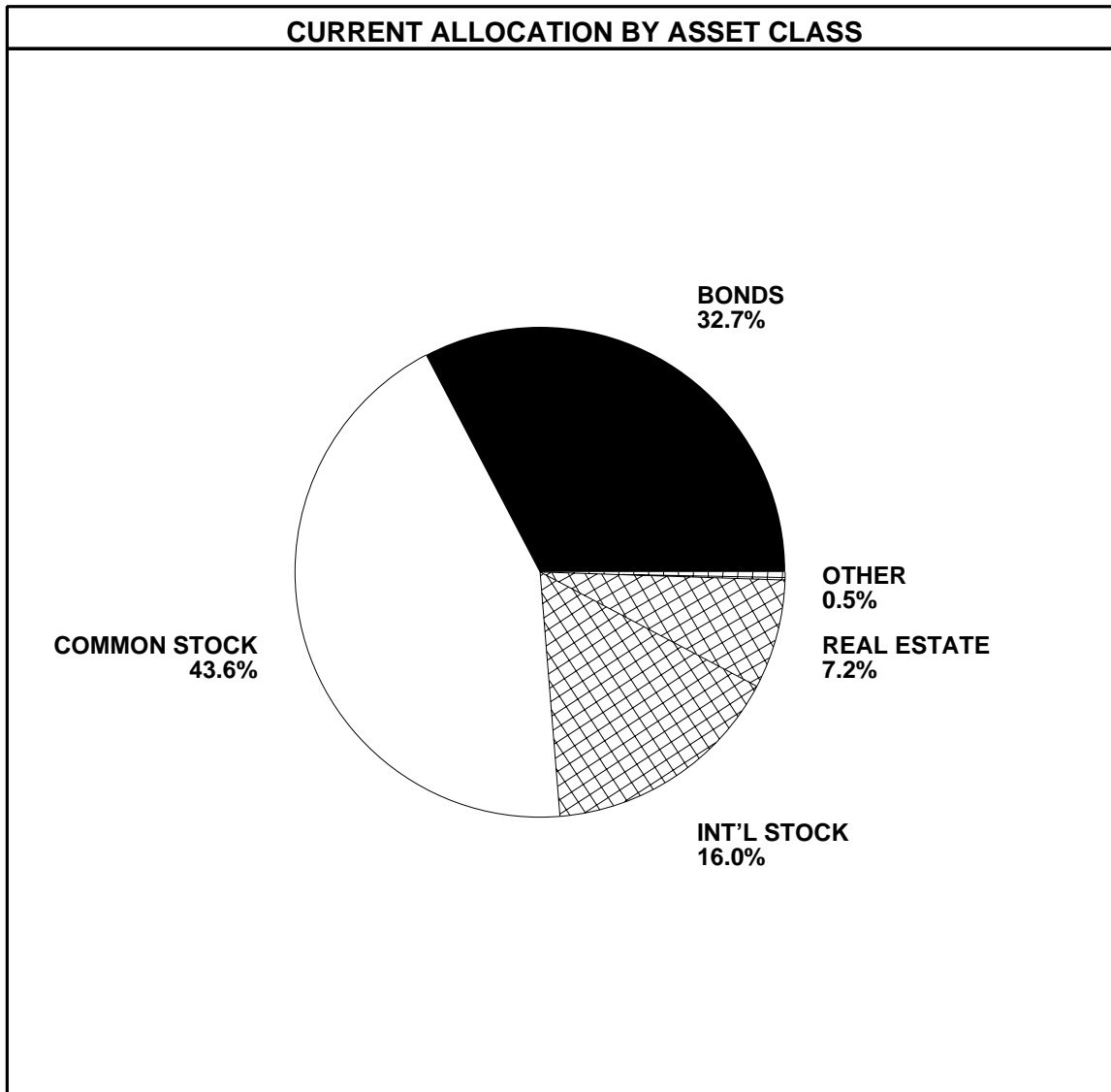

<u>ASSET CLASS</u>	<u>CURRENT DOLLARS</u>	<u>CURRENT %</u>
COMMON STOCK	107,264,794	43.6
INT'L STOCK	39,340,213	16.0
TEMPORARY INVST	612,042	0.3
BONDS	80,381,779	32.7
REAL ESTATE	17,667,544	7.2
PRIVATE INVEST	472,146	0.2
TOTAL	245,738,518	100.0

VERMONT MUNICIPAL EMPLOYEES
ASSET ALLOCATION ANALYSIS
AS OF JUNE 30, 2005

DOMESTIC EQUITY COMPOSITE

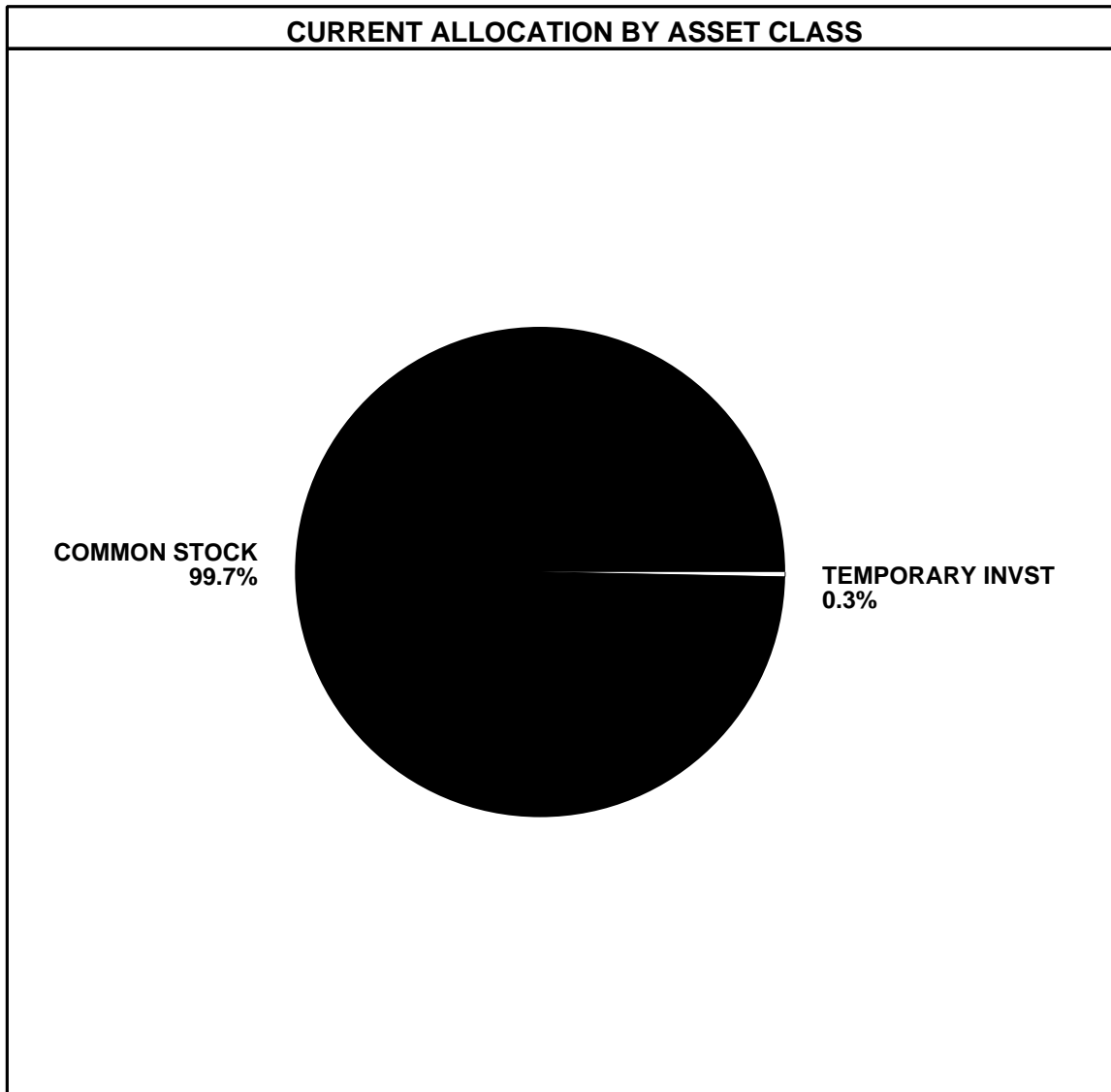

<u>ASSET CLASS</u>	<u>CURRENT DOLLARS</u>	<u>CURRENT %</u>
COMMON STOCK	107,264,794	99.7
TEMPORARY INVST	<u>316,968</u>	<u>0.3</u>
TOTAL	107,581,762	100.0

VERMONT MUNICIPAL EMPLOYEES
ALLOCATION BY MANAGER TYPE ANALYSIS
AS OF JUNE 30, 2005

MUNICIPAL SYSTEM COMPOSITE

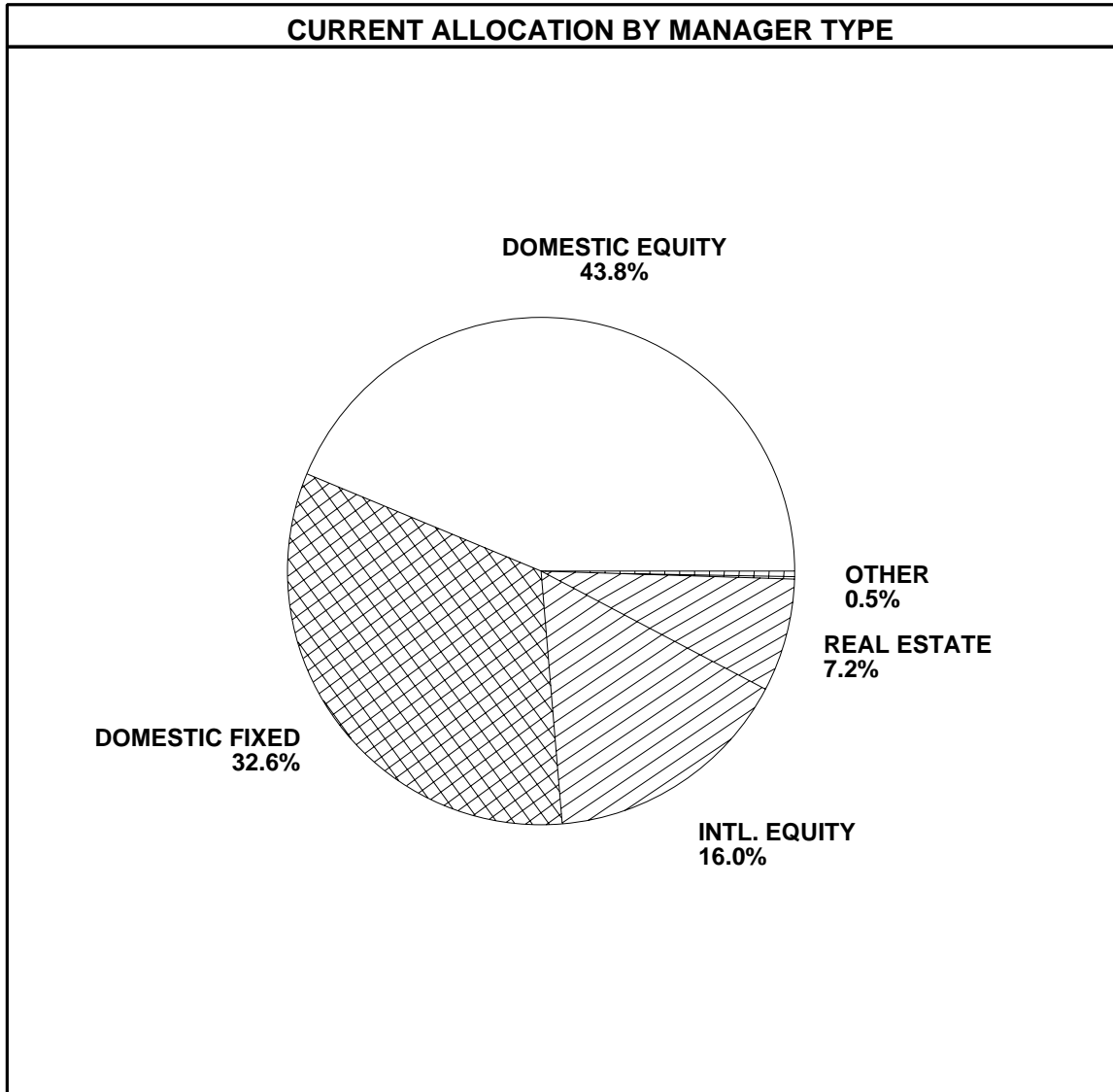

<u>MANAGER TYPE</u>	<u>CURRENT DOLLARS</u>	<u>CURRENT %</u>
CASH	438,447	0.2
DOMESTIC EQUITY	107,581,762	43.8
INTL. EQUITY	39,348,285	16.0
DOMESTIC FIXED	80,070,066	32.6
REAL ESTATE	17,667,544	7.2
PRIVATE EQUITY	632,414	0.3
TOTAL	245,738,518	100.0

VERMONT MUNICIPAL EMPLOYEES
MANAGER ALLOCATION ANALYSIS
AS OF JUNE 30, 2005

MUNICIPAL SYSTEM COMPOSITE

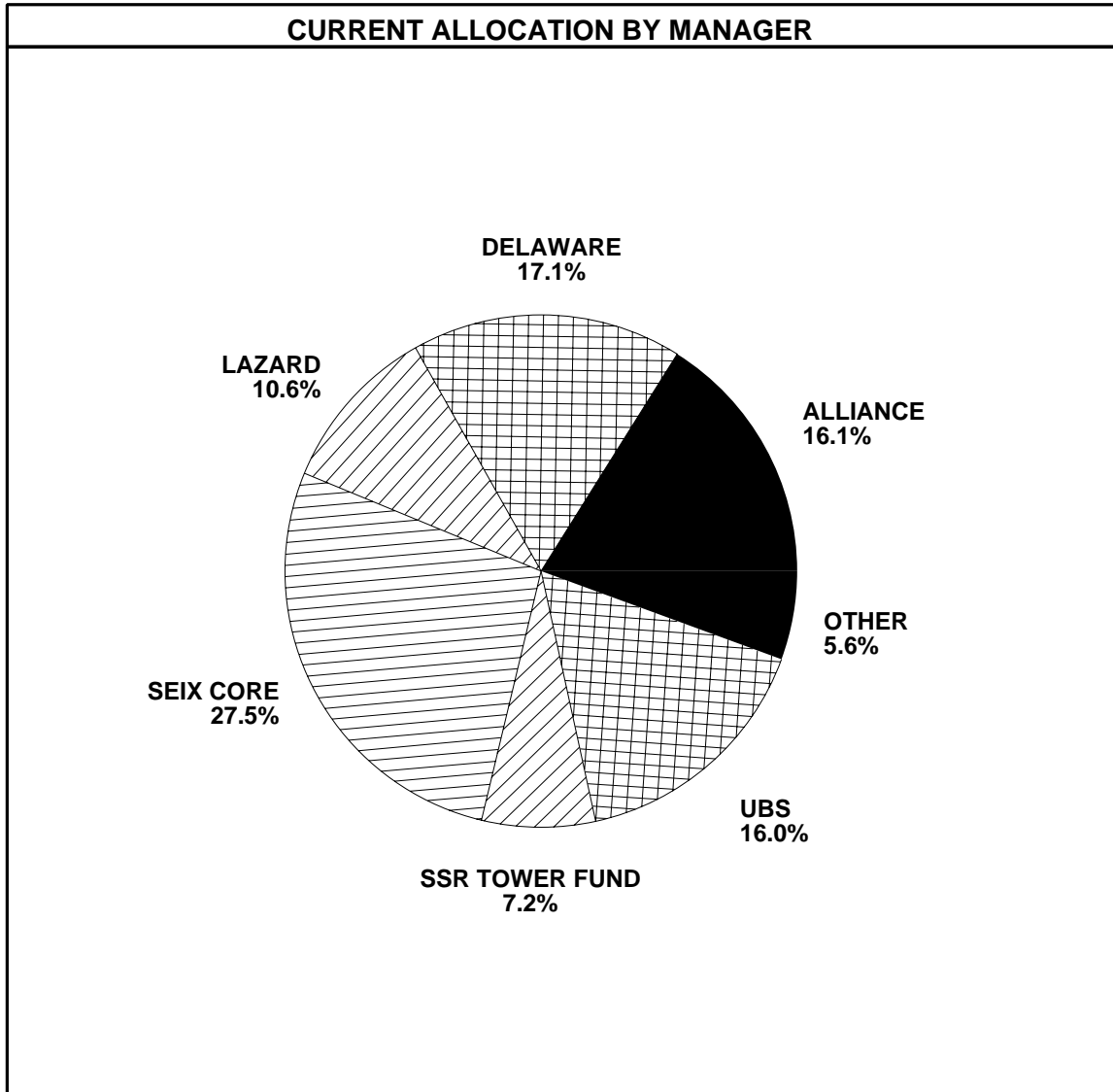

<u>MANAGER</u>	<u>CURRENT DOLLARS</u>	<u>CURRENT %</u>
ALLIANCE	0	0.0
ALLIANCE	39,504,571	16.1
ALT. ASSETS	632,414	0.3
DELAWARE	41,979,641	17.1
LAZARD	26,097,550	10.6
LOOMIS	0	0.0
SEIX CORE	67,471,617	27.5
SEIX HIGH YIELD	12,598,449	5.1
SSR TOWER FUND	17,667,544	7.2
UBS	39,348,285	16.0
VERMONT INVEST	<u>438,447</u>	<u>0.2</u>
TOTAL	245,738,518	100.0

VERMONT MUNICIPAL EMPLOYEES
MANAGER ALLOCATION ANALYSIS
AS OF JUNE 30, 2005

DOMESTIC EQUITY COMPOSITE

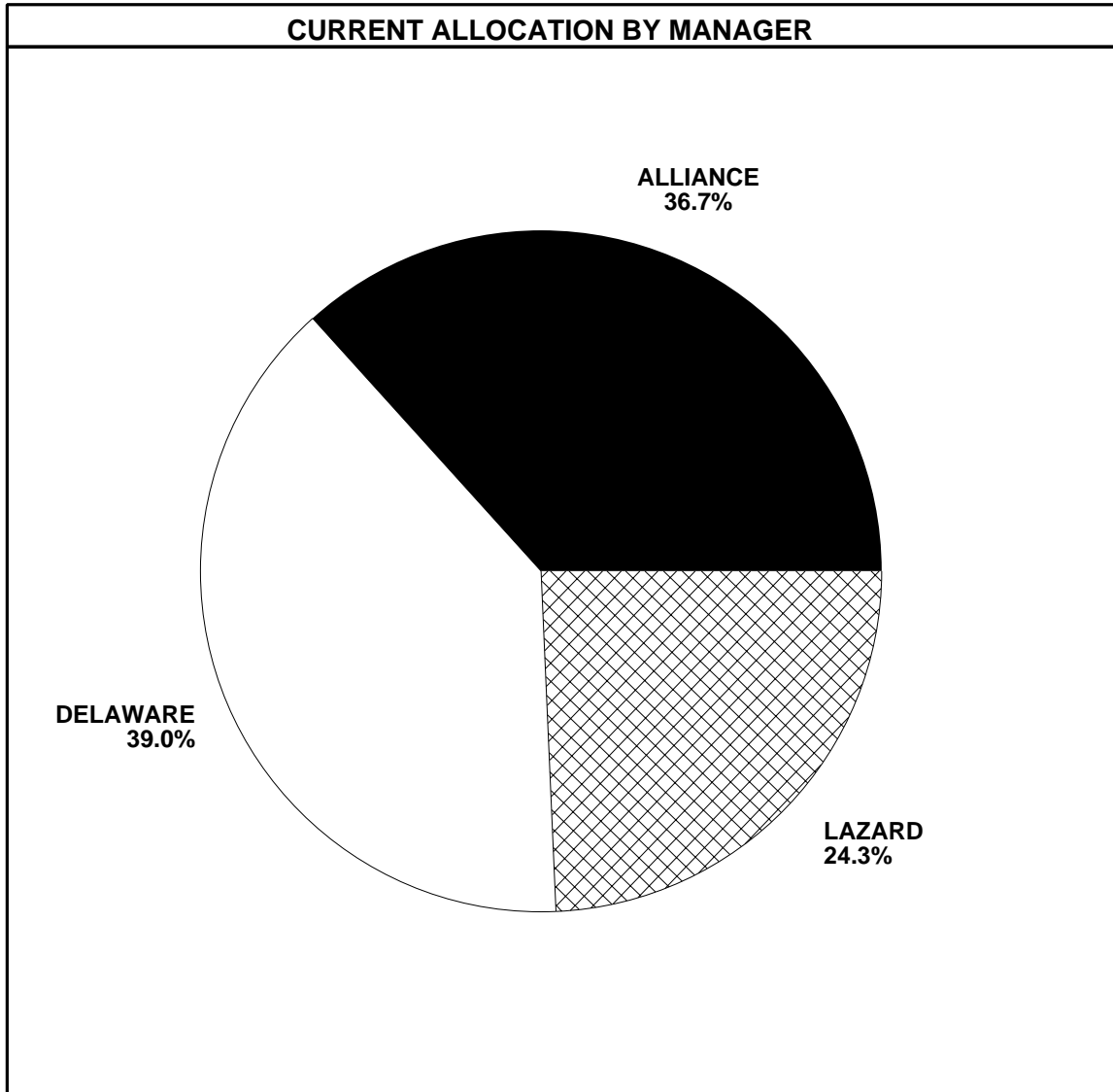

<u>MANAGER</u>	<u>CURRENT DOLLARS</u>	<u>CURRENT %</u>
ALLIANCE	39,504,571	36.7
DELAWARE	41,979,641	39.0
LAZARD	26,097,550	24.3
TOTAL	107,581,762	100.0

VERMONT MUNICIPAL EMPLOYEES

TOTAL FUNDS - EQUITY COMMITMENT

ASSET ALLOCATION HISTORY

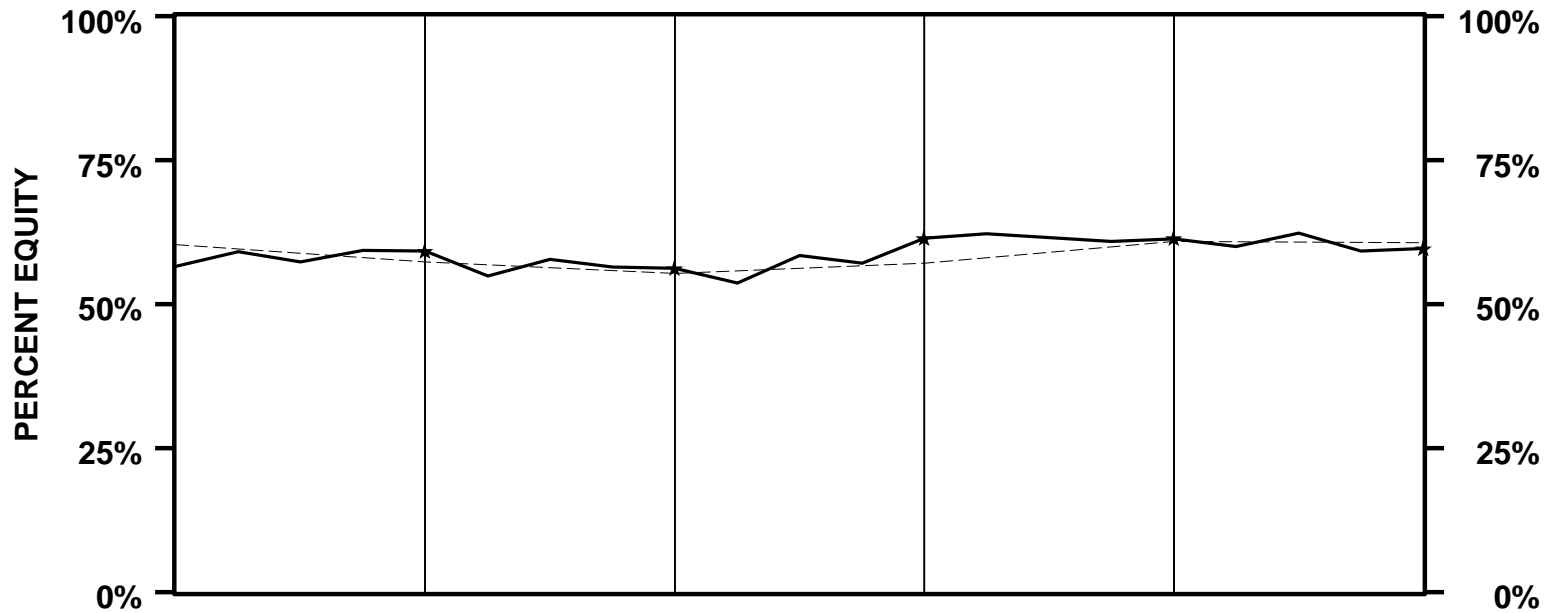

	6/00	6/01	6/02	6/03	6/04	6/05
HIGH	84.5	83.8	79.4	81.6	81.0	79.3
1ST QTL	68.2	65.3	63.0	65.1	67.7	67.3
■ MEDIAN	60.4	57.4	55.3	57.1	60.9	60.7
3RD QTL	47.6	45.1	42.9	46.3	50.2	48.6
LOW	0.0	0.0	0.0	0.0	0.0	0.0
★ MUNI COMPOSITE	56.6	59.2	56.2	61.5	61.4	59.7

* Includes International Segment

VERMONT MUNICIPAL EMPLOYEES

TOTAL FUNDS - BOND COMMITMENT

ASSET ALLOCATION HISTORY

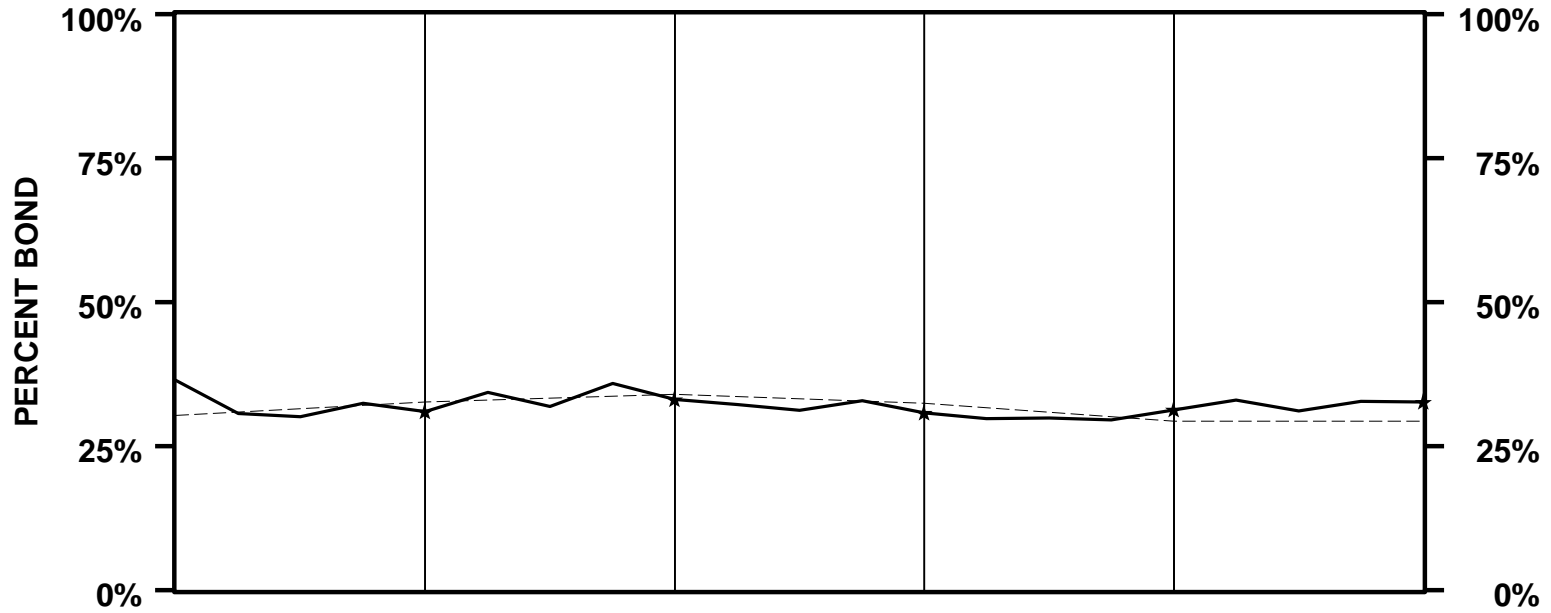

	6/00	6/01	6/02	6/03	6/04	6/05
HIGH	79.1	75.9	75.7	76.1	73.5	72.6
1ST QTL	39.1	41.1	42.8	41.6	37.3	37.0
■ MEDIAN	30.3	32.7	34.0	32.4	29.3	29.3
3RD QTL	19.7	21.7	22.7	23.7	20.2	19.6
LOW	0.0	0.0	0.0	0.0	0.0	0.0
★ MUNI COMPOSITE	36.5	31.0	33.1	30.8	31.3	32.7

* Includes International Segment

VERMONT MUNICIPAL EMPLOYEES

EQUITY FUNDS - EQUITY COMMITMENT

ASSET ALLOCATION HISTORY

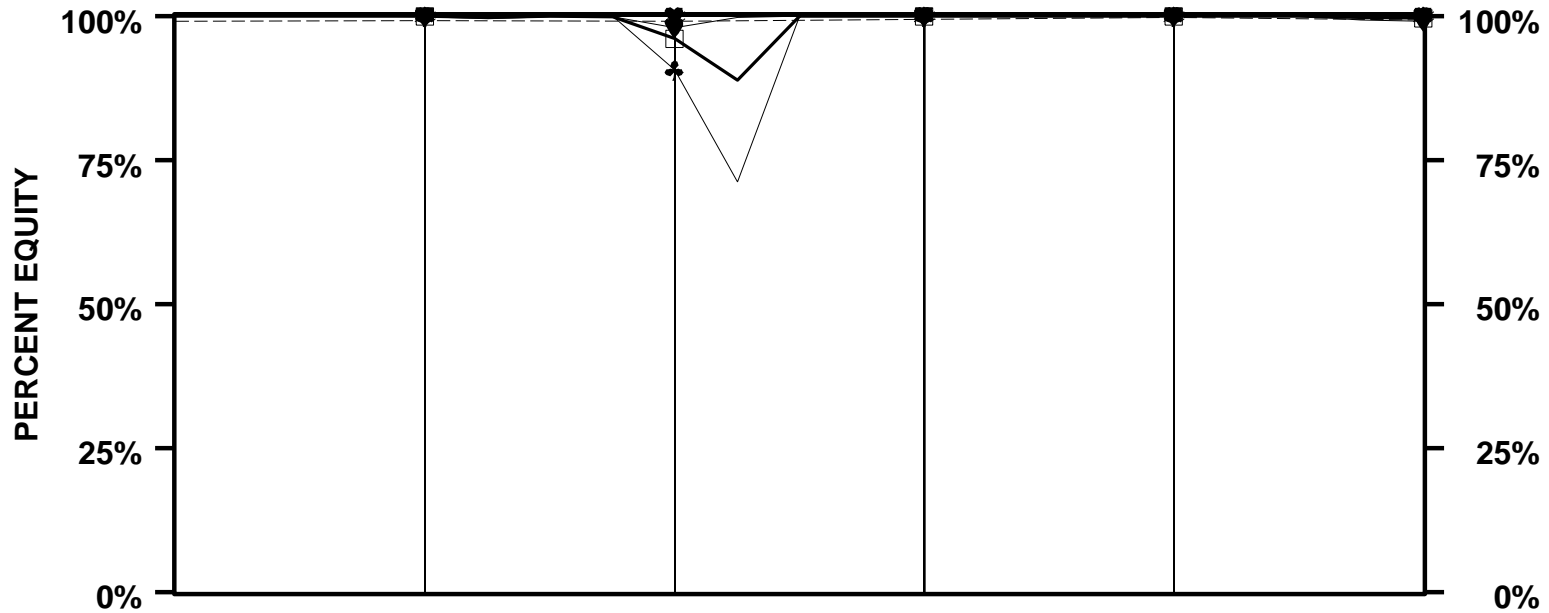

	6/00		6/01		6/02		6/03		6/04		6/05	
HIGH	100.0		100.0		100.0		100.0		100.0		100.0	
1ST QTL	100.0		100.0		100.0		100.0		100.0		100.0	
MEDIAN	99.1		99.3		99.2		99.5		99.8		99.4	
3RD QTL	95.7		96.0		96.0		96.5		97.2		96.7	
LOW	0.0		1.0		21.4		60.7		65.2		0.0	
EQTY COMPOSITE	100.0	1	100.0	41	96.1	74	100.0	1	100.0	1	99.7	46
DELAWARE	100.0	1	99.9	42	98.0	60	100.0	1	100.0	1	99.2	51
ALLIANCE	100.0	1	100.0	41	90.7	89	100.0	1	100.0	1	100.0	1
LAZARD	100.0	1	100.0	1	100.0	1	100.0	1	100.0	1	100.0	1
UBS	100.0	1	100.0	1	100.0	41	100.0	34	100.0	47	100.0	25

* Includes International Segment

VERMONT MUNICIPAL EMPLOYEES

BOND FUNDS - BOND COMMITMENT

ASSET ALLOCATION HISTORY

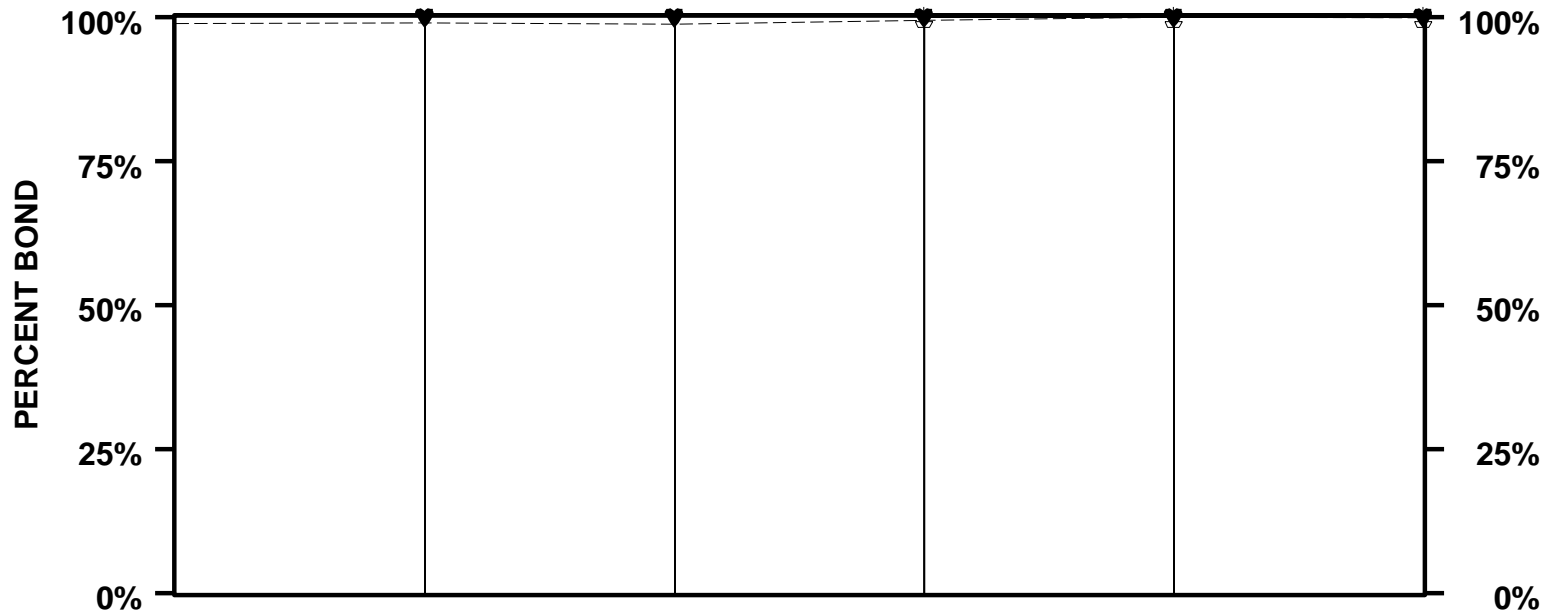

	<u>6/00</u>		<u>6/01</u>		<u>6/02</u>		<u>6/03</u>		<u>6/04</u>		<u>6/05</u>	
HIGH	100.0		100.0		100.0		100.0		100.0		100.0	
1ST QTL	100.0		100.0		100.0		100.0		100.0		100.0	
■ MEDIAN	98.9		99.0		98.8		99.5		100.0		99.9	
3RD QTL	93.4		93.3		92.7		92.8		95.2		95.2	
LOW	0.0		0.0		0.0		0.0		0.0		0.0	
♥ SEIX CORE	100.0	1	100.0	1	100.0	1	100.0	1	100.0	1	100.0	1
⊕ SEIX HIGH YIELD							100.0	1	100.0	1	100.0	1

* Includes International Segment

VERMONT MUNICIPAL EMPLOYEES

PERFORMANCE SUMMARY

PERIODS ENDING 6/05

	<u>LAST QTR</u>		<u>LAST 2 QTRS</u>		<u>LAST 3 QTRS</u>		<u>LAST YEAR</u>		<u>LAST 3 YEARS</u>		<u>LAST 5 YEARS</u>	
** TOTAL FUND **												
MUNI COMPOSITE	2.4	34	1.0	63	8.1	62	8.1	61	8.2	71	4.6	37
ALLOC INDEX	2.3	40	1.0	60	9.1	41	9.5	35	9.6	39	3.0	70
POLICY INDEX	2.2	42	0.9	67	8.5	55	9.1	43	9.3	47	3.3	66
MEDIAN	2.1		1.2		8.8		8.8		9.2		3.9	
** EQUITY MANAGERS **												
EQTY COMPOSITE	3.3	32	0.0	57	9.7	64	6.1	74	7.7	83	1.8	53
DELAWARE	1.3	79	0.0	56	8.7	72	7.5	57	8.2	78	7.3	35
ALLIANCE	6.4	4	-0.2	59	9.1	69	2.8	90	5.1	95	-8.4	95
LAZARD	2.0	59	0.1	54	12.1	44	9.0	48	11.4	43	12.3	20
S&P 500	1.4	76	-0.8	75	8.3	79	6.3	72	8.3	77	-2.4	77
R 1000(R) GR	2.5	49	-1.7	84	7.3	87	1.7	93	7.3	86	-10.4	97
R 1000(R) VALUE	1.7	66	1.8	29	12.3	42	14.1	17	11.0	46	6.6	38
R 2000(R)	4.3	18	-1.3	81	12.7	38	9.4	46	12.8	31	5.7	42
MEDIAN	2.4		0.3		11.5		8.6		10.6		3.1	

VERMONT MUNICIPAL EMPLOYEES

PERFORMANCE SUMMARY

PERIODS ENDING 6/05

	<u>LAST QTR</u>		<u>LAST 2 QTRS</u>		<u>LAST 3 QTRS</u>		<u>LAST YEAR</u>		<u>LAST 3 YEARS</u>		<u>LAST 5 YEARS</u>	
** BOND MANAGERS **												
SEIX CORE	2.7	55	2.4	51	3.4	64	7.0	49	5.9	60	7.2	66
SEIX HIGH YIELD	2.8	50	1.3	82	4.3	32	9.5	10				
LB AGGREGATE	3.0	40	2.5	45	3.5	58	6.8	56	5.8	64	7.4	60
ML HIGH YLD II	2.6	58	1.1	85	5.7	7	10.6	5	14.2	1	7.1	67
MEDIAN	2.8		2.5		3.7		7.0		6.3		7.7	
** CASH EQUIV MANAGERS **												
VERMONT INVEST	0.5	86	2.3	7	3.4	9	4.3	9	2.5	12	3.7	13
90 DAY T-BILLS	0.7	40	1.3	41	1.8	36	2.2	36	1.6	44	2.6	55
MEDIAN	0.7		1.3		1.7		2.0		1.5		2.7	
** INT'L DEVELOPED MKT EQUITY MANAGERS **												
UBS	-1.0	70	-1.3	77	12.8	74	14.6	54	11.3	69	3.0	49
MS EAFE NET	-1.0	72	-1.2	73	14.0	59	13.7	60	12.1	62	-0.5	76
CITI PMI EPAC	-0.6	58	-0.7	61	14.7	46	14.7	54	12.5	59	0.0	72
MEDIAN	-0.4		0.0		14.5		15.2		13.3		3.0	

VERMONT MUNICIPAL EMPLOYEES

PERFORMANCE SUMMARY

PERIODS ENDING 6/05

	<u>LAST QTR</u>		<u>LAST 2 QTRS</u>		<u>LAST 3 QTRS</u>		<u>LAST YEAR</u>		<u>LAST 3 YEARS</u>		<u>LAST 5 YEARS</u>	
** REAL ESTATE MANAGERS **												
SSR TOWER FUND	4.2	44	8.8	33	11.4	57	11.6	70	7.8	71	7.3	69
NCREIF CL PROP	3.5	57	7.1	53	11.1	58	14.9	61	10.0	63	9.2	59
MEDIAN	3.9		7.7		12.9		16.8		11.7		10.0	
** PRIVATE EQUITY MANAGERS **												
ALT. ASSETS	-14.6	97	-14.5	95	-30.5	97	-30.5	95	-13.4	88	-11.1	91
MEDIAN	0.0		2.5		5.9		9.4		4.8		1.2	

VERMONT MUNICIPAL EMPLOYEES

PERFORMANCE SUMMARY NET OF FEES

PERIODS ENDING 6/05

	LAST QTR	LAST 2 QTRS	LAST 3 QTRS	LAST YEAR	LAST 3 YEARS	LAST 5 YEARS
** TOTAL FUND **						
MUNI COMPOSITE	2.3	0.9	8.0	7.9	8.0	
ALLOC INDEX	2.3	1.0	9.1	9.5	9.6	3.0
POLICY INDEX	2.2	0.9	8.5	9.1	9.3	3.3
** EQUITY MANAGERS **						
EQTY COMPOSITE	3.3	- 0.1	9.5	5.9	7.5	
DELAWARE	1.3	0.0	8.7	7.5	8.2	
ALLIANCE	6.4	- 0.2	9.1	2.8	5.1	
LAZARD	1.8	- 0.3	11.4	8.2	10.5	
S&P 500	1.4	- 0.8	8.3	6.3	8.3	- 2.4
R 1000(R) GR	2.5	- 1.7	7.3	1.7	7.3	- 10.4
R 1000(R) VALUE	1.7	1.8	12.3	14.1	11.0	6.6
R 2000(R)	4.3	- 1.3	12.7	9.4	12.8	5.7
** BOND MANAGERS **						
SEIX CORE	2.7	2.4	3.4	7.0	5.9	
SEIX HIGH YIELD	2.7	1.0	3.8	8.8		
LB AGGREGATE	3.0	2.5	3.5	6.8	5.8	7.4
ML HIGH YLD II	2.6	1.1	5.7	10.6	14.2	7.1
** CASH EQUIV MANAGERS **						
VERMONT INVEST	0.5	2.3	3.4	4.3	2.5	

VERMONT MUNICIPAL EMPLOYEES

PERFORMANCE SUMMARY NET OF FEES

PERIODS ENDING 6/05

	<u>LAST QTR</u>	<u>LAST 2 QTRS</u>	<u>LAST 3 QTRS</u>	<u>LAST YEAR</u>	<u>LAST 3 YEARS</u>	<u>LAST 5 YEARS</u>
** CASH EQUIV MANAGERS **						
<i>90 DAY T-BILLS</i>	0.7	1.3	1.8	2.2	1.6	2.6
** INT'L DEVELOPED MKT EQUITY MANAGERS **						
<i>UBS</i>	- 1.0	- 1.3	12.8	14.6	11.3	
<i>MS EAFE NET</i>	- 1.0	- 1.2	14.0	13.7	12.1	- 0.5
<i>CITI PMI EPAC</i>	- 0.6	- 0.7	14.7	14.7	12.5	0.0
** REAL ESTATE MANAGERS **						
<i>SSR TOWER FUND</i>	3.9	8.2	10.5	10.3	6.8	
<i>NCREIF CL PROP</i>	3.5	7.1	11.1	14.9	10.0	9.2
** PRIVATE EQUITY MANAGERS **						
<i>ALT. ASSETS</i>	- 14.6	- 14.5	- 30.5	- 30.5	- 13.4	

VERMONT MUNICIPAL EMPLOYEES

TOTAL FUNDS - TOTAL RATES OF RETURN

PERIODS ENDING 6/05

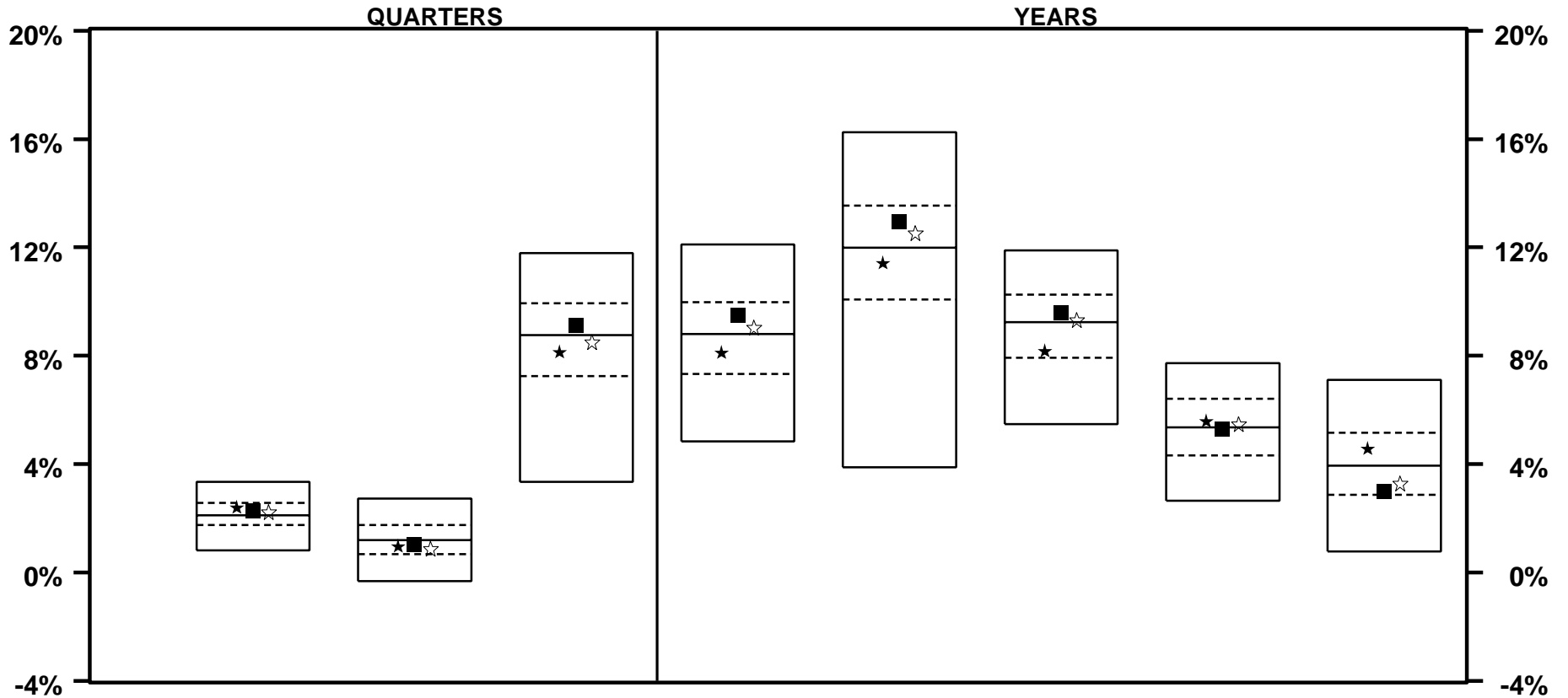

	LAST QTR		LAST 2 QTRS		LAST 3 QTRS		LAST YEAR		LAST 2 YEARS		LAST 3 YEARS		LAST 4 YEARS		LAST 5 YEARS	
★ MUNI COMPOSITE	2.4	34	1.0	63	8.1	62	8.1	61	11.4	59	8.2	71	5.6	44	4.6	37
■ ALLOC INDEX	2.3	40	1.0	60	9.1	41	9.5	35	13.0	32	9.6	39	5.3	50	3.0	70
☆ POLICY INDEX	2.2	42	0.9	67	8.5	55	9.1	43	12.5	40	9.3	47	5.5	47	3.3	66
MEDIAN	2.1		1.2		8.8		8.8		12.0		9.2		5.4		3.9	

VERMONT MUNICIPAL EMPLOYEES

TOTAL FUNDS - TOTAL RATES OF RETURN

PERIODS ENDING 6/05

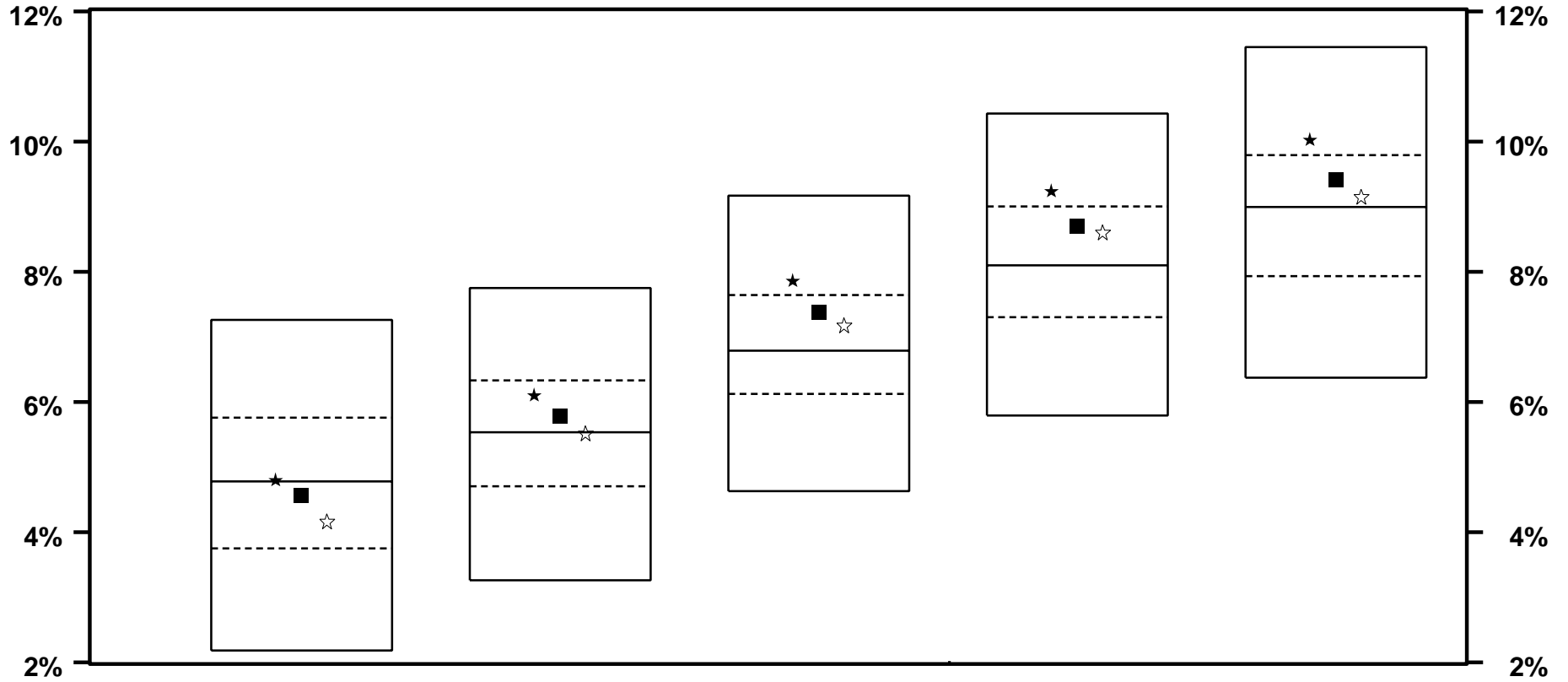

	LAST 6 YEARS		LAST 7 YEARS		LAST 8 YEARS		LAST 9 YEARS		LAST 10 YEARS	
★ MUNI COMPOSITE	4.8	49	6.1	31	7.9	18	9.2	18	10.0	20
■ ALLOC INDEX	4.6	54	5.8	40	7.4	31	8.7	31	9.4	36
☆ POLICY INDEX	4.2	66	5.5	50	7.2	39	8.6	35	9.2	43
MEDIAN	4.8		5.5		6.8		8.1		9.0	

VERMONT MUNICIPAL EMPLOYEES

TOTAL FUNDS - TOTAL RATES OF RETURN

YEARS ENDING

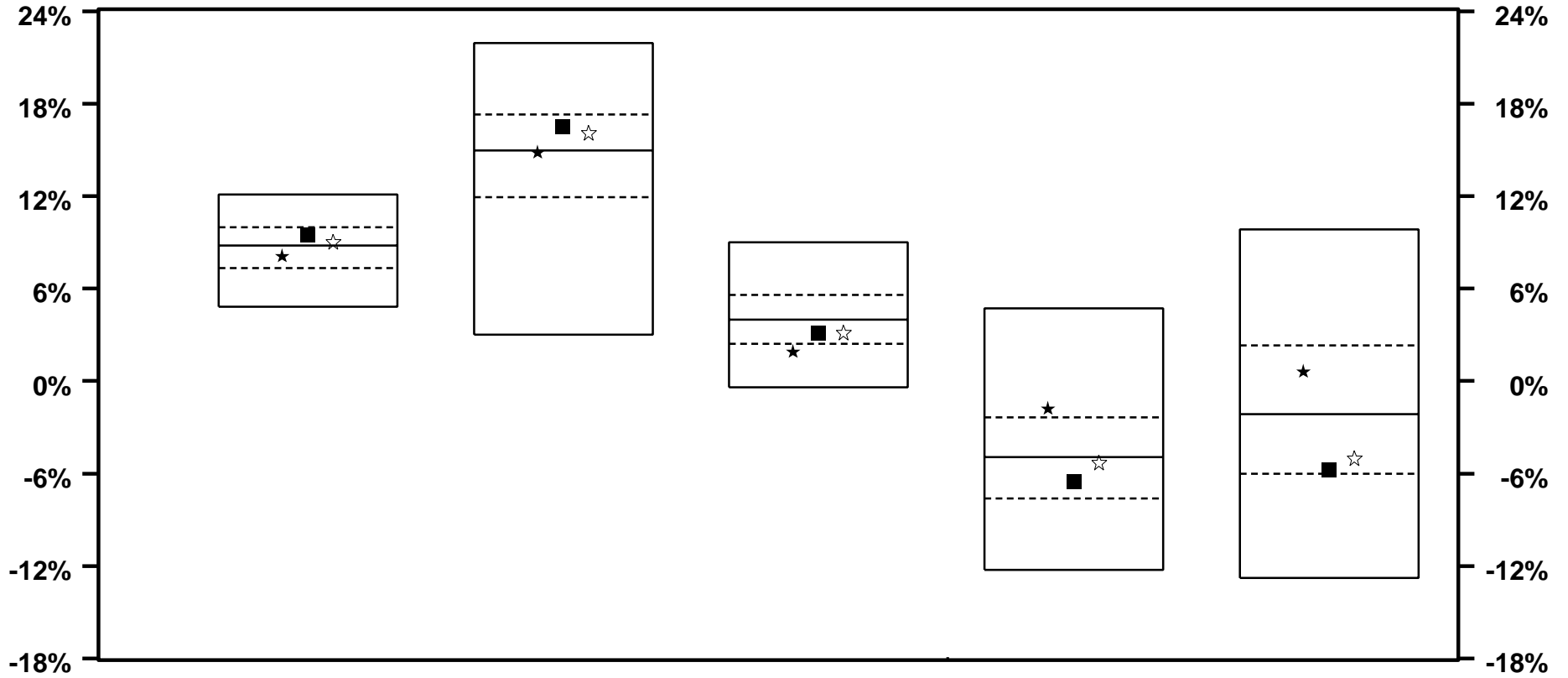

	6 / 05		6 / 04		6 / 03		6 / 02		6 / 01	
★ MUNI COMPOSITE	8.1	61	14.8	51	1.9	80	-1.8	20	0.6	33
■ ALLOC INDEX	9.5	35	16.5	32	3.2	63	-6.5	65	-5.7	73
☆ POLICY INDEX	9.1	43	16.1	36	3.2	63	-5.3	53	-5.0	69
MEDIAN	8.8		15.0		4.0		-4.9		-2.2	

VERMONT MUNICIPAL EMPLOYEES

TOTAL FUNDS - TOTAL RATES OF RETURN

YEARS ENDING

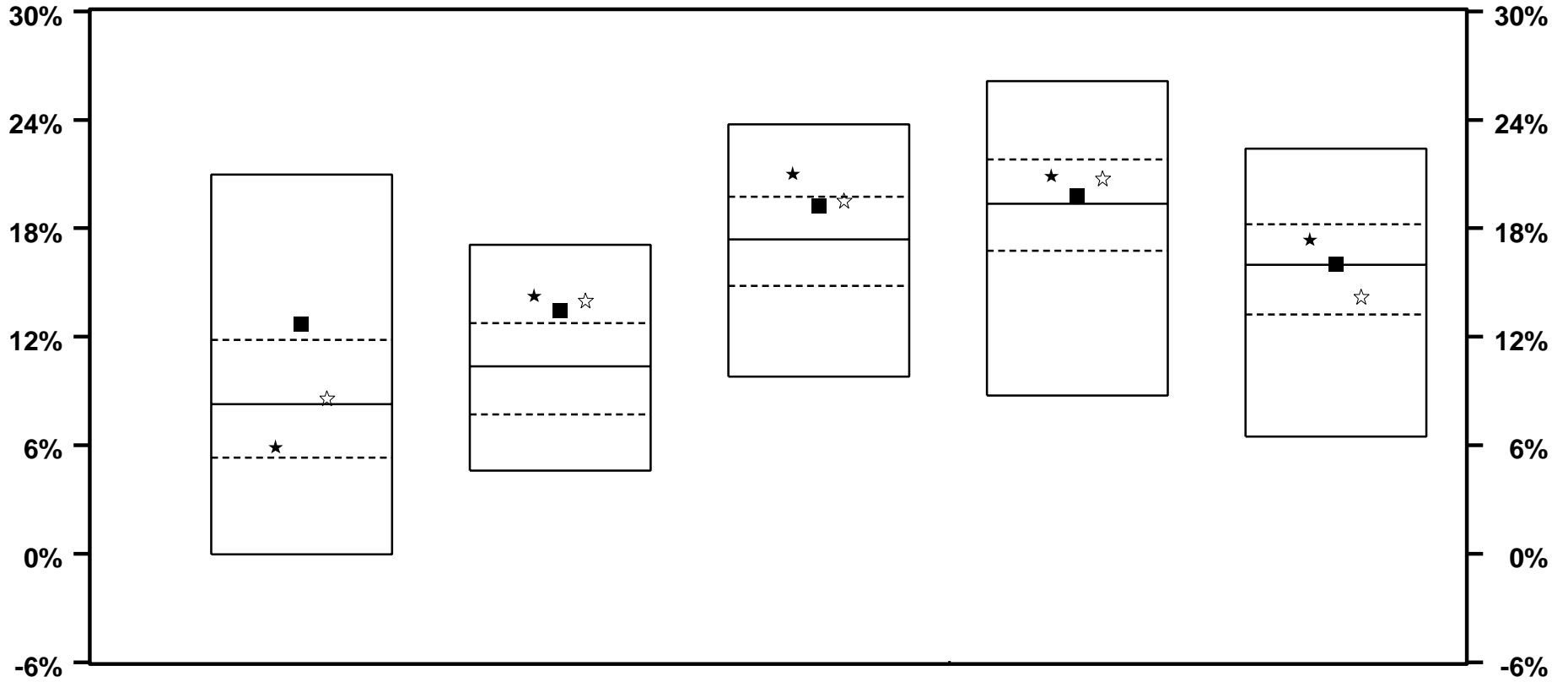

	6 / 00		6 / 99		6 / 98		6 / 97		6 / 96	
★ MUNI COMPOSITE	5.9	69	14.3	15	21.0	15	20.9	34	17.4	33
■ ALLOC INDEX	12.7	21	13.4	19	19.2	29	19.8	44	16.0	49
☆ POLICY INDEX	8.6	48	14.0	16	19.5	26	20.8	35	14.2	68
MEDIAN	8.3		10.4		17.4		19.4		16.0	

VERMONT MUNICIPAL EMPLOYEES

TOTAL FUNDS - TOTAL VS EQUITY ONLY RETURNS

MARKET CYCLE PERFORMANCE COMPARISONS

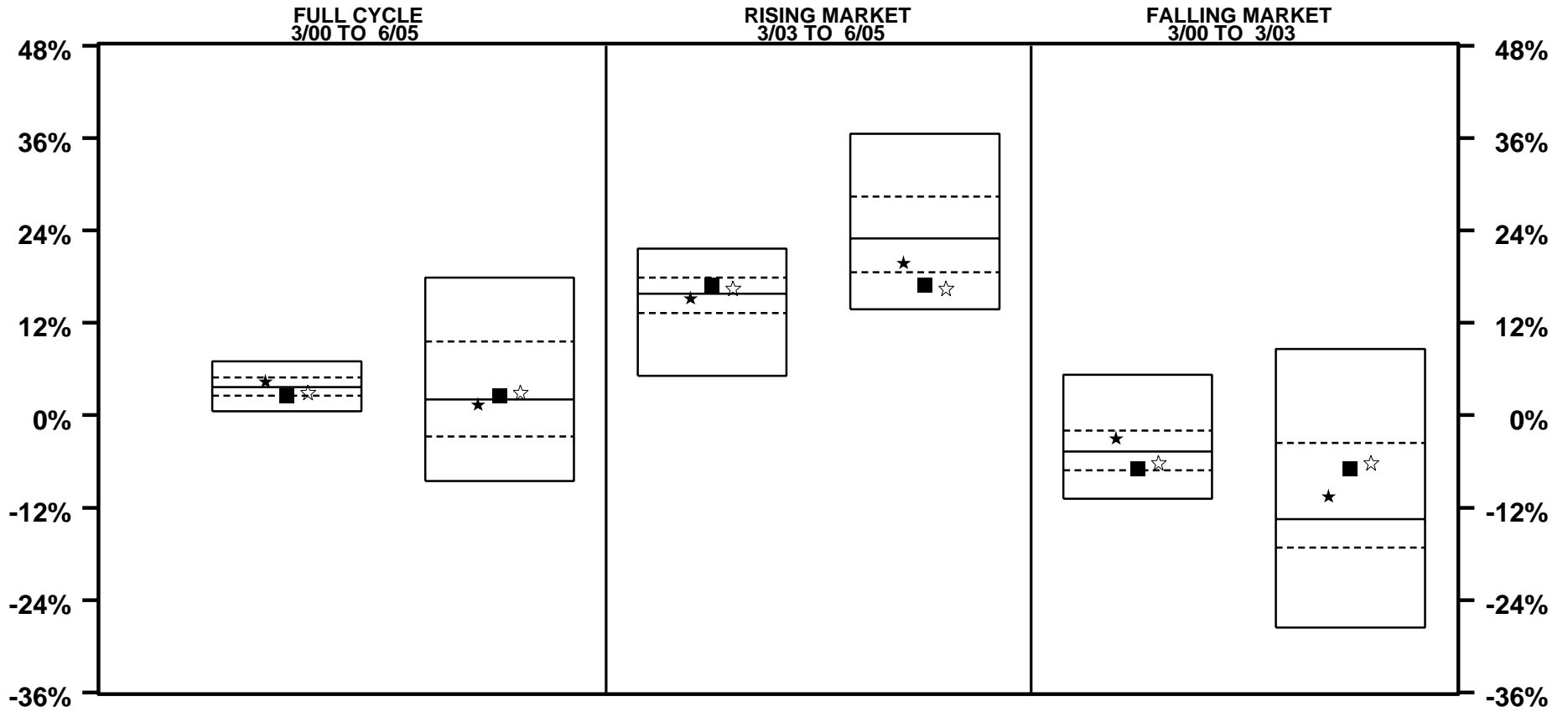

	TOTAL FUND		EQUITY ONLY		TOTAL FUND		EQUITY ONLY		TOTAL FUND		EQUITY ONLY	
★ MUNI COMPOSITE	4.4	33	1.4	52	15.2	59	19.8	68	-3.0	32	-10.5	42
■ ALLOC INDEX	2.6	73	2.6	47	16.9	34	16.9	88	-6.9	73	-6.9	32
☆ POLICY INDEX	3.0	63	3.0	46	16.5	39	16.5	89	-6.1	64	-6.1	30
MEDIAN	3.6		2.0		15.8		23.0		-4.7		-13.5	

VERMONT MUNICIPAL EMPLOYEES

TOTAL FUNDS - TOTAL VS BOND ONLY RETURNS

MARKET CYCLE PERFORMANCE COMPARISONS

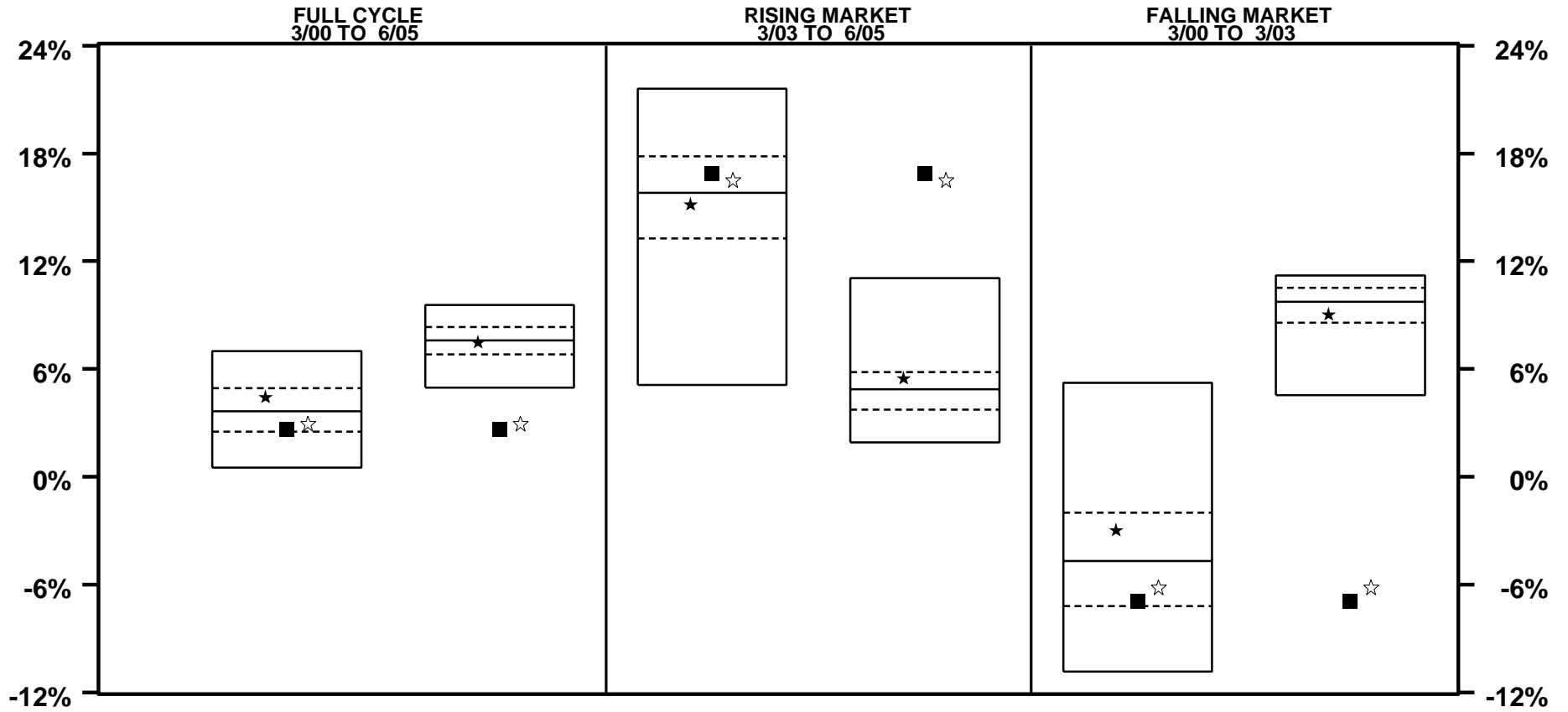

	TOTAL FUND		BONDS ONLY		TOTAL FUND		BONDS ONLY		TOTAL FUND		BONDS ONLY	
★ MUNI COMPOSITE	4.4	33	7.5	53	15.2	59	5.5	35	-3.0	32	9.0	67
■ ALLOC INDEX	2.6	73	2.6	99	16.9	34	16.9	1	-6.9	73	-6.9	99
☆ POLICY INDEX	3.0	63	3.0	99	16.5	39	16.5	1	-6.1	64	-6.1	99
MEDIAN	3.6		7.6		15.8		4.9		-4.7		9.8	

VERMONT MUNICIPAL EMPLOYEES

TOTAL FUNDS - TOTAL RATES OF RETURN

EFFECTS OF EQUITY ALLOCATION ON RATE OF RETURN

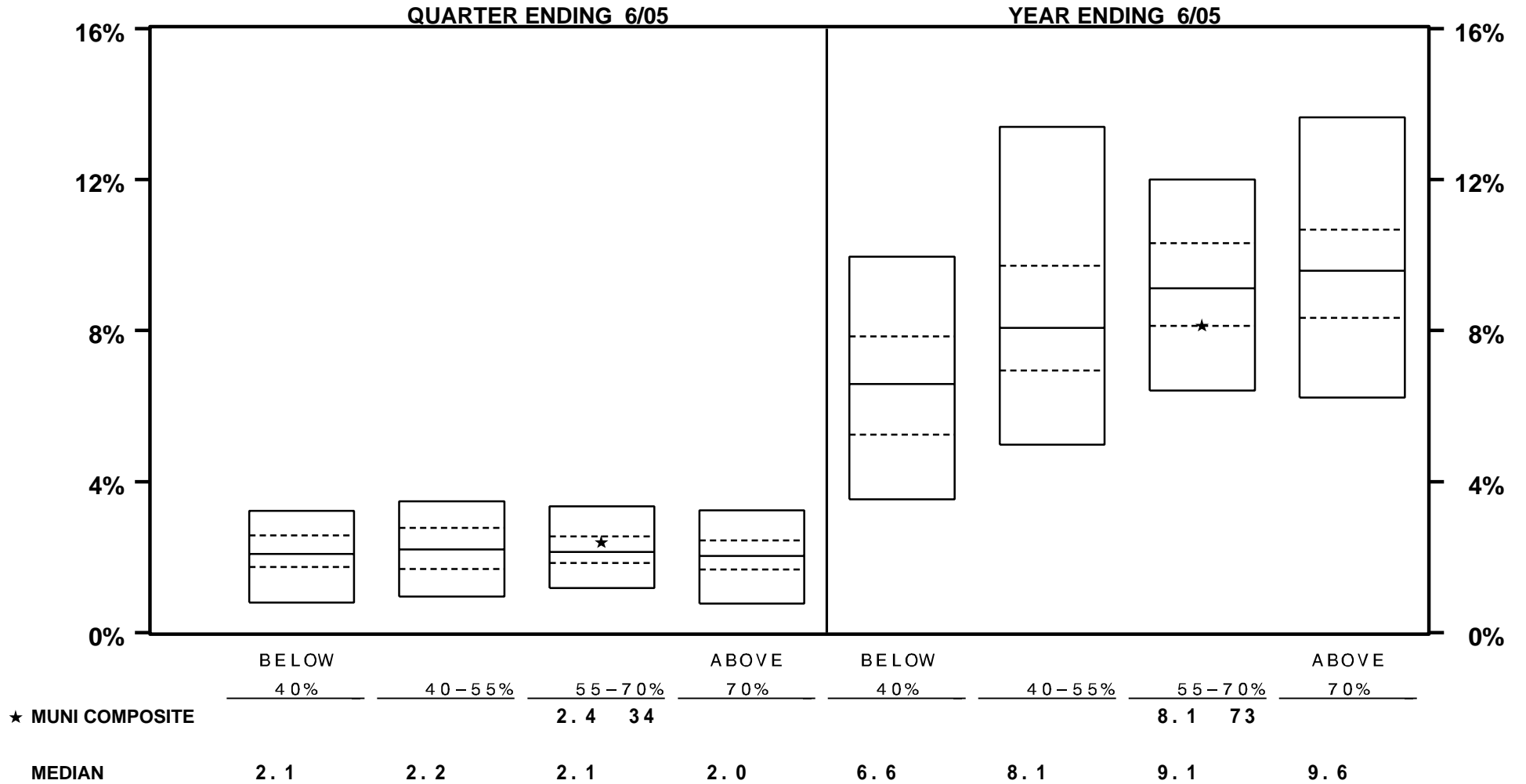

VERMONT MUNICIPAL EMPLOYEES

TOTAL FUNDS - TOTAL RATES OF RETURN

EFFECTS OF EQUITY ALLOCATION ON RATE OF RETURN

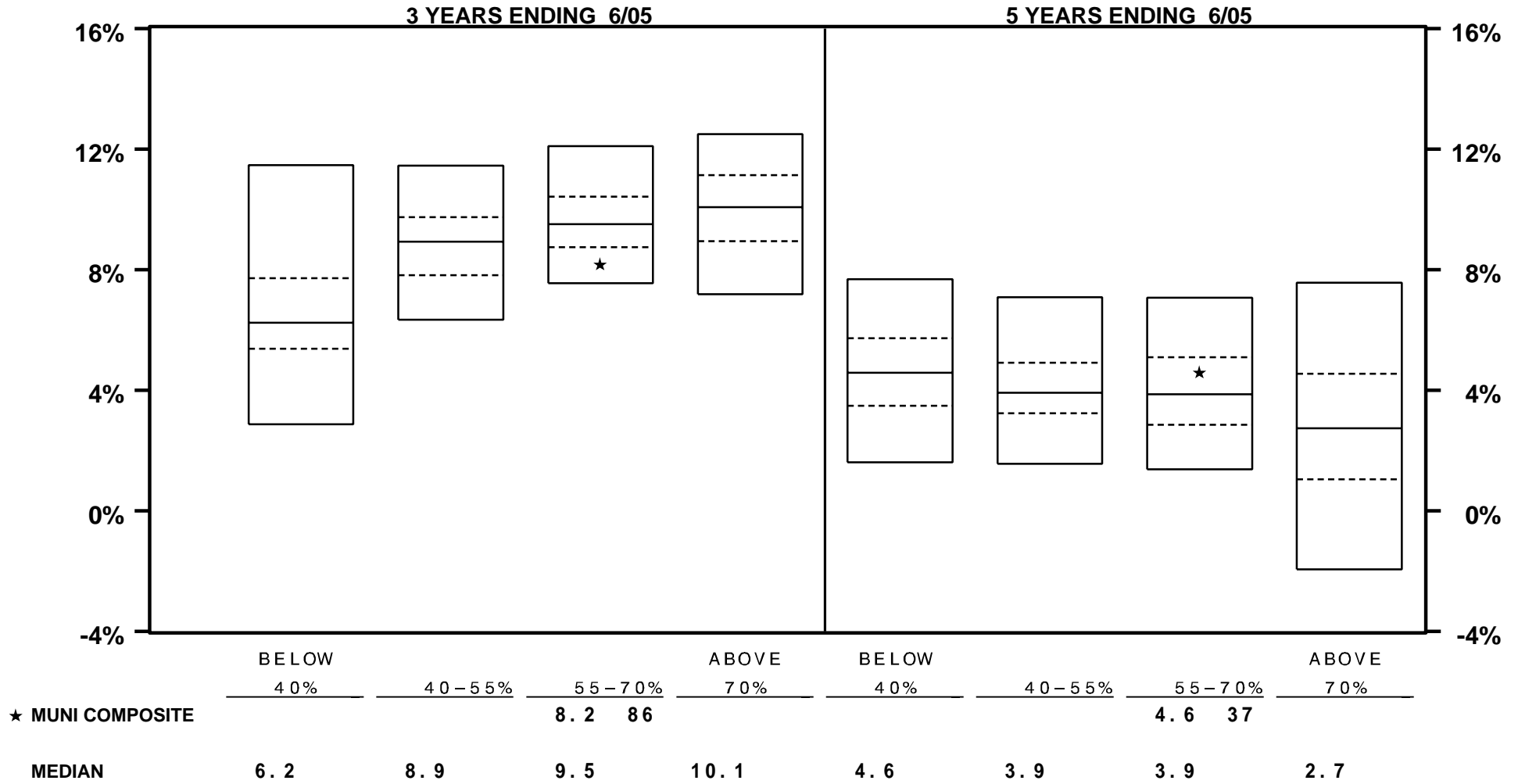

VERMONT MUNICIPAL EMPLOYEES

TOTAL FUNDS - TOTAL FUND INCOME RATES OF RETURN FOR PERIOD ENDING 6/05

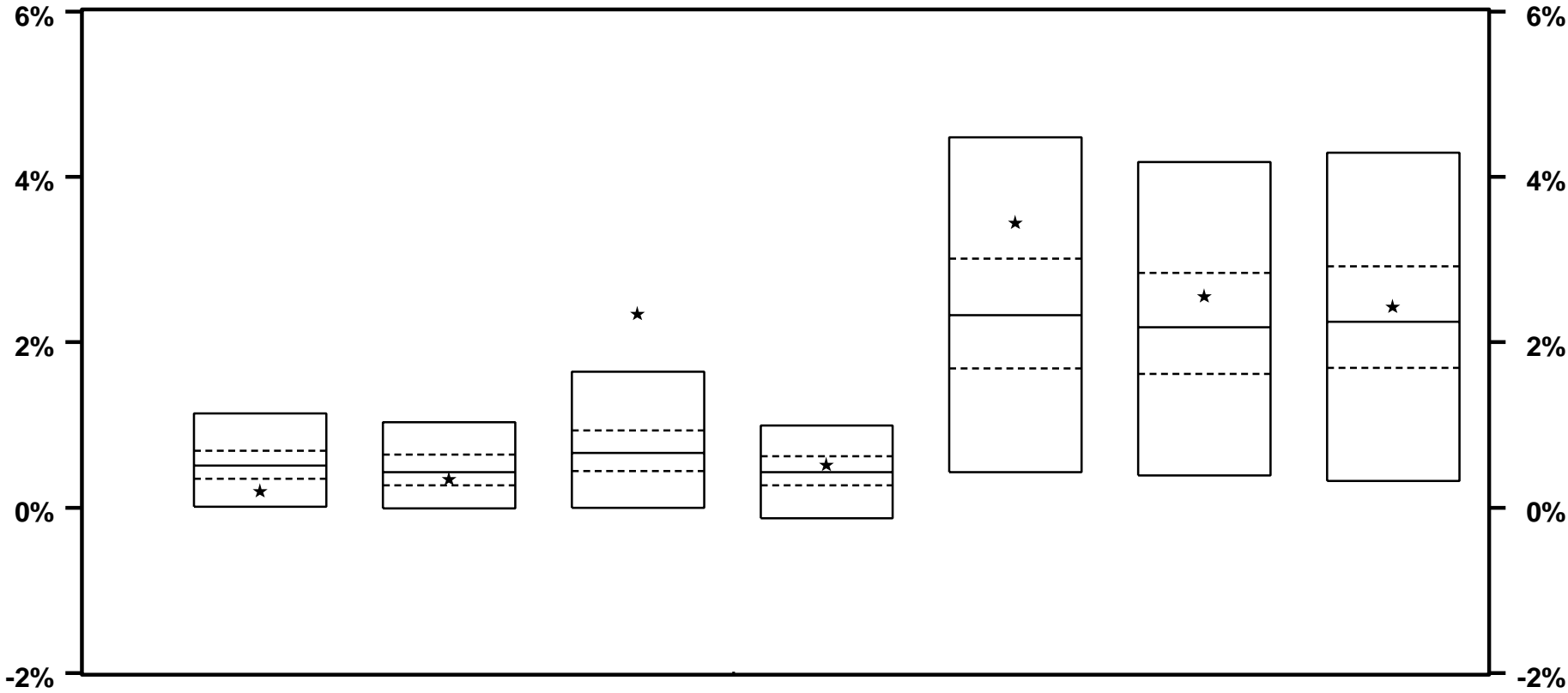

	<u>THIS QUARTER</u>	<u>LAST QUARTER</u>	<u>2 QTRS AGO</u>	<u>3 QTRS AGO</u>	<u>LAST YEAR</u>	<u>LAST 2 YEARS</u>	<u>LAST 3 YEARS</u>
★ MUNI COMPOSITE	0.2 87	0.3 61	2.3 1	0.5 37	3.5 15	2.6 34	2.4 42
MEDIAN	0.5	0.4	0.7	0.4	2.3	2.2	2.3

VERMONT MUNICIPAL EMPLOYEES

TOTAL FUNDS - TOTAL RETURN VS RISK

3 YEARS ENDING 6/05

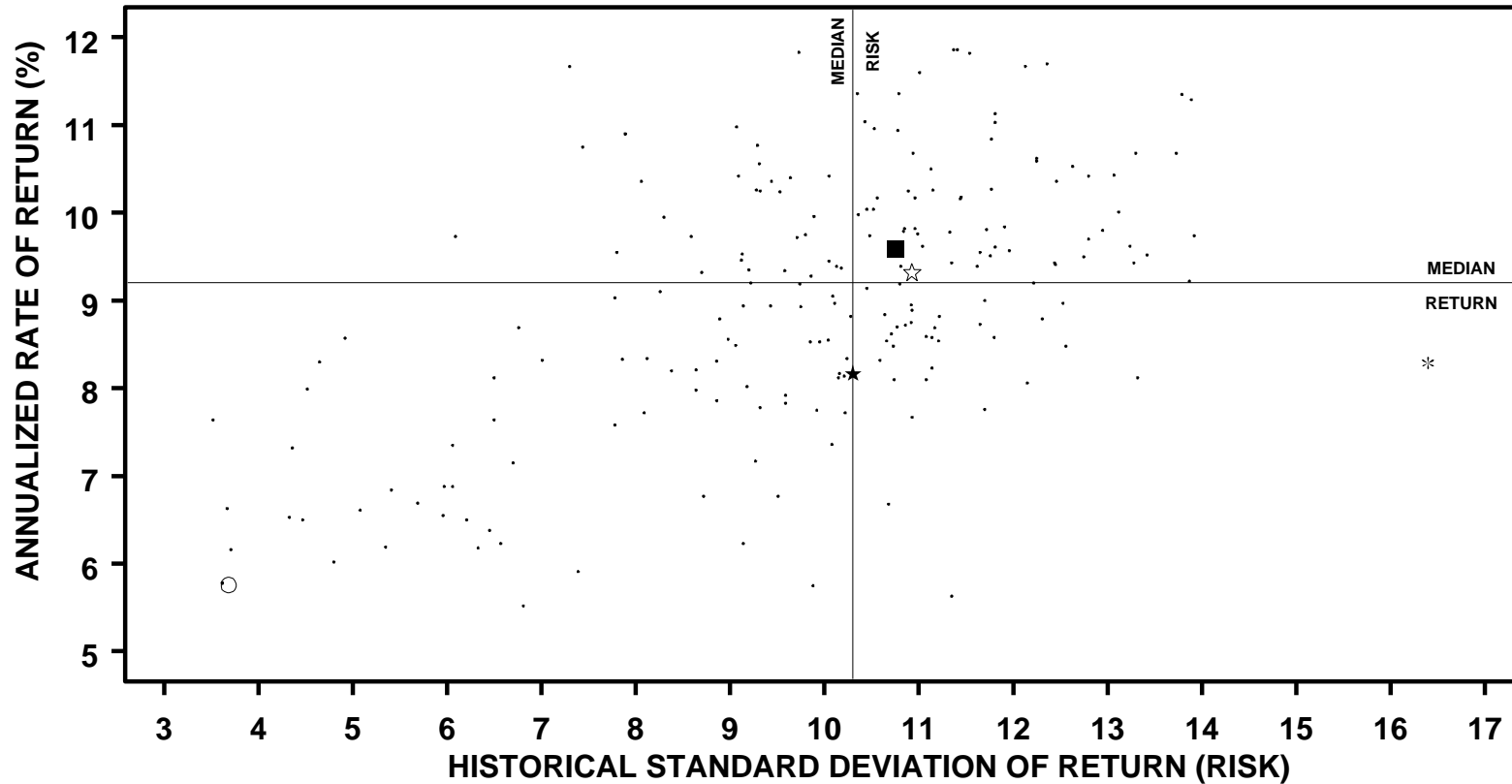

	ANNUALIZED RETURN		STANDARD DEVIATION		SHARPE RATIO	
	VALUE	RANK	VALUE	RANK	VALUE	RANK
★ MUNI COMPOSITE	8.2	71	10.3	50	0.7	79
■ ALLOC INDEX	9.6	39	10.8	41	0.8	54
☆ POLICY INDEX	9.3	47	10.9	37	0.7	63
* S&P 500	8.3	69	16.4	1	0.5	97
○ LB AGGREGATE	5.8	92	3.7	93	1.1	8
MEDIAN	9.2		10.3		0.8	

VERMONT MUNICIPAL EMPLOYEES

TOTAL FUNDS - TOTAL RETURN VS RISK

5 YEARS ENDING 6/05

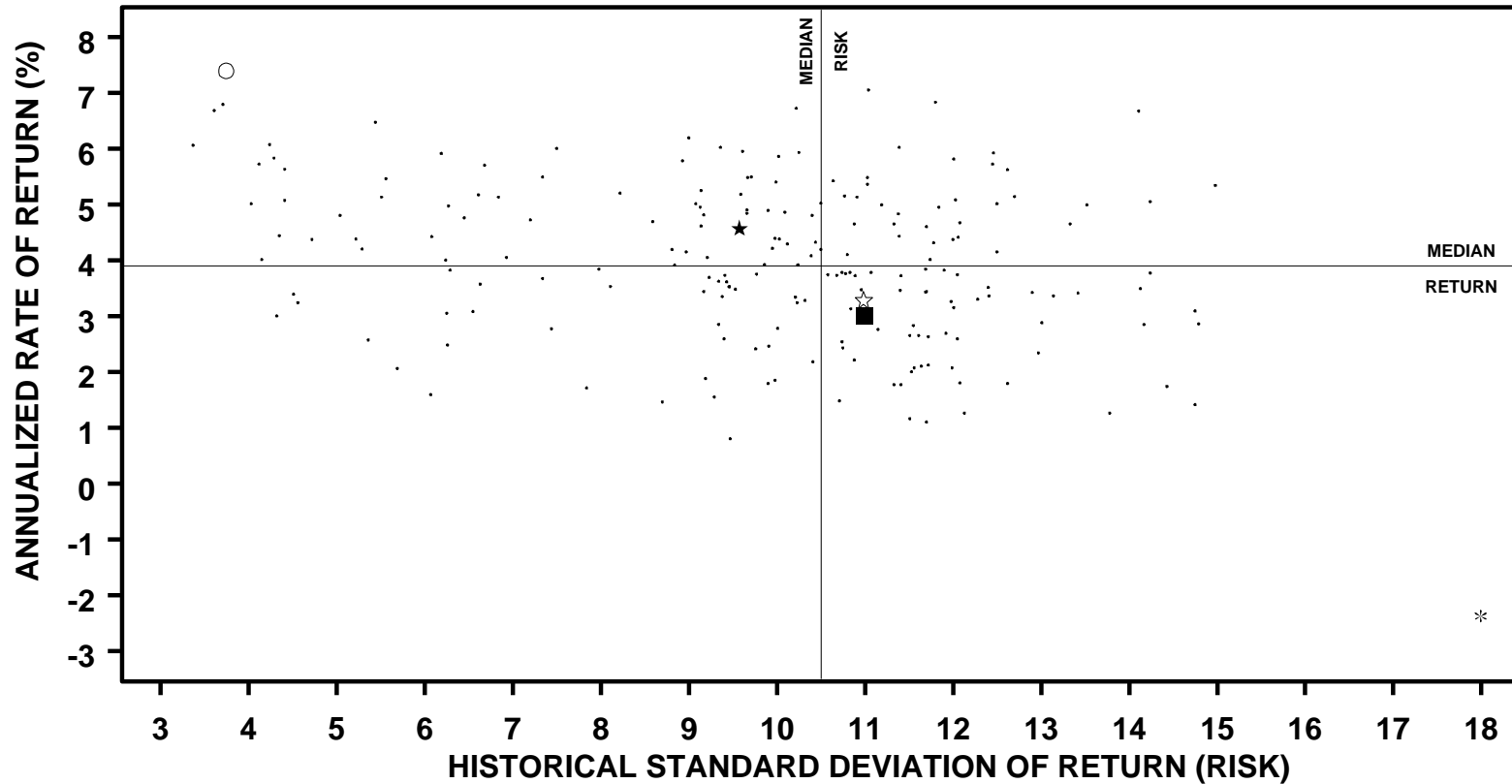

	ANNUALIZED RETURN		STANDARD DEVIATION		SHARPE RATIO	
	VALUE	RANK	VALUE	RANK	VALUE	RANK
★ MUNI COMPOSITE	4.6	37	9.6	65	0.2	36
■ ALLOC INDEX	3.0	70	11.0	42	0.1	70
☆ POLICY INDEX	3.3	66	11.0	42	0.1	65
* S&P 500	-2.4	100	18.0	1	-0.2	
○ LB AGGREGATE	7.4	3	3.8	92	1.2	1
MEDIAN	3.9		10.5		0.2	

VERMONT MUNICIPAL EMPLOYEES

EQUITY FUNDS - TOTAL RATES OF RETURN

PERIODS ENDING 6/05

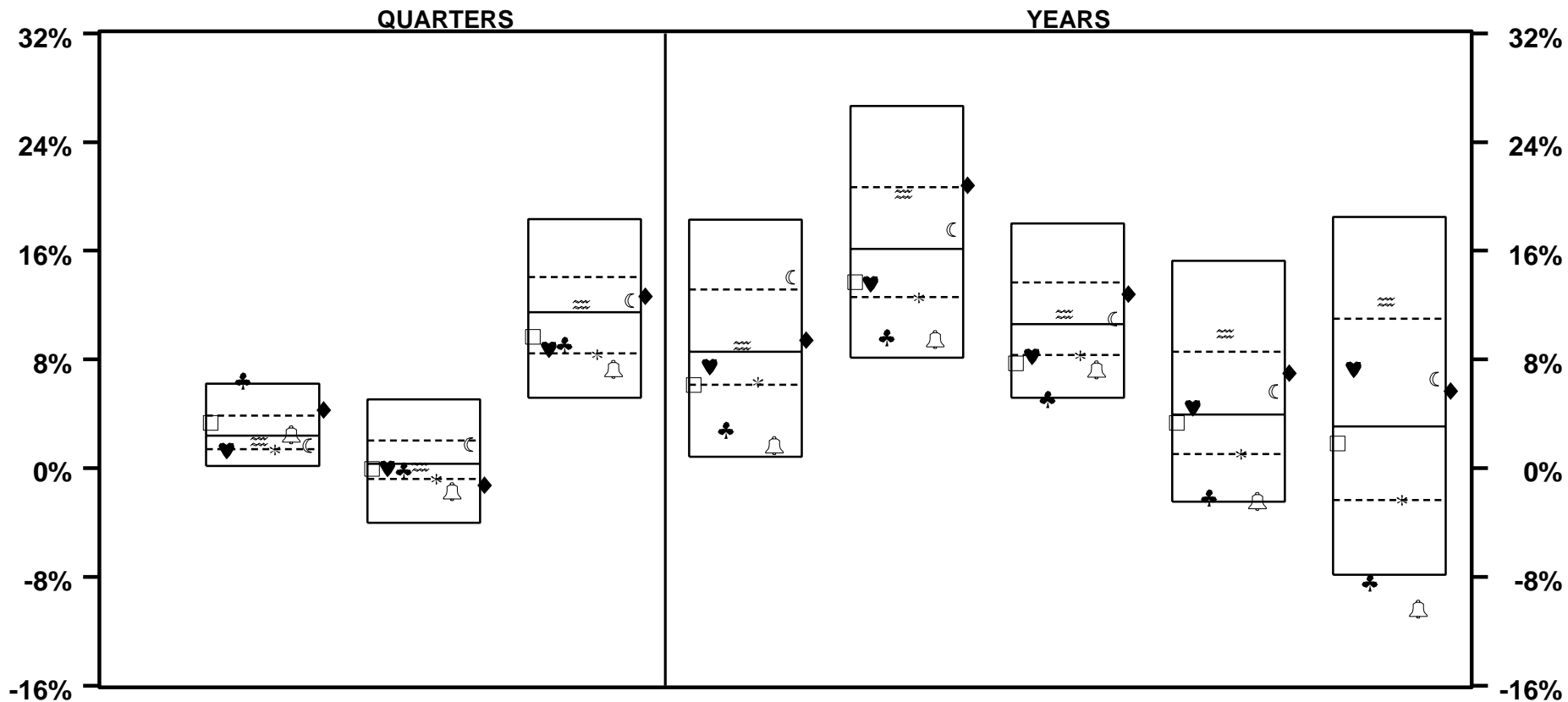

	LAST QTR		LAST 2 QTRS		LAST 3 QTRS		LAST YEAR		LAST 2 YEARS		LAST 3 YEARS		LAST 4 YEARS		LAST 5 YEARS	
□ EQTY COMPOSITE	3.3	32	0.0	57	9.7	64	6.1	74	13.7	66	7.7	83	3.4	53	1.8	53
♥ DELAWARE	1.3	79	0.0	56	8.7	72	7.5	57	13.6	67	8.2	78	4.5	47	7.3	35
♣ ALLIANCE	6.4	4	-0.2	59	9.1	69	2.8	90	9.7	91	5.1	95	-2.1	94	-8.4	95
≍ LAZARD	2.0	59	0.1	54	12.1	44	9.0	48	20.2	28	11.4	43	9.9	19	12.3	20
* S&P 500	1.4	76	-0.8	75	8.3	79	6.3	72	12.5	79	8.3	77	1.0	77	-2.4	77
🔔 R 1000(R) GR	2.5	49	-1.7	84	7.3	87	1.7	93	9.5	91	7.3	86	-2.4	94	-10.4	97
☾ R 1000(R) VALUE	1.7	66	1.8	29	12.3	42	14.1	17	17.5	40	11.0	46	5.6	39	6.6	38
◆ R 2000(R)	4.3	18	-1.3	81	12.7	38	9.4	46	20.8	24	12.8	31	7.0	31	5.7	42
MEDIAN	2.4		0.3		11.5		8.6		16.1		10.6		3.9		3.1	

VERMONT MUNICIPAL EMPLOYEES

EQUITY FUNDS - TOTAL RATES OF RETURN

PERIODS ENDING 6/05

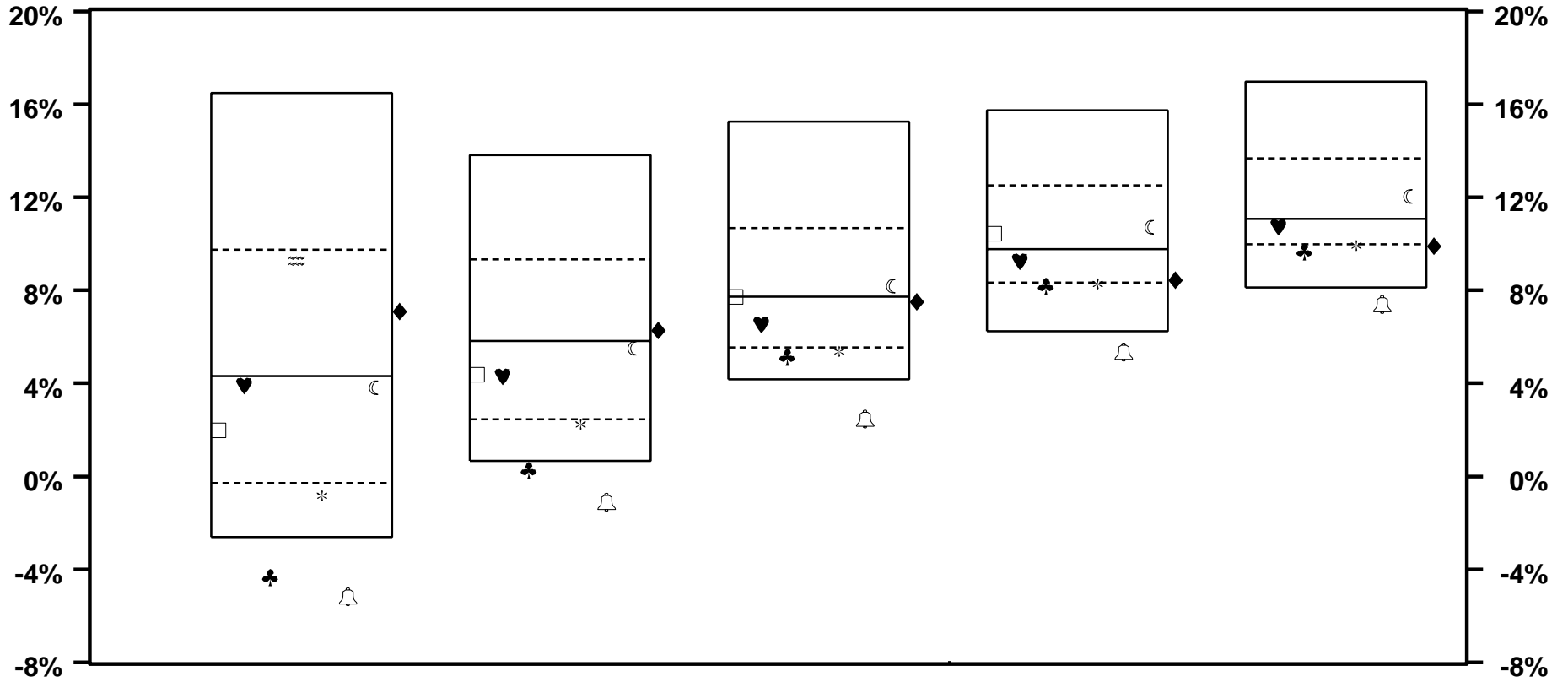

	LAST 6 YEARS		LAST 7 YEARS		LAST 8 YEARS		LAST 9 YEARS		LAST 10 YEARS	
□ EQTY COMPOSITE	2.0	64	4.4	61	7.7	50	10.4	42		
♥ DELAWARE	3.9	52	4.3	62	6.5	64	9.3	59	10.7	57
♣ ALLIANCE	-4.3	97	0.3	96	5.1	89	8.2	82	9.7	85
≍ LAZARD	9.3	26								
* S&P 500	-0.8	85	2.2	84	5.4	84	8.3	79	9.9	79
🔔 R 1000(R) GR	-5.2	98	-1.1	98	2.5	98	5.3	97	7.4	97
☾ R 1000(R) VALUE	3.8	52	5.5	53	8.2	43	10.7	39	12.0	40
◆ R 2000(R)	7.1	34	6.3	46	7.5	53	8.5	69	9.9	81
MEDIAN	4.3		5.8		7.7		9.8		11.1	

VERMONT MUNICIPAL EMPLOYEES

EQUITY FUNDS - TOTAL RATES OF RETURN

YEARS ENDING

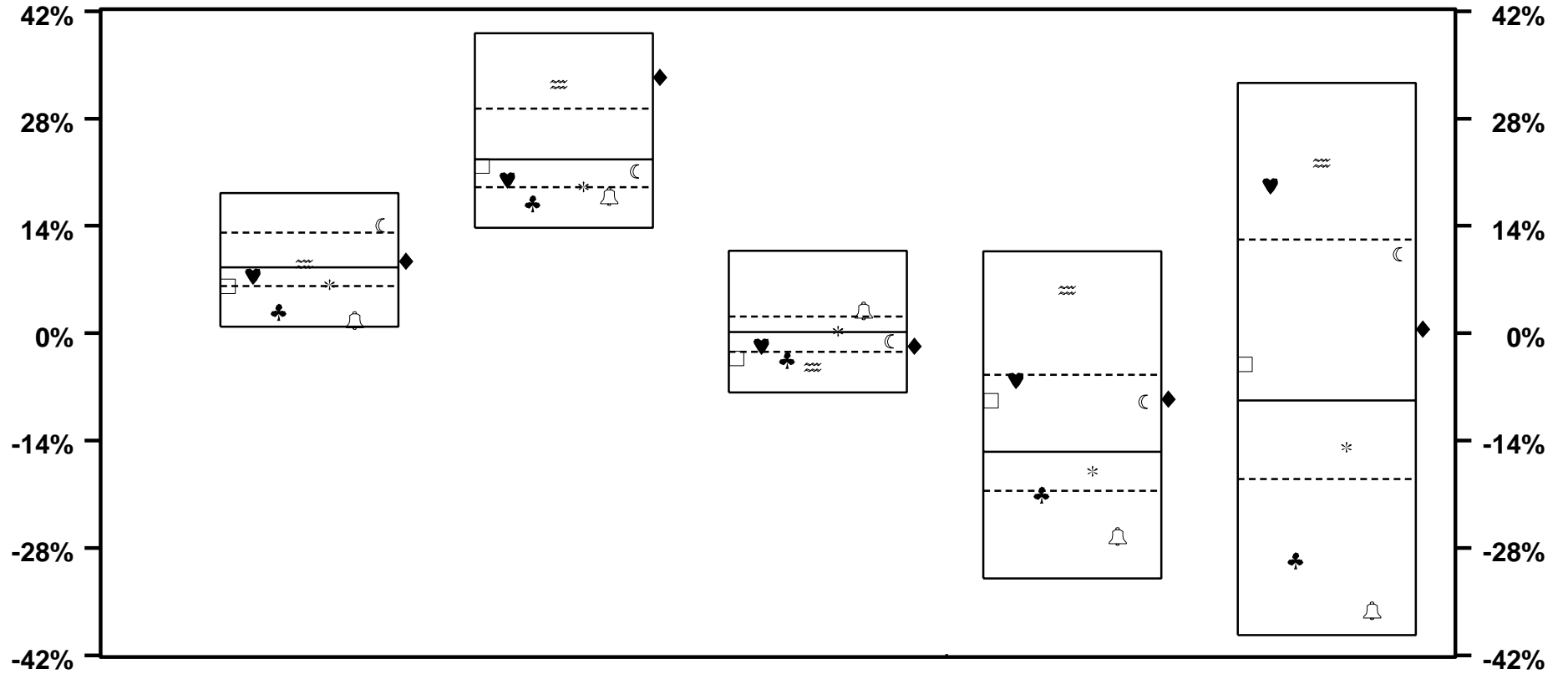

	6 / 05		6 / 04		6 / 03		6 / 02		6 / 01	
□ EQTY COMPOSITE	6.1	74	21.8	53	-3.3	80	-8.7	31	-4.1	45
♥ DELAWARE	7.5	57	20.0	63	-1.7	68	-6.1	26	19.3	18
♣ ALLIANCE	2.8	90	16.9	86	-3.5	81	-21.0	76	-29.6	87
≡ LAZARD	9.0	48	32.5	15	-4.4	85	5.6	9	22.2	15
* S&P 500	6.3	72	19.1	72	0.3	47	-18.0	63	-14.8	65
🔔 R 1000(R) GR	1.7	93	17.9	83	2.9	21	-26.5	88	-36.2	93
☾ R 1000(R) VALUE	14.1	17	21.1	56	-1.0	61	-9.0	32	10.3	28
◆ R 2000(R)	9.4	46	33.4	14	-1.6	67	-8.6	31	0.6	40
MEDIAN	8.6		22.7		0.2		-15.5		-8.8	

VERMONT MUNICIPAL EMPLOYEES

EQUITY FUNDS - TOTAL RATES OF RETURN

YEARS ENDING

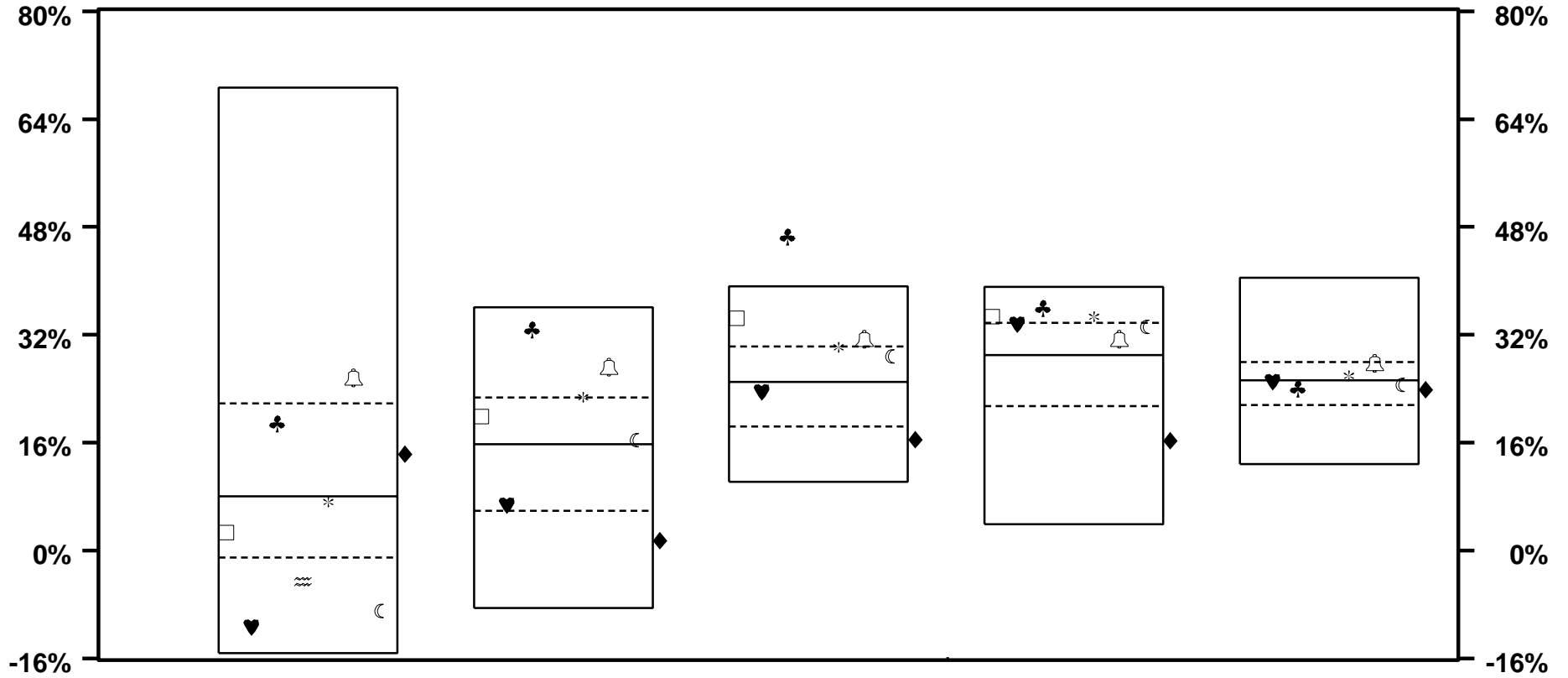

	6 / 00		6 / 99		6 / 98		6 / 97		6 / 96	
□ EQTY COMPOSITE	2.7	70	19.9	35	34.5	11	34.7	18		
♥ DELAWARE	-11.3	91	6.7	73	23.5	55	33.6	25	25.1	52
♣ ALLIANCE	18.9	30	32.8	7	46.6	1	36.0	11	24.0	59
≡ LAZARD	-4.5	80								
* S&P 500	7.3	57	22.8	24	30.2	27	34.7	18	25.9	42
🔔 R 1000(R) GR	25.6	20	27.3	11	31.4	19	31.3	38	27.8	25
☾ R 1000(R) VALUE	-8.9	87	16.4	48	28.8	37	33.2	28	24.6	55
◆ R 2000(R)	14.3	37	1.5	82	16.5	82	16.3	83	23.9	60
MEDIAN	8.1		15.8		25.0		29.0		25.3	

VERMONT MUNICIPAL EMPLOYEES

EQUITY FUNDS - TOTAL VS EQUITY ONLY RETURNS

MARKET CYCLE PERFORMANCE COMPARISONS

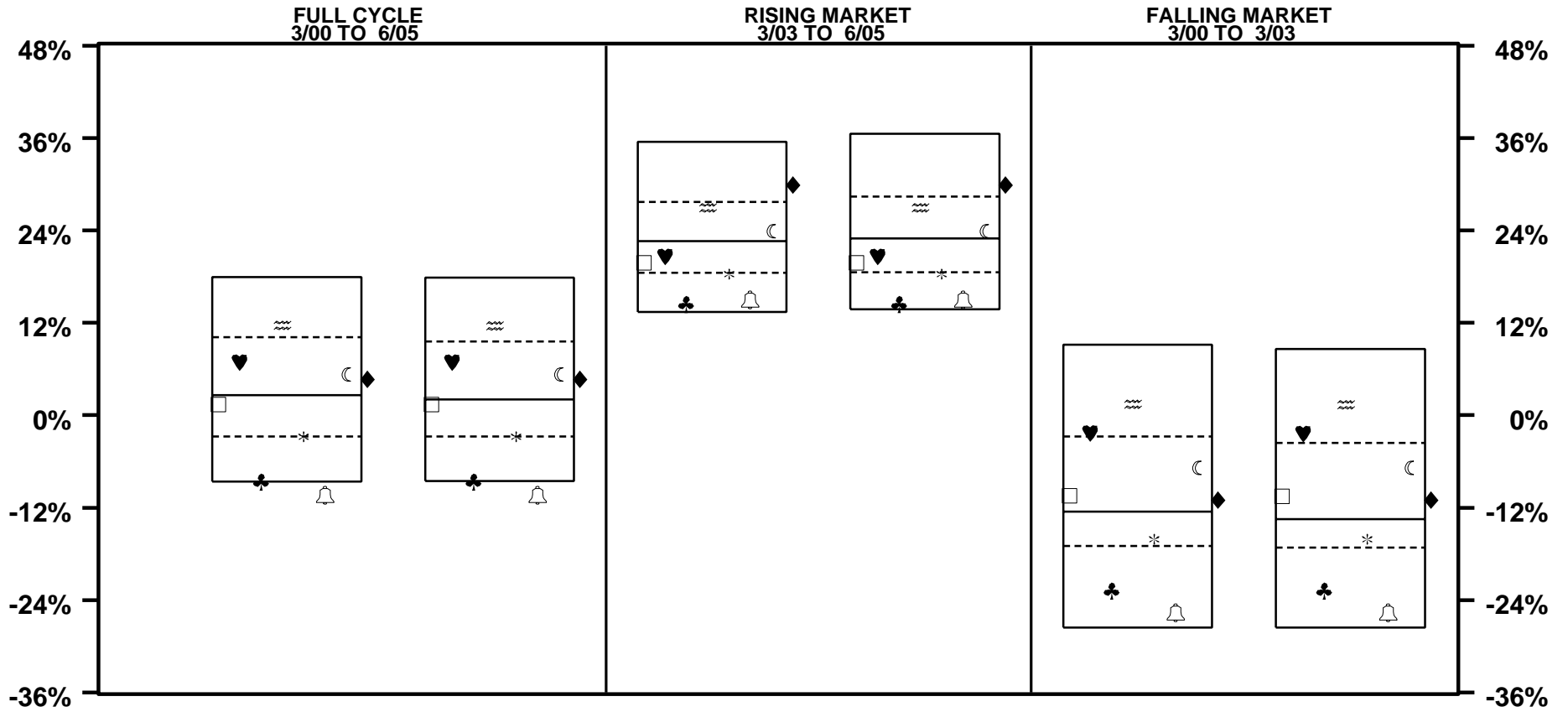

	TOTAL FUND		EQUITY ONLY		TOTAL FUND		EQUITY ONLY		TOTAL FUND		EQUITY ONLY	
□ EQTY COMPOSITE	1.4	53	1.4	52	19.8	66	19.8	68	-10.5	44	-10.5	42
♥ DELAWARE	6.9	35	6.9	33	20.6	61	20.7	62	-2.3	23	-2.3	22
♣ ALLIANCE	-8.6	95	-8.6	95	14.5	92	14.5	92	-22.8	87	-22.8	87
≡ LAZARD	11.7	21	11.6	20	27.0	29	27.0	30	1.4	16	1.4	15
* S&P 500	-2.8	76	-2.8	76	18.4	80	18.4	80	-16.1	68	-16.1	68
🔔 R 1000(R) GR	-10.4	97	-10.4	97	15.0	91	15.0	91	-25.6	92	-25.6	92
☾ R 1000(R) VALUE	5.3	41	5.3	39	23.9	42	23.9	44	-6.9	34	-6.9	32
◆ R 2000(R)	4.7	42	4.7	41	29.9	15	29.9	17	-11.0	46	-11.0	43
MEDIAN	2.6		2.0		22.6		23.0		-12.5		-13.5	

VERMONT MUNICIPAL EMPLOYEES

EQUITY FUNDS - TOTAL FUND INCOME RATES OF RETURN FOR PERIOD ENDING 6/05

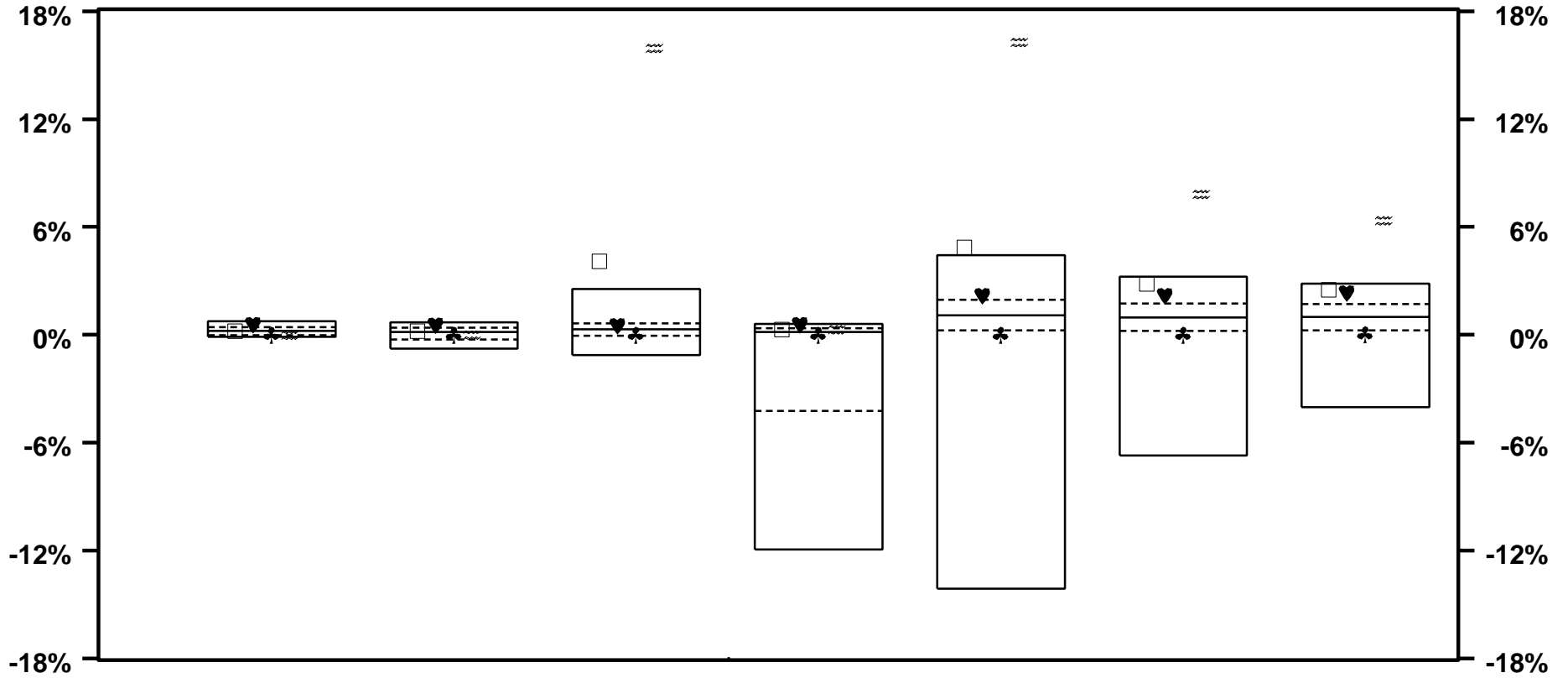

	THIS QUARTER		LAST QUARTER		2 QTRS AGO		3 QTRS AGO		LAST YEAR		LAST 2 YEARS		LAST 3 YEARS	
□ EQTY COMPOSITE	0.2	47	0.2	44	4.1	2	0.3	33	4.9	3	2.8	6	2.5	7
♥ DELAWARE	0.6	12	0.5	10	0.5	34	0.6	7	2.2	17	2.2	14	2.3	10
♣ ALLIANCE	0.0	66	0.0	65	0.0	74	0.0	63	0.0	79	0.0	79	0.0	82
≡ LAZARD	0.0	66	0.0	65	15.9	1	0.3	35	16.3	1	7.8	1	6.4	1
MEDIAN	0.2		0.2		0.3		0.2		1.1		1.0		1.0	

VERMONT MUNICIPAL EMPLOYEES

EQUITY FUNDS - TOTAL RETURN VS RISK

3 YEARS ENDING 6/05

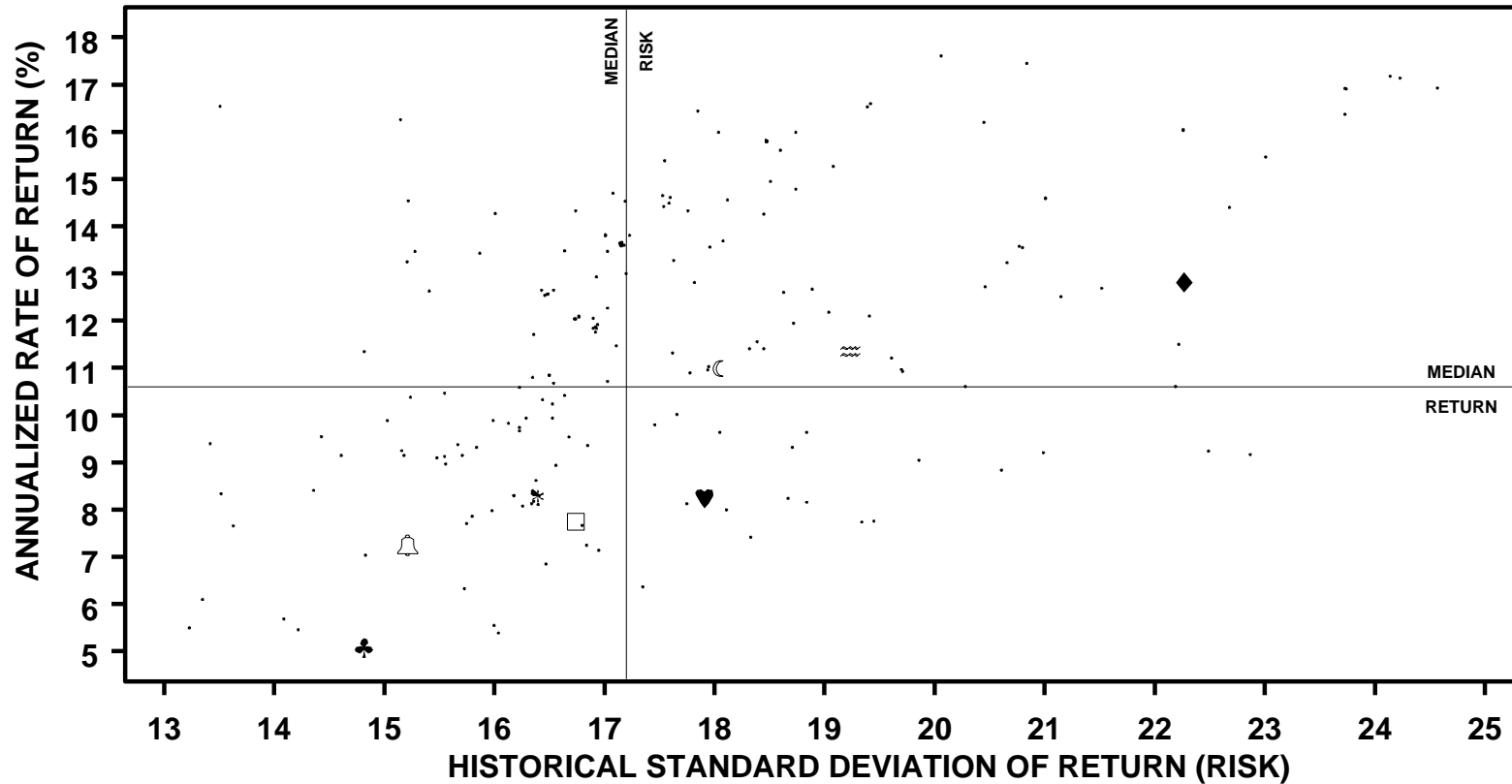

	ANNUALIZED RETURN		STANDARD DEVIATION		SHARPE RATIO	
	VALUE	RANK	VALUE	RANK	VALUE	RANK
□ EQTY COMPOSITE	7.7	83	16.7	57	0.4	83
♥ DELAWARE	8.2	78	17.9	41	0.5	81
♣ ALLIANCE	5.1	95	14.8	86	0.3	95
≍ LAZARD	11.4	43	19.2	29	0.6	47
* S&P 500	8.3	77	16.4	65	0.5	71
🔔 R 1000(R) GR	7.3	86	15.2	84	0.4	84
☾ R 1000(R) VALUE	11.0	46	18.0	40	0.6	45
◆ R 2000(R)	12.8	31	22.3	11	0.6	45
MEDIAN	10.6		17.2		0.6	

VERMONT MUNICIPAL EMPLOYEES

EQUITY FUNDS - TOTAL RETURN VS RISK

5 YEARS ENDING 6/05

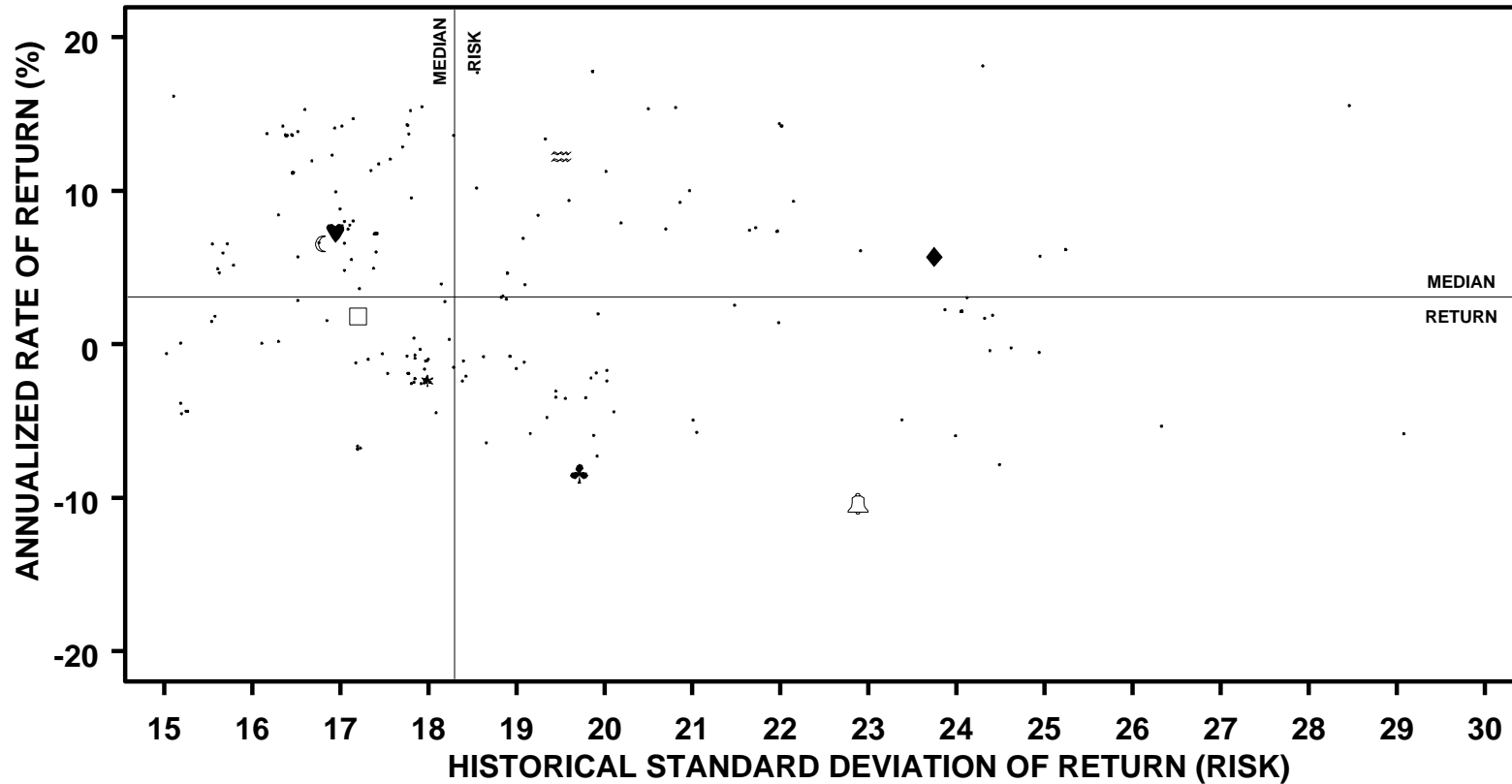

	ANNUALIZED RETURN		STANDARD DEVIATION		SHARPE RATIO	
	VALUE	RANK	VALUE	RANK	VALUE	RANK
□ EQTY COMPOSITE	1.8	53	17.2	74	0.0	55
♥ DELAWARE	7.3	35	17.0	76	0.4	34
♣ ALLIANCE	-8.4	95	19.7	37	-0.5	
≍ LAZARD	12.3	20	19.5	39	0.6	22
* S&P 500	-2.4	77	18.0	54	-0.2	
🔔 R 1000(R) GR	-10.4	97	22.9	21	-0.5	
☾ R 1000(R) VALUE	6.6	38	16.8	78	0.3	37
◆ R 2000(R)	5.7	42	23.7	18	0.2	42
MEDIAN	3.1		18.3		0.1	

VERMONT MUNICIPAL EMPLOYEES

EQUITY ONLY - RATES OF RETURN

PERIODS ENDING 6/05

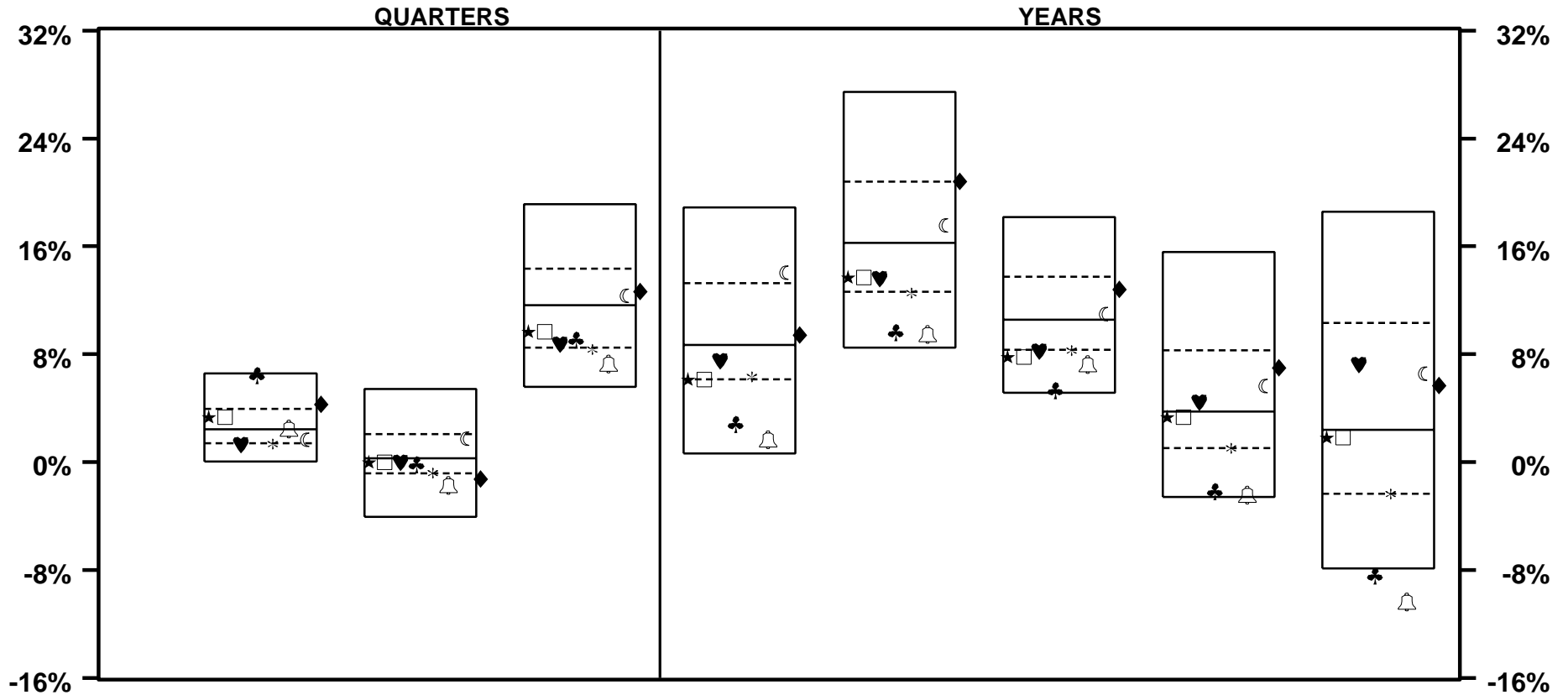

	LAST QTR		LAST 2 QTRS		LAST 3 QTRS		LAST YEAR		LAST 2 YEARS		LAST 3 YEARS		LAST 4 YEARS		LAST 5 YEARS	
★ MUNI COMPOSITE	3.3	33	0.0	56	9.7	65	6.2	74	13.7	67	7.8	83	3.3	52	1.8	52
□ EQTY COMPOSITE	3.3	33	0.0	56	9.7	65	6.2	74	13.7	67	7.8	83	3.3	52	1.8	52
♥ DELAWARE	1.3	80	0.0	55	8.8	72	7.5	57	13.6	68	8.2	79	4.5	45	7.3	33
♣ ALLIANCE	6.4	5	-0.2	58	9.1	70	2.8	89	9.7	92	5.3	94	-2.2	93	-8.4	96
* S&P 500	1.4	77	-0.8	74	8.3	80	6.3	72	12.5	79	8.3	78	1.0	76	-2.4	77
🔔 R 1000(R) GR	2.5	49	-1.7	83	7.3	87	1.7	93	9.5	92	7.3	87	-2.4	94	-10.4	97
☾ R 1000(R) VALUE	1.7	66	1.8	29	12.3	43	14.1	18	17.5	41	11.0	46	5.6	38	6.6	36
◆ R 2000(R)	4.3	19	-1.3	80	12.7	39	9.4	47	20.8	24	12.8	32	7.0	30	5.7	40
MEDIAN	2.4		0.3		11.6		8.7		16.3		10.6		3.8		2.4	

VERMONT MUNICIPAL EMPLOYEES

EQUITY ONLY - RATES OF RETURN

PERIODS ENDING 6/05

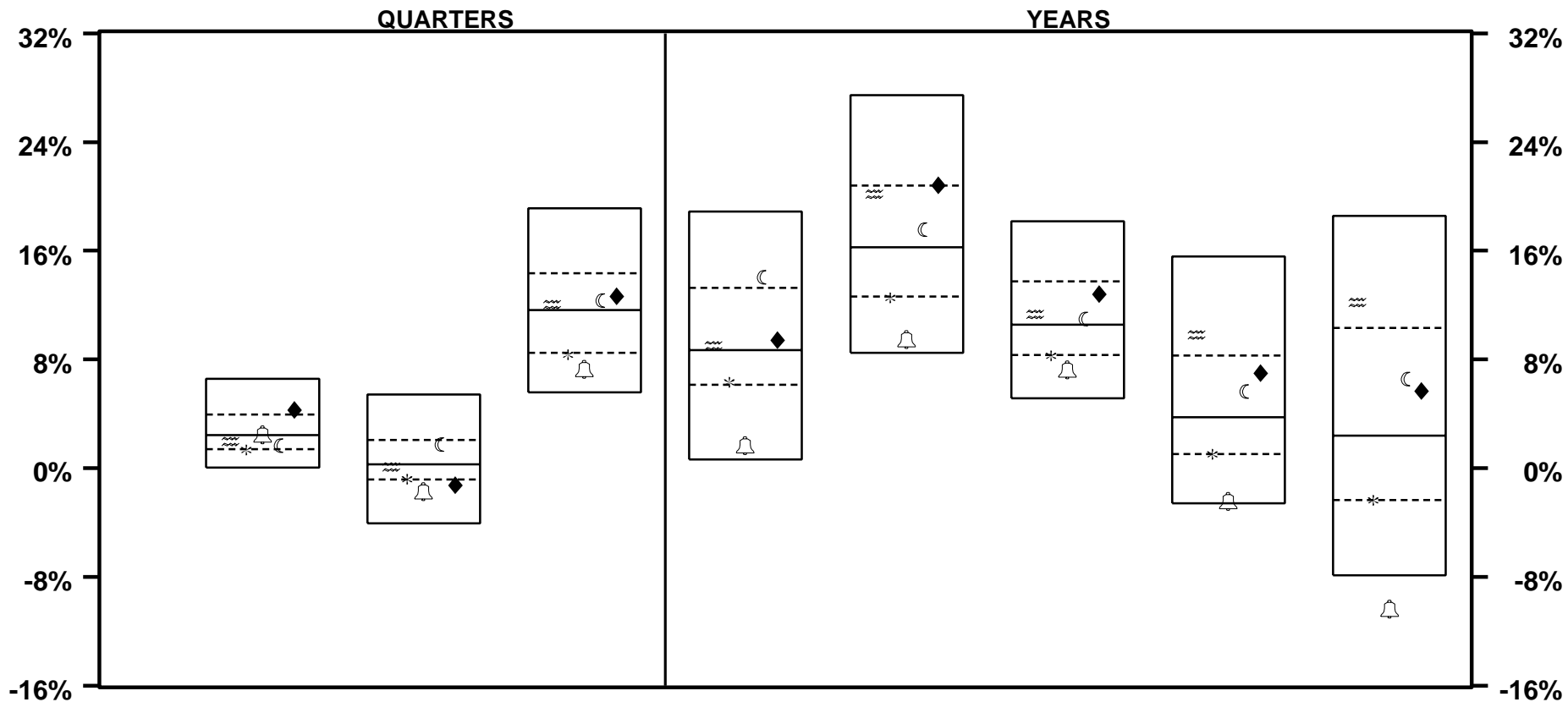

	LAST QTR		LAST 2 QTRS		LAST 3 QTRS		LAST YEAR		LAST 2 YEARS		LAST 3 YEARS		LAST 4 YEARS		LAST 5 YEARS	
≈ LAZARD	2.0	60	0.1	53	12.1	45	9.0	49	20.2	28	11.4	44	9.8	19	12.2	20
* S&P 500	1.4	77	-0.8	74	8.3	80	6.3	72	12.5	79	8.3	78	1.0	76	-2.4	77
🔔 R 1000(R) GR	2.5	49	-1.7	83	7.3	87	1.7	93	9.5	92	7.3	87	-2.4	94	-10.4	97
☾ R 1000(R) VALUE	1.7	66	1.8	29	12.3	43	14.1	18	17.5	41	11.0	46	5.6	38	6.6	36
◆ R 2000(R)	4.3	19	-1.3	80	12.7	39	9.4	47	20.8	24	12.8	32	7.0	30	5.7	40
MEDIAN	2.4		0.3		11.6		8.7		16.3		10.6		3.8		2.4	

VERMONT MUNICIPAL EMPLOYEES

EQUITY ONLY - RATES OF RETURN

PERIODS ENDING 6/05

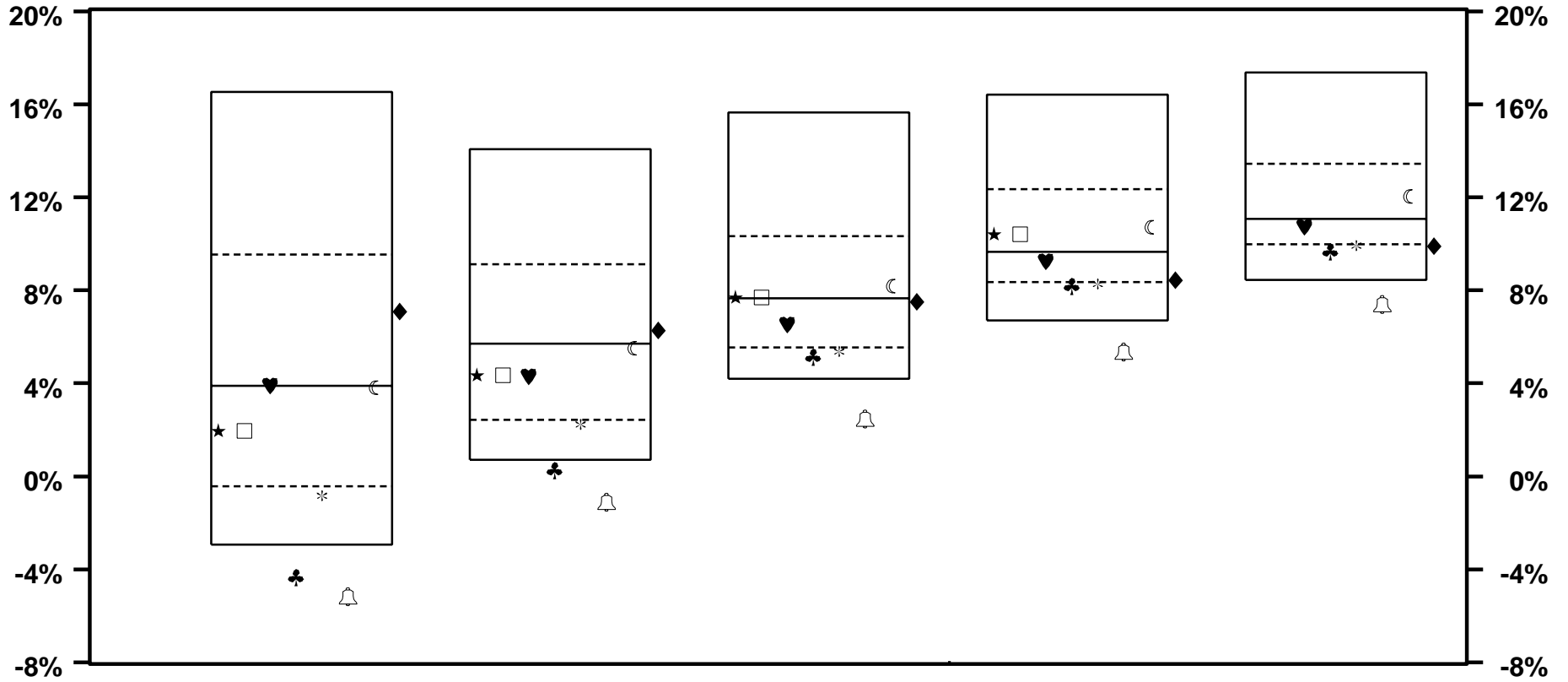

	LAST 6 YEARS		LAST 7 YEARS		LAST 8 YEARS		LAST 9 YEARS		LAST 10 YEARS	
★ MUNI COMPOSITE	2.0	62	4.4	59	7.7	49	10.4	41		
□ EQTY COMPOSITE	2.0	62	4.4	59	7.7	49	10.4	41		
♥ DELAWARE	3.9	49	4.3	59	6.5	64	9.3	58	10.7	58
♣ ALLIANCE	-4.3	97	0.3	96	5.1	89	8.2	83	9.7	85
* S&P 500	-0.8	84	2.2	83	5.4	83	8.3	79	9.9	79
🔔 R 1000(R) GR	-5.2	98	-1.1	98	2.5	98	5.3	97	7.4	98
☾ R 1000(R) VALUE	3.8	50	5.5	51	8.2	42	10.7	39	12.0	39
◆ R 2000(R)	7.1	32	6.3	44	7.5	51	8.5	70	9.9	80
MEDIAN	3.9		5.7		7.7		9.7		11.1	

VERMONT MUNICIPAL EMPLOYEES

EQUITY ONLY - RATES OF RETURN

PERIODS ENDING 6/05

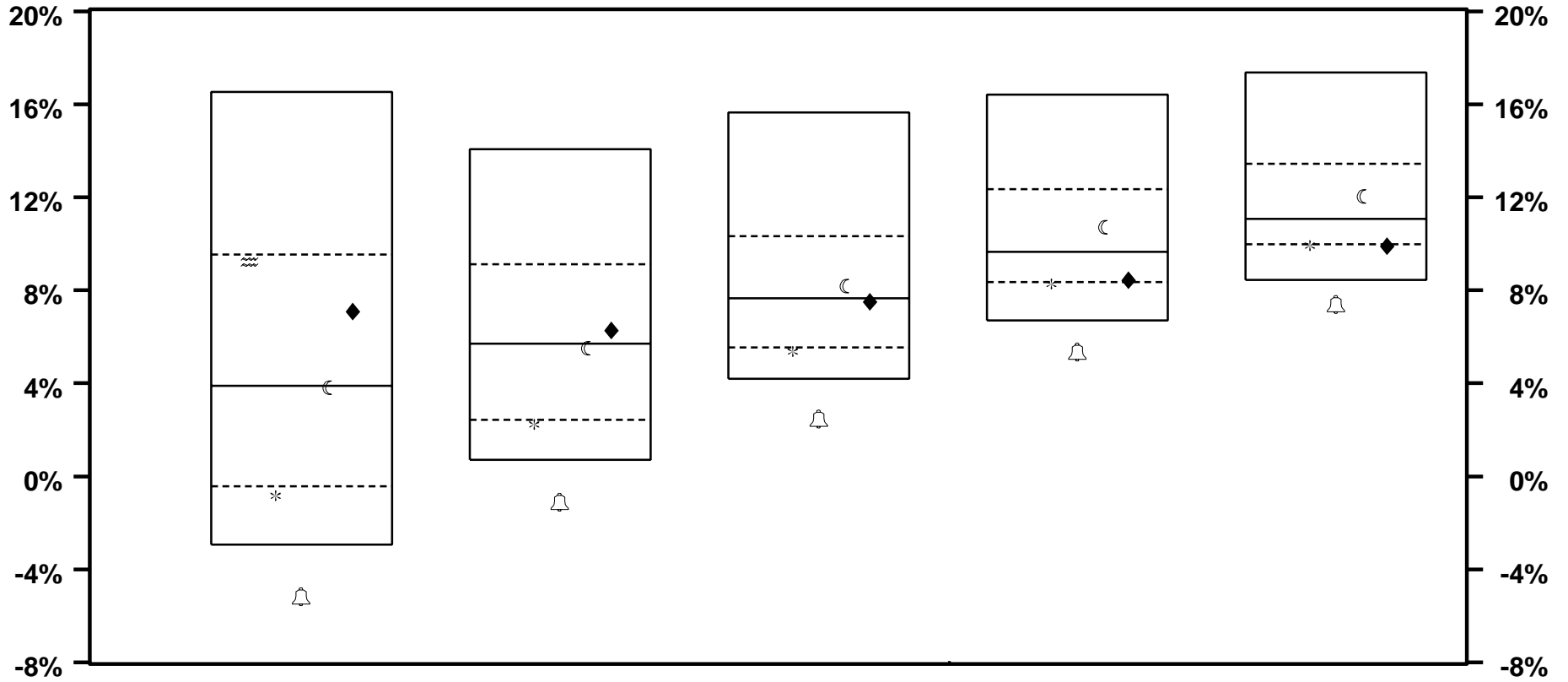

	LAST 6 YEARS		LAST 7 YEARS		LAST 8 YEARS		LAST 9 YEARS		LAST 10 YEARS	
≈ LAZARD	9.2	25								
* S&P 500	-0.8	84	2.2	83	5.4	83	8.3	79	9.9	79
🔔 R 1000(R) GR	-5.2	98	-1.1	98	2.5	98	5.3	97	7.4	98
☾ R 1000(R) VALUE	3.8	50	5.5	51	8.2	42	10.7	39	12.0	39
◆ R 2000(R)	7.1	32	6.3	44	7.5	51	8.5	70	9.9	80
MEDIAN	3.9		5.7		7.7		9.7		11.1	

VERMONT MUNICIPAL EMPLOYEES

EQUITY ONLY - RATES OF RETURN

YEARS ENDING

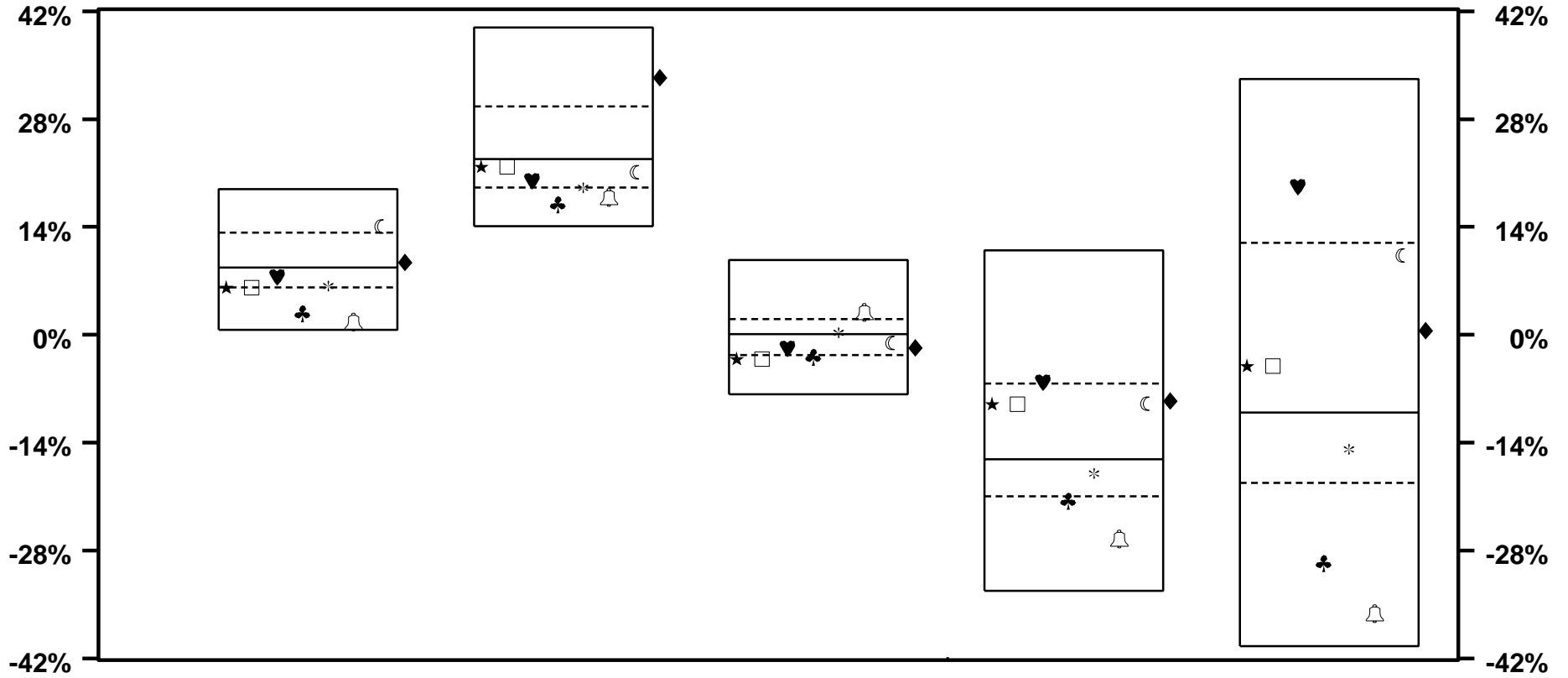

	6 / 05		6 / 04		6 / 03		6 / 02		6 / 01	
★ MUNI COMPOSITE	6.2	74	21.8	54	-3.2	79	-9.0	30	-4.1	43
□ EQTY COMPOSITE	6.2	74	21.8	54	-3.2	79	-9.0	30	-4.1	43
♥ DELAWARE	7.5	57	20.0	64	-1.7	67	-6.1	24	19.3	18
♣ ALLIANCE	2.8	89	16.9	87	-2.8	76	-21.5	76	-29.6	87
* S&P 500	6.3	72	19.1	73	0.3	47	-18.0	61	-14.8	65
🔔 R 1000(R) GR	1.7	93	17.9	83	2.9	20	-26.5	87	-36.2	93
🌙 R 1000(R) VALUE	14.1	18	21.1	58	-1.0	60	-9.0	30	10.3	27
◆ R 2000(R)	9.4	47	33.4	15	-1.6	66	-8.6	29	0.6	39
MEDIAN	8.7		22.8		0.1		-16.1		-10.1	

VERMONT MUNICIPAL EMPLOYEES

EQUITY ONLY - RATES OF RETURN

YEARS ENDING

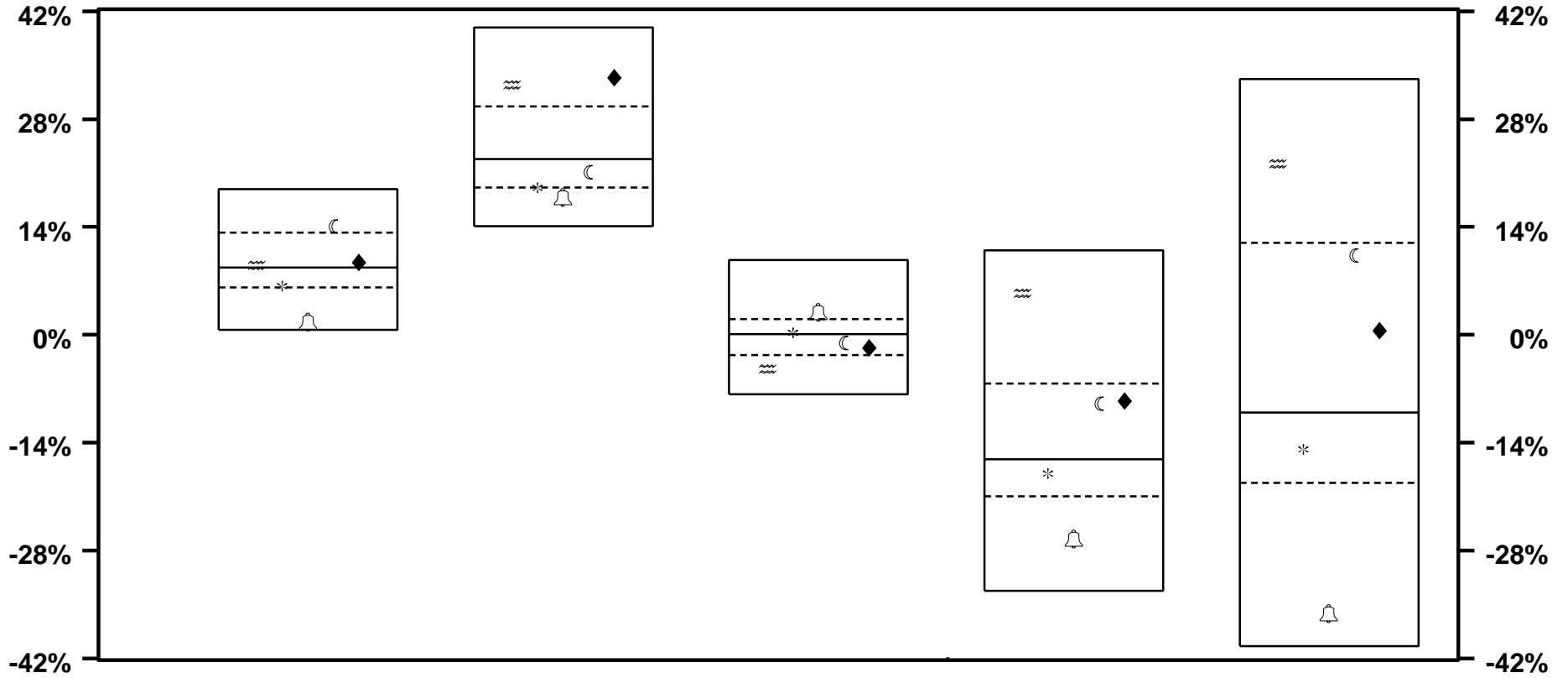

	6 / 05		6 / 04		6 / 03		6 / 02		6 / 01	
≈ LAZARD	9.0	49	32.5	16	-4.4	85	5.4	9	22.2	15
* S&P 500	6.3	72	19.1	73	0.3	47	-18.0	61	-14.8	65
🔔 R 1000(R) GR	1.7	93	17.9	83	2.9	20	-26.5	87	-36.2	93
☾ R 1000(R) VALUE	14.1	18	21.1	58	-1.0	60	-9.0	30	10.3	27
◆ R 2000(R)	9.4	47	33.4	15	-1.6	66	-8.6	29	0.6	39
MEDIAN	8.7		22.8		0.1		-16.1		-10.1	

VERMONT MUNICIPAL EMPLOYEES

EQUITY ONLY - RATES OF RETURN

YEARS ENDING

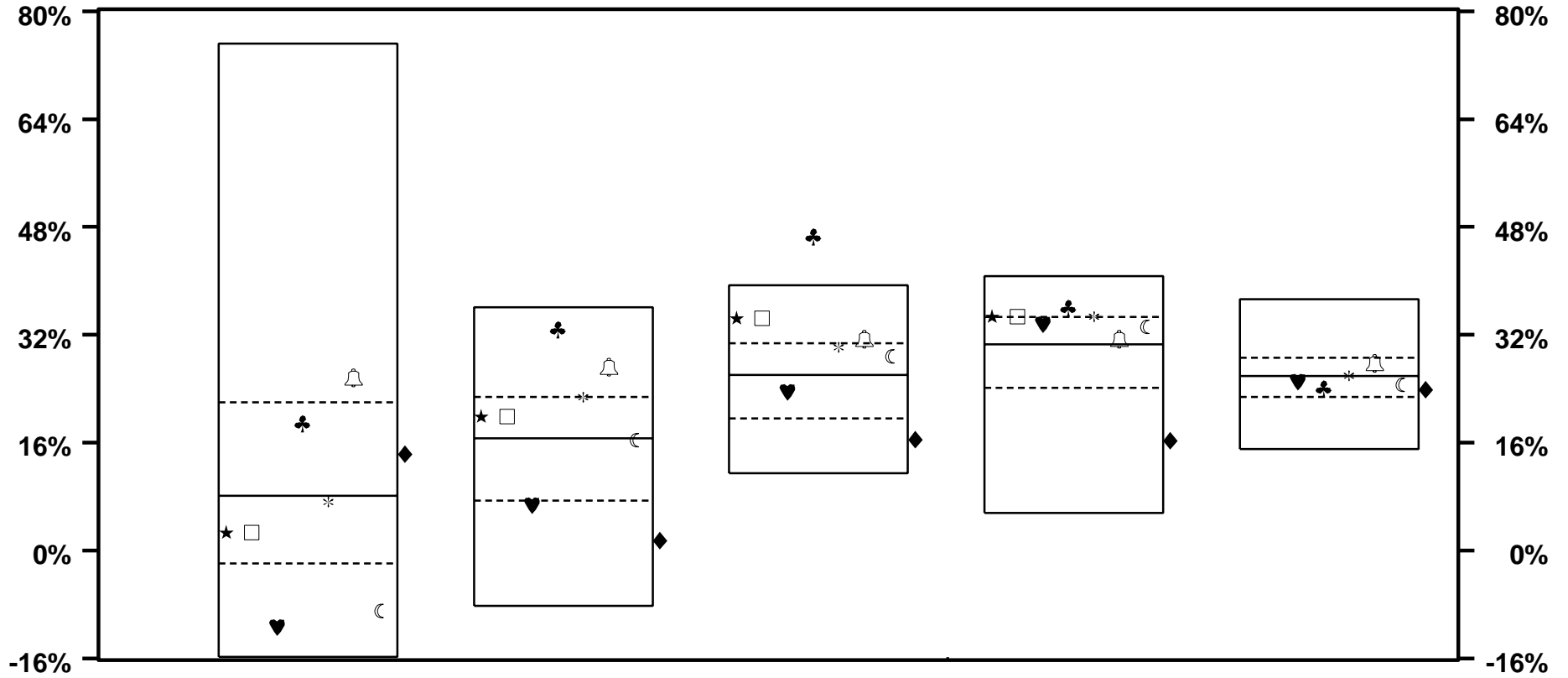

	6 / 00		6 / 99		6 / 98		6 / 97		6 / 96	
★ MUNI COMPOSITE	2.7	69	19.9	38	34.5	12	34.7	24		
□ EQTY COMPOSITE	2.7	69	19.9	38	34.5	12	34.7	24		
♥ DELAWARE	- 11.3	91	6.7	76	23.5	59	33.6	32	25.1	58
♣ ALLIANCE	18.9	30	32.8	6	46.6	1	36.0	15	24.0	66
* S&P 500	7.3	56	22.8	26	30.2	30	34.7	24	25.9	48
🔔 R 1000(R) GR	25.6	20	27.3	12	31.4	21	31.3	45	27.8	29
☾ R 1000(R) VALUE	- 8.9	86	16.4	51	28.8	40	33.2	34	24.6	61
◆ R 2000(R)	14.3	37	1.5	83	16.5	86	16.3	86	23.9	67
MEDIAN	8.1		16.7		26.1		30.6		25.9	

VERMONT MUNICIPAL EMPLOYEES

EQUITY ONLY - RATES OF RETURN

YEARS ENDING

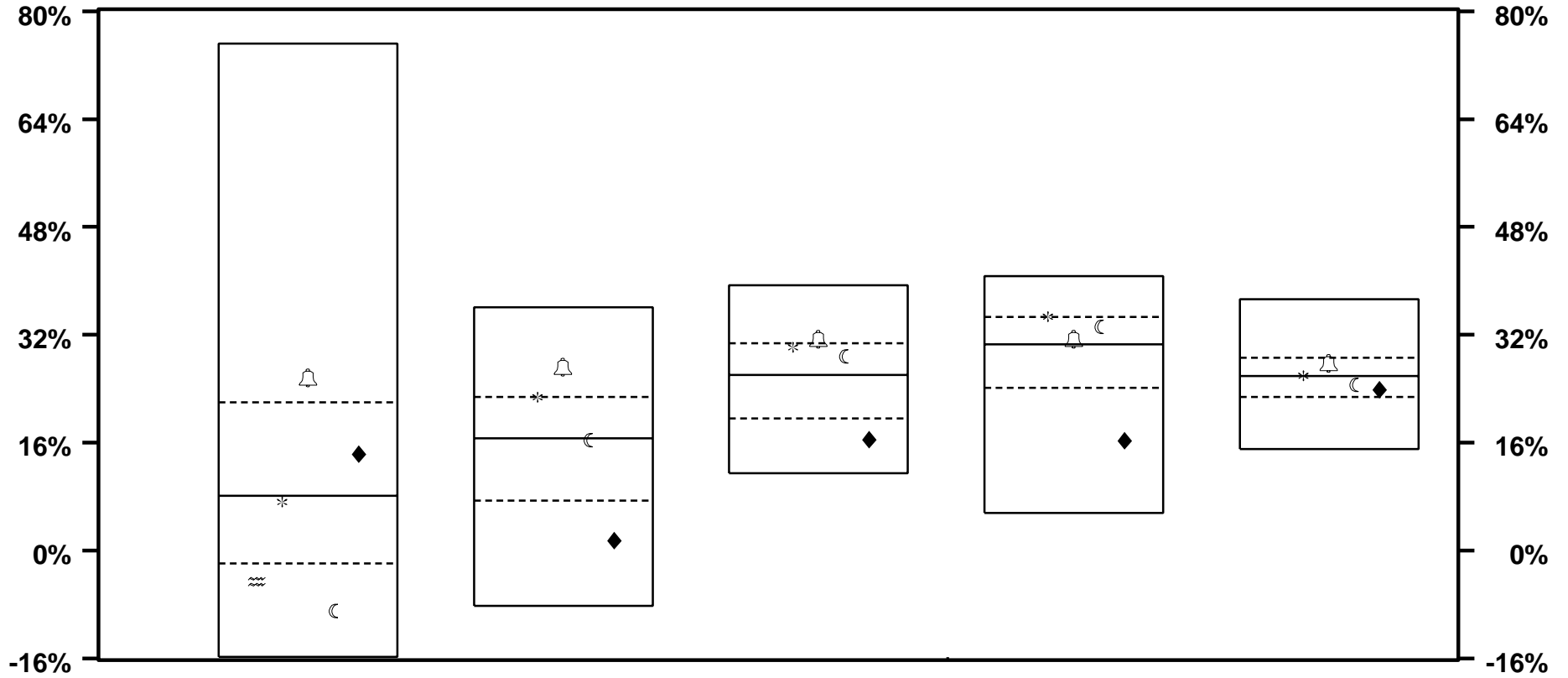

	6 / 00		6 / 99		6 / 98		6 / 97		6 / 96	
≡ LAZARD	- 4.5	79								
* S&P 500	7.3	56	22.8	26	30.2	30	34.7	24	25.9	48
🔔 R 1000(R) GR	25.6	20	27.3	12	31.4	21	31.3	45	27.8	29
Ⓒ R 1000(R) VALUE	- 8.9	86	16.4	51	28.8	40	33.2	34	24.6	61
◆ R 2000(R)	14.3	37	1.5	83	16.5	86	16.3	86	23.9	67
MEDIAN	8.1		16.7		26.1		30.6		25.9	

VERMONT MUNICIPAL EMPLOYEES

EQUITY ONLY - ACTIVELY MANAGED - PURCHASES & SALES TURNOVER

PERIODS ENDING 6/05

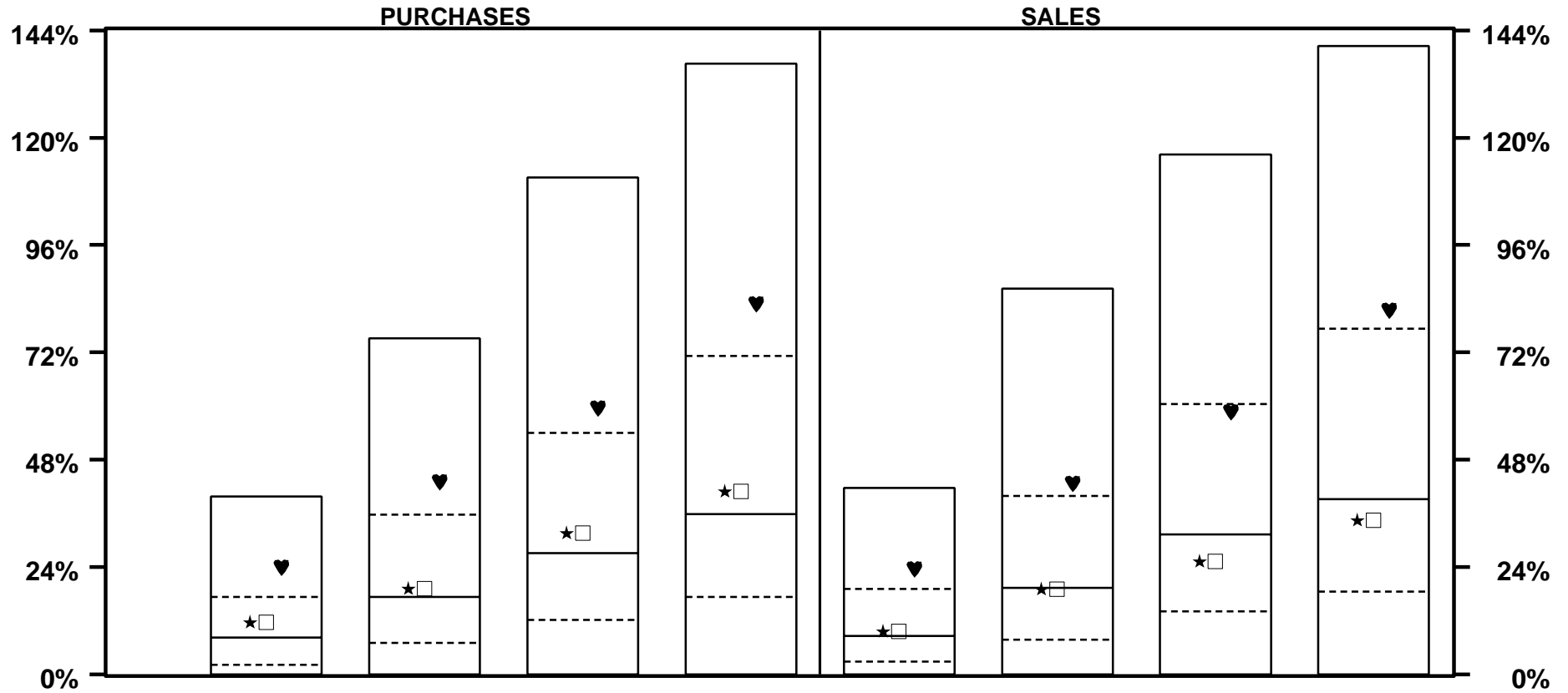

	LAST QTR		LAST 2 QTRS		LAST 3 QTRS		LAST YEAR		LAST QTR		LAST 2 QTRS		LAST 3 QTRS		LAST YEAR	
★ MUNI COMPOSITE	11.6	38	19.1	46	31.6	45	41.0	45	9.6	46	19.0	50	25.3	55	34.5	54
□ EQTY COMPOSITE	11.6	38	19.1	46	31.6	45	41.0	45	9.6	46	19.0	50	25.3	55	34.5	54
♥ DELAWARE	24.0	14	43.1	18	59.6	21	82.9	19	23.7	17	42.8	22	58.7	25	81.5	22
MEDIAN	8.2		17.3		27.1		35.9		8.6		19.3		31.2		39.2	

VERMONT MUNICIPAL EMPLOYEES

EQUITY ONLY - BUY & HOLD VS ACTUAL RETURNS

PERIODS ENDING 6/05

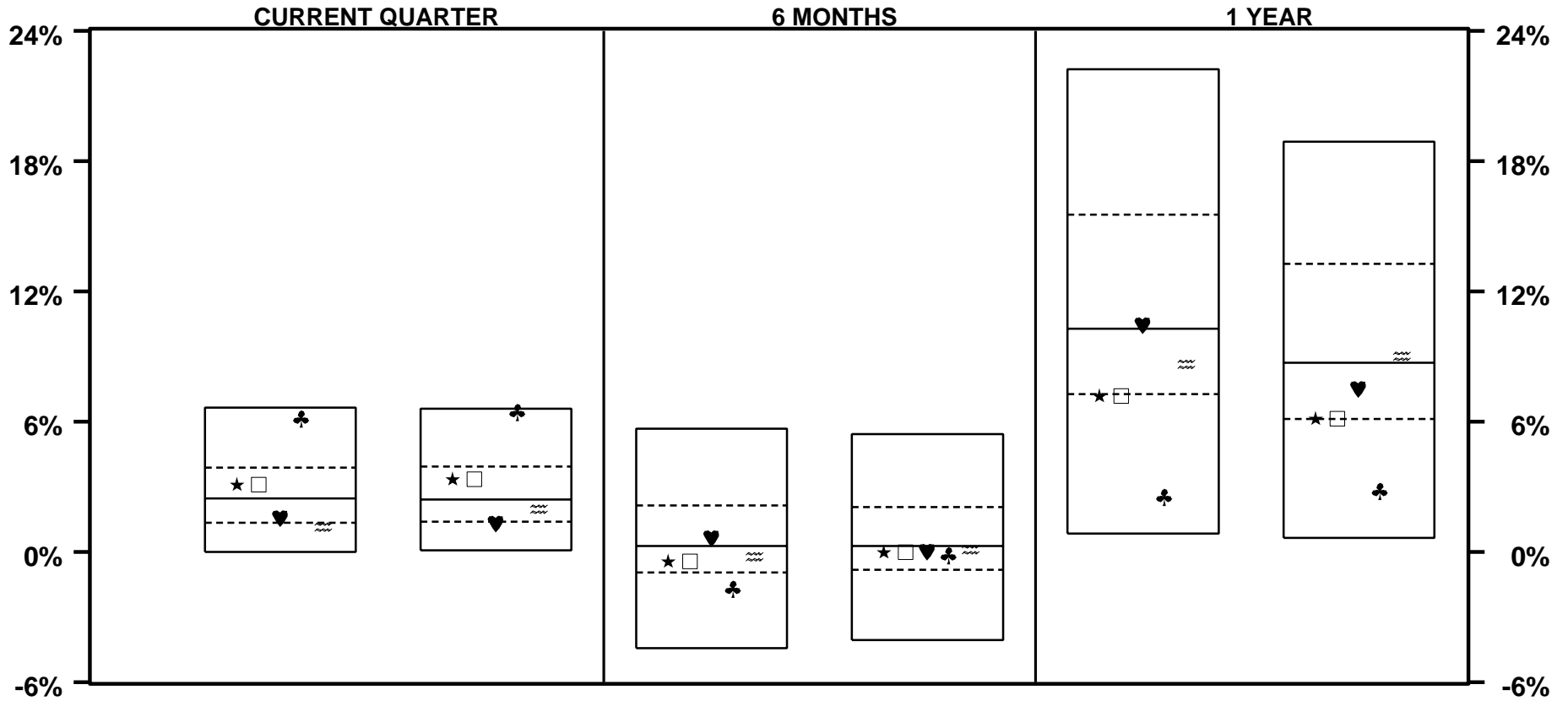

	BUY & HOLD		EQUITY ONLY		BUY & HOLD		EQUITY ONLY		BUY & HOLD		EQUITY ONLY	
★ MUNI COMPOSITE	3.1	37	3.3	33	-0.4	62	0.0	56	7.2	75	6.2	74
□ EQTY COMPOSITE	3.1	37	3.3	33	-0.4	62	0.0	56	7.2	75	6.2	74
♥ DELAWARE	1.6	68	1.3	80	0.6	44	0.0	55	10.4	48	7.5	57
♣ ALLIANCE	6.1	6	6.4	5	-1.7	82	-0.2	58	2.5	90	2.8	89
≈ LAZARD	1.2	82	2.0	60	-0.2	60	0.1	53	8.7	59	9.0	49
MEDIAN	2.5		2.4		0.3		0.3		10.3		8.7	

VERMONT MUNICIPAL EMPLOYEES

EQUITY ONLY RETURNS VS RISK

3 YEARS ENDING 6/05

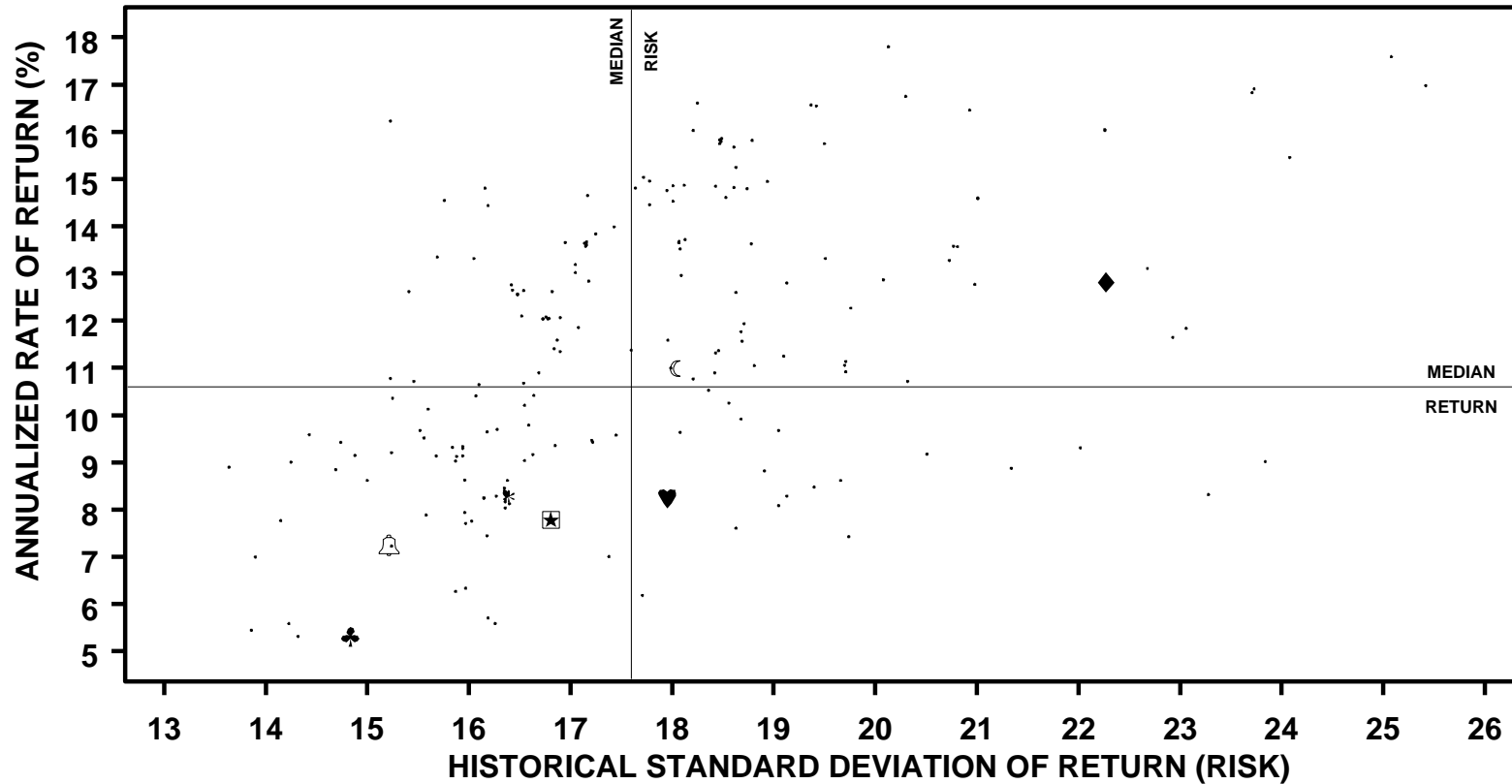

	ANNUALIZED RETURN		STANDARD DEVIATION		SHARPE RATIO	
	VALUE	RANK	VALUE	RANK	VALUE	RANK
★ MUNI COMPOSITE	7.8	83	16.8	59	0.4	82
□ EQTY COMPOSITE	7.8	83	16.8	59	0.4	82
♥ DELAWARE	8.2	79	18.0	44	0.5	81
♣ ALLIANCE	5.3	94	14.8	88	0.3	94
* S&P 500	8.3	78	16.4	68	0.5	71
🔔 R 1000(R) GR	7.3	87	15.2	86	0.4	83
☾ R 1000(R) VALUE	11.0	46	18.0	43	0.6	44
◆ R 2000(R)	12.8	32	22.3	12	0.6	44
MEDIAN	10.6		17.6		0.6	

VERMONT MUNICIPAL EMPLOYEES

EQUITY ONLY RETURNS VS RISK

3 YEARS ENDING 6/05

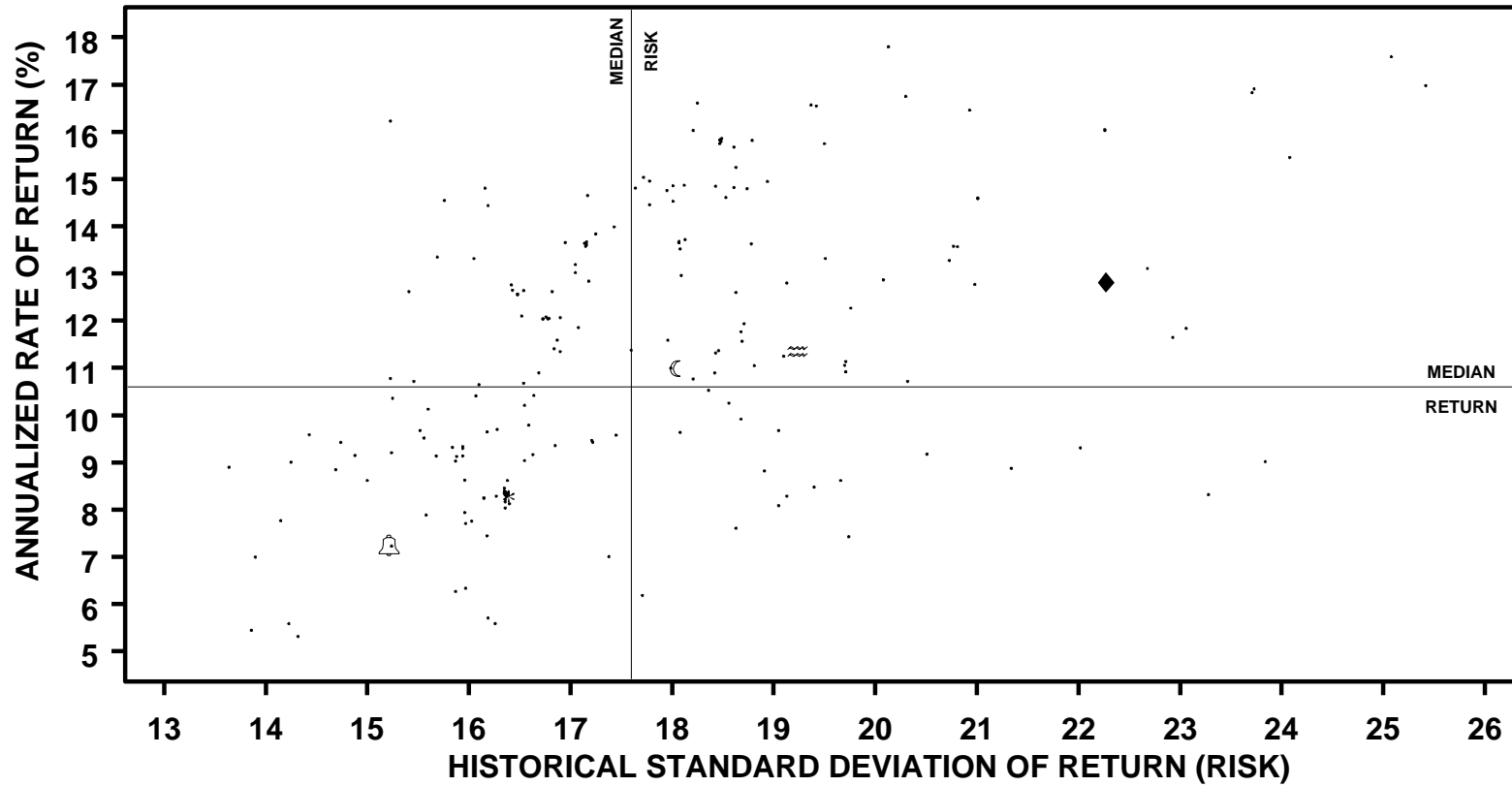

	ANNUALIZED RETURN		STANDARD DEVIATION		SHARPE RATIO	
	VALUE	RANK	VALUE	RANK	VALUE	RANK
≈ LAZARD	11.4	44	19.2	32	0.6	46
* S&P 500	8.3	78	16.4	68	0.5	71
🔔 R 1000(R) GR	7.3	87	15.2	86	0.4	83
☾ R 1000(R) VALUE	11.0	46	18.0	43	0.6	44
◆ R 2000(R)	12.8	32	22.3	12	0.6	44
MEDIAN	10.6		17.6		0.6	

VERMONT MUNICIPAL EMPLOYEES

EQUITY ONLY RETURNS VS RISK

5 YEARS ENDING 6/05

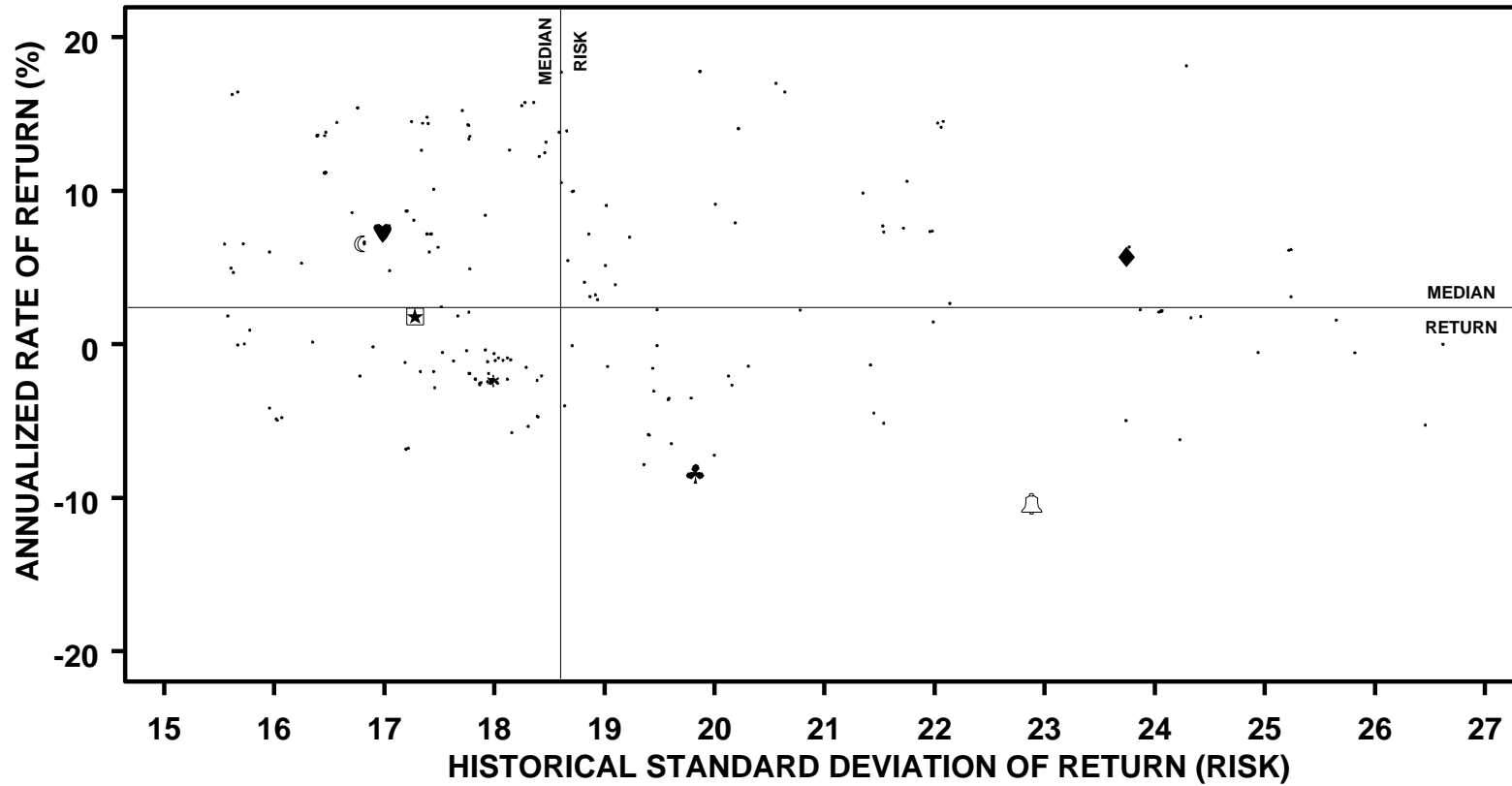

	ANNUALIZED RETURN		STANDARD DEVIATION		SHARPE RATIO	
	VALUE	RANK	VALUE	RANK	VALUE	RANK
★ MUNI COMPOSITE	1.8	52	17.3	79	0.0	54
□ EQTY COMPOSITE	1.8	52	17.3	79	0.0	54
♥ DELAWARE	7.3	33	17.0	82	0.3	33
♣ ALLIANCE	-8.4	96	19.8	38	-0.5	
* S&P 500	-2.4	77	18.0	59	-0.2	
🔔 R 1000(R) GR	-10.4	97	22.9	21	-0.5	
☾ R 1000(R) VALUE	6.6	36	16.8	83	0.3	35
♦ R 2000(R)	5.7	40	23.7	19	0.2	40
MEDIAN	2.4		18.6		0.1	

VERMONT MUNICIPAL EMPLOYEES

EQUITY ONLY RETURNS VS RISK

5 YEARS ENDING 6/05

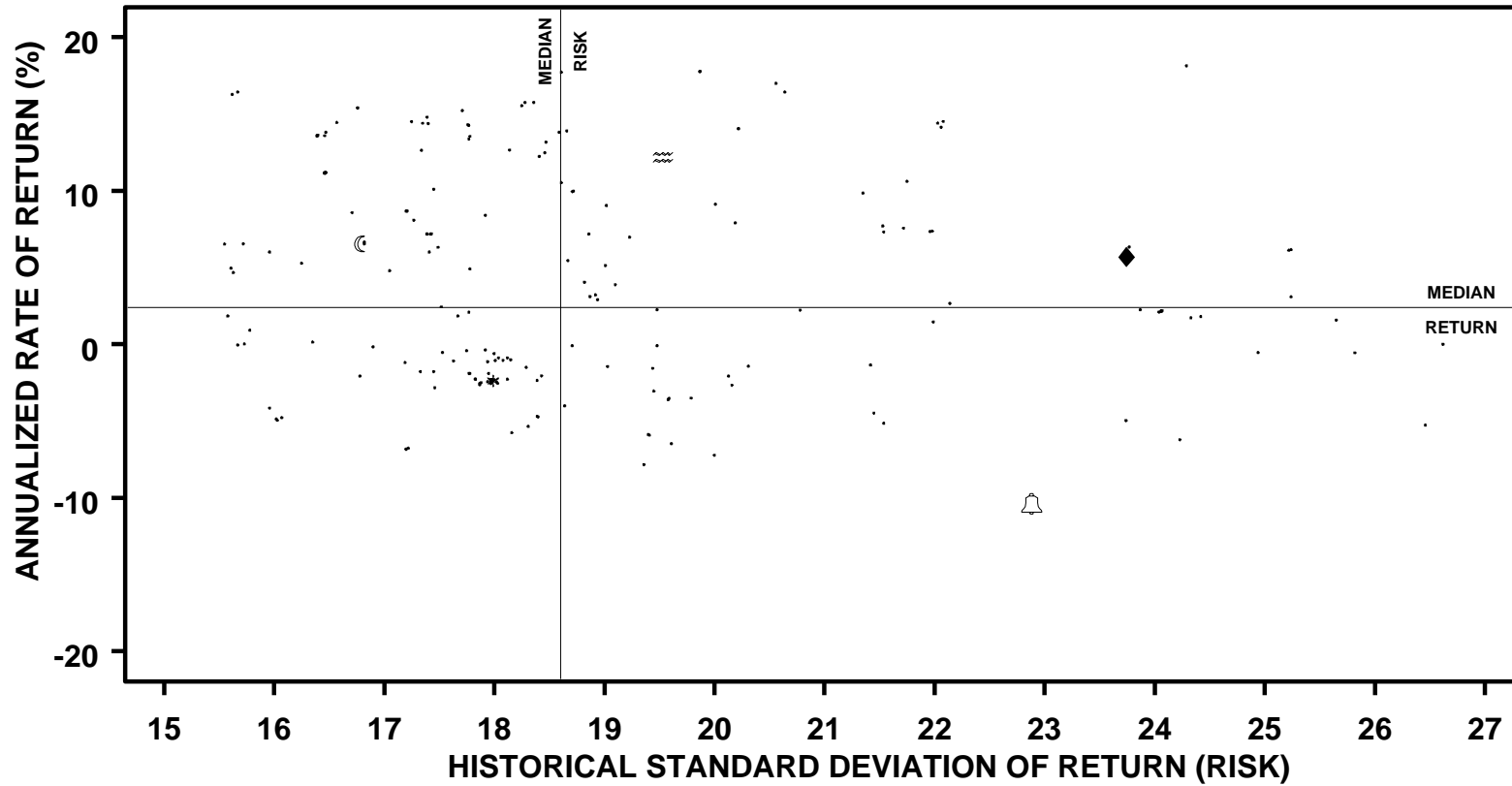

	ANNUALIZED RETURN		STANDARD DEVIATION		SHARPE RATIO	
	VALUE	RANK	VALUE	RANK	VALUE	RANK
≈ LAZARD	12.2	20	19.5	40	0.6	20
* S&P 500	-2.4	77	18.0	59	-0.2	
🔔 R 1000(R) GR	-10.4	97	22.9	21	-0.5	
☾ R 1000(R) VALUE	6.6	36	16.8	83	0.3	35
◆ R 2000(R)	5.7	40	23.7	19	0.2	40
MEDIAN	2.4		18.6		0.1	

VERMONT MUNICIPAL EMPLOYEES

COMBINED EQUITY FUNDS - TOTAL RATES OF RETURN

PERIODS ENDING 6/05

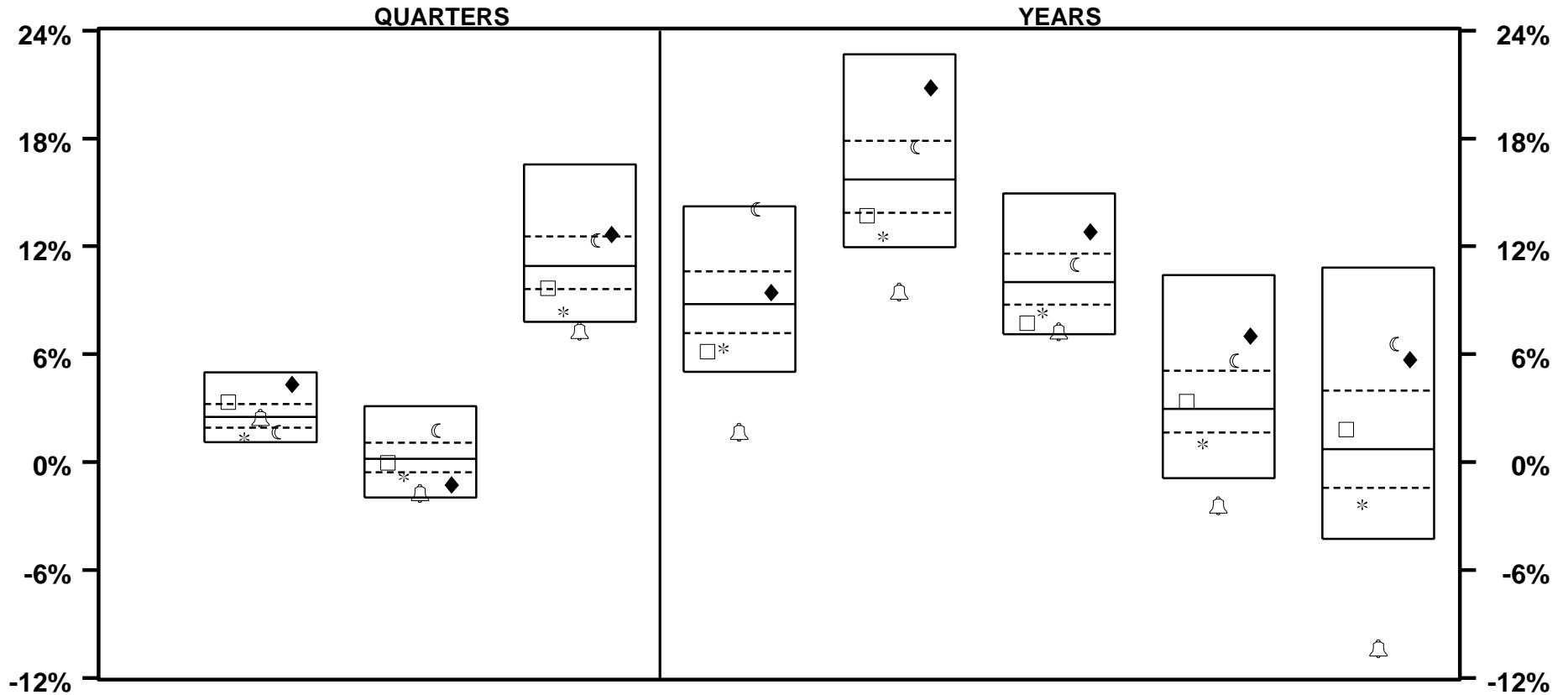

	LAST QTR		LAST 2 QTRS		LAST 3 QTRS		LAST YEAR		LAST 2 YEARS		LAST 3 YEARS		LAST 4 YEARS		LAST 5 YEARS	
□ EQTY COMPOSITE	3.3	21	0.0	56	9.7	74	6.1	87	13.7	77	7.7	90	3.4	44	1.8	38
* S&P 500	1.4	91	-0.8	82	8.3	90	6.3	86	12.5	90	8.3	83	1.0	83	-2.4	85
🔔 R 1000(R) GR	2.5	52	-1.7	94	7.3	96	1.7	99	9.5	99	7.3	93	-2.4	98	-10.4	99
☾ R 1000(R) VALUE	1.7	82	1.8	12	12.3	27	14.1	5	17.5	27	11.0	32	5.6	20	6.6	15
◆ R 2000(R)	4.3	8	-1.3	90	12.7	23	9.4	41	20.8	12	12.8	13	7.0	14	5.7	17
MEDIAN	2.5		0.2		10.9		8.8		15.7		10.0		3.0		0.7	

VERMONT MUNICIPAL EMPLOYEES

COMBINED EQUITY FUNDS - TOTAL RATES OF RETURN

PERIODS ENDING 6/05

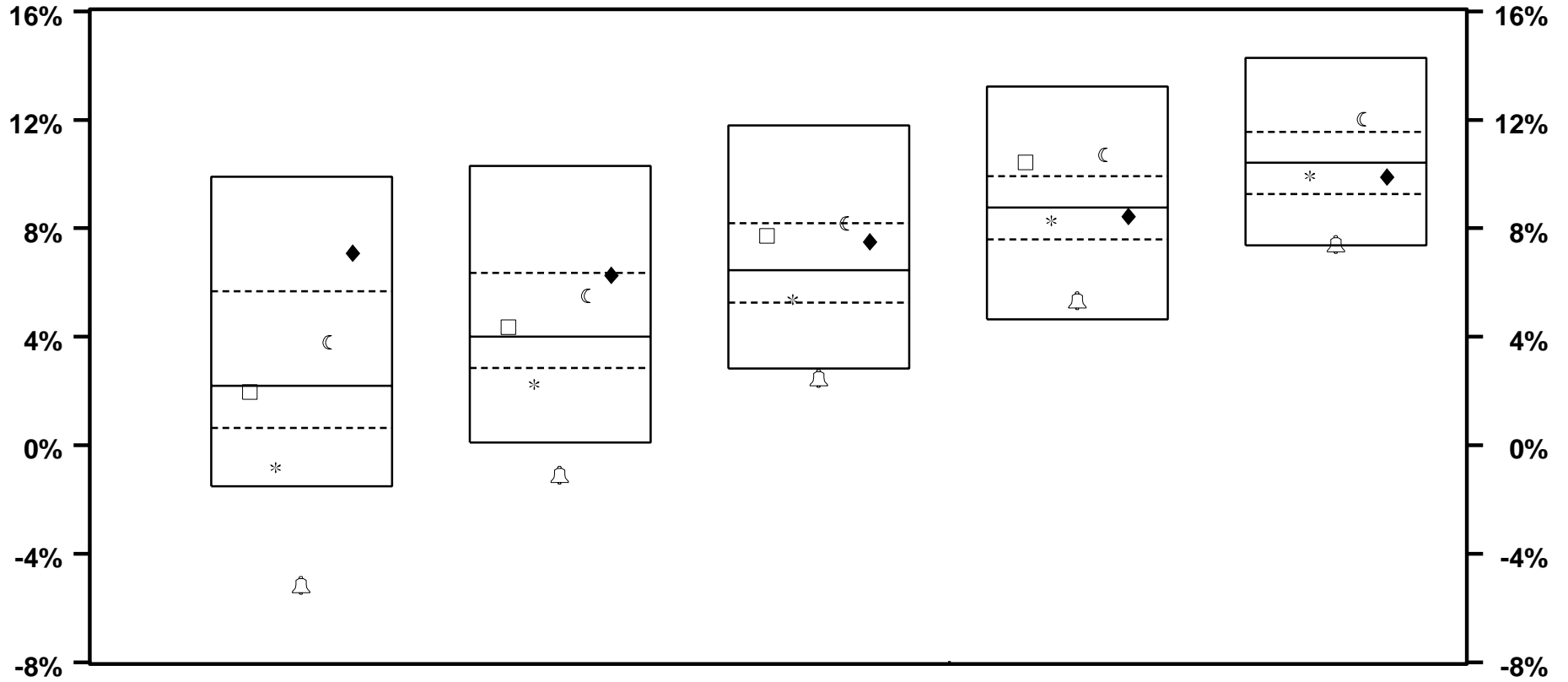

	LAST 6 YEARS		LAST 7 YEARS		LAST 8 YEARS		LAST 9 YEARS		LAST 10 YEARS	
□ EQTY COMPOSITE	2.0	53	4.4	43	7.7	31	10.4	21		
* S&P 500	-0.8	92	2.2	84	5.4	72	8.3	63	9.9	63
🔔 R 1000(R) GR	-5.2	100	-1.1	97	2.5	96	5.3	93	7.4	94
☾ R 1000(R) VALUE	3.8	34	5.5	31	8.2	25	10.7	17	12.0	20
◆ R 2000(R)	7.1	17	6.3	25	7.5	35	8.5	58	9.9	64
MEDIAN	2.2		4.0		6.5		8.8		10.4	

VERMONT MUNICIPAL EMPLOYEES

COMBINED EQUITY FUNDS - TOTAL RATES OF RETURN

YEARS ENDING

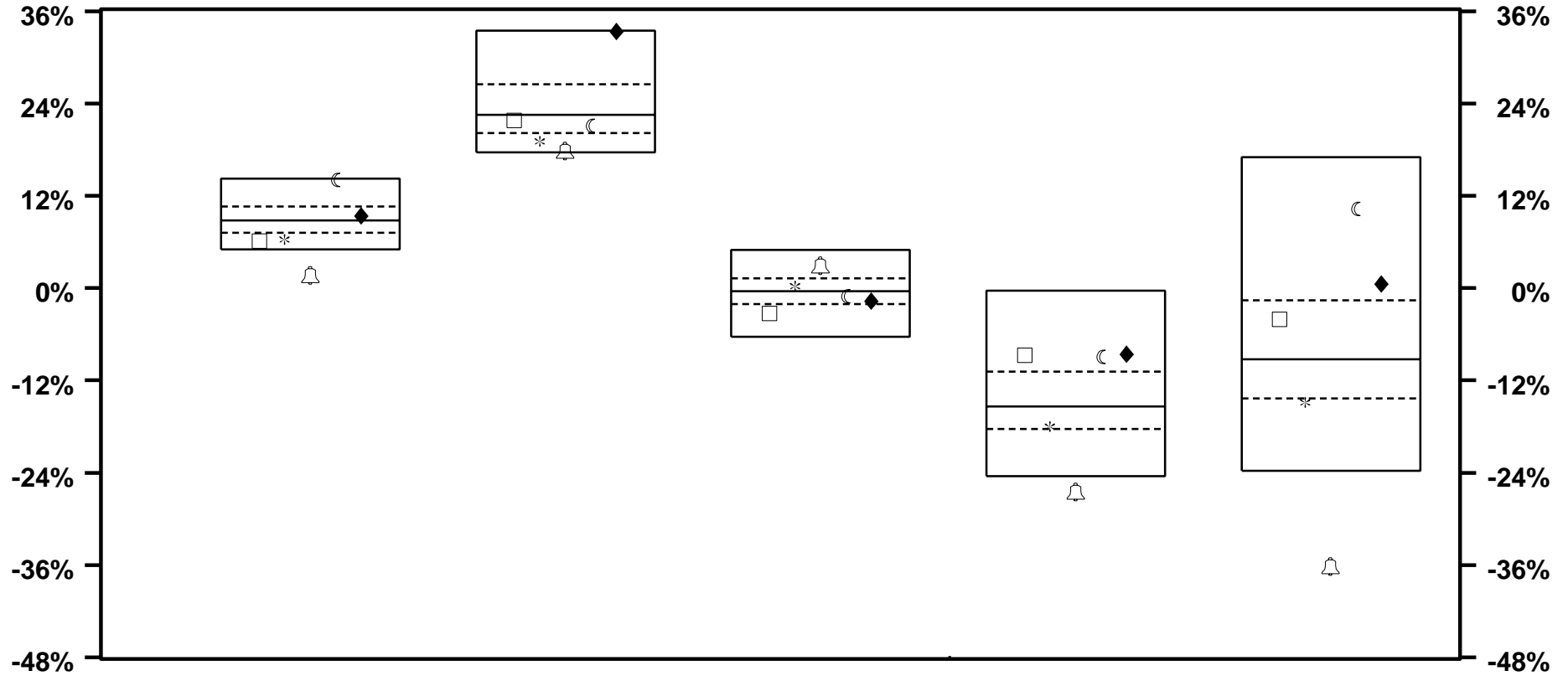

	6 / 05		6 / 04		6 / 03		6 / 02		6 / 01	
□ EQTY COMPOSITE	6.1	87	21.8	58	-3.3	87	-8.7	19	-4.1	32
* S&P 500	6.3	86	19.1	84	0.3	39	-18.0	71	-14.8	77
🔔 R 1000(R) GR	1.7	99	17.9	94	2.9	12	-26.5	96	-36.2	99
☾ R 1000(R) VALUE	14.1	5	21.1	65	-1.0	60	-9.0	19	10.3	9
◆ R 2000(R)	9.4	41	33.4	5	-1.6	69	-8.6	19	0.6	21
MEDIAN	8.8		22.6		-0.4		-15.4		-9.2	

VERMONT MUNICIPAL EMPLOYEES

COMBINED EQUITY FUNDS - TOTAL RATES OF RETURN

YEARS ENDING

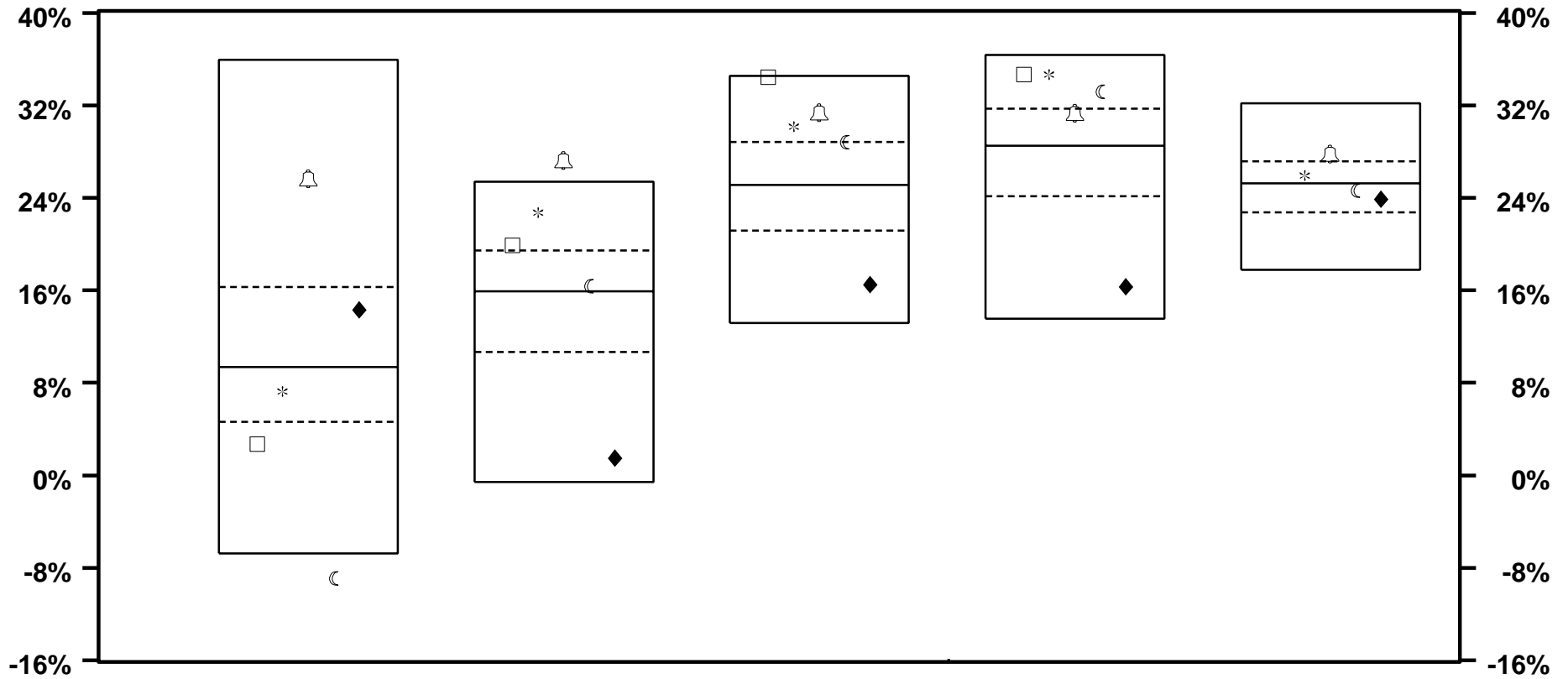

	6 / 00		6 / 99		6 / 98		6 / 97		6 / 96	
□ EQTY COMPOSITE	2.7	81	19.9	22	34.5	5	34.7	8		
* S&P 500	7.3	62	22.8	11	30.2	16	34.7	8	25.9	39
🔔 R 1000(R) GR	25.6	12	27.3	3	31.4	9	31.3	26	27.8	17
☾ R 1000(R) VALUE	-8.9	96	16.4	47	28.8	24	33.2	15	24.6	56
◆ R 2000(R)	14.3	30	1.5	92	16.5	90	16.3	91	23.9	63
MEDIAN	9.3		15.9		25.1		28.5		25.3	

VERMONT MUNICIPAL EMPLOYEES

COMBINED EQUITY FUNDS - TOTAL RETURN VS RISK

3 YEARS ENDING 6/05

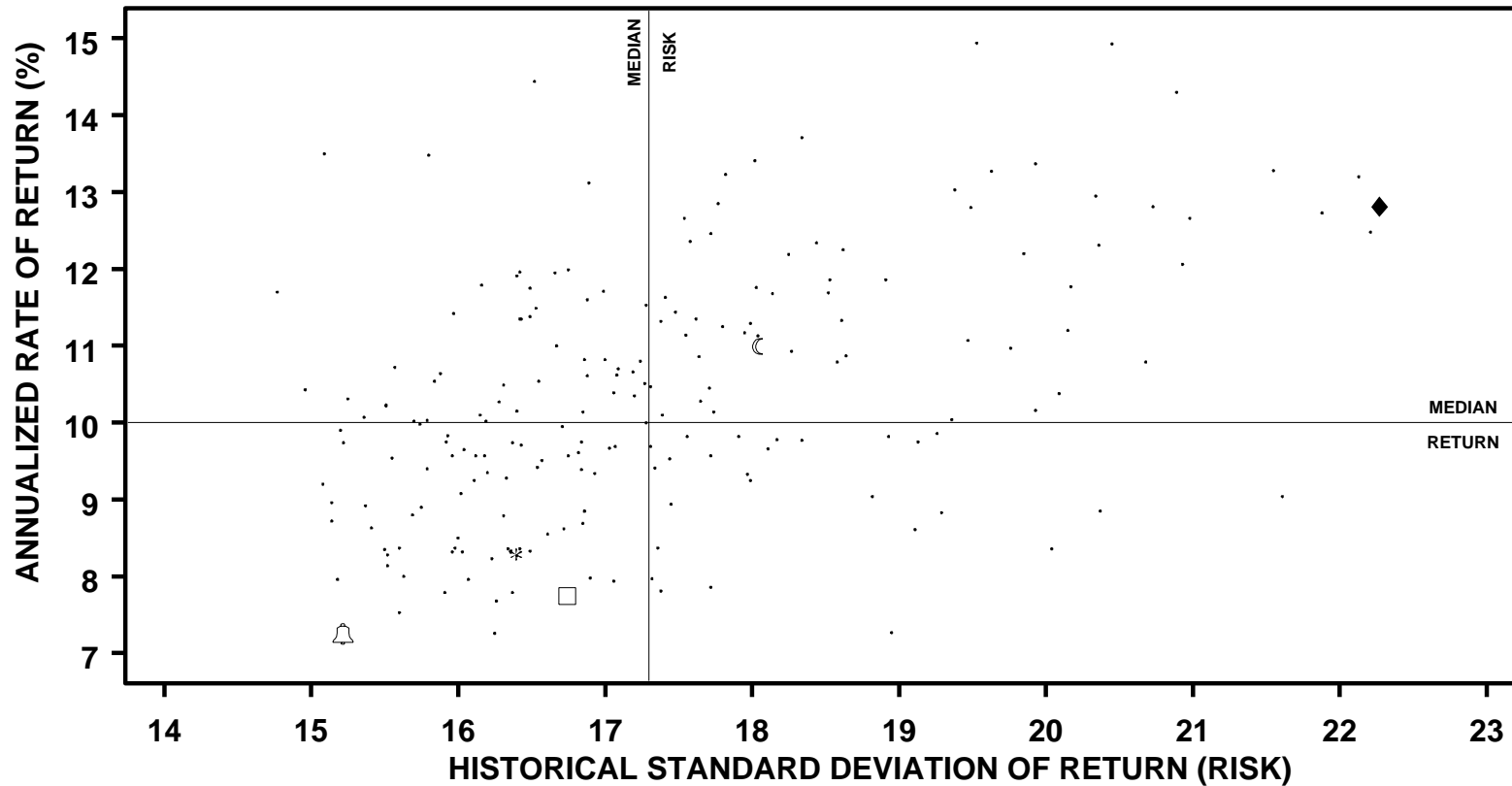

	ANNUALIZED RETURN		STANDARD DEVIATION		SHARPE RATIO	
	VALUE	RANK	VALUE	RANK	VALUE	RANK
□ EQTY COMPOSITE	7.7	90	16.7	62	0.4	89
* S&P 500	8.3	83	16.4	71	0.5	79
🔔 R 1000(R) GR	7.3	93	15.2	93	0.4	90
☾ R 1000(R) VALUE	11.0	32	18.0	32	0.6	37
◆ R 2000(R)	12.8	13	22.3	6	0.6	36
MEDIAN	10.0		17.3		0.6	

VERMONT MUNICIPAL EMPLOYEES

COMBINED EQUITY FUNDS - TOTAL RETURN VS RISK

5 YEARS ENDING 6/05

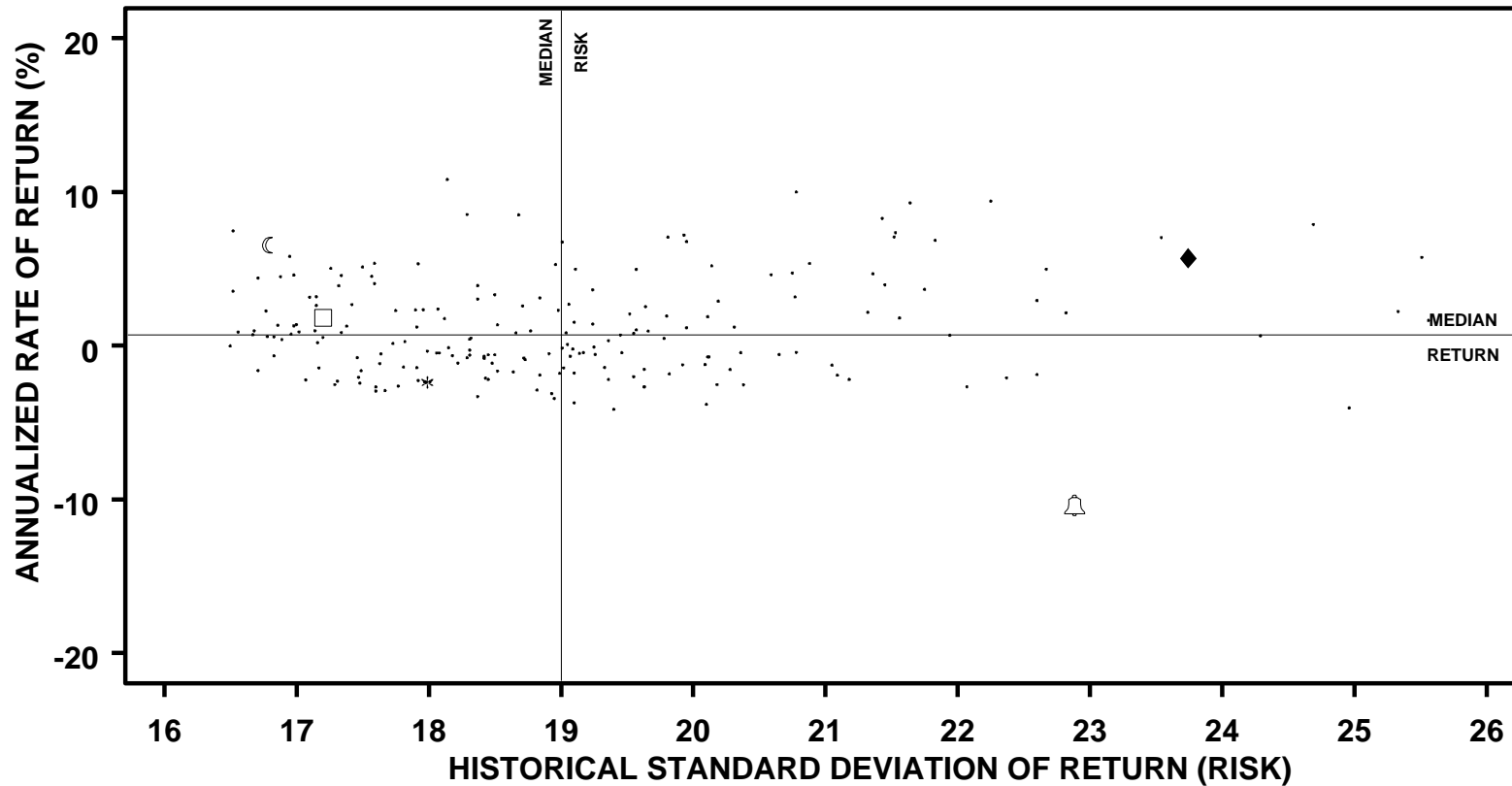

	ANNUALIZED RETURN		STANDARD DEVIATION		SHARPE RATIO	
	VALUE	RANK	VALUE	RANK	VALUE	RANK
□ EQTY COMPOSITE	1.8	38	17.2	83	0.0	39
* S&P 500	-2.4	85	18.0	70	-0.2	
🔔 R 1000(R) GR	-10.4	99	22.9	10	-0.5	
☾ R 1000(R) VALUE	6.6	15	16.8	91	0.3	13
◆ R 2000(R)	5.7	17	23.7	9	0.2	17
MEDIAN	0.7		19.0		0.0	

VERMONT MUNICIPAL EMPLOYEES

BOND FUNDS - TOTAL RATES OF RETURN

PERIODS ENDING 6/05

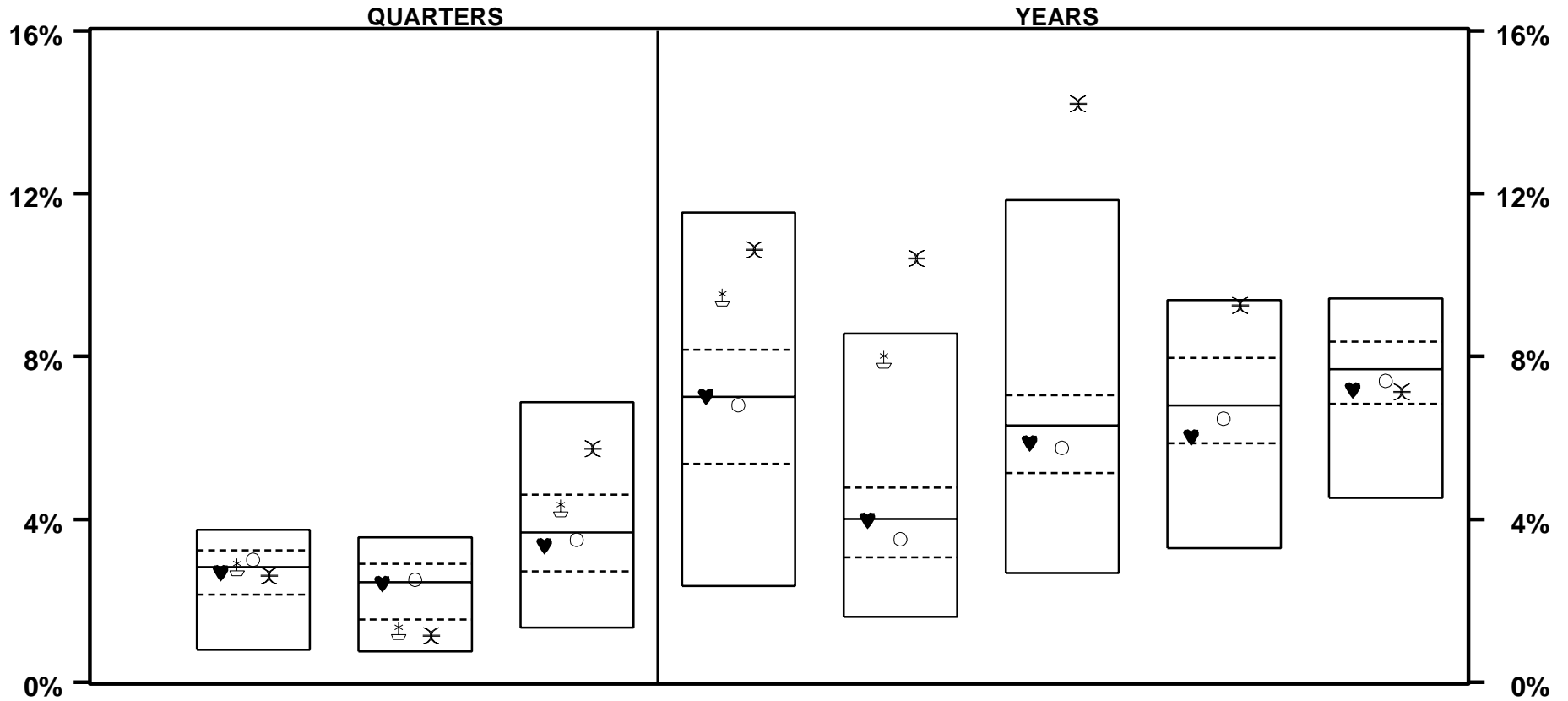

	LAST QTR		LAST 2 QTRS		LAST 3 QTRS		LAST YEAR		LAST 2 YEARS		LAST 3 YEARS		LAST 4 YEARS		LAST 5 YEARS	
♥ SEIX CORE	2.7	55	2.4	51	3.4	64	7.0	49	4.0	50	5.9	60	6.0	71	7.2	66
⊠ SEIX HIGH YIELD	2.8	50	1.3	82	4.3	32	9.5	10	7.9	7						
○ LB AGGREGATE	3.0	40	2.5	45	3.5	58	6.8	56	3.5	64	5.8	64	6.5	61	7.4	60
⌘ ML HIGH YLD II	2.6	58	1.1	85	5.7	7	10.6	5	10.4	1	14.2	1	9.3	5	7.1	67
MEDIAN	2.8		2.5		3.7		7.0		4.0		6.3		6.8		7.7	

VERMONT MUNICIPAL EMPLOYEES

BOND FUNDS - TOTAL RATES OF RETURN

YEARS ENDING

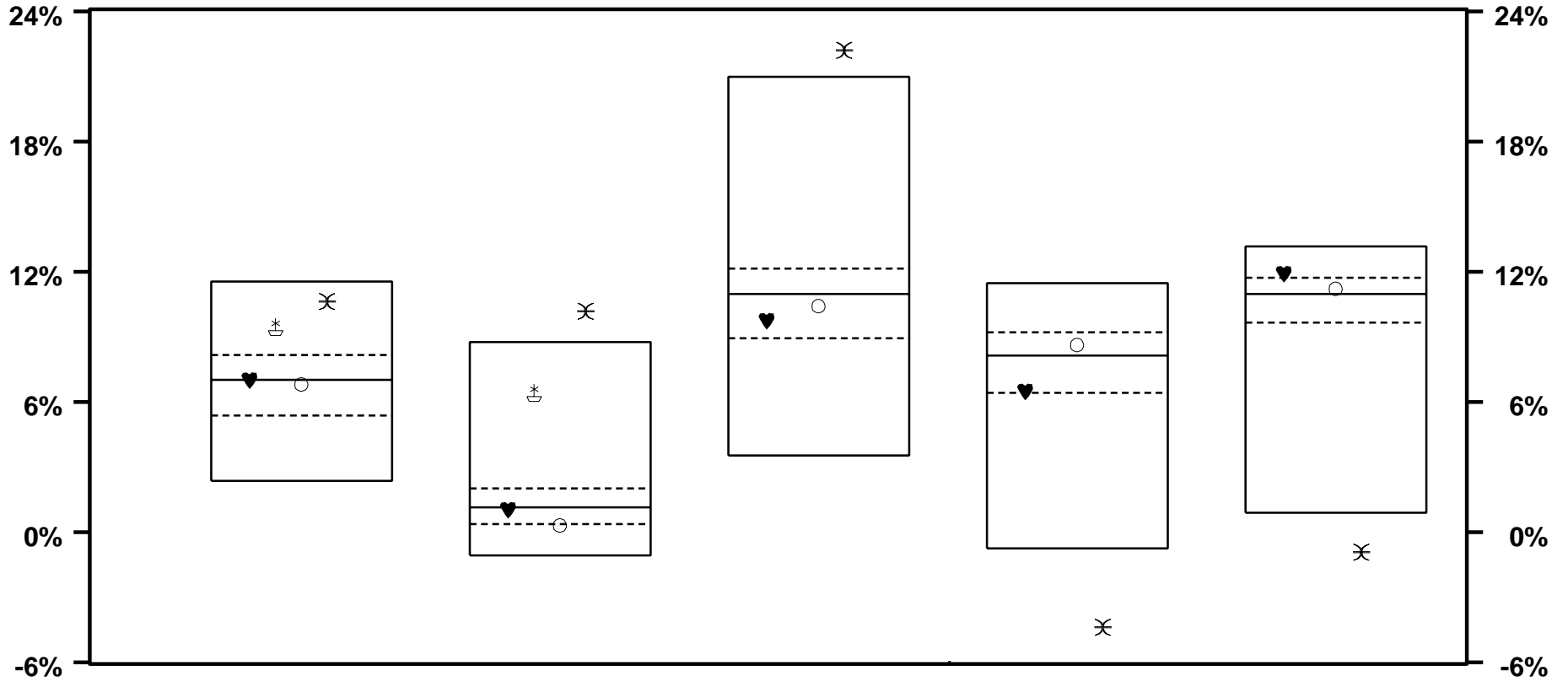

	6 / 05		6 / 04		6 / 03		6 / 02		6 / 01	
♥ SEIX CORE	7.0	49	1.0	53	9.8	68	6.5	74	11.9	20
⊕ SEIX HIGH YIELD	9.5	10	6.4	10						
○ LB AGGREGATE	6.8	56	0.3	76	10.4	59	8.6	37	11.2	41
✧ ML HIGH YLD II	10.6	5	10.2	2	22.2	4	-4.4	97	-0.9	96
MEDIAN	7.0		1.2		11.0		8.1		11.0	

VERMONT MUNICIPAL EMPLOYEES

BOND FUNDS - TOTAL VS BOND ONLY RETURNS

MARKET CYCLE PERFORMANCE COMPARISONS

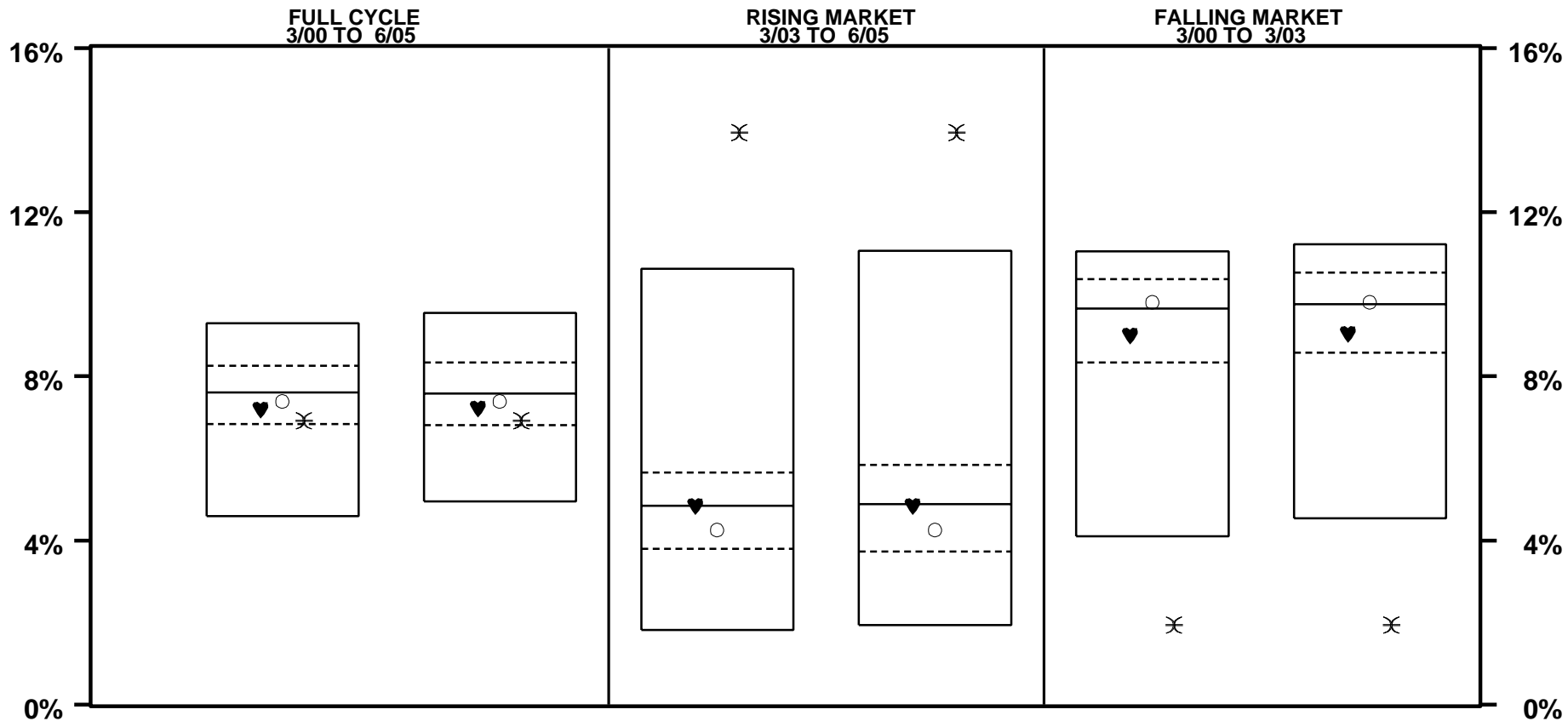

	TOTAL FUND		BONDS ONLY		TOTAL FUND		BONDS ONLY		TOTAL FUND		BONDS ONLY	
♥ SEIX CORE	7.2	65	7.2	63	4.8	50	4.8	51	9.0	66	9.0	67
○ LB AGGREGATE	7.4	58	7.4	58	4.3	65	4.3	64	9.8	44	9.8	47
⌘ ML HIGH YLD II	6.9	73	6.9	71	13.9	1	13.9	1	1.9	97	1.9	97
MEDIAN	7.6		7.6		4.9		4.9		9.7		9.8	

VERMONT MUNICIPAL EMPLOYEES

BOND FUNDS - TOTAL FUND INCOME RATES OF RETURN FOR PERIOD ENDING 6/05

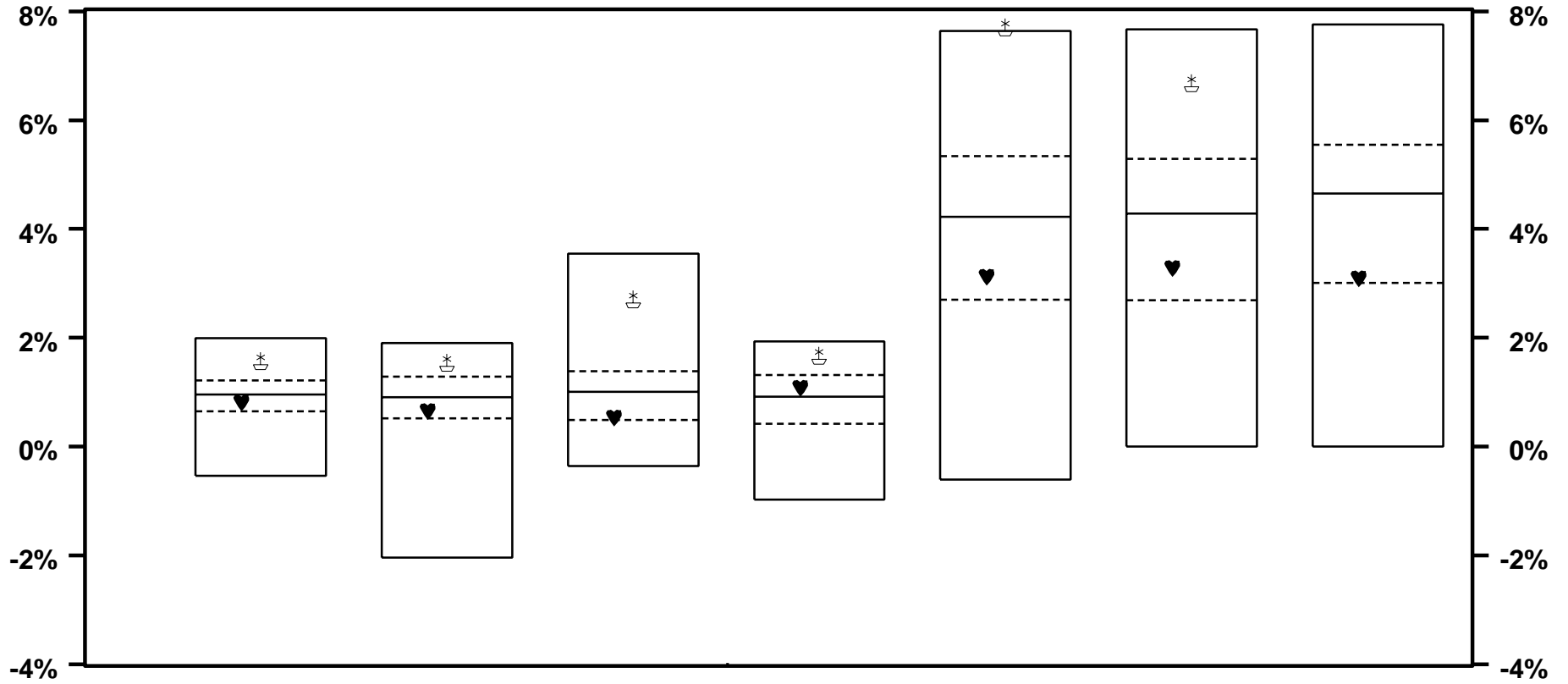

	<u>THIS</u> <u>QUARTER</u>	<u>LAST</u> <u>QUARTER</u>	<u>2 QTRS</u> <u>AGO</u>	<u>3 QTRS</u> <u>AGO</u>	<u>LAST</u> <u>YEAR</u>	<u>LAST</u> <u>2 YEARS</u>	<u>LAST</u> <u>3 YEARS</u>
♥ SEIX CORE	0.8 66	0.7 62	0.5 74	1.1 40	3.1 66	3.3 65	3.1 74
‡ SEIX HIGH YIELD	1.6 11	1.5 12	2.7 7	1.7 10	7.7 4	6.7 7	
MEDIAN	1.0	0.9	1.0	0.9	4.2	4.3	4.7

VERMONT MUNICIPAL EMPLOYEES

BOND FUNDS - TOTAL RETURN VS RISK

3 YEARS ENDING 6/05

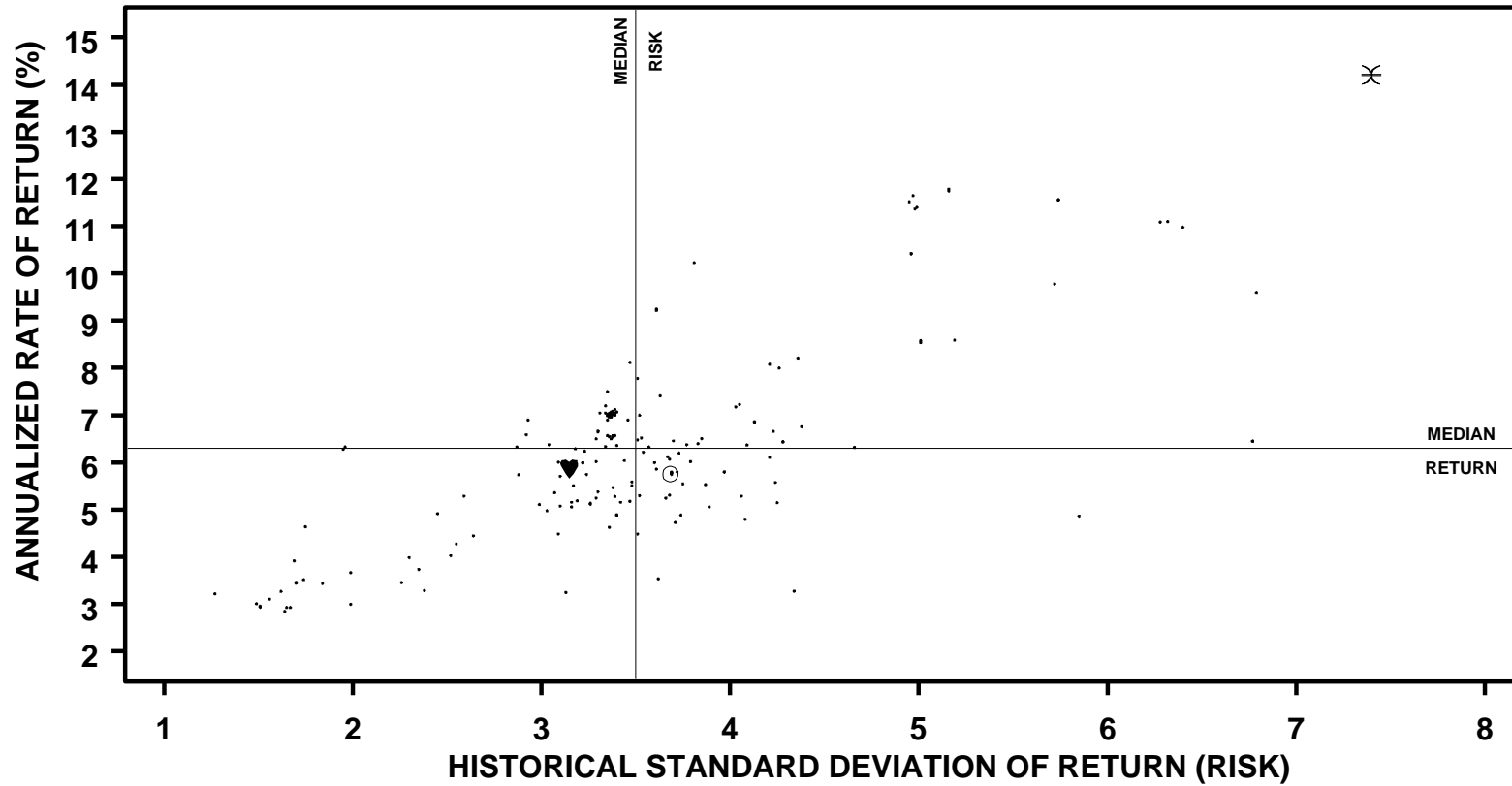

	ANNUALIZED RETURN		STANDARD DEVIATION		SHARPE RATIO	
	VALUE	RANK	VALUE	RANK	VALUE	RANK
♥ SEIX CORE	5.9	60	3.1	75	1.3	47
○ LB AGGREGATE	5.8	64	3.7	37	1.1	65
⌘ ML HIGH YLD II	14.2	1	7.4	5	1.7	15
MEDIAN	6.3		3.5		1.3	

VERMONT MUNICIPAL EMPLOYEES

BOND FUNDS - TOTAL RETURN VS RISK

5 YEARS ENDING 6/05

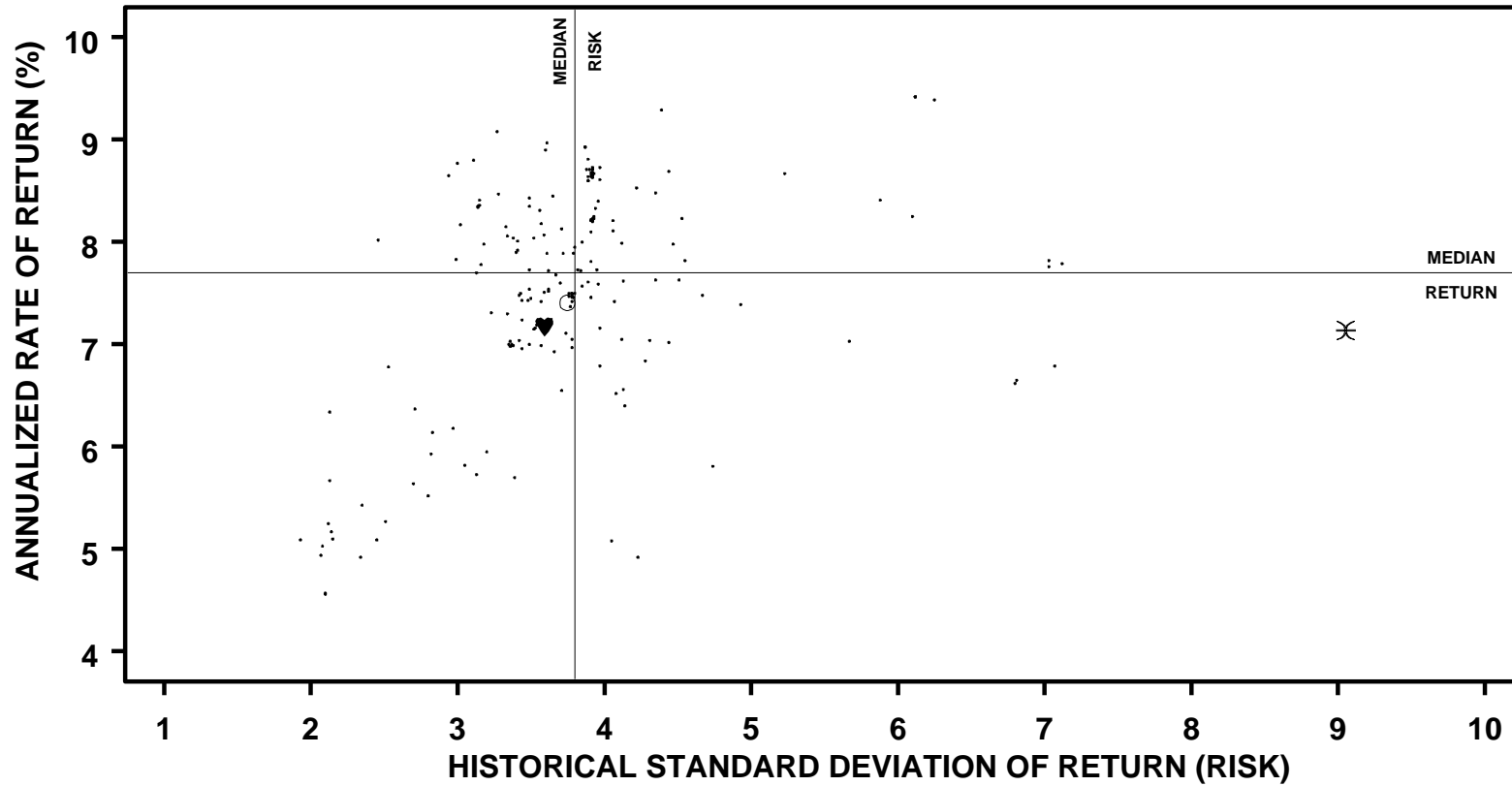

	ANNUALIZED RETURN		STANDARD DEVIATION		SHARPE RATIO	
	VALUE	RANK	VALUE	RANK	VALUE	RANK
♥ SEIX CORE	7.2	66	3.6	60	1.2	56
○ LB AGGREGATE	7.4	60	3.8	50	1.2	54
⌘ ML HIGH YLD II	7.1	67	9.1	1	0.5	96
MEDIAN	7.7		3.8		1.3	

VERMONT MUNICIPAL EMPLOYEES

BOND ONLY - RATES OF RETURN

PERIODS ENDING 6/05

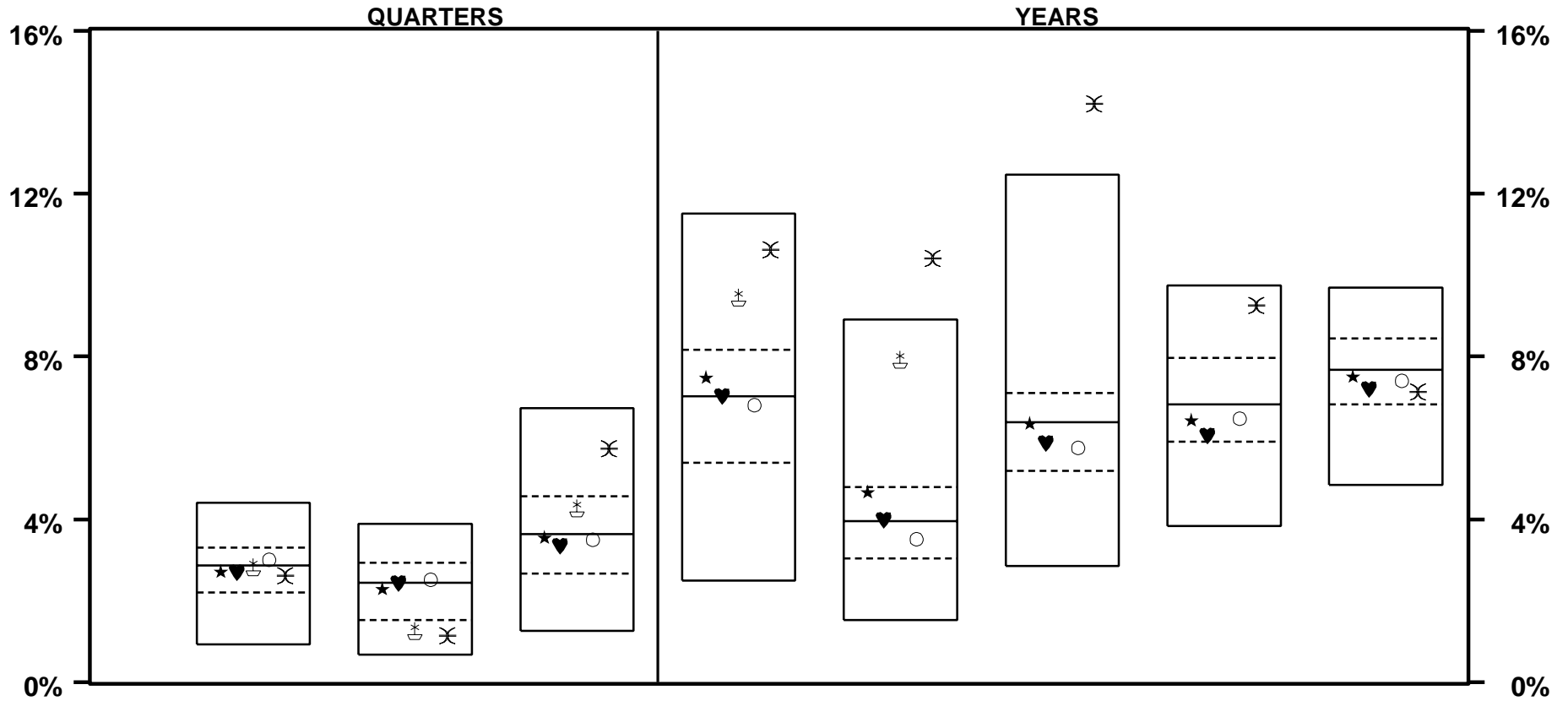

	LAST QTR		LAST 2 QTRS		LAST 3 QTRS		LAST YEAR		LAST 2 YEARS		LAST 3 YEARS		LAST 4 YEARS		LAST 5 YEARS	
★ MUNI COMPOSITE	2.7	55	2.3	54	3.5	53	7.5	40	4.7	34	6.4	50	6.4	62	7.5	54
♥ SEIX CORE	2.7	55	2.4	49	3.4	60	7.0	49	4.0	49	5.9	60	6.1	71	7.2	64
♣ SEIX HIGH YIELD	2.8	50	1.3	81	4.3	30	9.5	11	7.9	8						
○ LB AGGREGATE	3.0	41	2.5	45	3.5	55	6.8	56	3.5	62	5.8	64	6.5	61	7.4	59
✕ ML HIGH YLD II	2.6	59	1.1	84	5.7	7	10.6	6	10.4	2	14.2	2	9.3	6	7.1	67
MEDIAN	2.9		2.4		3.6		7.0		4.0		6.4		6.8		7.7	

VERMONT MUNICIPAL EMPLOYEES

BOND ONLY - RATES OF RETURN

PERIODS ENDING 6/05

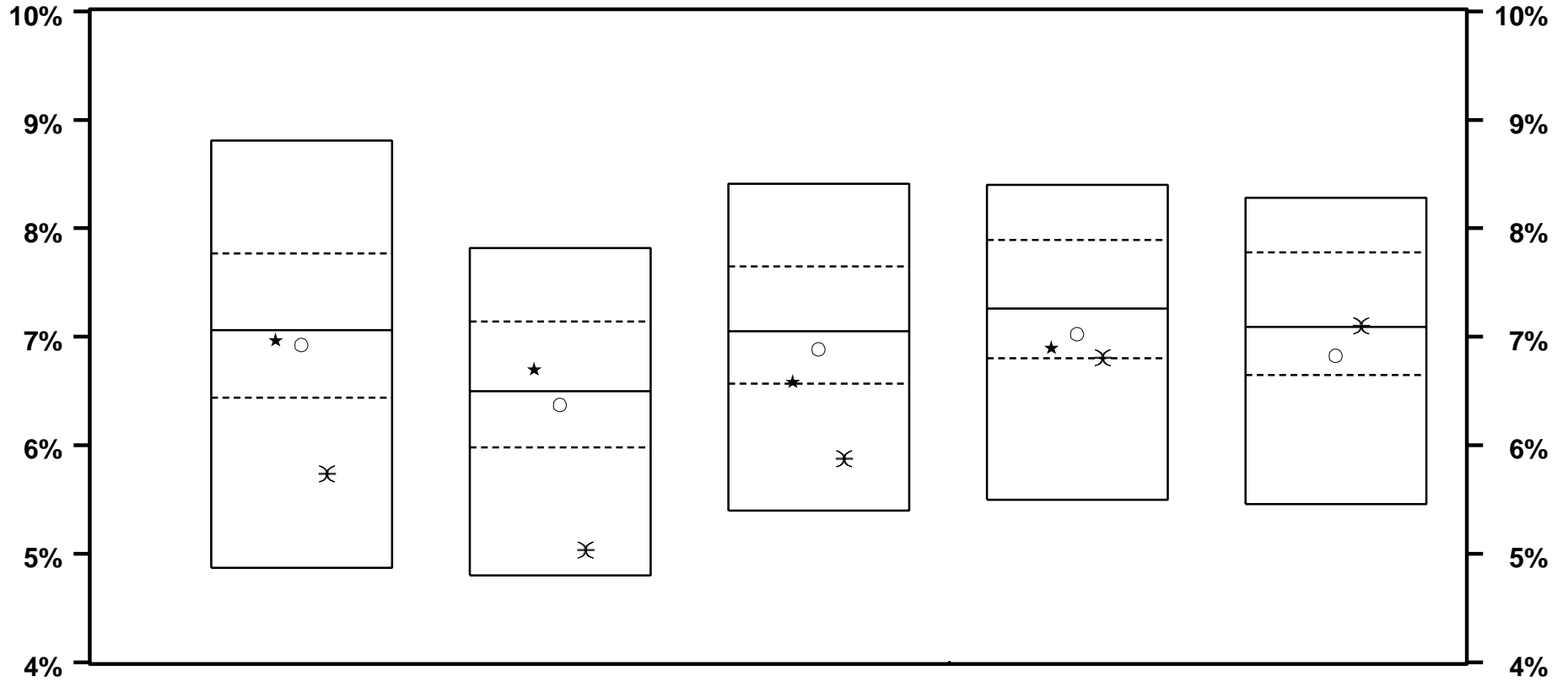

	LAST 6 YEARS		LAST 7 YEARS		LAST 8 YEARS		LAST 9 YEARS		LAST 10 YEARS	
★ MUNI COMPOSITE	7.0	54	6.7	39	6.6	74	6.9	71		
○ LB AGGREGATE	6.9	56	6.4	56	6.9	59	7.0	63	6.8	64
✕ ML HIGH YLD II	5.7	86	5.0	92	5.9	89	6.8	74	7.1	49
MEDIAN	7.1		6.5		7.0		7.3		7.1	

VERMONT MUNICIPAL EMPLOYEES

BOND ONLY - RATES OF RETURN

YEARS ENDING

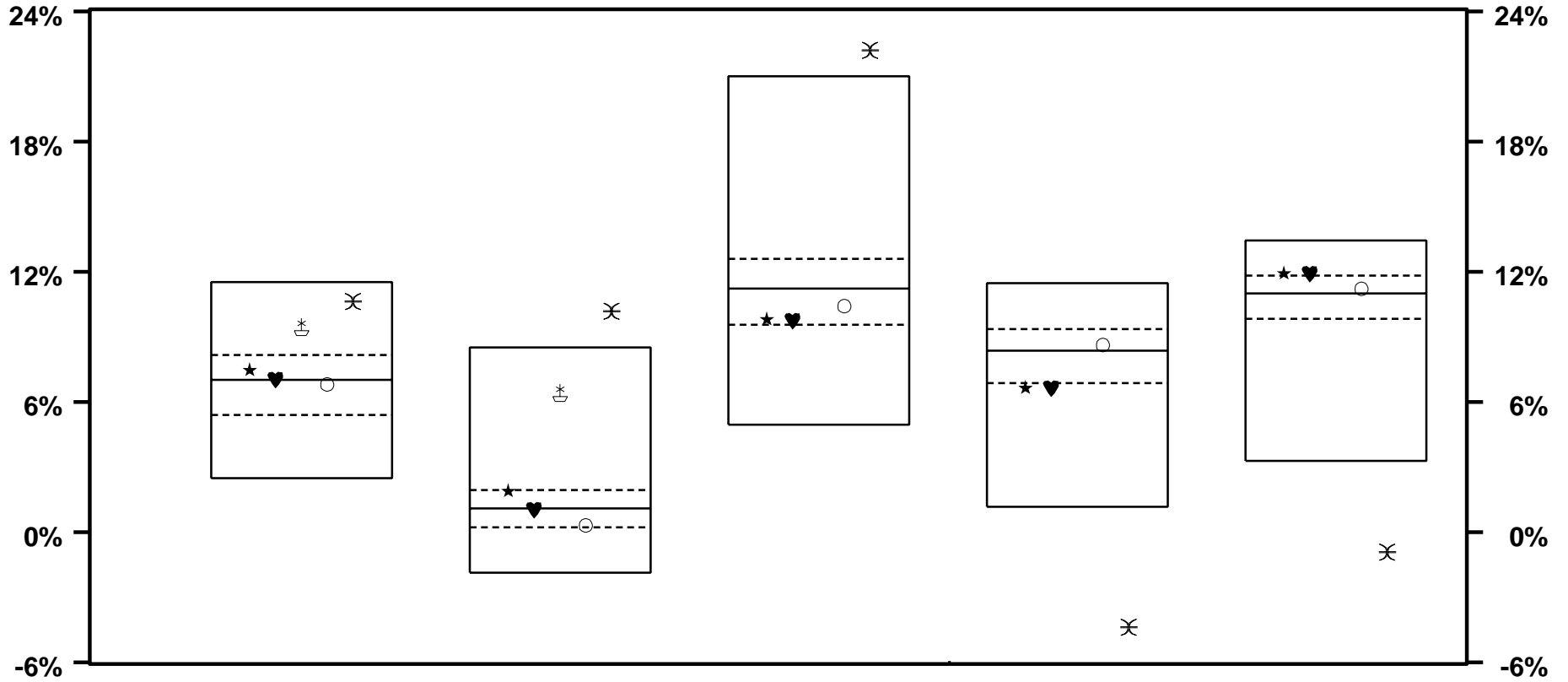

	6 / 05		6 / 04		6 / 03		6 / 02		6 / 01	
★ MUNI COMPOSITE	7.5	40	1.9	25	9.8	72	6.7	76	11.9	22
♥ SEIX CORE	7.0	49	1.0	50	9.8	72	6.6	77	11.9	23
⊠ SEIX HIGH YIELD	9.5	11	6.4	9						
○ LB AGGREGATE	6.8	56	0.3	70	10.4	64	8.6	42	11.2	43
⌘ ML HIGH YLD II	10.6	6	10.2	2	22.2	4	-4.4	98	-0.9	98
MEDIAN	7.0		1.1		11.2		8.4		11.0	

VERMONT MUNICIPAL EMPLOYEES

BOND ONLY - RATES OF RETURN

YEARS ENDING

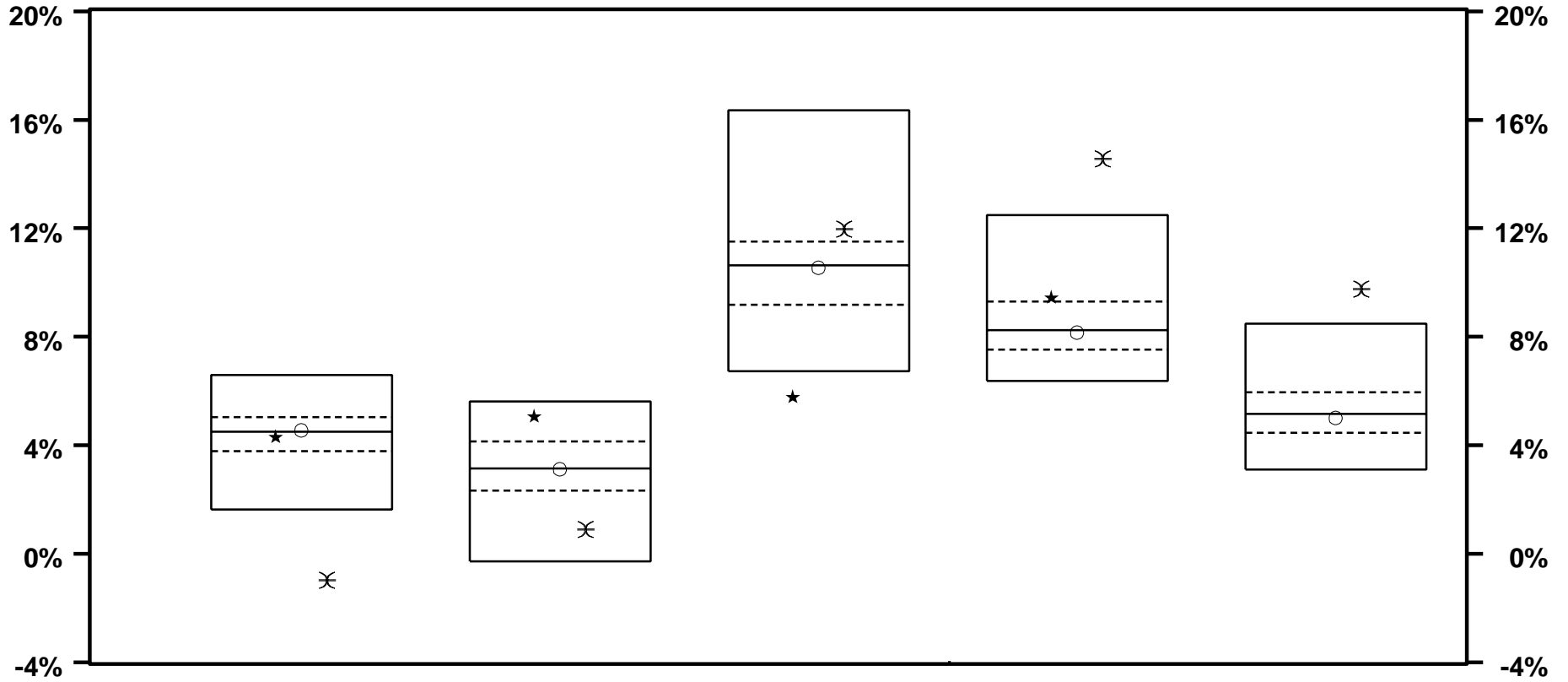

	6 / 00		6 / 99		6 / 98		6 / 97		6 / 96	
★ MUNI COMPOSITE	4.3	58	5.1	9	5.8	97	9.5	22		
○ LB AGGREGATE	4.6	47	3.1	50	10.5	52	8.2	52	5.0	54
✕ ML HIGH YLD II	-1.0	98	0.9	91	12.0	16	14.6	3	9.8	3
MEDIAN	4.5		3.1		10.6		8.2		5.2	

VERMONT MUNICIPAL EMPLOYEES

BOND ONLY RETURNS VS RISK
3 YEARS ENDING 6/05

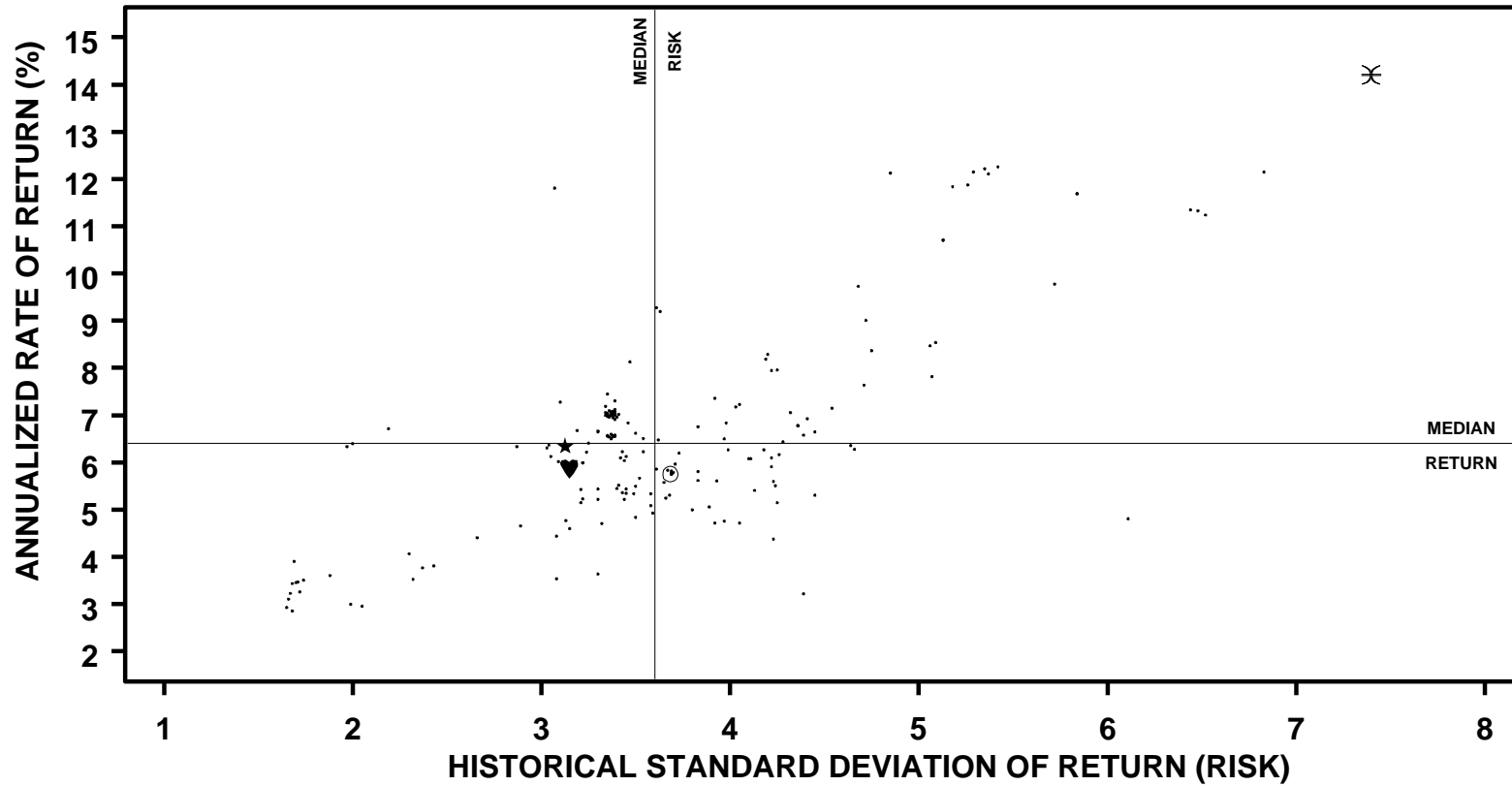

	ANNUALIZED RETURN		STANDARD DEVIATION		SHARPE RATIO	
	VALUE	RANK	VALUE	RANK	VALUE	RANK
★ MUNI COMPOSITE	6.4	50	3.1	80	1.5	29
♥ SEIX CORE	5.9	60	3.2	79	1.4	41
○ LB AGGREGATE	5.8	64	3.7	45	1.1	60
⌘ ML HIGH YLD II	14.2	2	7.4	6	1.7	13
MEDIAN	6.4		3.6		1.2	

VERMONT MUNICIPAL EMPLOYEES

BOND ONLY RETURNS VS RISK

5 YEARS ENDING 6/05

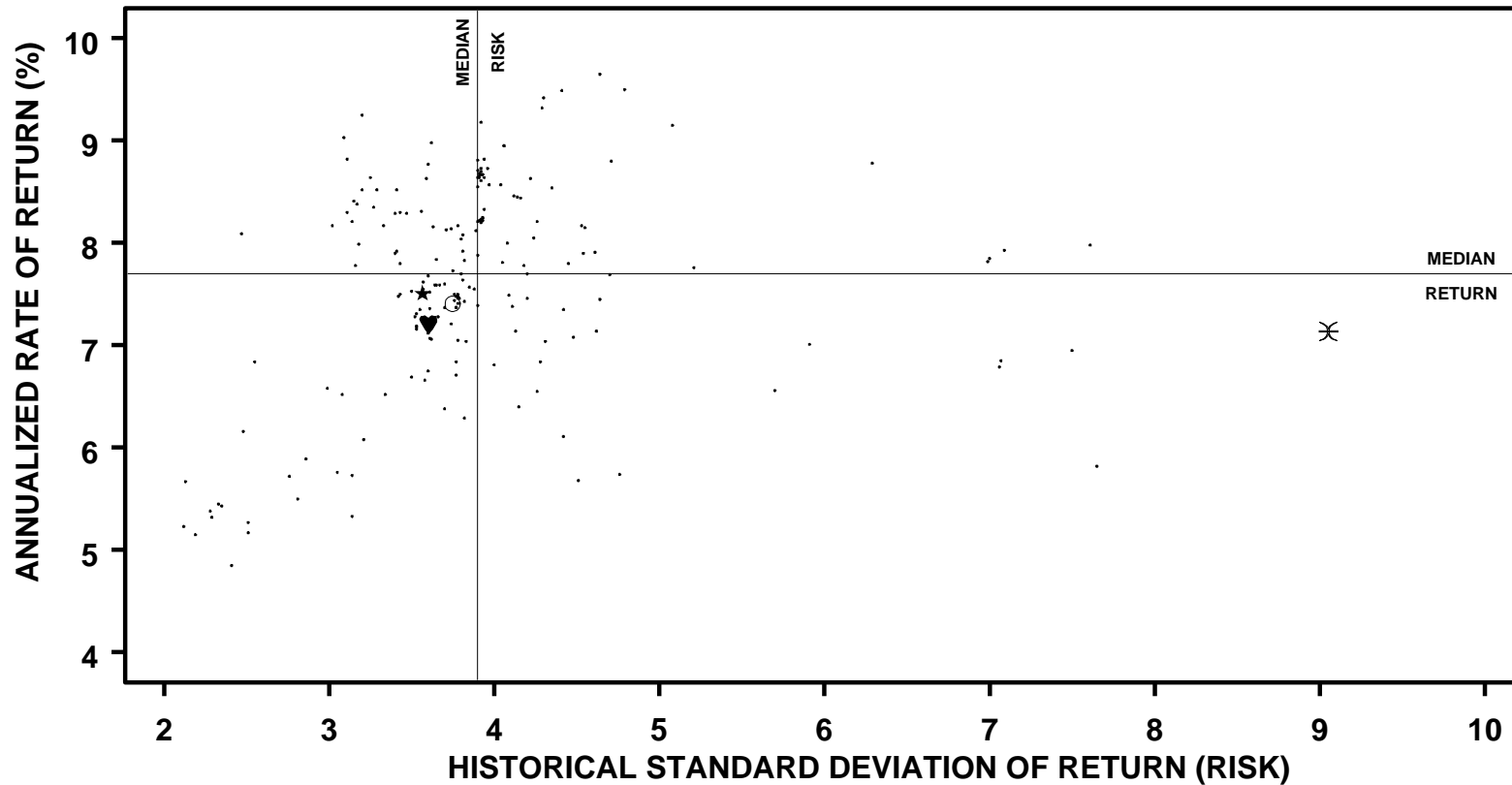

	ANNUALIZED RETURN		STANDARD DEVIATION		SHARPE RATIO	
	VALUE	RANK	VALUE	RANK	VALUE	RANK
★ MUNI COMPOSITE	7.5	54	3.6	69	1.3	37
♥ SEIX CORE	7.2	64	3.6	66	1.2	49
○ LB AGGREGATE	7.4	59	3.8	59	1.2	48
⌘ ML HIGH YLD II	7.1	67	9.1	2	0.5	95
MEDIAN	7.7		3.9		1.2	

VERMONT MUNICIPAL EMPLOYEES

CASH FUNDS - TOTAL RATES OF RETURN

PERIODS ENDING 6/05

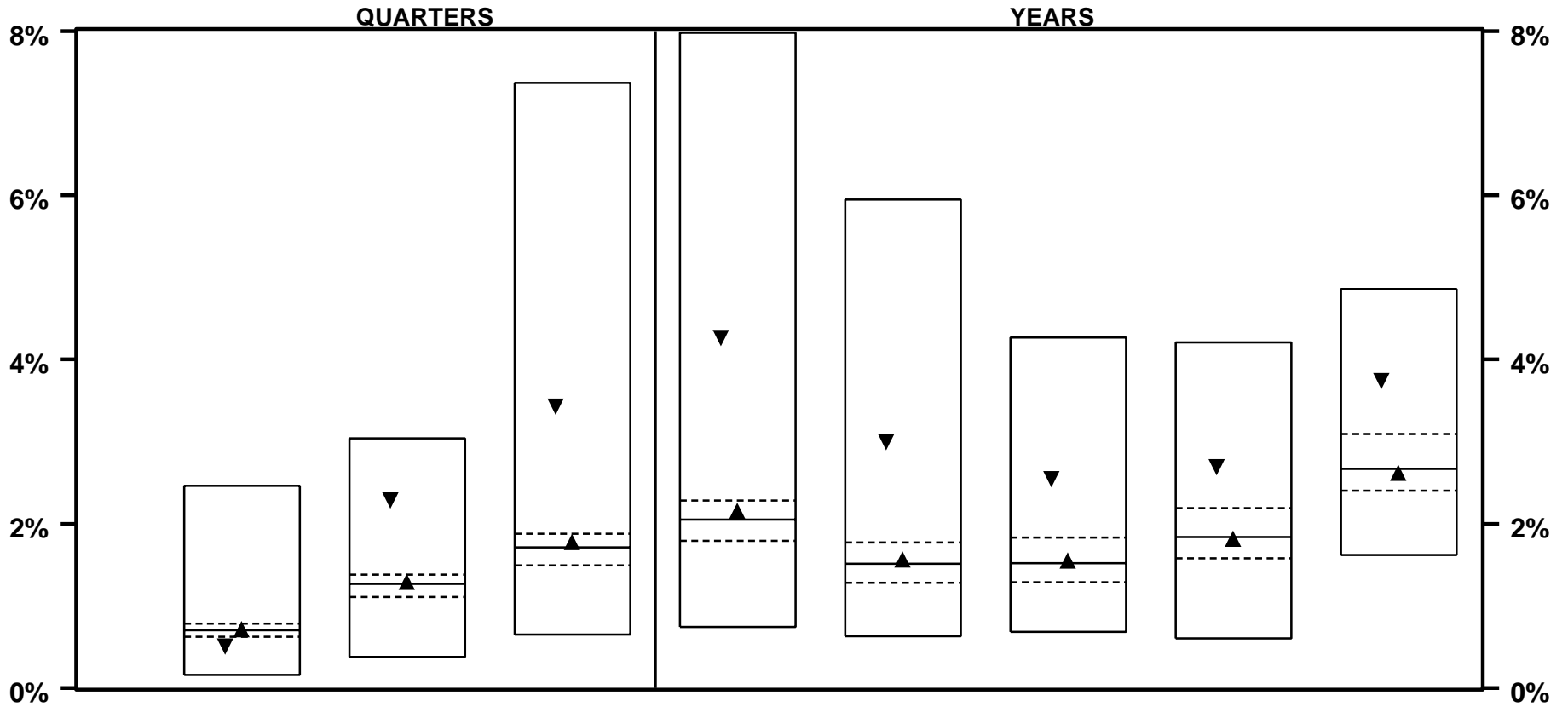

	LAST QTR		LAST 2 QTRS		LAST 3 QTRS		LAST YEAR		LAST 2 YEARS		LAST 3 YEARS		LAST 4 YEARS		LAST 5 YEARS	
▼ VERMONT INVEST	0.5	86	2.3	7	3.4	9	4.3	9	3.0	9	2.5	12	2.7	14	3.7	13
▲ 90 DAY T-BILLS	0.7	40	1.3	41	1.8	36	2.2	36	1.6	42	1.6	44	1.8	52	2.6	55
MEDIAN	0.7		1.3		1.7		2.0		1.5		1.5		1.8		2.7	

VERMONT MUNICIPAL EMPLOYEES

CASH FUNDS - TOTAL RATES OF RETURN

PERIODS ENDING 6/05

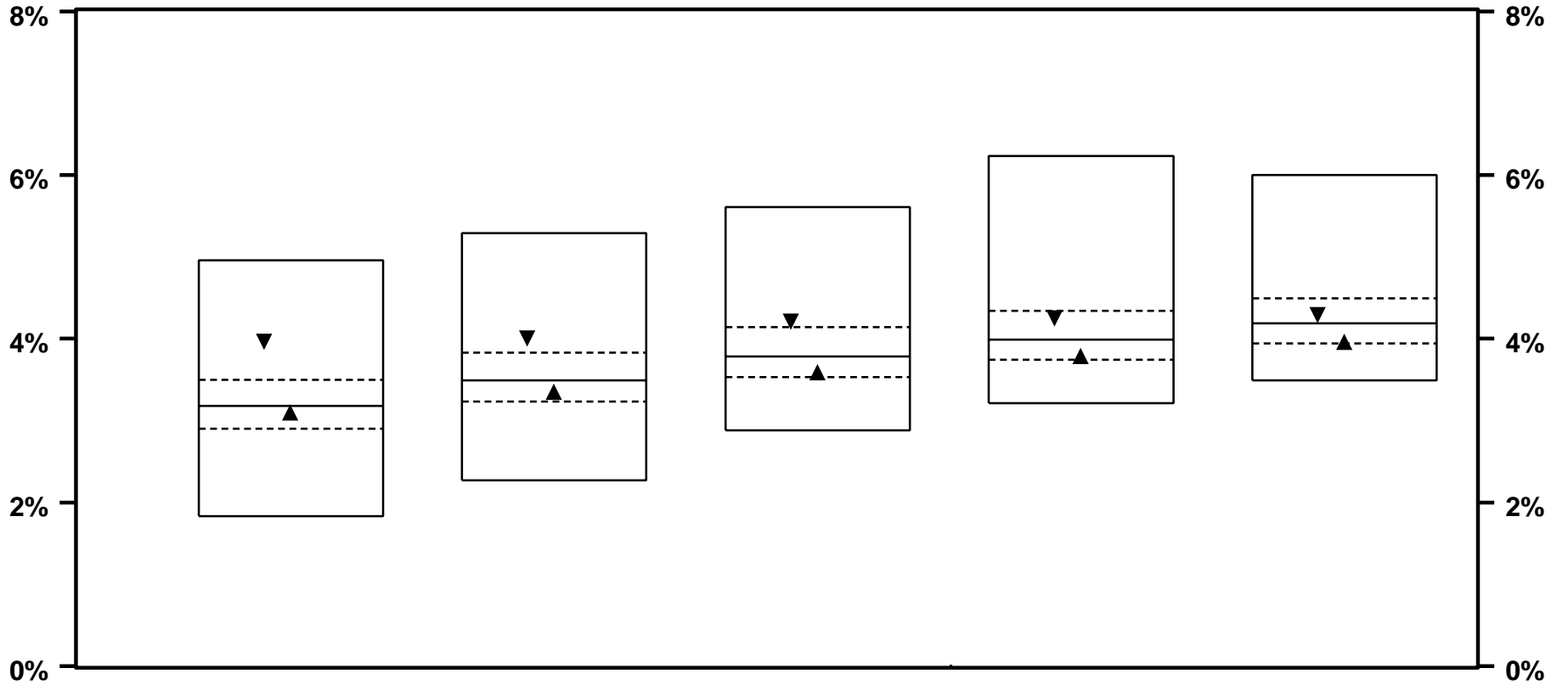

	LAST 6 YEARS	LAST 7 YEARS	LAST 8 YEARS	LAST 9 YEARS	LAST 10 YEARS
▼ VERMONT INVEST	4.0 14	4.0 20	4.2 22	4.3 29	4.3 39
▲ 90 DAY T-BILLS	3.1 59	3.4 63	3.6 68	3.8 69	4.0 71
MEDIAN	3.2	3.5	3.8	4.0	4.2

VERMONT MUNICIPAL EMPLOYEES

CASH FUNDS - TOTAL RATES OF RETURN

YEARS ENDING

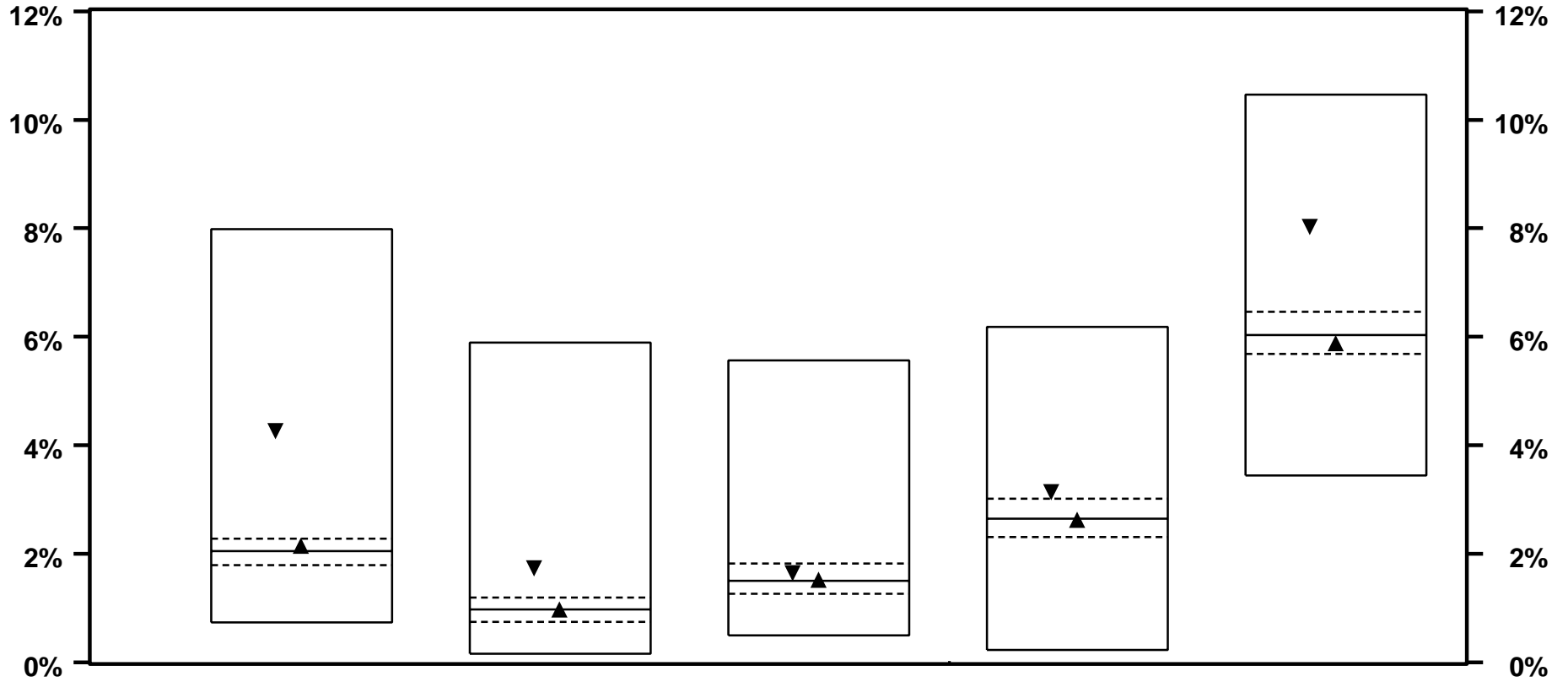

	6 / 05	6 / 04	6 / 03	6 / 02	6 / 01
▼ VERMONT INVEST	4.3 9	1.7 13	1.6 33	3.1 21	8.0 11
▲ 90 DAY T-BILLS	2.2 36	1.0 46	1.5 45	2.6 51	5.9 61
MEDIAN	2.0	1.0	1.5	2.6	6.0

VERMONT MUNICIPAL EMPLOYEES

CASH FUNDS - TOTAL RATES OF RETURN

YEARS ENDING

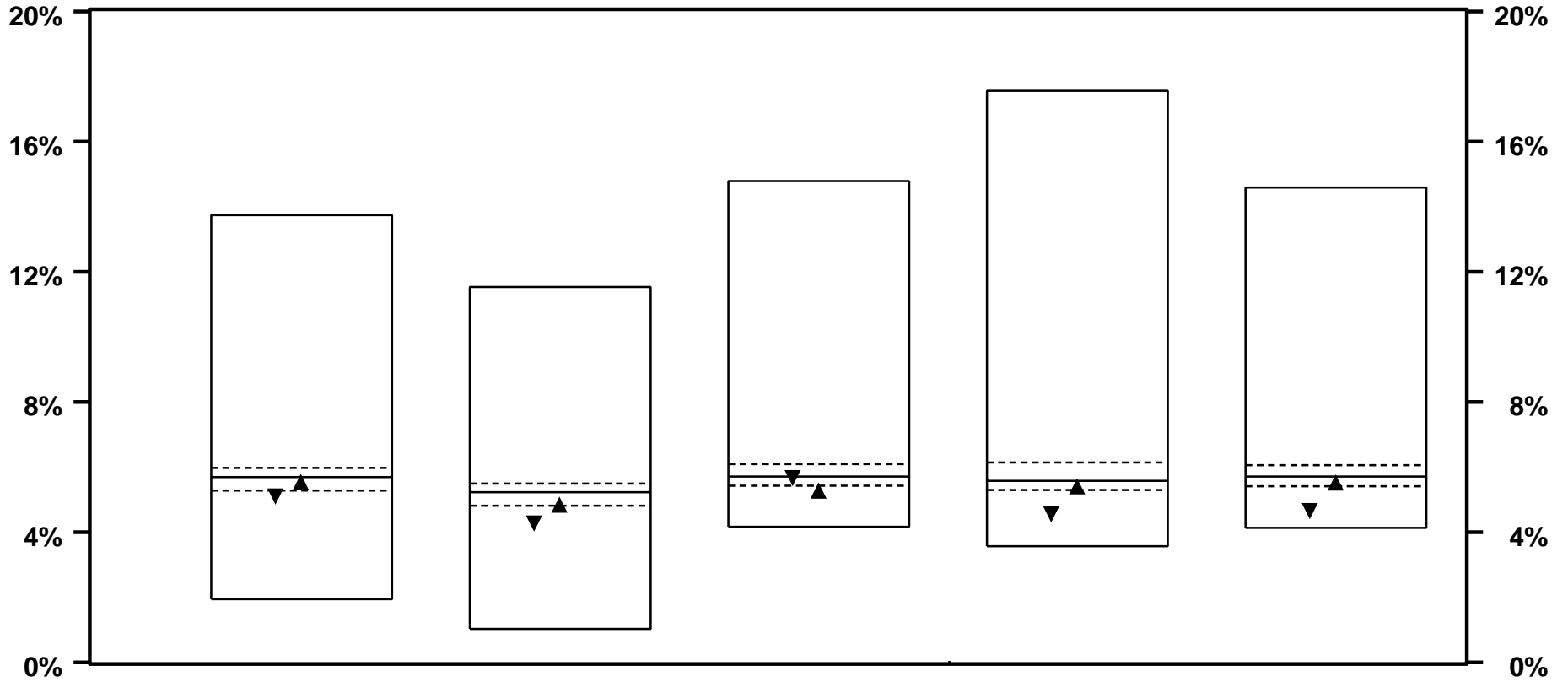

	6 / 00	6 / 99	6 / 98	6 / 97	6 / 96
▼ VERMONT INVEST	5.1 81	4.3 86	5.7 56	4.6 91	4.7 91
▲ 90 DAY T-BILLS	5.6 60	4.9 72	5.3 83	5.4 65	5.5 66
MEDIAN	5.7	5.2	5.7	5.6	5.7

VERMONT MUNICIPAL EMPLOYEES

CASH EQUIVALENTS - RATES OF RETURN

PERIODS ENDING 6/05

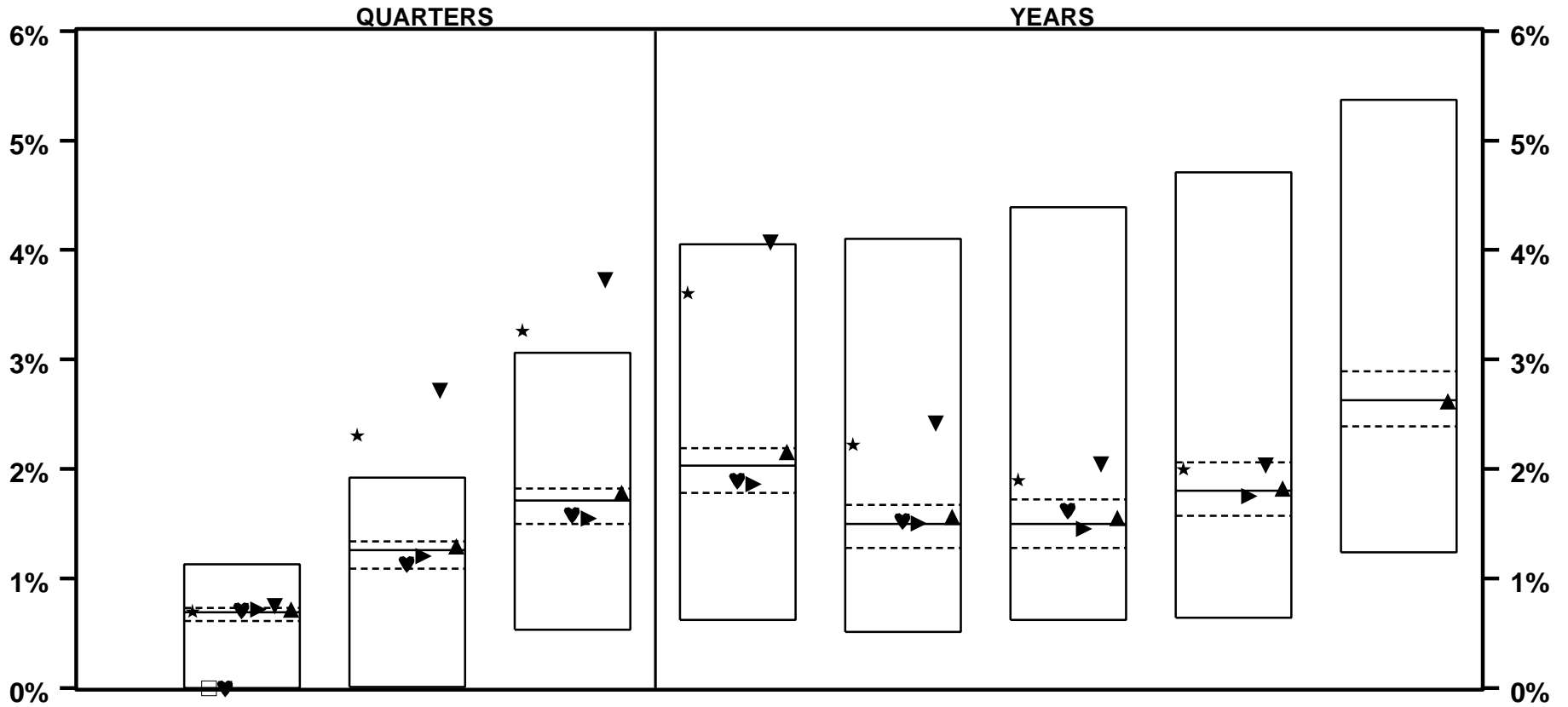

	LAST QTR		LAST 2 QTRS		LAST 3 QTRS		LAST YEAR		LAST 2 YEARS		LAST 3 YEARS		LAST 4 YEARS		LAST 5 YEARS	
★ MUNI COMPOSITE	0.7	42	2.3	3	3.3	4	3.6	5	2.2	10	1.9	17	2.0	28		
□ EQTY COMPOSITE	0.0	95														
♥ DELAWARE	0.0	95														
♥ UBS	0.7	35	1.1	70	1.6	64	1.9	64	1.5	44	1.6	30				
▶ ALT. ASSETS	0.7	29	1.2	58	1.6	69	1.9	67	1.5	48	1.5	58	1.8	57		
▼ VERMONT INVEST	0.8	18	2.7	3	3.7	3	4.1	4	2.4	8	2.0	14	2.0	26		
▲ 90 DAY T-BILLS	0.7	29	1.3	35	1.8	31	2.2	28	1.6	36	1.6	38	1.8	45	2.6	51
MEDIAN	0.7		1.3		1.7		2.0		1.5		1.5		1.8		2.6	

VERMONT MUNICIPAL EMPLOYEES

CASH EQUIVALENTS - RATES OF RETURN

YEARS ENDING

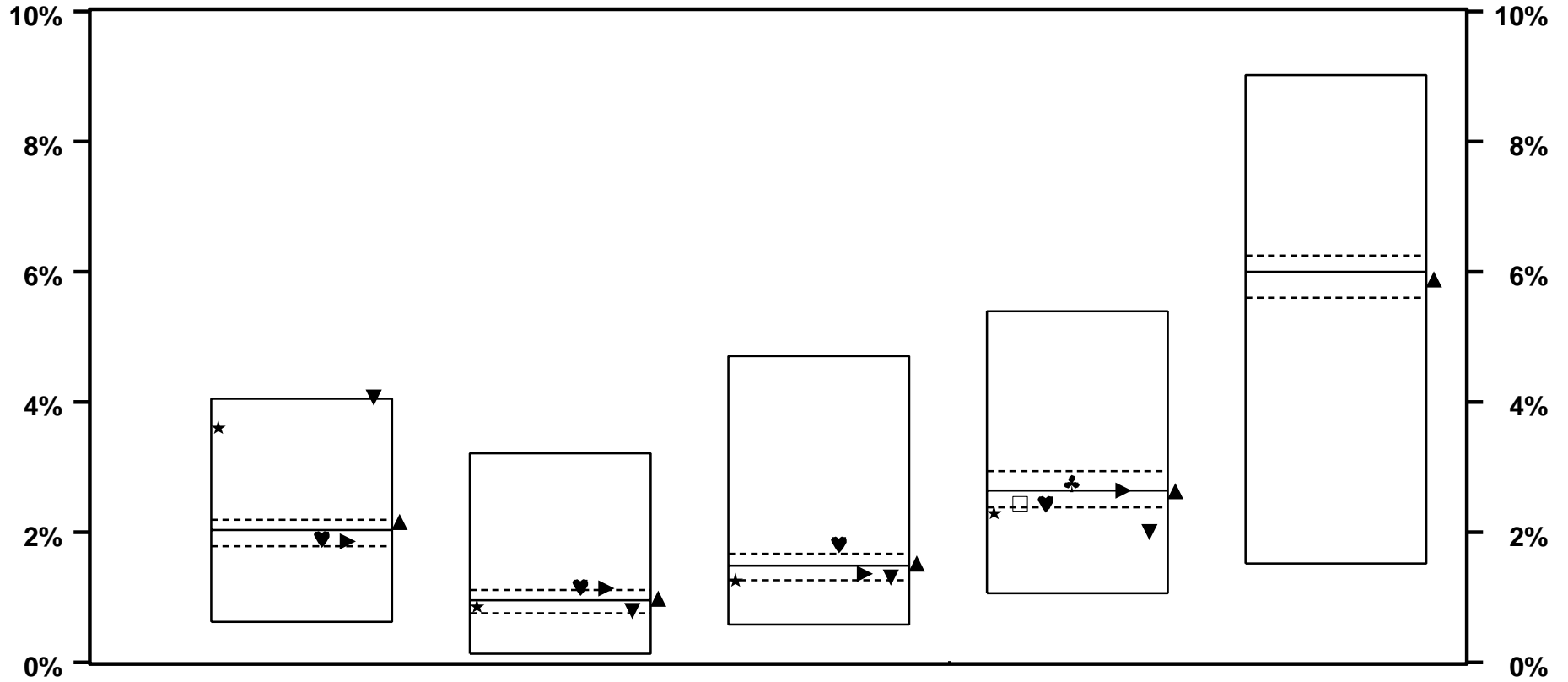

	6 / 05		6 / 04		6 / 03		6 / 02		6 / 01	
★ MUNI COMPOSITE	3.6	5	0.9	65	1.3	75	2.3	80		
□ EQTY COMPOSITE							2.4	71		
♥ DELAWARE							2.4	71		
♣ ALLIANCE							2.8	35		
♥ UBS	1.9	64	1.2	21	1.8	18				
▶ ALT. ASSETS	1.9	67	1.1	22	1.4	67	2.6	49		
▼ VERMONT INVEST	4.1	4	0.8	71	1.3	72	2.0	89		
▲ 90 DAY T-BILLS	2.2	28	1.0	42	1.5	40	2.6	50	5.9	58
MEDIAN	2.0		1.0		1.5		2.6		6.0	

VERMONT MUNICIPAL EMPLOYEES

INT'L DEVELOPED MKT EQUITY FUNDS - RATES OF RETURN

PERIODS ENDING 6/05

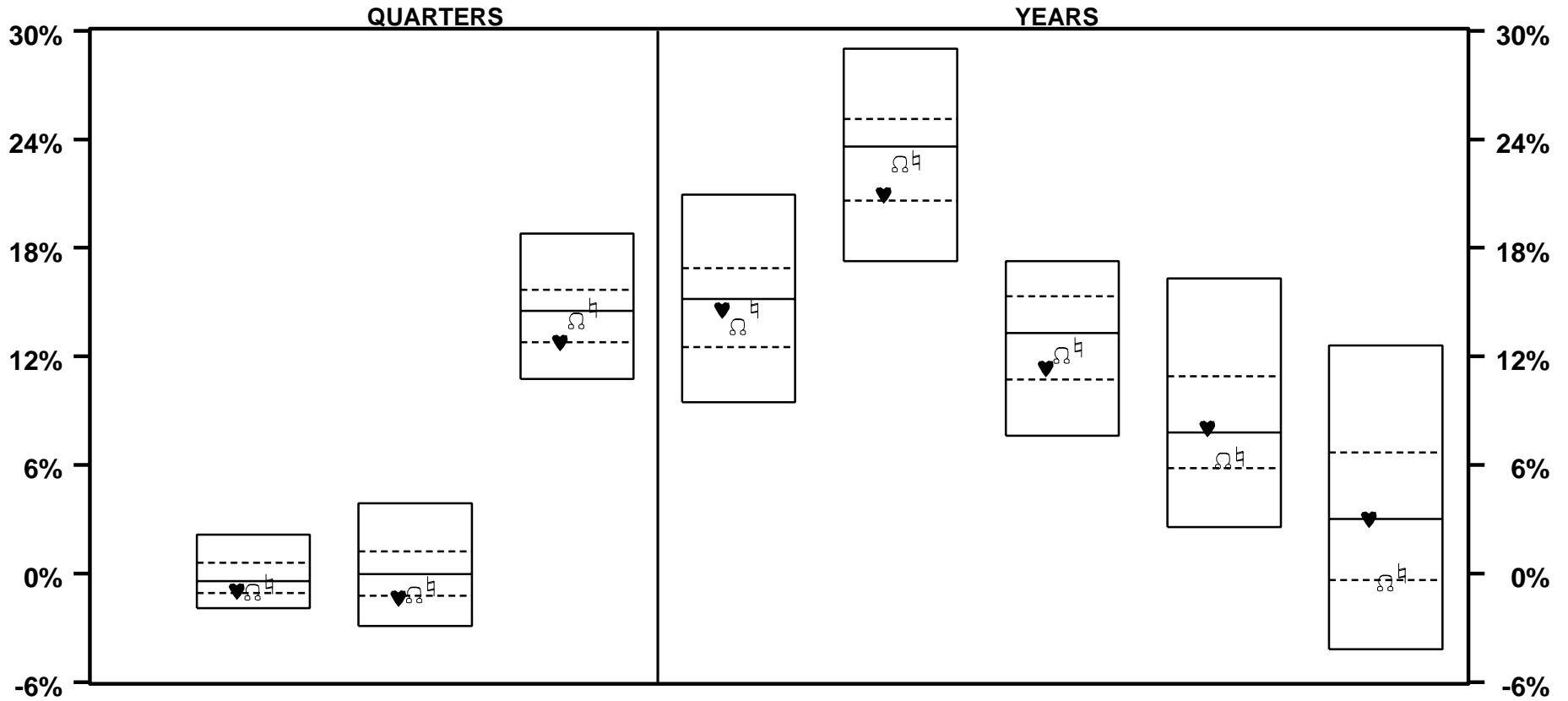

	LAST QTR		LAST 2 QTRS		LAST 3 QTRS		LAST YEAR		LAST 2 YEARS		LAST 3 YEARS		LAST 4 YEARS		LAST 5 YEARS	
♥ UBS	-1.0	70	-1.3	77	12.8	74	14.6	54	20.9	73	11.3	69	8.0	47	3.0	49
⊙ MS EAFE NET	-1.0	72	-1.2	73	14.0	59	13.7	60	22.7	59	12.1	62	6.2	70	-0.5	76
⊠ CITI PMI EPAC	-0.6	58	-0.7	61	14.7	46	14.7	54	22.9	56	12.5	59	6.5	68	0.0	72
MEDIAN	-0.4		0.0		14.5		15.2		23.6		13.3		7.8		3.0	

VERMONT MUNICIPAL EMPLOYEES

INT'L DEVELOPED MKT EQUITY FUNDS - RATES OF RETURN

PERIODS ENDING 6/05

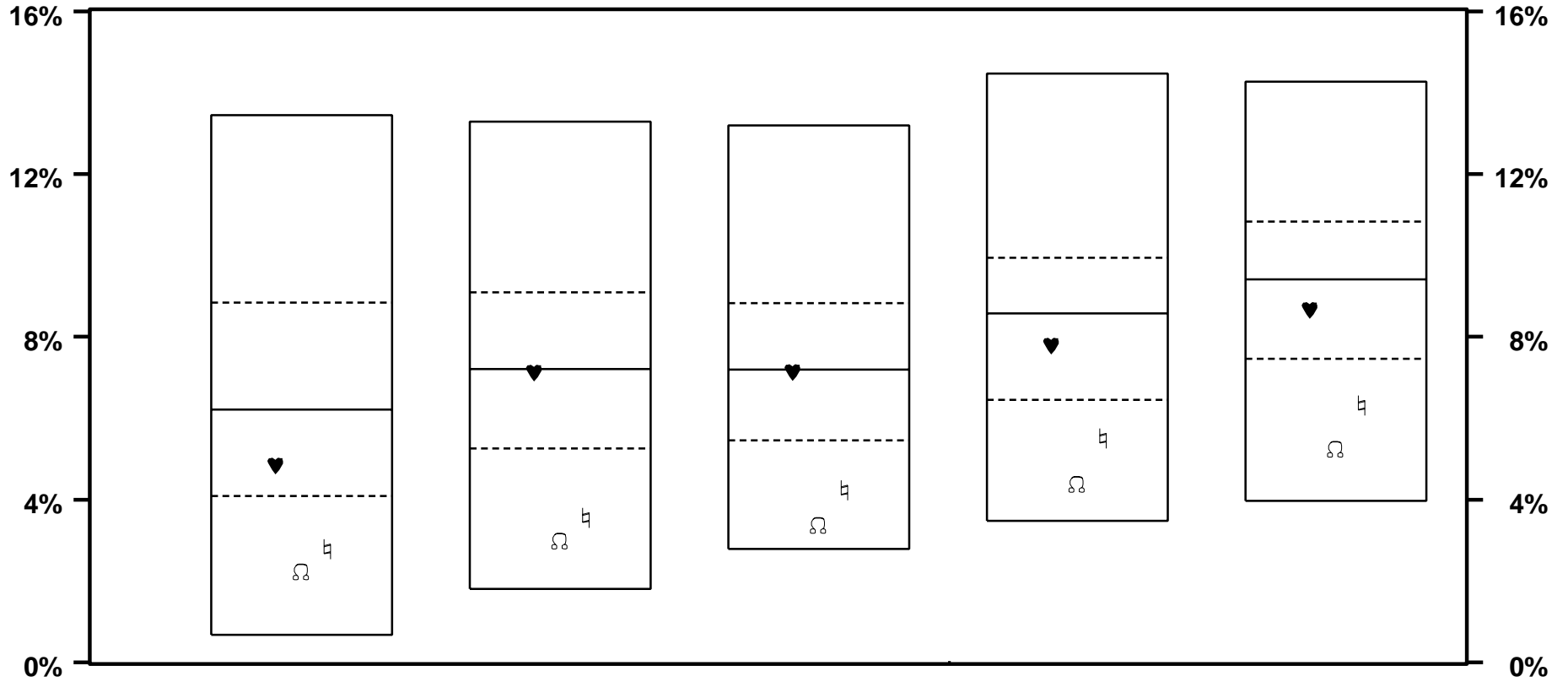

	LAST 6 YEARS	LAST 7 YEARS	LAST 8 YEARS	LAST 9 YEARS	LAST 10 YEARS
♥ UBS	4.8 66	7.1 50	7.1 50	7.8 66	8.7 64
⊙ MS EAFE NET	2.2 89	3.0 88	3.4 91	4.4 93	5.2 92
⊠ CITI PMI EPAC	2.8 83	3.6 82	4.2 82	5.5 83	6.3 82
MEDIAN	6.2	7.2	7.2	8.6	9.4

VERMONT MUNICIPAL EMPLOYEES

INT'L DEVELOPED MKT EQUITY FUNDS - RATES OF RETURN

YEARS ENDING

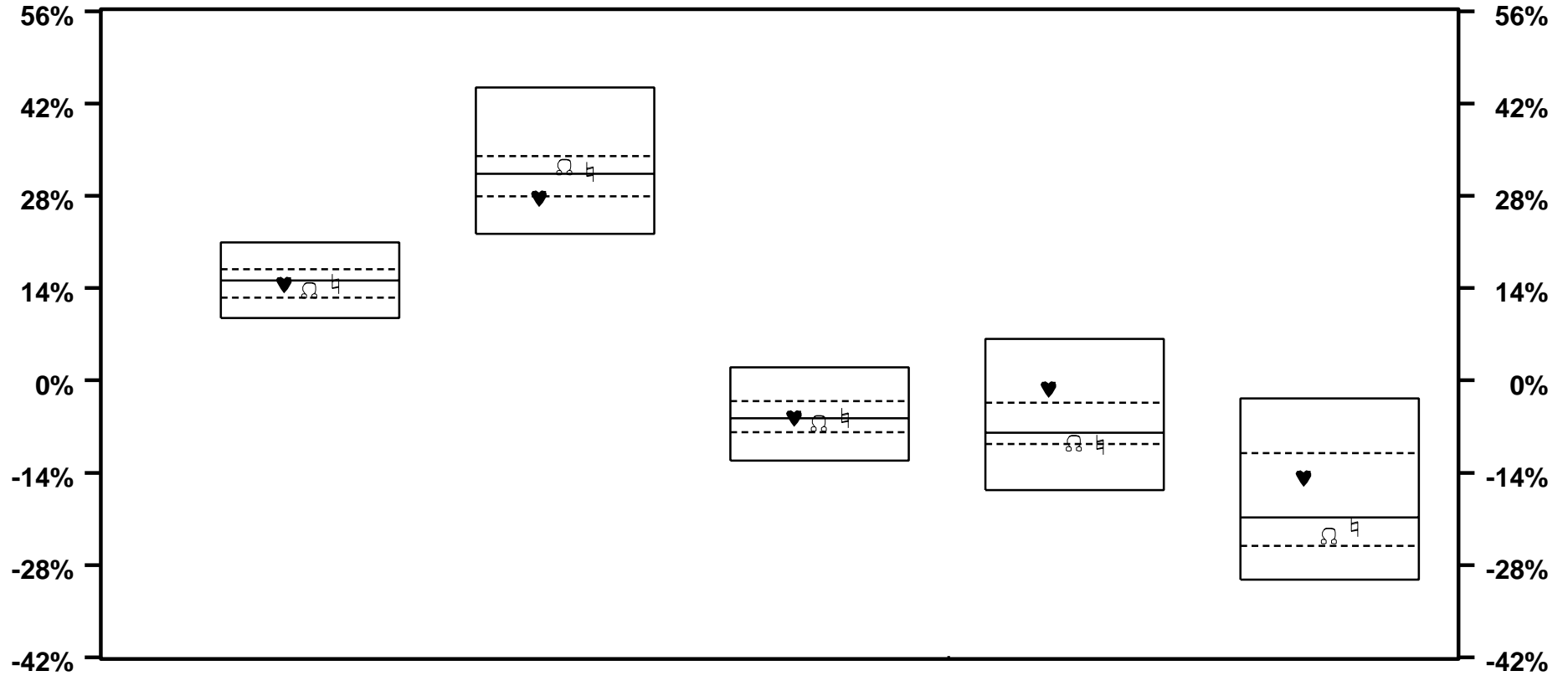

	6 / 05		6 / 04		6 / 03		6 / 02		6 / 01	
♥ UBS	14.6	54	27.7	76	-5.6	49	-1.3	19	-14.8	32
Ω MS EAFE NET	13.7	60	32.4	33	-6.5	57	-9.5	73	-23.5	69
□ CITI PMI EPAC	14.7	54	31.6	48	-5.6	49	-9.7	75	-22.2	61
MEDIAN	15.2		31.3		-5.7		-8.0		-20.8	

VERMONT MUNICIPAL EMPLOYEES

INT'L DEVELOPED MKT EQUITY FUNDS - RATES OF RETURN

YEARS ENDING

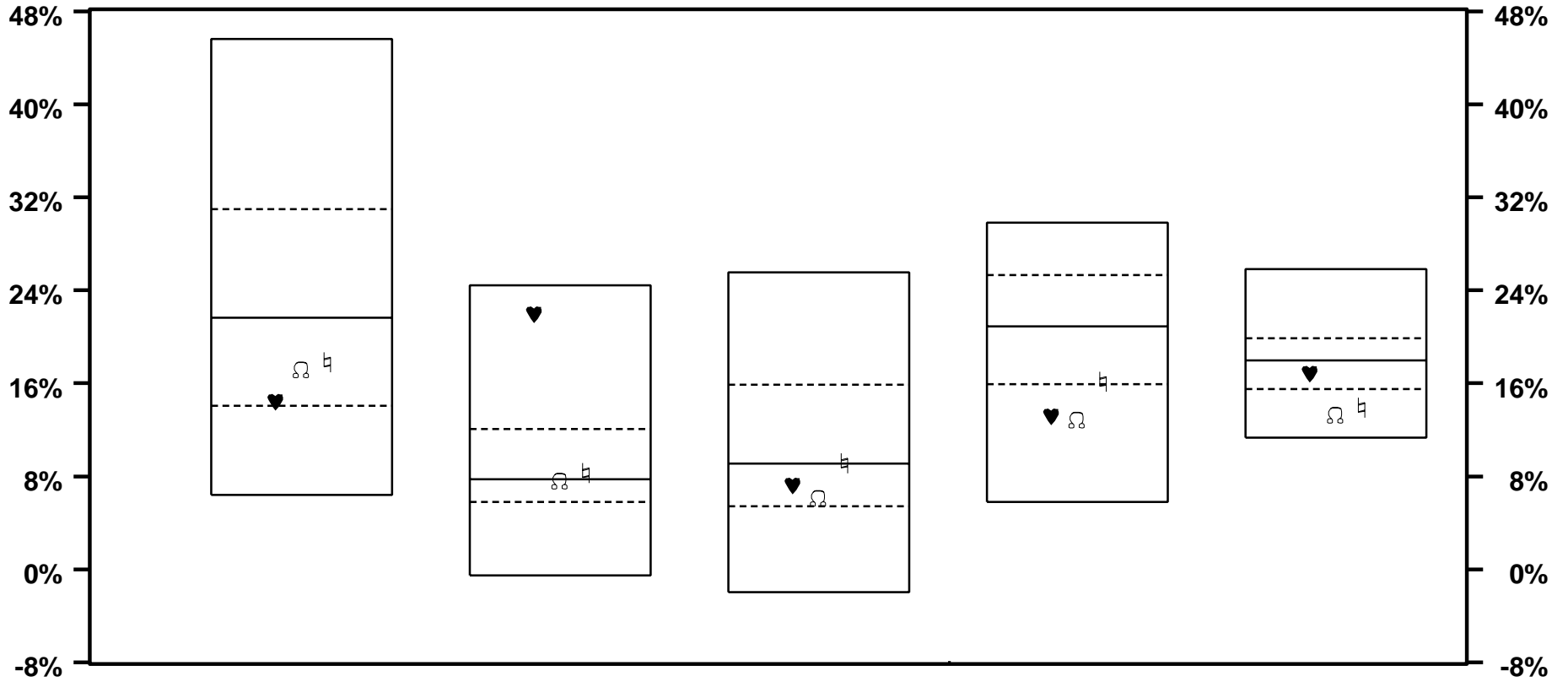

	6 / 00		6 / 99		6 / 98		6 / 97		6 / 96	
♥ UBS	14.4	74	21.9	6	7.2	62	13.2	84	16.8	66
Ω MS EAFE NET	17.2	62	7.6	53	6.1	68	12.8	85	13.3	89
□ CITI PMI EPAC	17.8	58	8.3	40	9.1	49	16.2	74	14.0	83
MEDIAN	21.6		7.8		9.1		20.9		17.9	

VERMONT MUNICIPAL EMPLOYEES

INT'L DEVELOPED MKT EQUITY FUNDS - TOTAL RETURN VS RISK

3 YEARS ENDING 6/05

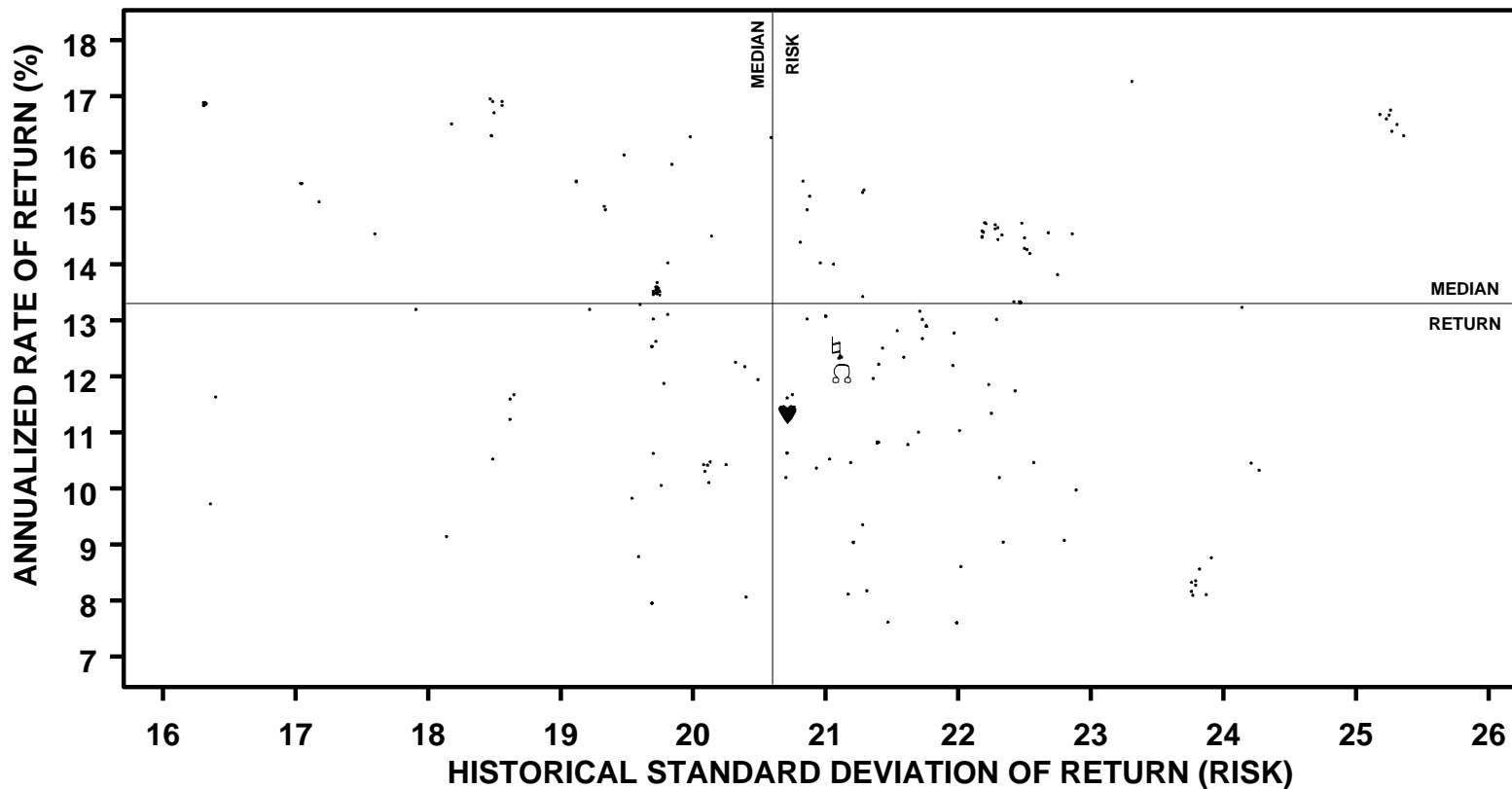

	ANNUALIZED RETURN		STANDARD DEVIATION		SHARPE RATIO	
	VALUE	RANK	VALUE	RANK	VALUE	RANK
♥ UBS	11.3	69	20.7	47	0.6	70
Ω MS EAFE NET	12.1	62	21.1	40	0.6	65
□ CITI PMI EPAC	12.5	59	21.1	41	0.6	59
MEDIAN	13.3		20.6		0.6	

VERMONT MUNICIPAL EMPLOYEES

INT'L DEVELOPED MKT EQUITY FUNDS - TOTAL RETURN VS RISK

5 YEARS ENDING 6/05

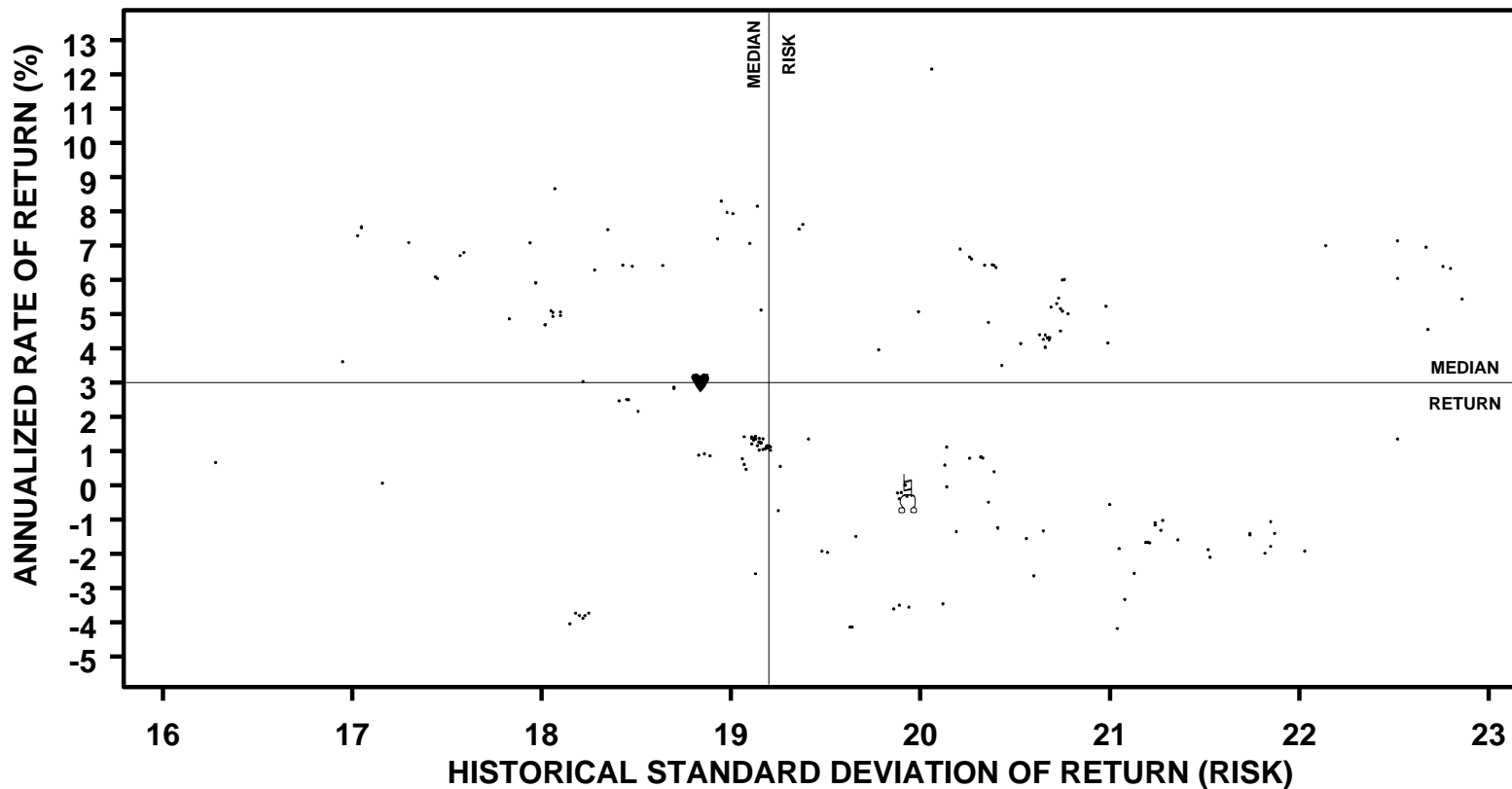

	ANNUALIZED RETURN		STANDARD DEVIATION		SHARPE RATIO	
	VALUE	RANK	VALUE	RANK	VALUE	RANK
♥ UBS	3.0	49	18.8	68	0.1	50
Ω MS EAFE NET	-0.5	76	19.9	39	-0.1	
⚡ CITI PMI EPAC	0.0	72	19.9	39	0.0	
MEDIAN	3.0		19.2		0.1	

VERMONT MUNICIPAL EMPLOYEES

INTERNATIONAL EQUITY ONLY - RATES OF RETURN

PERIODS ENDING 6/05

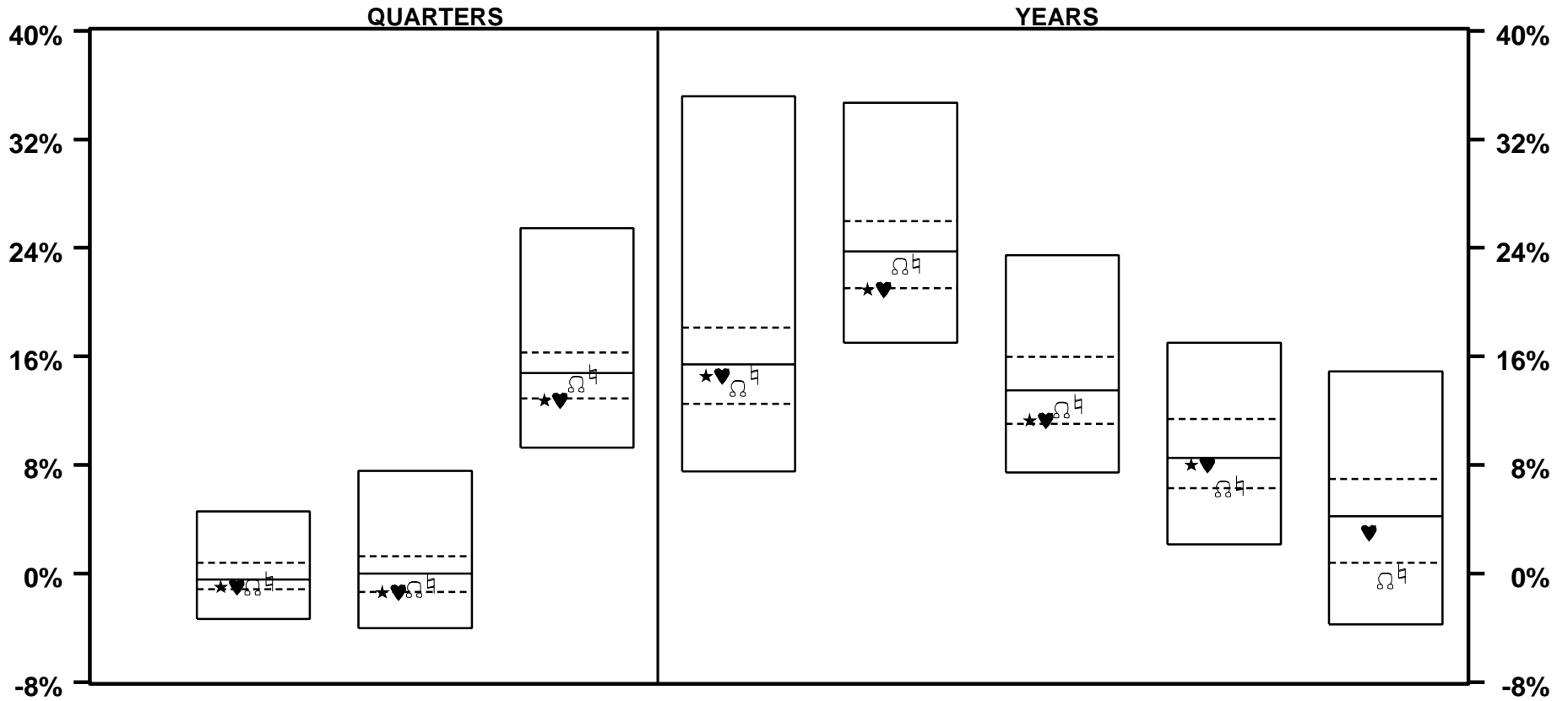

	LAST QTR		LAST 2 QTRS		LAST 3 QTRS		LAST YEAR		LAST 2 YEARS		LAST 3 YEARS		LAST 4 YEARS		LAST 5 YEARS	
★ MUNI COMPOSITE	-1.0	68	-1.4	74	12.8	75	14.6	58	20.9	75	11.3	73	8.0	52		
♥ UBS	-1.0	68	-1.4	74	12.8	75	14.6	58	20.9	75	11.3	73	8.0	52	3.0	54
Ω MS EAFE NET	-1.0	70	-1.2	70	14.0	62	13.7	63	22.7	64	12.1	69	6.2	75	-0.5	81
□ CITI PMI EPAC	-0.6	58	-0.7	61	14.7	50	14.7	58	22.9	62	12.5	65	6.5	74	0.0	78
MEDIAN	-0.4		0.0		14.8		15.4		23.7		13.5		8.5		4.2	

VERMONT MUNICIPAL EMPLOYEES

INTERNATIONAL EQUITY ONLY - RATES OF RETURN

PERIODS ENDING 6/05

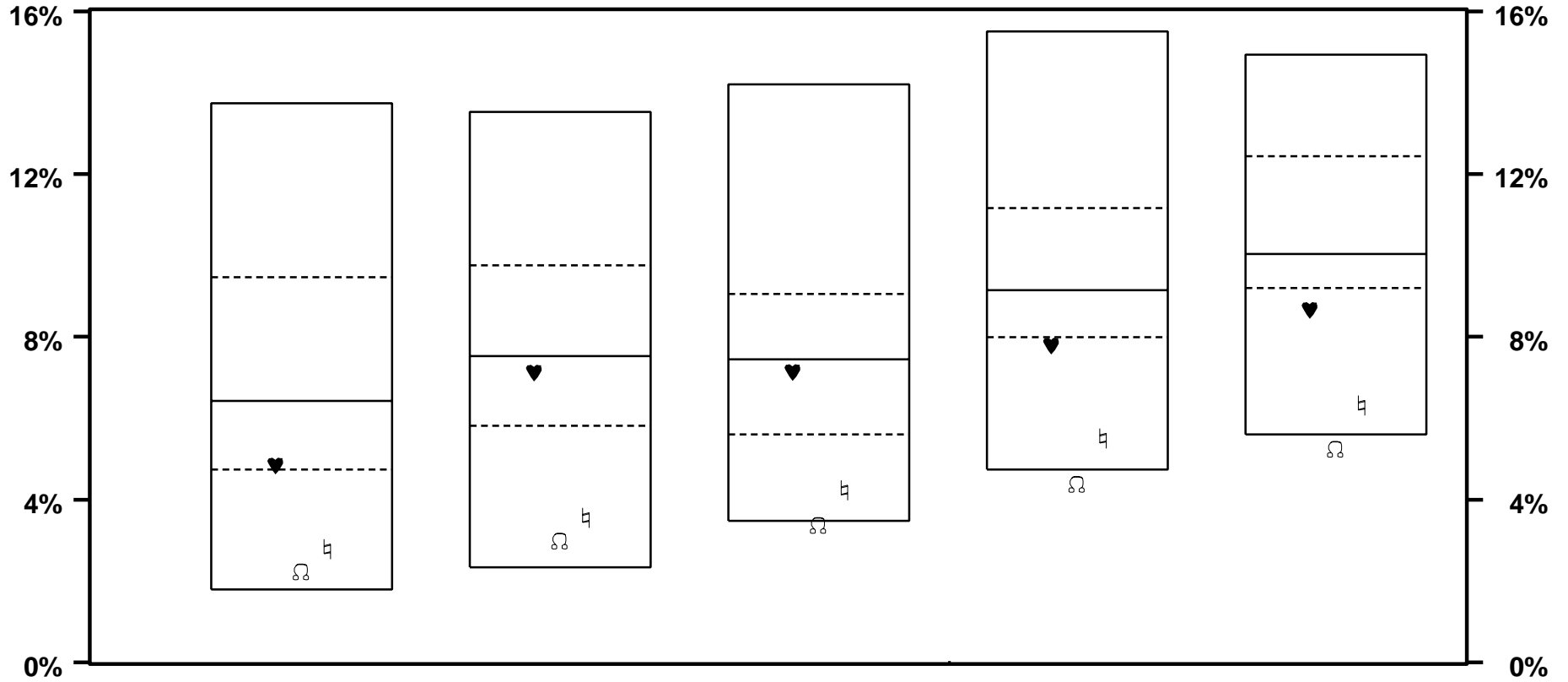

	LAST 6 YEARS		LAST 7 YEARS		LAST 8 YEARS		LAST 9 YEARS		LAST 10 YEARS	
♥ UBS	4.8	74	7.1	57	7.1	57	7.8	75	8.7	79
Ω MS EAFE NET	2.2	91	3.0	91	3.4	95	4.4	98	5.2	98
□ CITI PMI EPAC	2.8	88	3.6	87	4.2	85	5.5	91	6.3	92
MEDIAN	6.4		7.5		7.4		9.1		10.0	

VERMONT MUNICIPAL EMPLOYEES

INTERNATIONAL EQUITY ONLY - RATES OF RETURN

YEARS ENDING

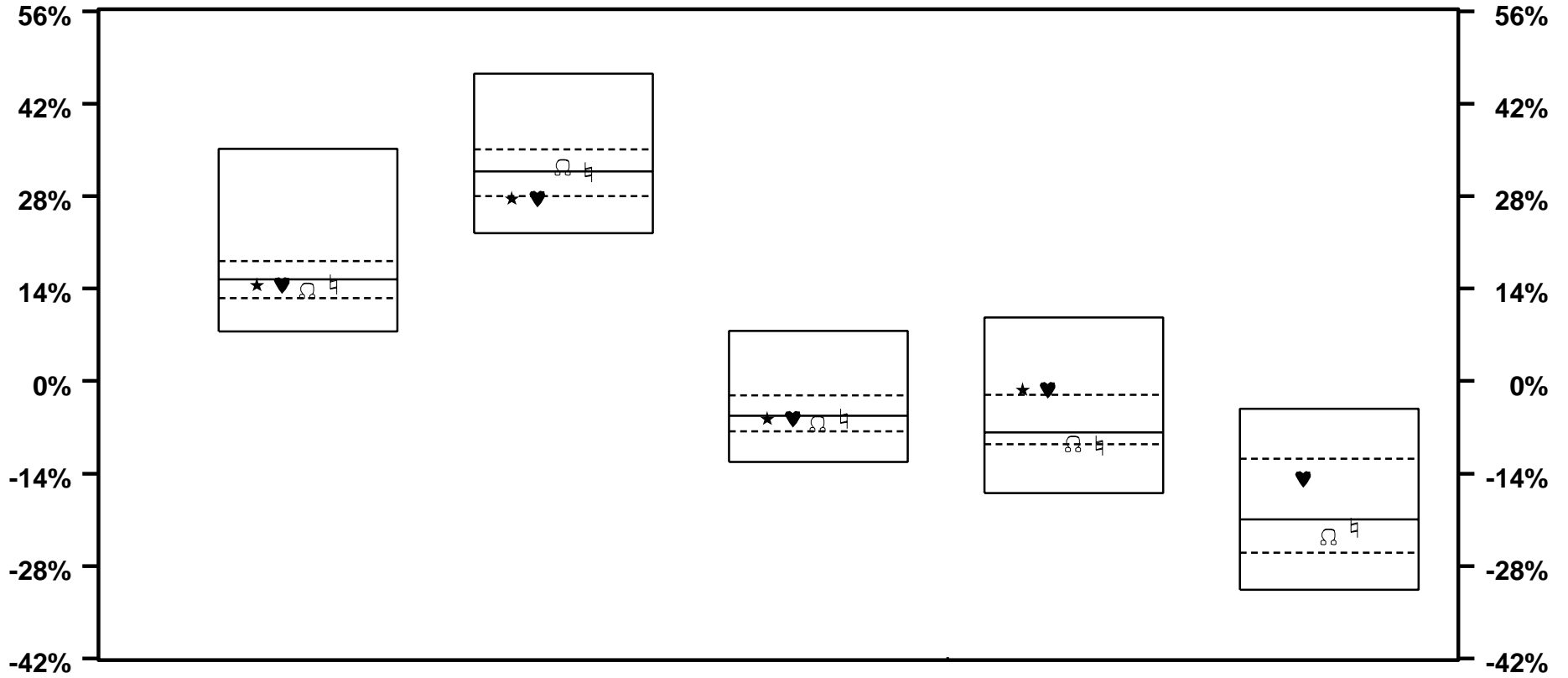

	6 / 05		6 / 04		6 / 03		6 / 02		6 / 01	
★ MUNI COMPOSITE	14.6	58	27.7	77	-5.7	53	-1.3	22		
♥ UBS	14.6	58	27.7	77	-5.7	53	-1.3	22	-14.8	31
Ω MS EAFE NET	13.7	63	32.4	37	-6.5	60	-9.5	74	-23.5	65
□ CITI PMI EPAC	14.7	58	31.6	50	-5.6	53	-9.7	76	-22.2	58
MEDIAN	15.4		31.7		-5.2		-7.8		-20.9	

VERMONT MUNICIPAL EMPLOYEES

INTERNATIONAL EQUITY ONLY - RATES OF RETURN

YEARS ENDING

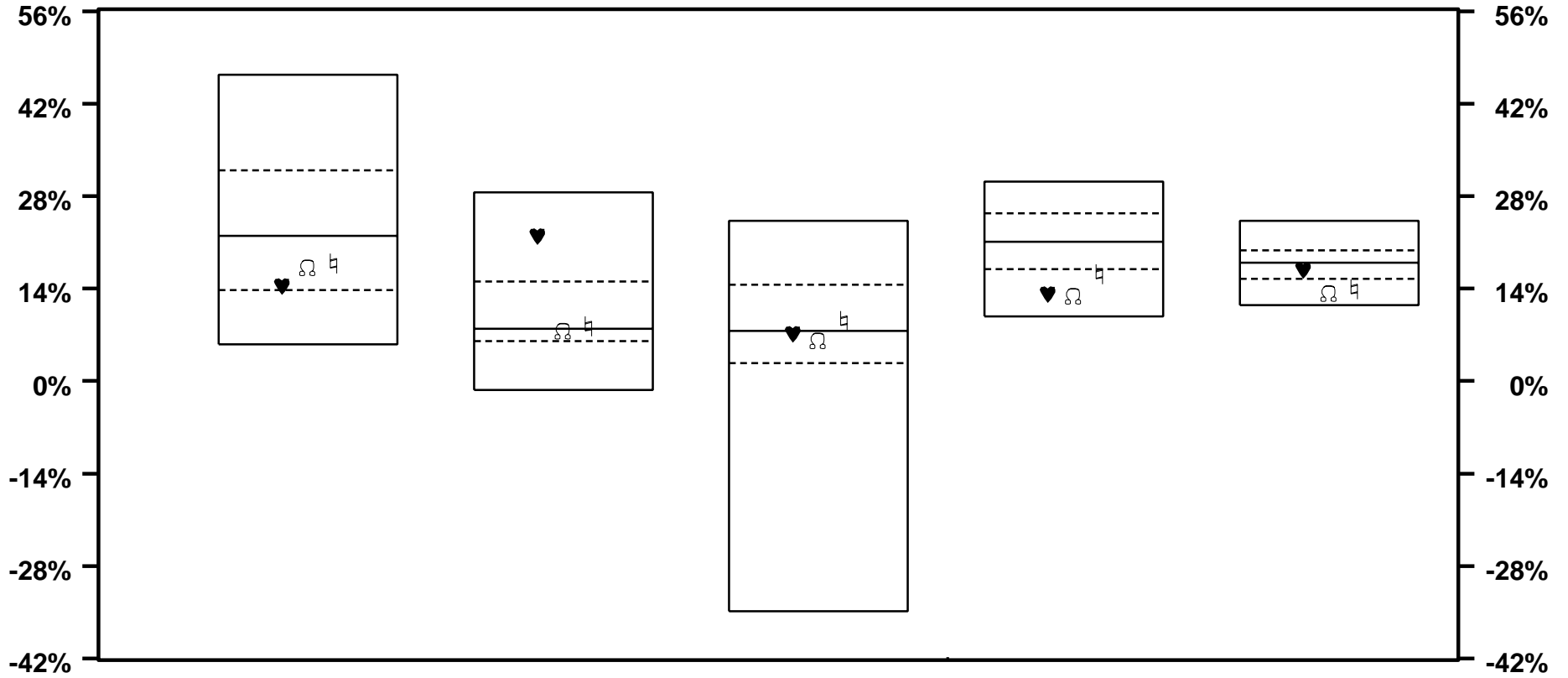

	6 / 00		6 / 99		6 / 98		6 / 97		6 / 96	
♥ UBS	14.4	72	21.9	11	7.2	54	13.2	87	16.8	65
○ MS EAFE NET	17.2	62	7.6	57	6.1	60	12.8	88	13.3	88
□ CITI PMI EPAC	17.8	58	8.3	45	9.1	44	16.2	78	14.0	83
MEDIAN	22.0		7.9		7.6		21.1		17.9	

VERMONT MUNICIPAL EMPLOYEES

PRIVATE INVESTMENT FUNDS - TOTAL RATES OF RETURN

PERIODS ENDING 6/05

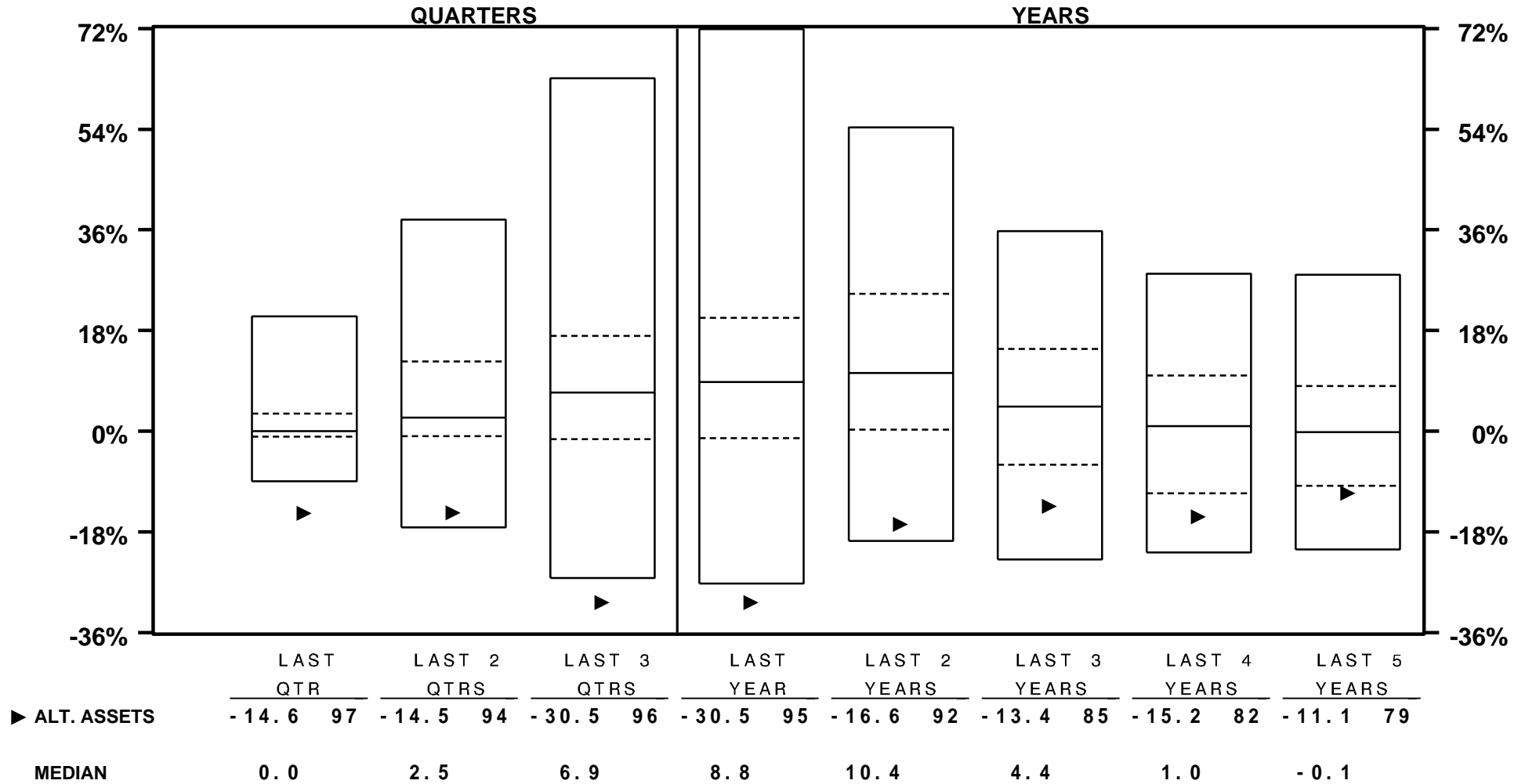

VERMONT MUNICIPAL EMPLOYEES

PRIVATE INVESTMENT FUNDS - TOTAL RATES OF RETURN

PERIODS ENDING 6/05

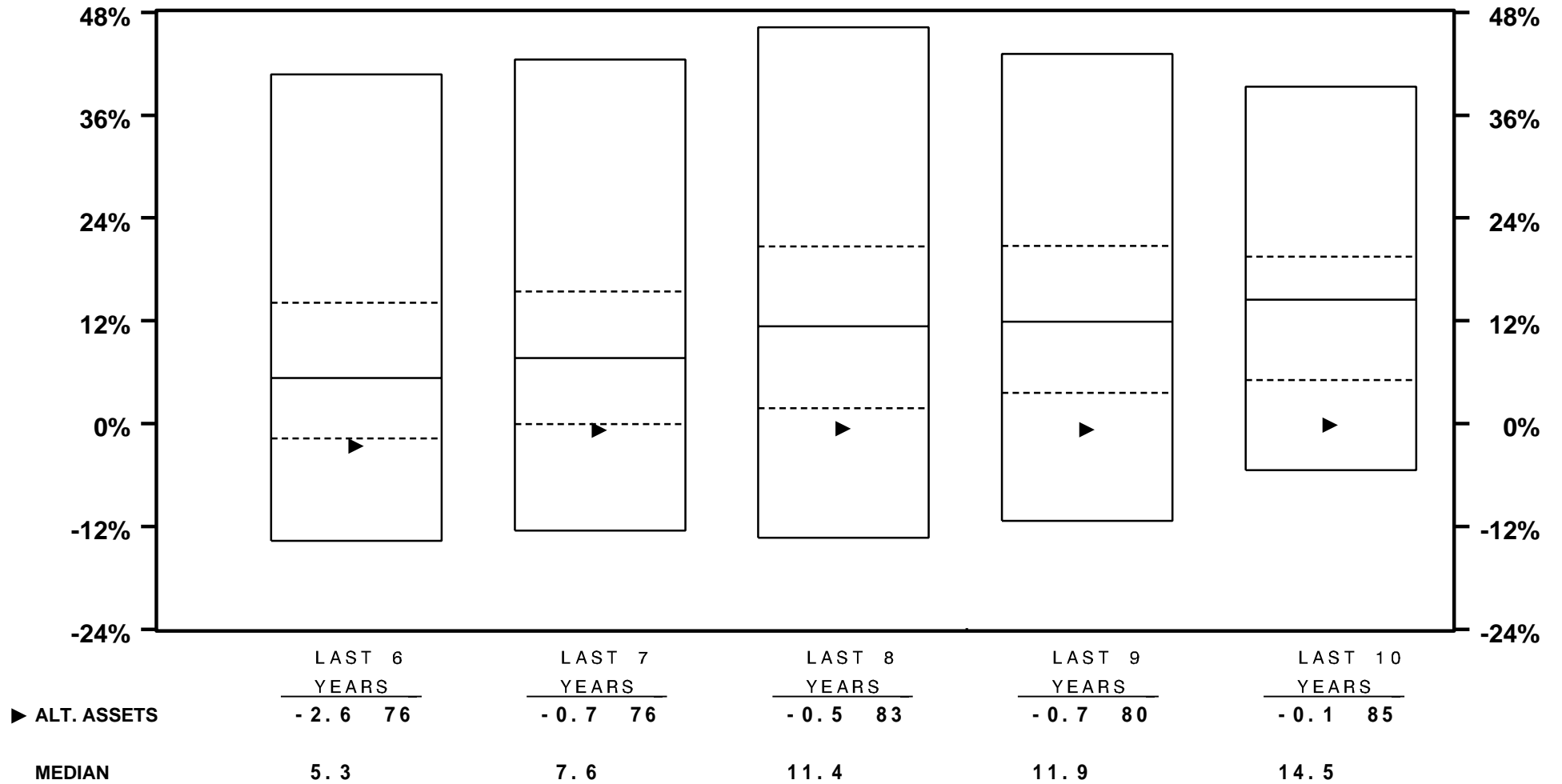

VERMONT MUNICIPAL EMPLOYEES

PRIVATE INVESTMENT FUNDS - TOTAL RATES OF RETURN

YEARS ENDING

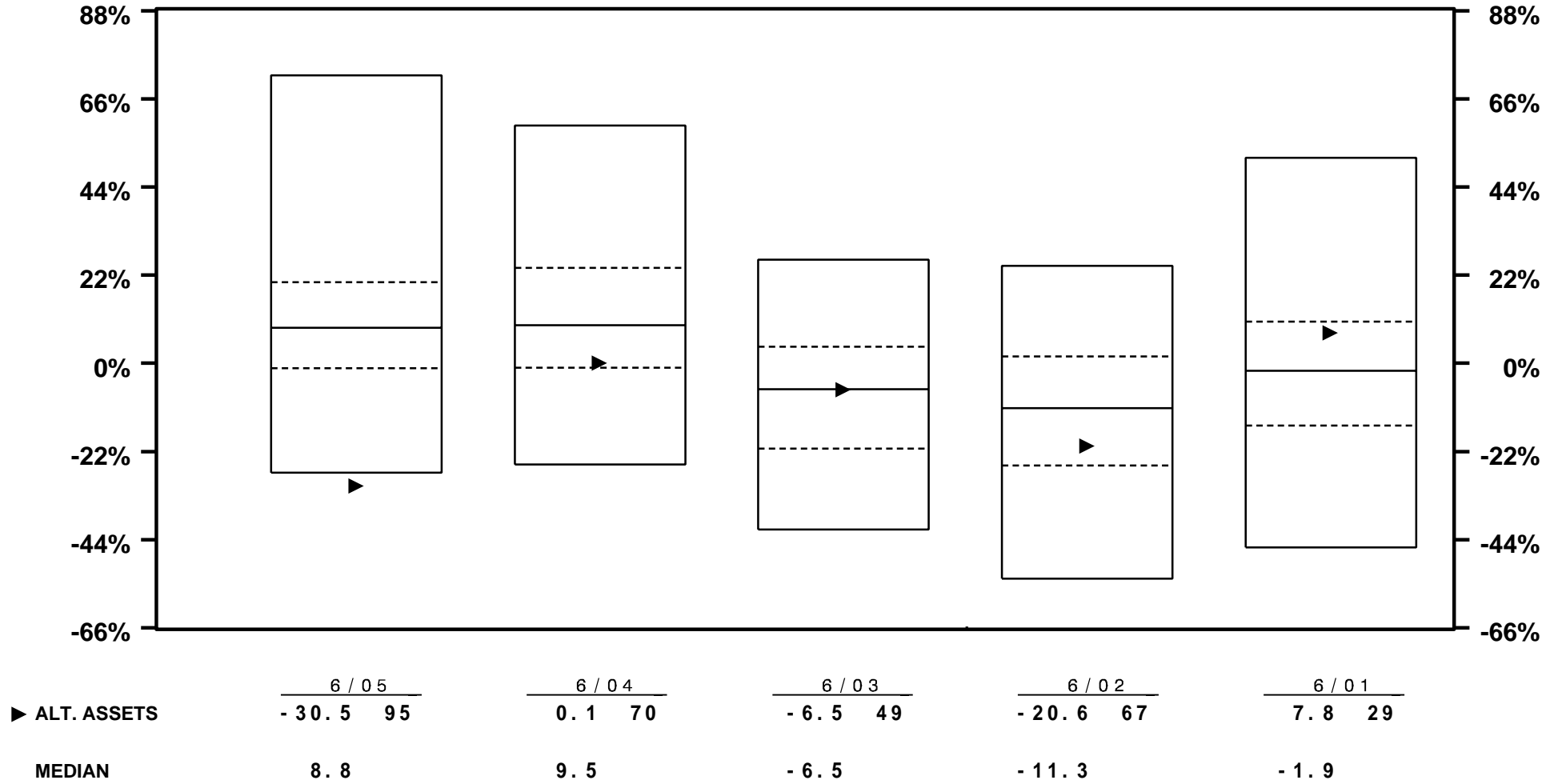

VERMONT MUNICIPAL EMPLOYEES

PRIVATE INVESTMENT FUNDS - TOTAL RATES OF RETURN

YEARS ENDING

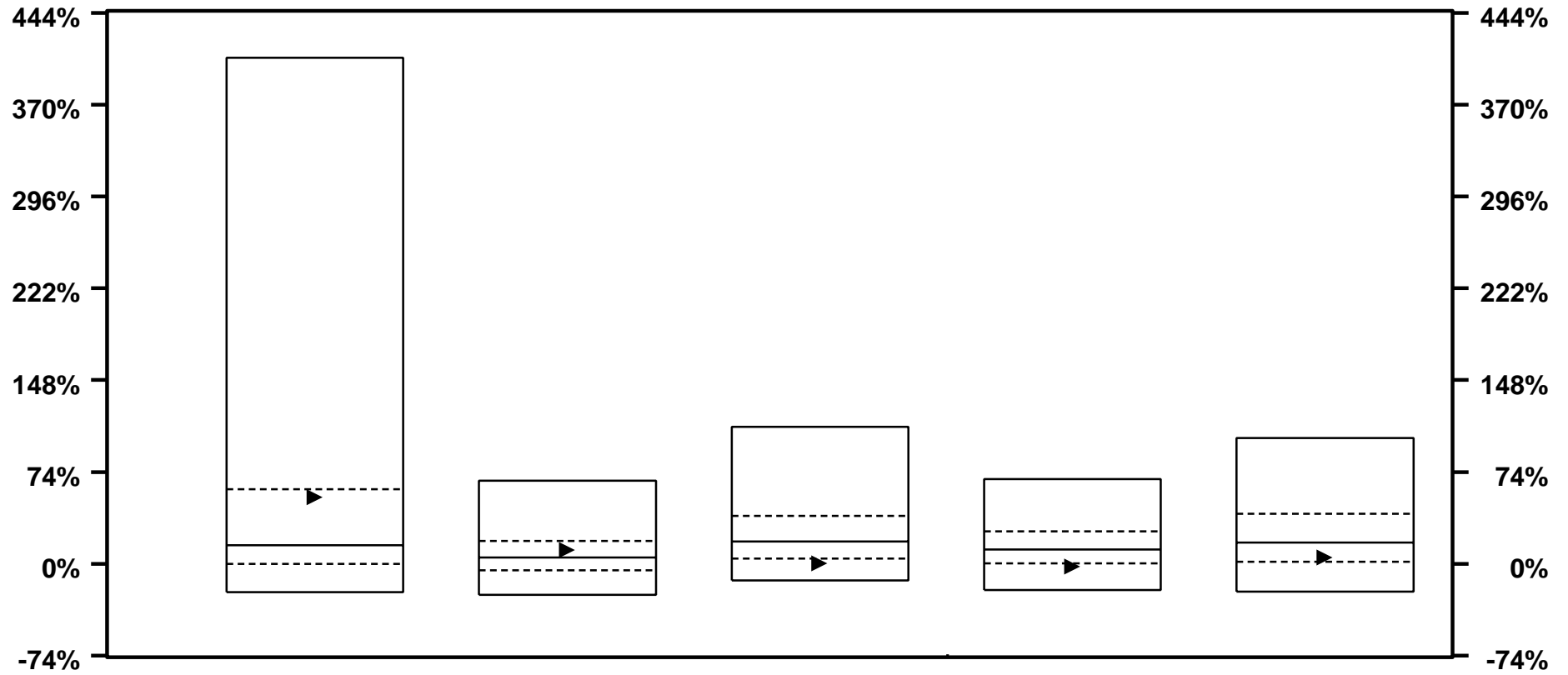

	<u>6 / 00</u>	<u>6 / 99</u>	<u>6 / 98</u>	<u>6 / 97</u>	<u>6 / 96</u>
▶ ALT. ASSETS	53.8 26	11.2 35	0.7 80	-2.0 82	5.2 71
MEDIAN	14.8	5.0	17.8	11.6	17.1

VERMONT MUNICIPAL EMPLOYEES

PRIVATE INVESTMENT FUNDS - TOTAL RETURN VS RISK

3 YEARS ENDING 6/05

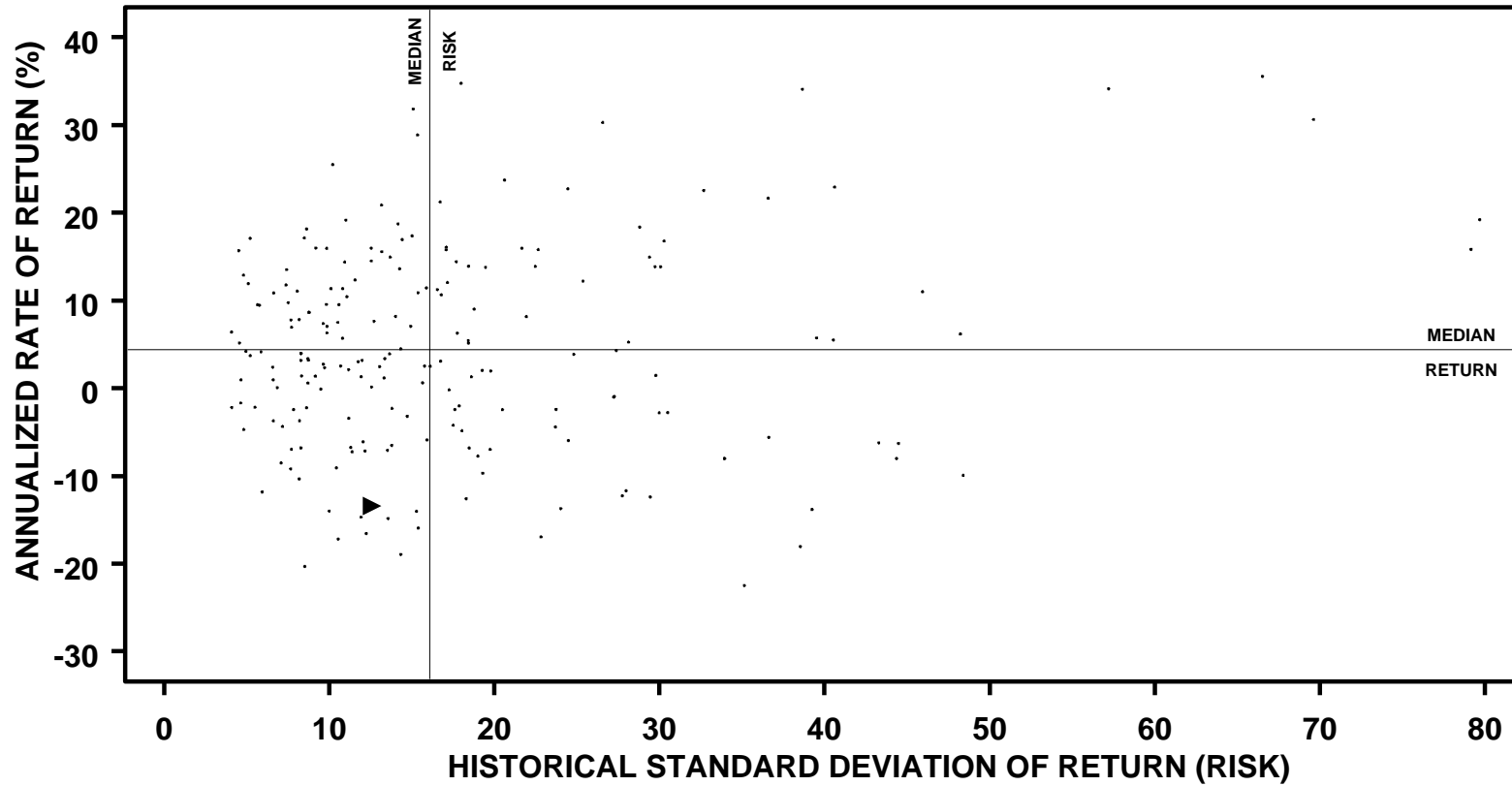

	ANNUALIZED RETURN		STANDARD DEVIATION		SHARPE RATIO	
	VALUE	RANK	VALUE	RANK	VALUE	RANK
▶ ALT. ASSETS	- 13.4	85	12.6	63	- 1.2	
MEDIAN	4.4		16.1		0.4	

VERMONT MUNICIPAL EMPLOYEES

PRIVATE INVESTMENT FUNDS - TOTAL RETURN VS RISK

5 YEARS ENDING 6/05

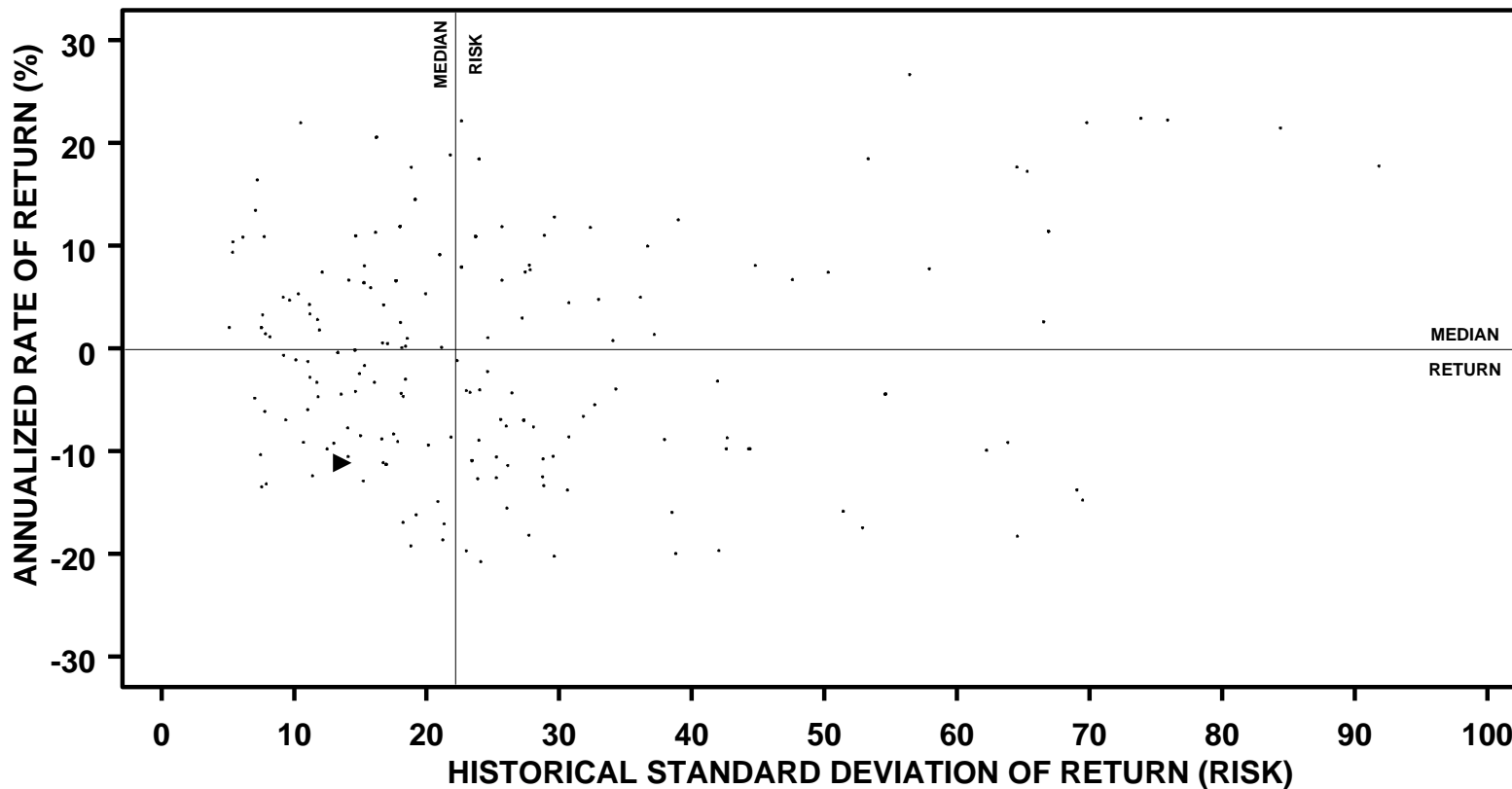

	ANNUALIZED RETURN		STANDARD DEVIATION		SHARPE RATIO	
	VALUE	RANK	VALUE	RANK	VALUE	RANK
▶ ALT. ASSETS	- 11.1	79	13.7	76	- 1.0	
MEDIAN	- 0.1		22.2		0.0	

VERMONT MUNICIPAL EMPLOYEES

PRIVATE INVESTMENTS ONLY - TOTAL RATES OF RETURN

PERIODS ENDING 6/05

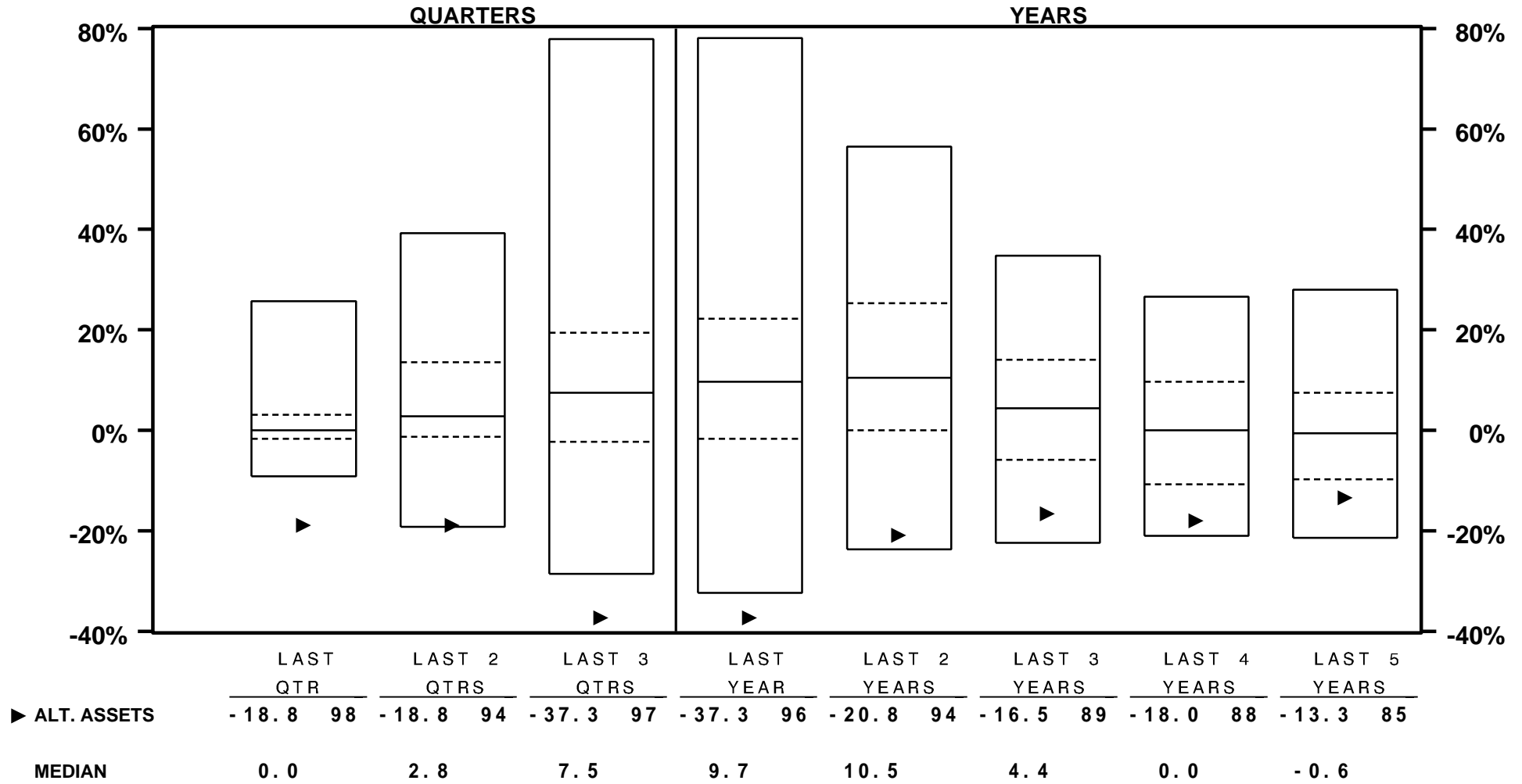

VERMONT MUNICIPAL EMPLOYEES

PRIVATE INVESTMENTS ONLY - TOTAL RATES OF RETURN

PERIODS ENDING 6/05

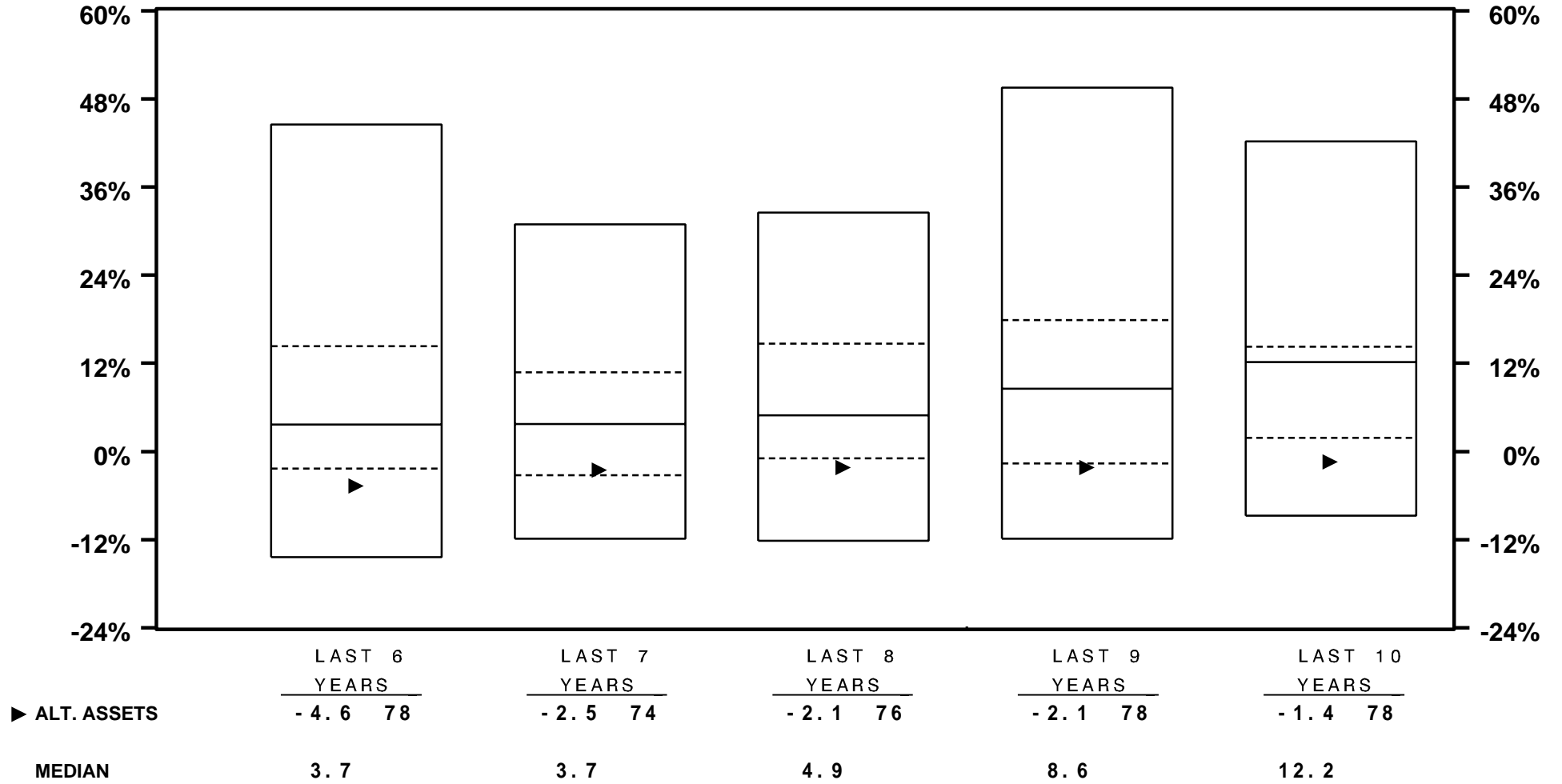

VERMONT MUNICIPAL EMPLOYEES

PRIVATE INVESTMENTS ONLY - TOTAL RATES OF RETURN

YEARS ENDING

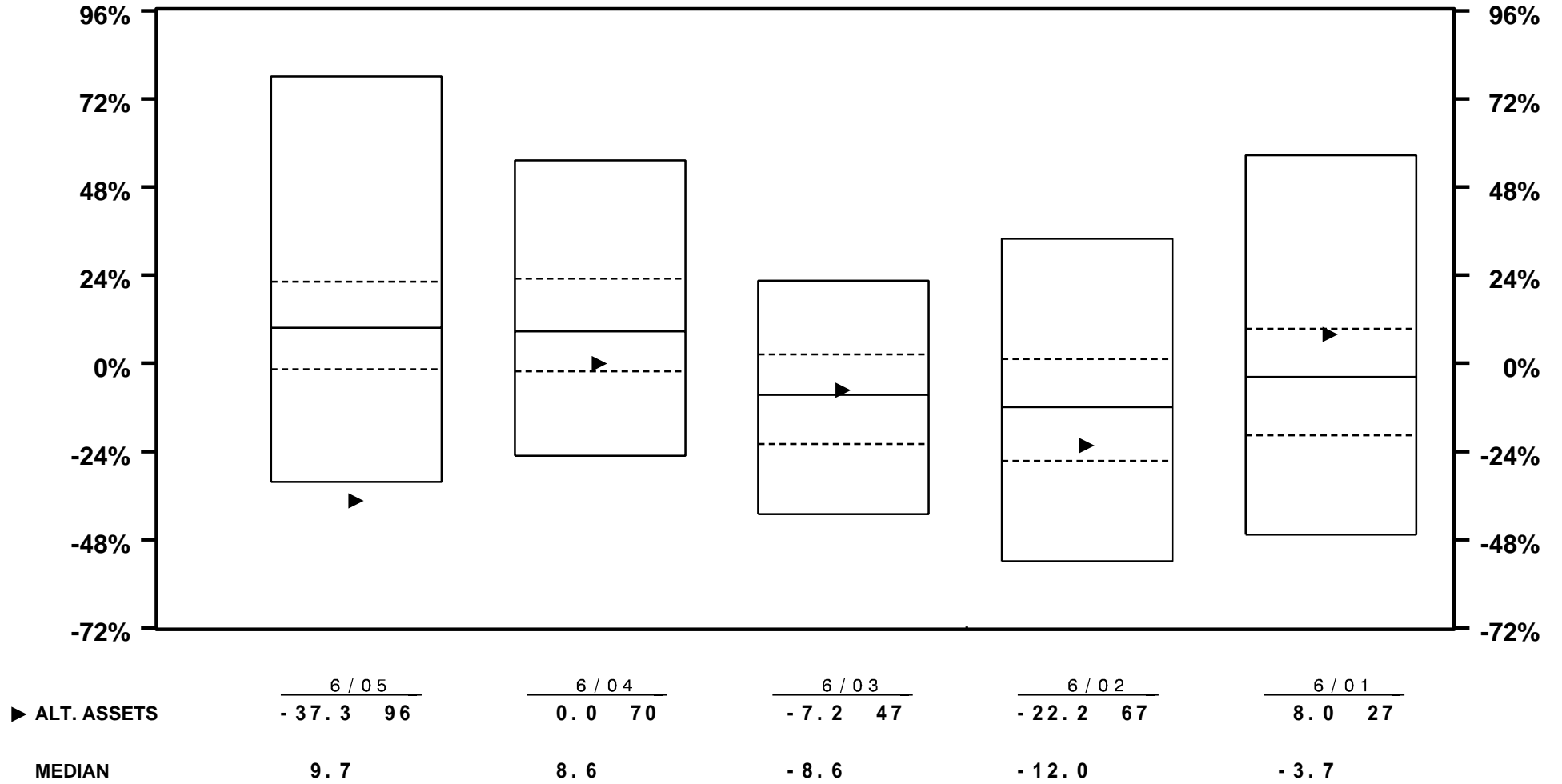

VERMONT MUNICIPAL EMPLOYEES

PRIVATE INVESTMENTS ONLY - TOTAL RATES OF RETURN

YEARS ENDING

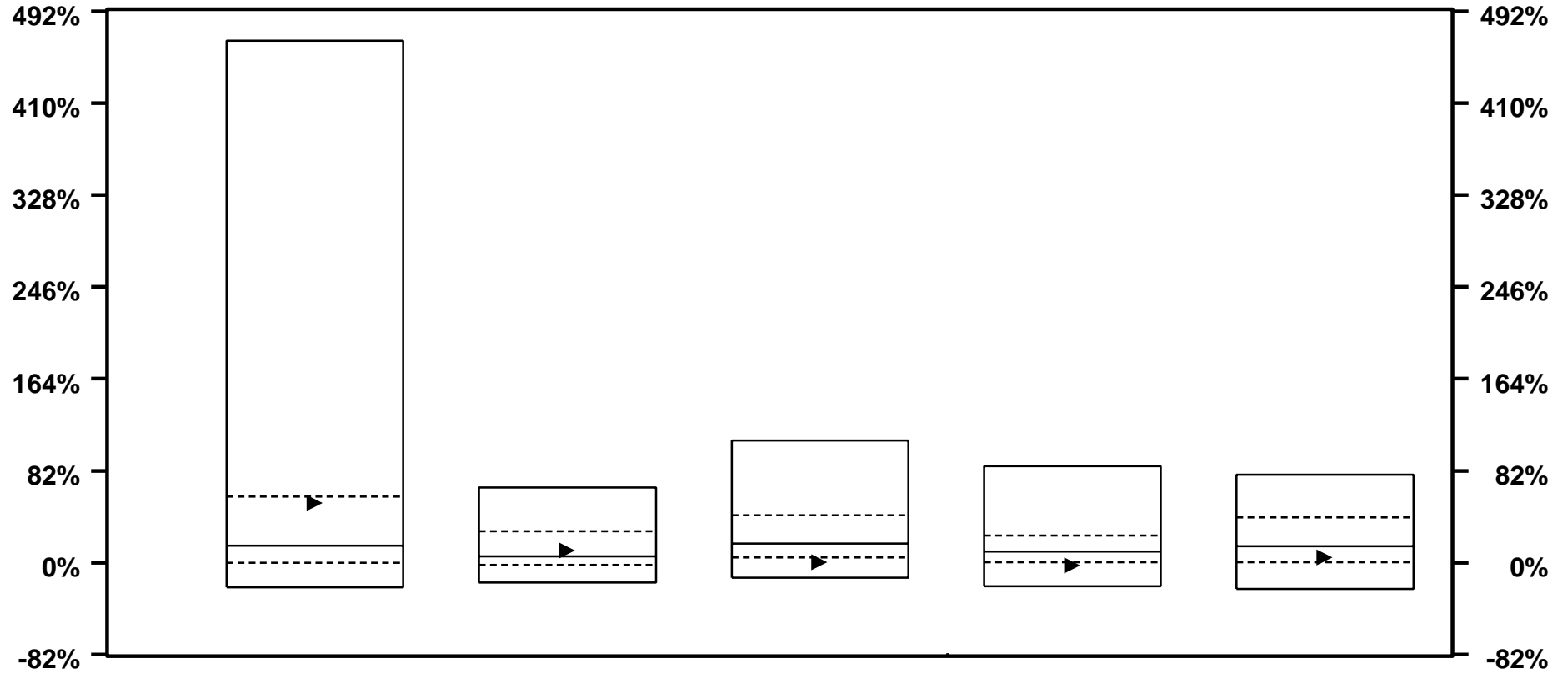

	6 / 00	6 / 99	6 / 98	6 / 97	6 / 96
▶ ALT. ASSETS	53.8 26	11.2 38	0.7 80	-2.0 80	5.2 65
MEDIAN	14.9	5.5	17.1	10.0	14.6

VERMONT MUNICIPAL EMPLOYEES

PRIVATE INVESTMENTS ONLY - TOTAL RETURN VS RISK

3 YEARS ENDING 6/05

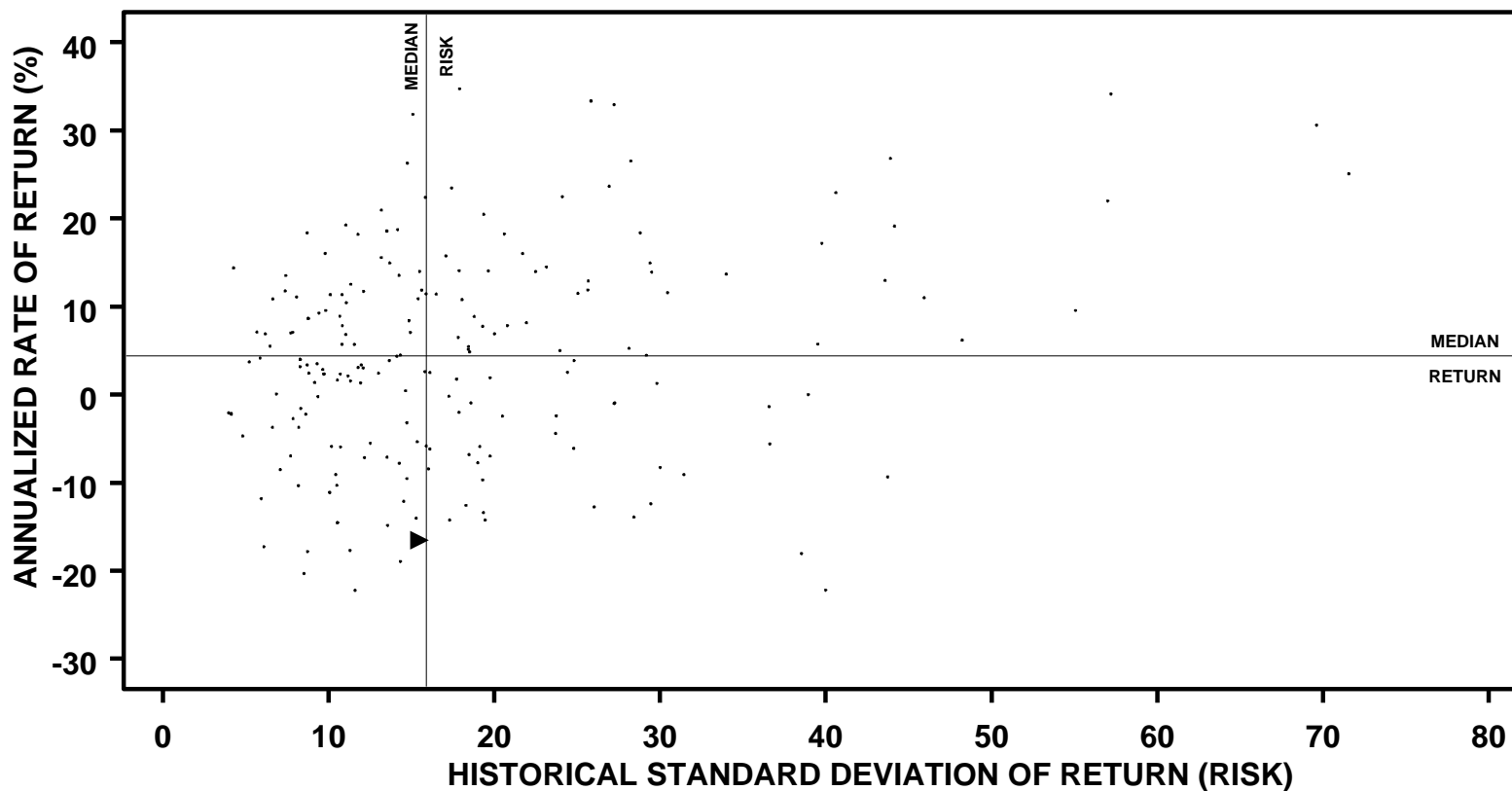

	ANNUALIZED RETURN		STANDARD DEVIATION		SHARPE RATIO	
	VALUE	RANK	VALUE	RANK	VALUE	RANK
▶ ALT. ASSETS	- 16.5	89	15.5	52	- 1.1	
MEDIAN	4.4		15.9		0.3	

VERMONT MUNICIPAL EMPLOYEES
PRIVATE INVESTMENTS ONLY - TOTAL RETURN VS RISK
5 YEARS ENDING 6/05

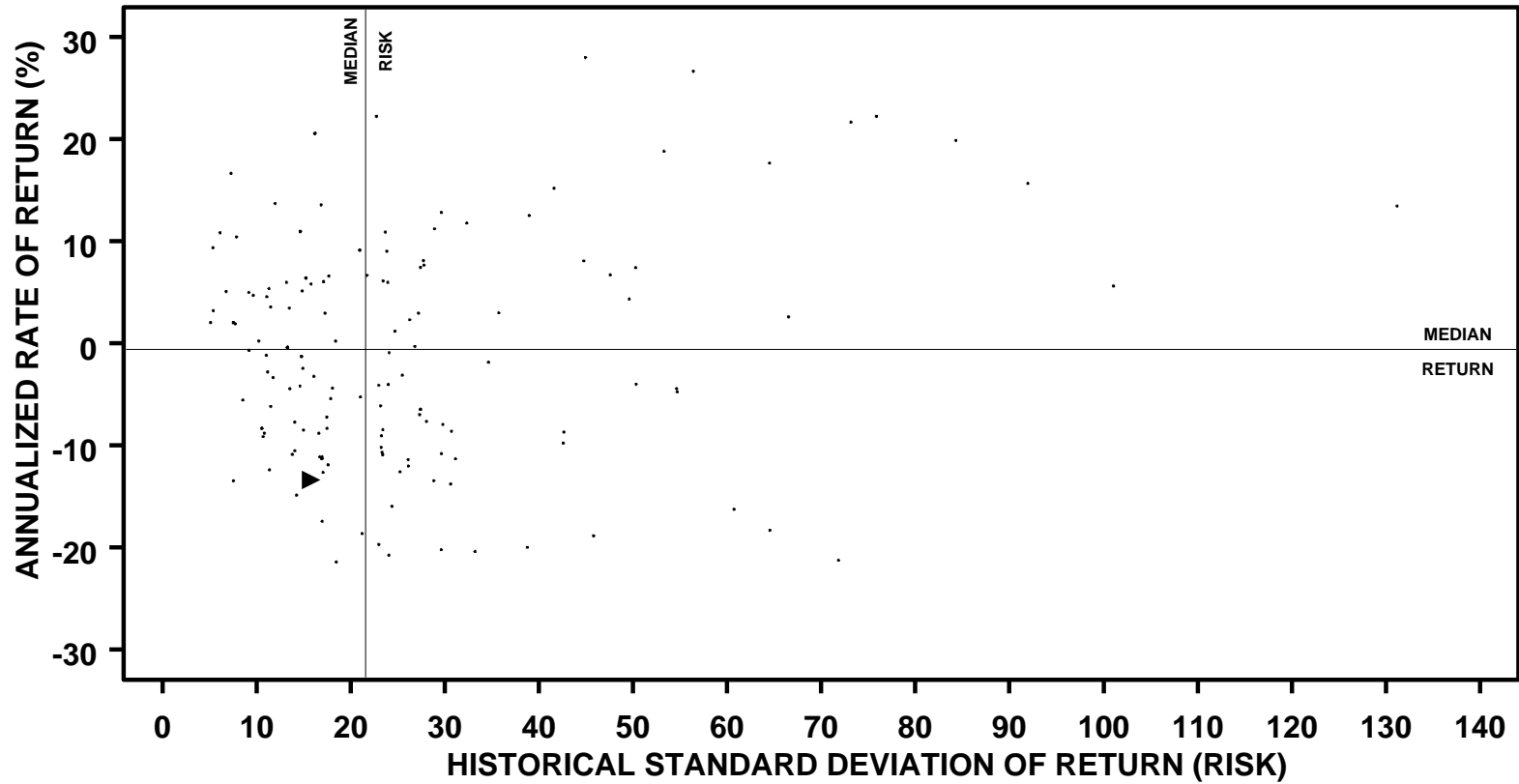

	ANNUALIZED RETURN		STANDARD DEVIATION		SHARPE RATIO	
	VALUE	RANK	VALUE	RANK	VALUE	RANK
▶ ALT. ASSETS	- 13.3	85	15.8	65	- 1.0	
MEDIAN	- 0.6		21.6		- 0.1	

VERMONT MUNICIPAL EMPLOYEES

PRIVATE EQUITY FUNDS - TOTAL RATES OF RETURN

PERIODS ENDING 6/05

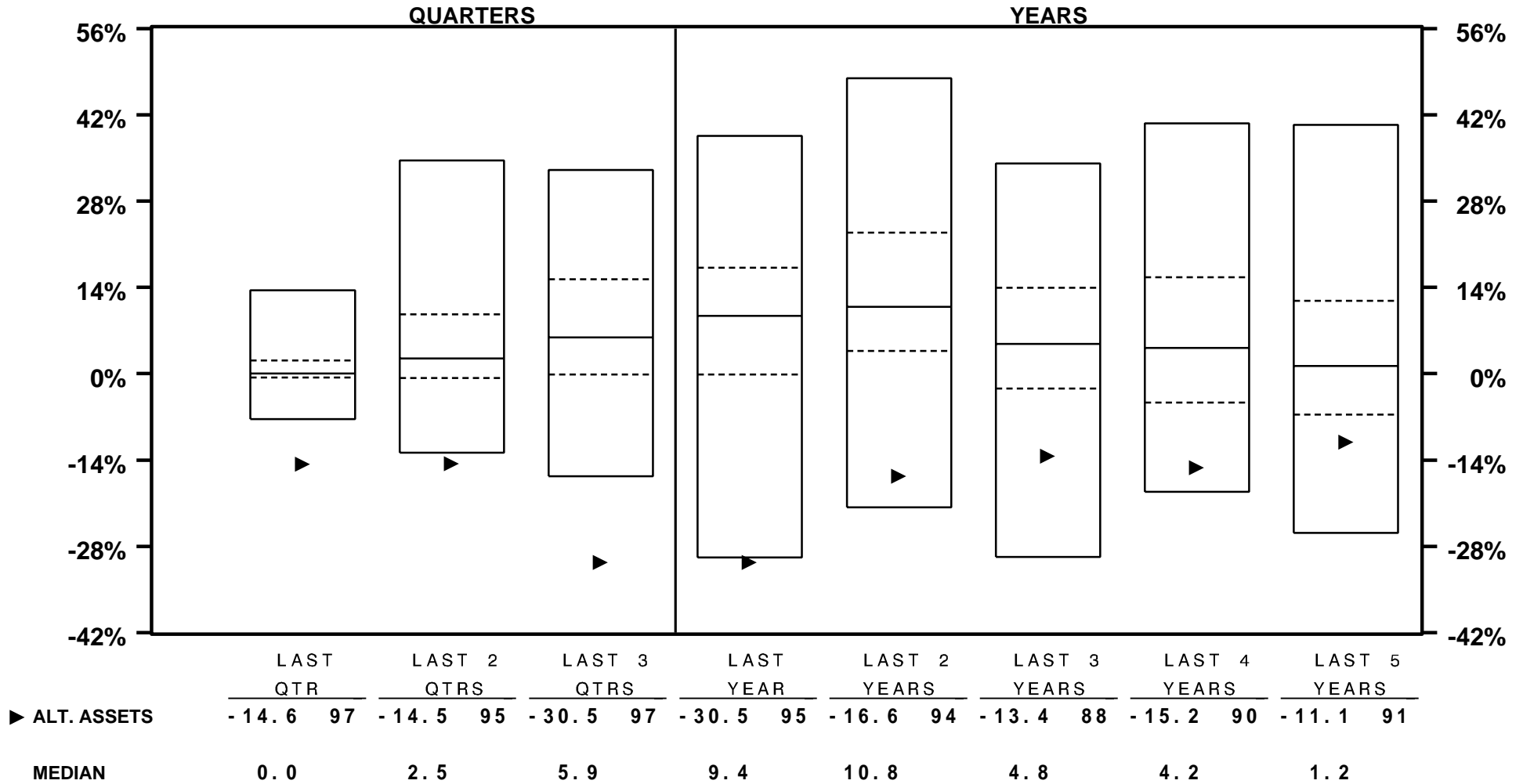

VERMONT MUNICIPAL EMPLOYEES

PRIVATE EQUITY FUNDS - TOTAL RATES OF RETURN

PERIODS ENDING 6/05

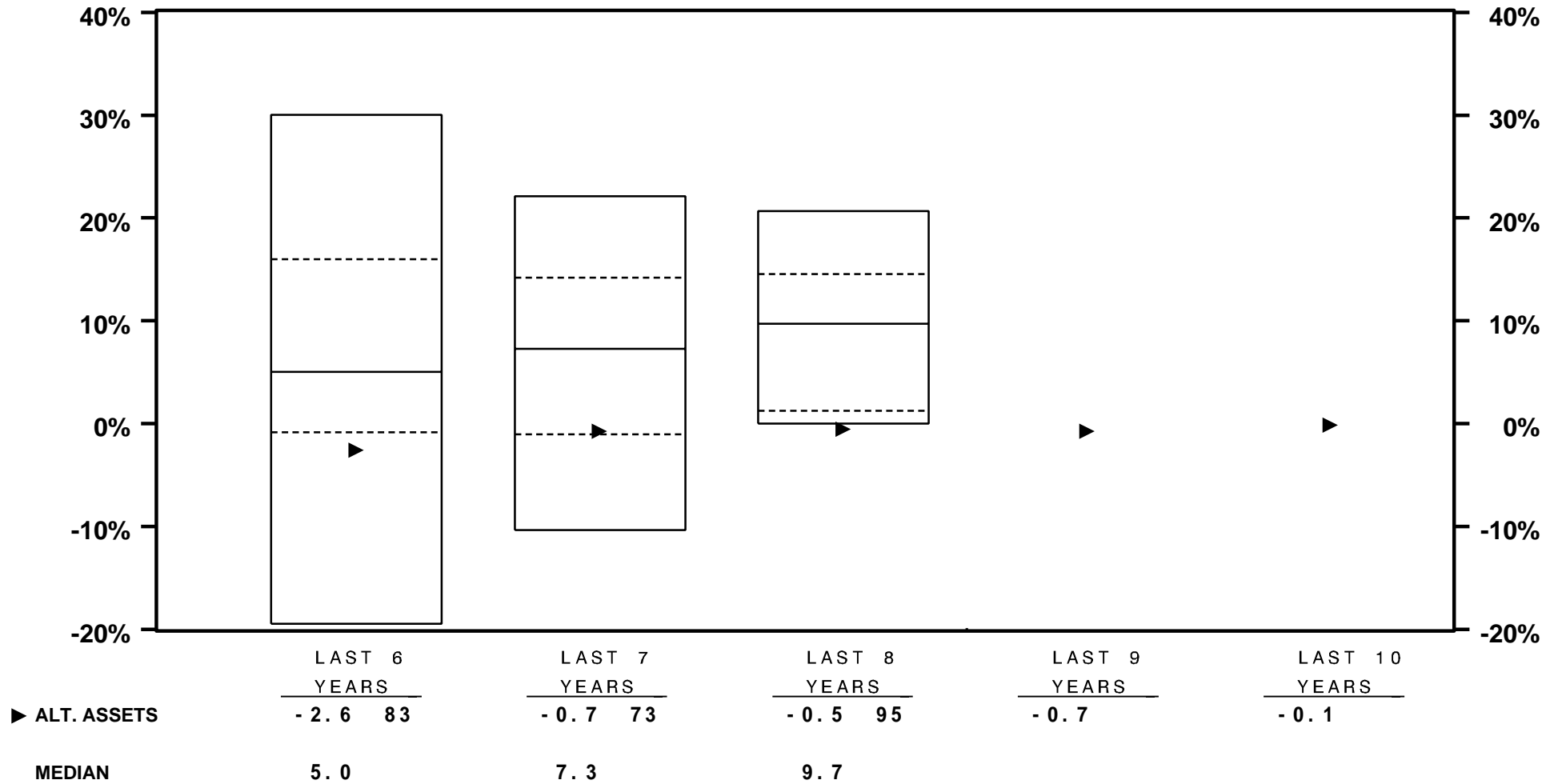

VERMONT MUNICIPAL EMPLOYEES

PRIVATE EQUITY FUNDS - TOTAL RATES OF RETURN

YEARS ENDING

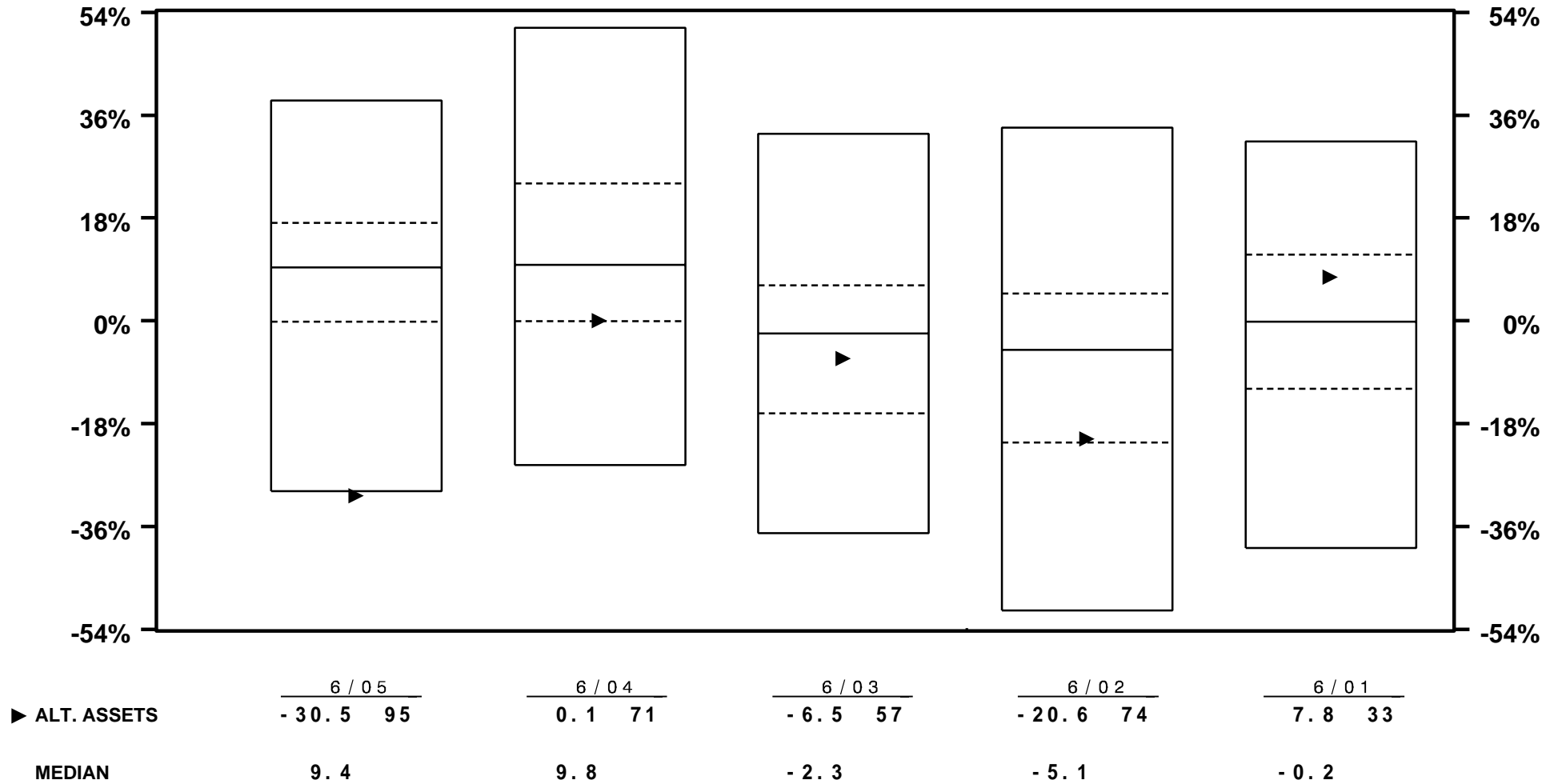

VERMONT MUNICIPAL EMPLOYEES

PRIVATE EQUITY FUNDS - TOTAL RATES OF RETURN

YEARS ENDING

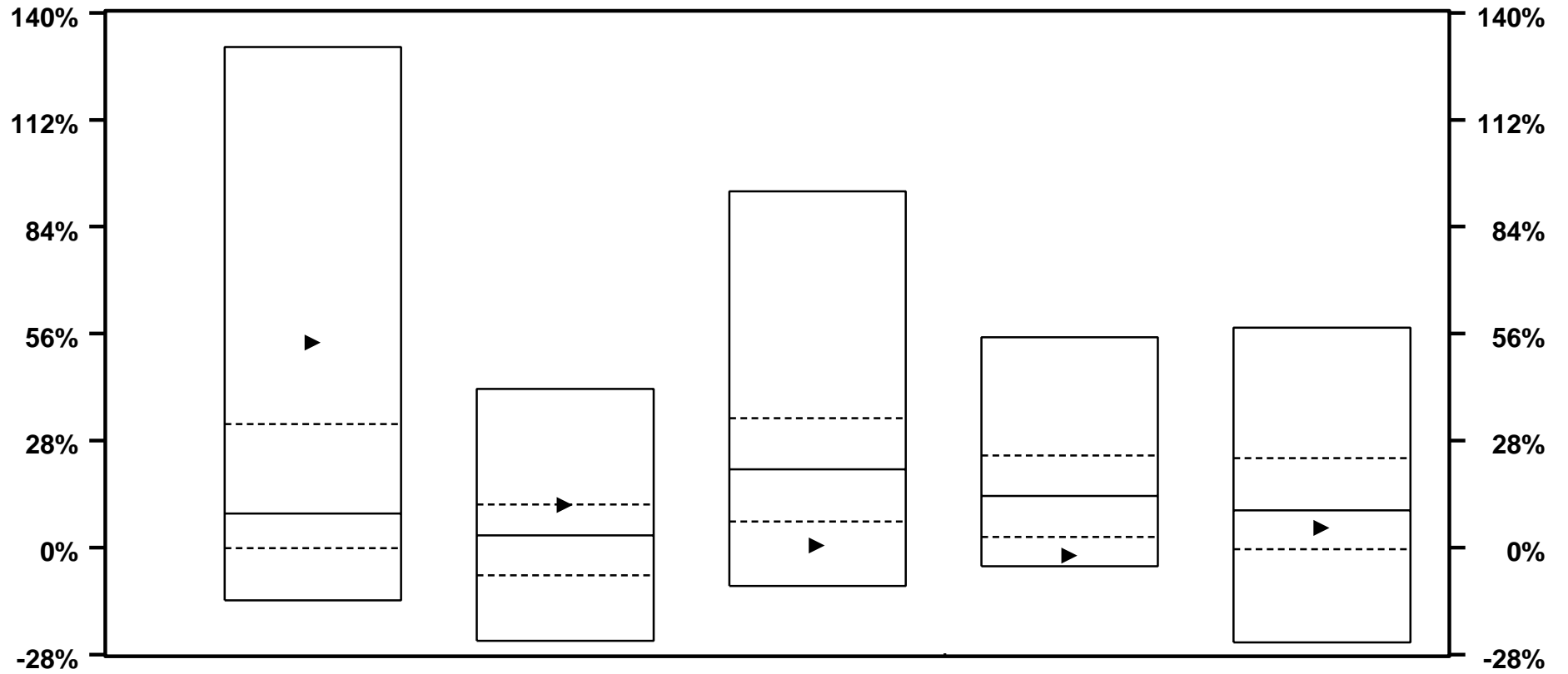

▶ ALT. ASSETS	6 / 00	6 / 99	6 / 98	6 / 97	6 / 96
	53.8 13	11.2 25	0.7 86	-2.0 88	5.2 67
MEDIAN	9.0	3.1	20.5	13.5	9.8

VERMONT MUNICIPAL EMPLOYEES

PRIVATE EQUITY FUNDS - TOTAL RETURN VS RISK

3 YEARS ENDING 6/05

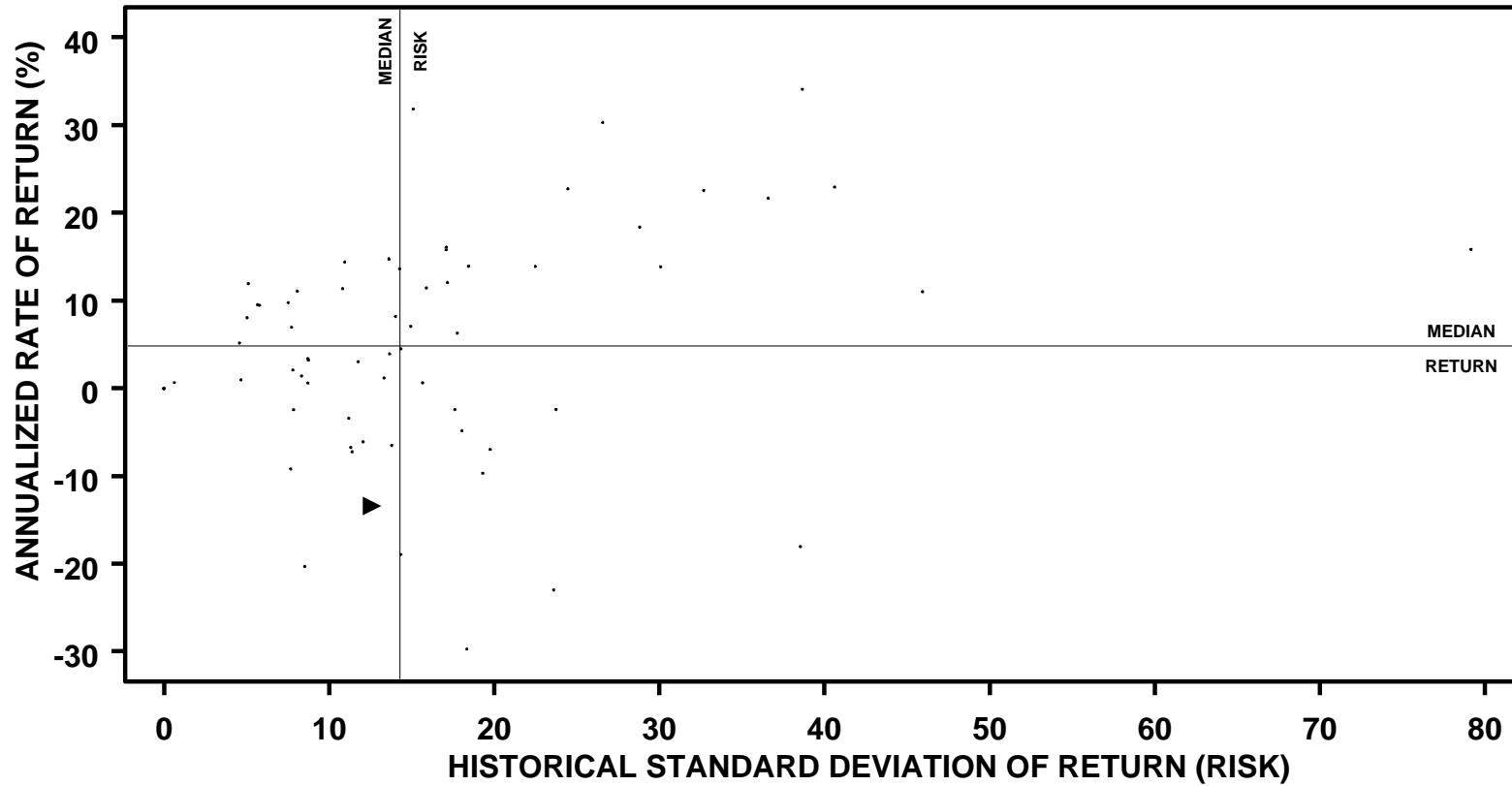

	ANNUALIZED RETURN		STANDARD DEVIATION		SHARPE RATIO	
	VALUE	RANK	VALUE	RANK	VALUE	RANK
▶ ALT. ASSETS	- 13.4	88	12.6	60	- 1.2	
MEDIAN	4.8		14.3		0.5	

VERMONT MUNICIPAL EMPLOYEES

PRIVATE EQUITY FUNDS - TOTAL RETURN VS RISK

5 YEARS ENDING 6/05

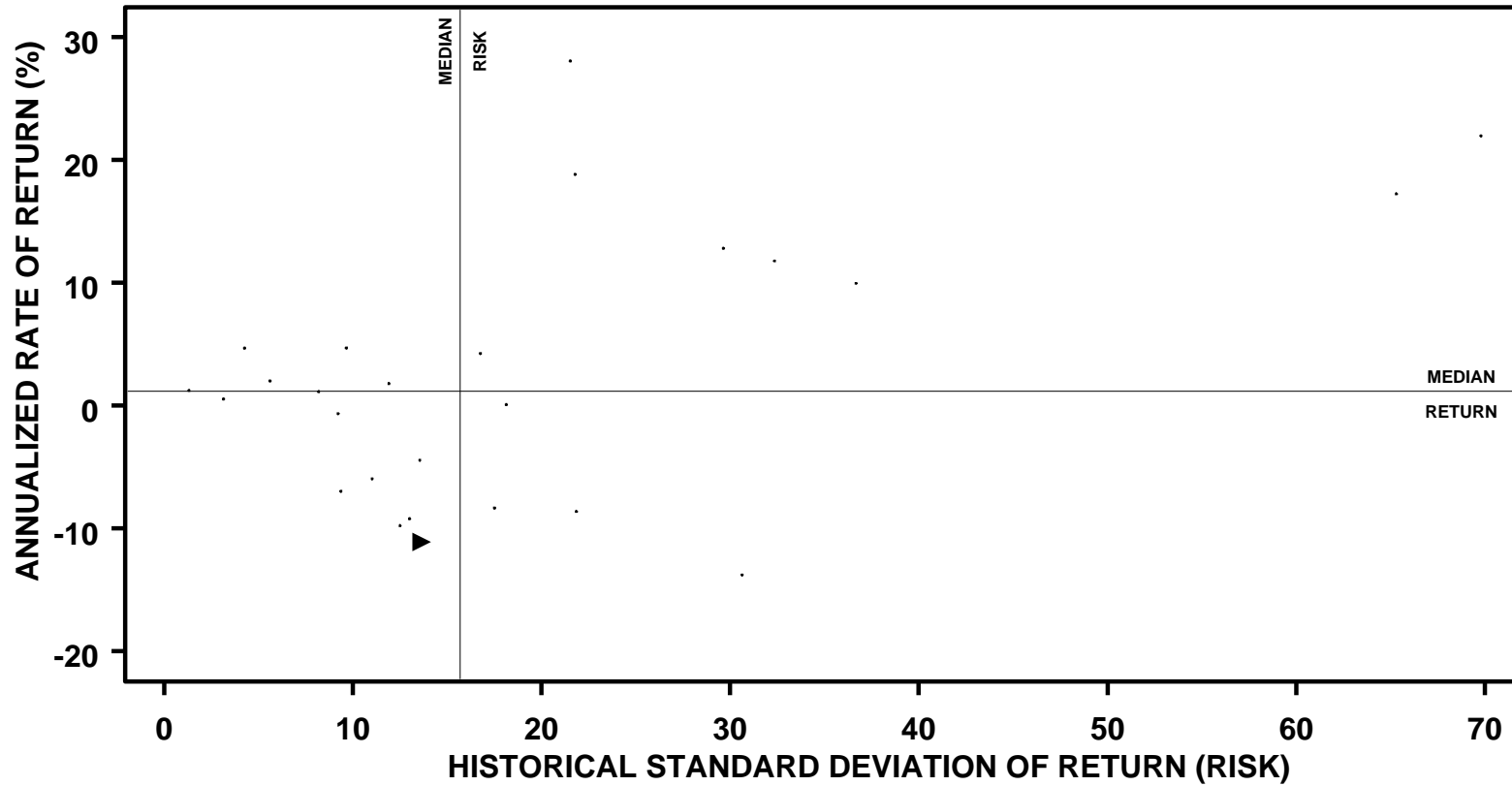

	ANNUALIZED RETURN		STANDARD DEVIATION		SHARPE RATIO	
	VALUE	RANK	VALUE	RANK	VALUE	RANK
▶ ALT. ASSETS	- 11.1	91	13.7	51	- 1.0	
MEDIAN	1.2		15.7		- 0.1	

VERMONT MUNICIPAL EMPLOYEES

REAL ESTATE FUNDS - RATES OF RETURN

PERIODS ENDING 6/05

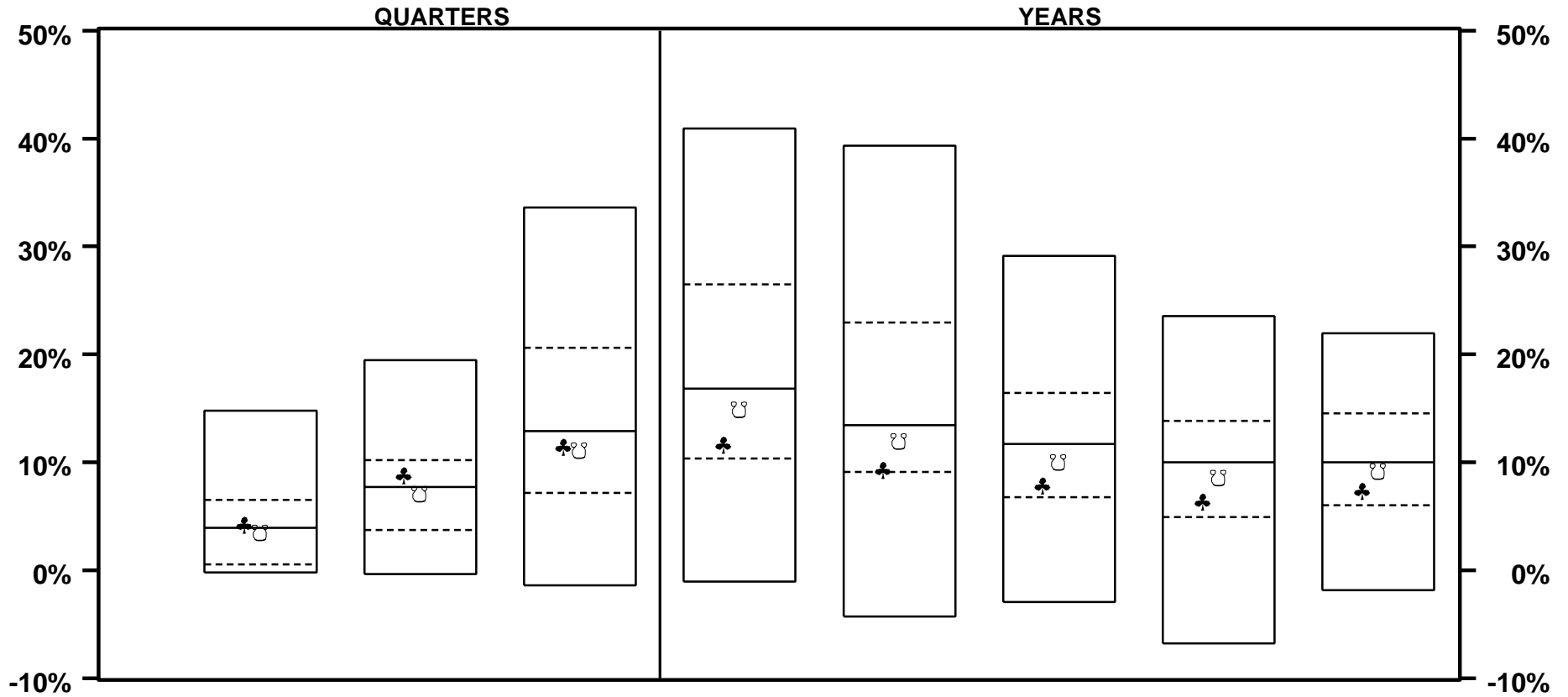

	LAST QTR		LAST 2 QTRS		LAST 3 QTRS		LAST YEAR		LAST 2 YEARS		LAST 3 YEARS		LAST 4 YEARS		LAST 5 YEARS	
♣ SSR TOWER FUND	4.2	44	8.8	33	11.4	57	11.6	70	9.3	73	7.8	71	6.4	69	7.3	69
○ NCREIF CL PROP	3.5	57	7.1	53	11.1	58	14.9	61	11.9	59	10.0	63	8.5	59	9.2	59
MEDIAN	3.9		7.7		12.9		16.8		13.4		11.7		10.0		10.0	

VERMONT MUNICIPAL EMPLOYEES

REAL ESTATE FUNDS - RATES OF RETURN

PERIODS ENDING 6/05

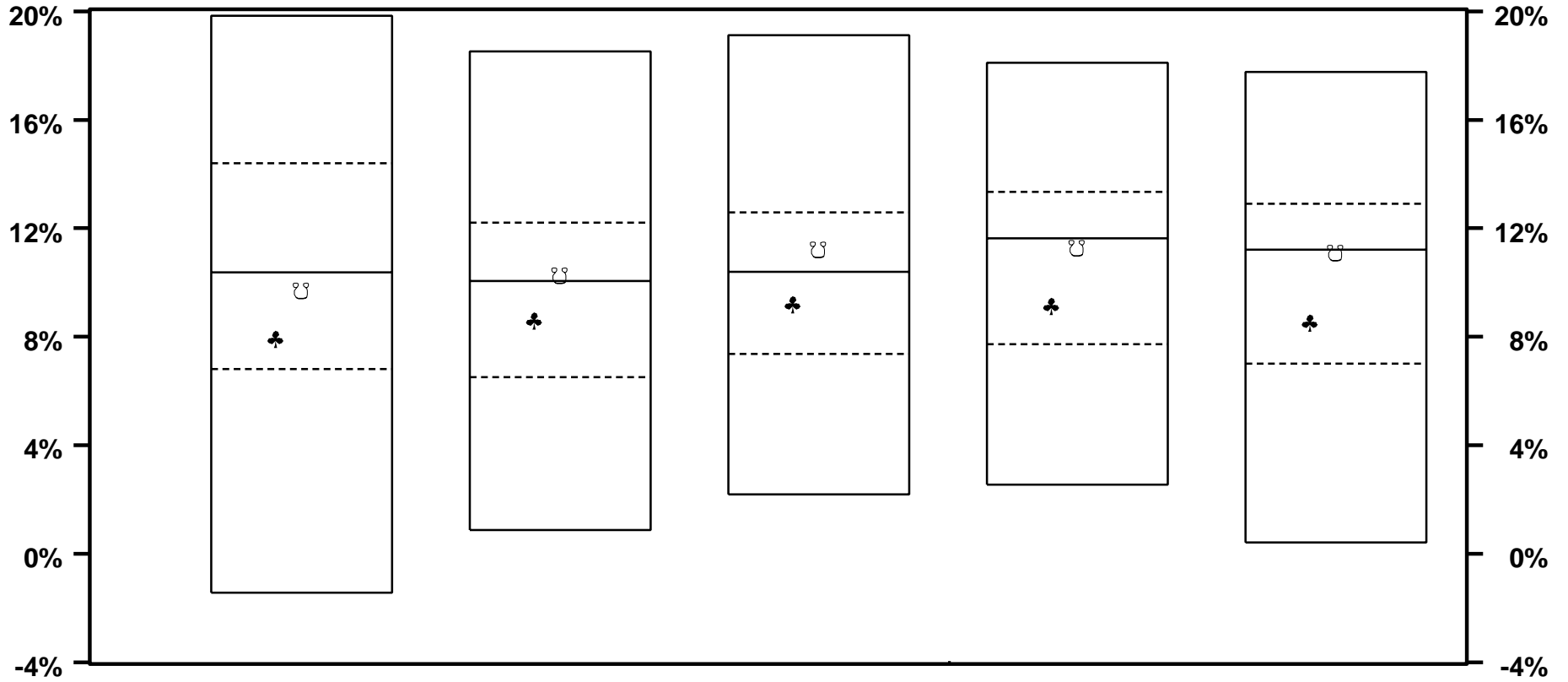

	LAST 6 YEARS		LAST 7 YEARS		LAST 8 YEARS		LAST 9 YEARS		LAST 10 YEARS	
♣ SSR TOWER FUND	7.9	68	8.6	62	9.2	62	9.1	67	8.5	70
∪ NCREIF CL PROP	9.7	57	10.3	48	11.2	42	11.3	52	11.1	52
MEDIAN	10.4		10.1		10.4		11.6		11.2	

VERMONT MUNICIPAL EMPLOYEES

REAL ESTATE FUNDS - RATES OF RETURN

YEARS ENDING

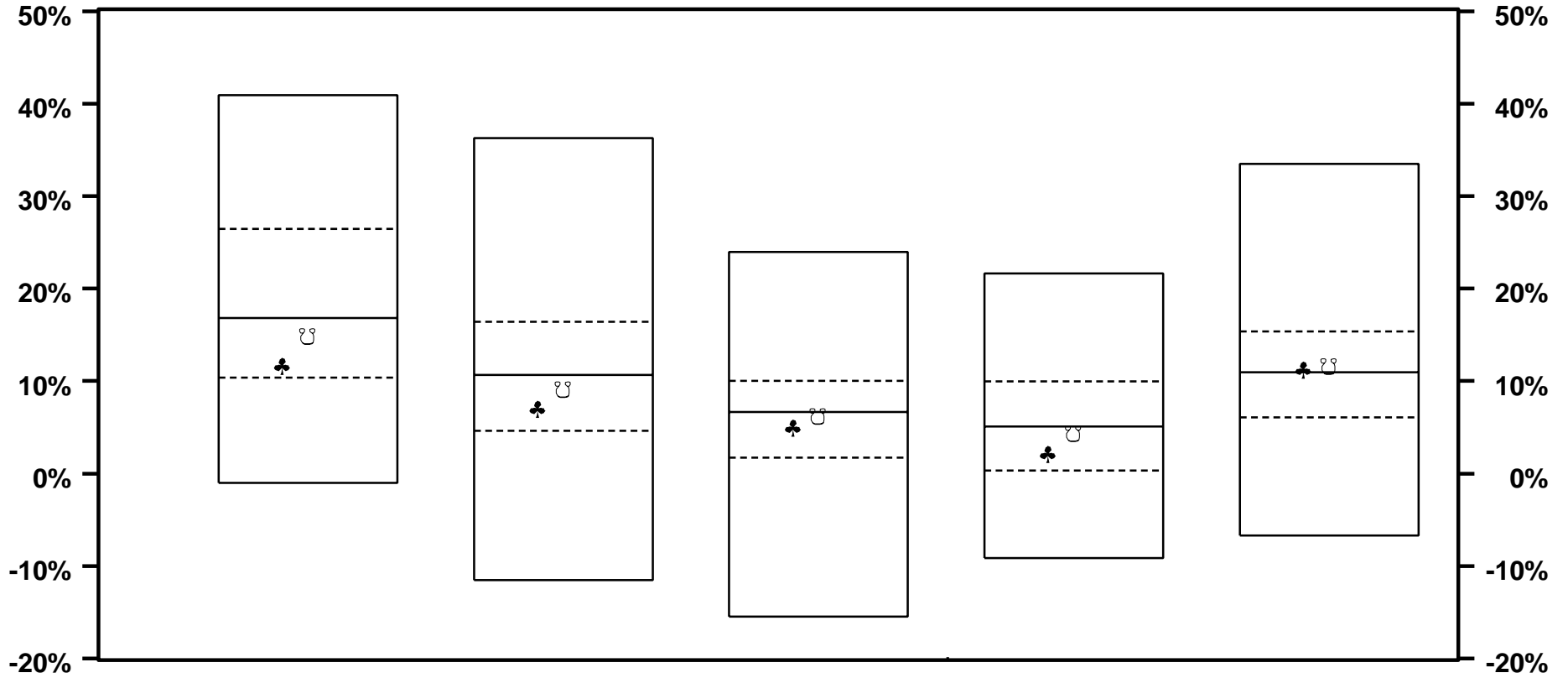

	6 / 05		6 / 04		6 / 03		6 / 02		6 / 01	
♣ SSR TOWER FUND	11.6	70	7.0	69	5.0	60	2.1	67	11.3	48
○ NCREIF CL PROP	14.9	61	9.1	56	6.2	52	4.3	52	11.6	47
MEDIAN	16.8		10.6		6.6		5.1		10.9	

VERMONT MUNICIPAL EMPLOYEES

REAL ESTATE FUNDS - RATES OF RETURN

YEARS ENDING

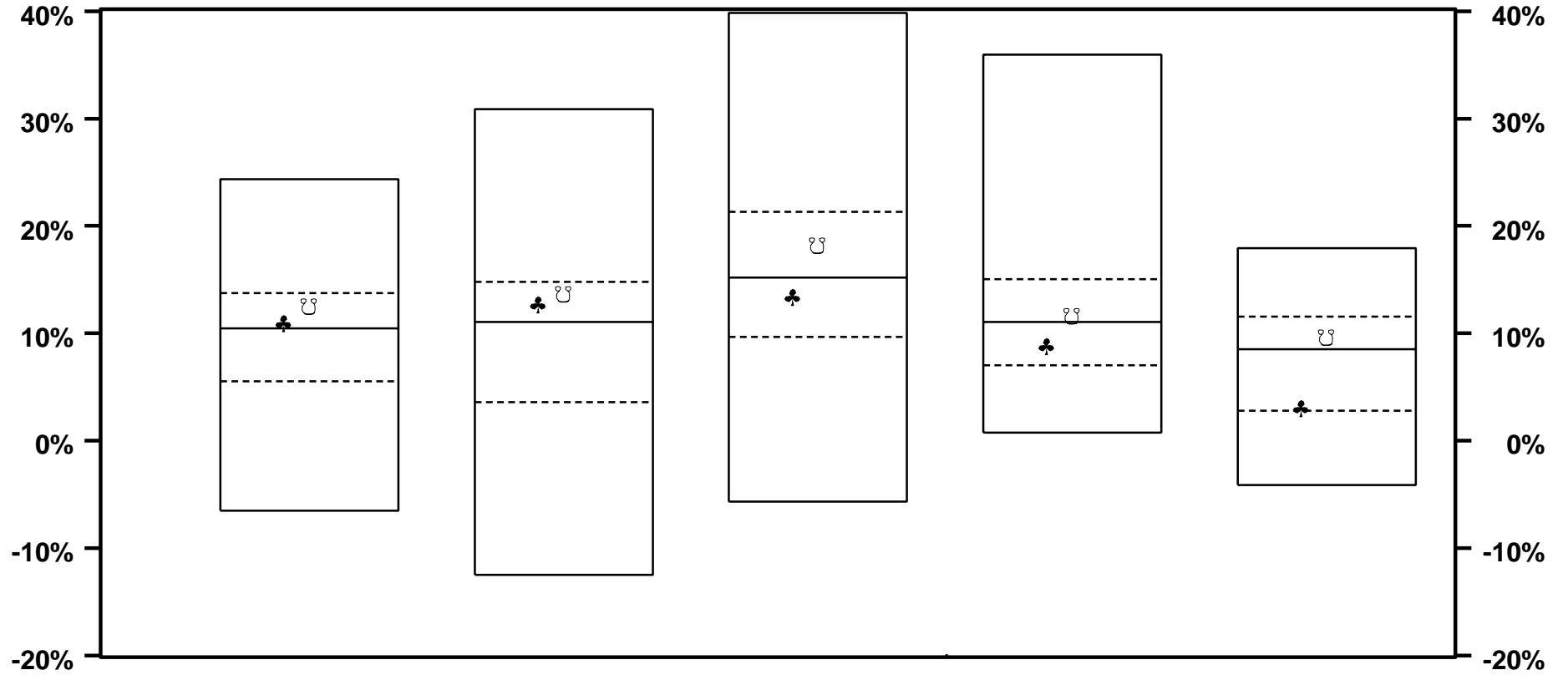

	6 / 00		6 / 99		6 / 98		6 / 97		6 / 96	
♣ SSR TOWER FUND	11.0	46	12.7	41	13.4	57	8.8	66	3.1	73
☵ NCREIF CL PROP	12.5	32	13.7	36	18.2	38	11.6	41	9.6	40
MEDIAN	10.5		11.1		15.2		11.1		8.5	

VERMONT MUNICIPAL EMPLOYEES

REAL ESTATE ONLY - RATES OF RETURN

PERIODS ENDING 6/05

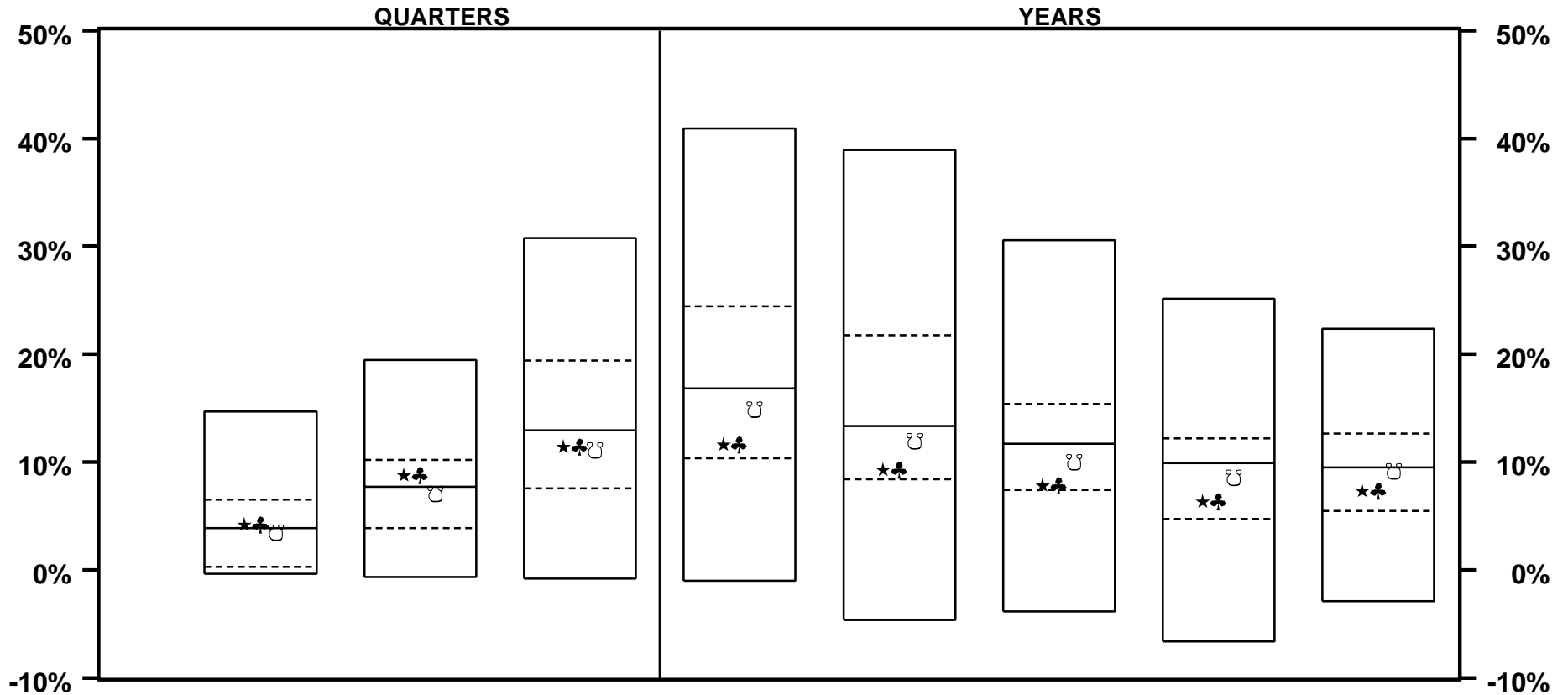

	LAST QTR		LAST 2 QTRS		LAST 3 QTRS		LAST YEAR		LAST 2 YEARS		LAST 3 YEARS		LAST 4 YEARS		LAST 5 YEARS	
★ MUNI COMPOSITE	4.2	44	8.8	35	11.4	57	11.6	69	9.3	73	7.8	74	6.4	69	7.3	68
♣ SSR TOWER FUND	4.2	44	8.8	35	11.4	57	11.6	69	9.3	73	7.8	74	6.4	69	7.3	68
⊖ NCREIF CL PROP	3.5	57	7.1	53	11.1	58	14.9	60	11.9	60	10.0	65	8.5	59	9.2	59
MEDIAN	3.9		7.7		12.9		16.8		13.3		11.7		9.9		9.5	

VERMONT MUNICIPAL EMPLOYEES

REAL ESTATE ONLY - RATES OF RETURN

PERIODS ENDING 6/05

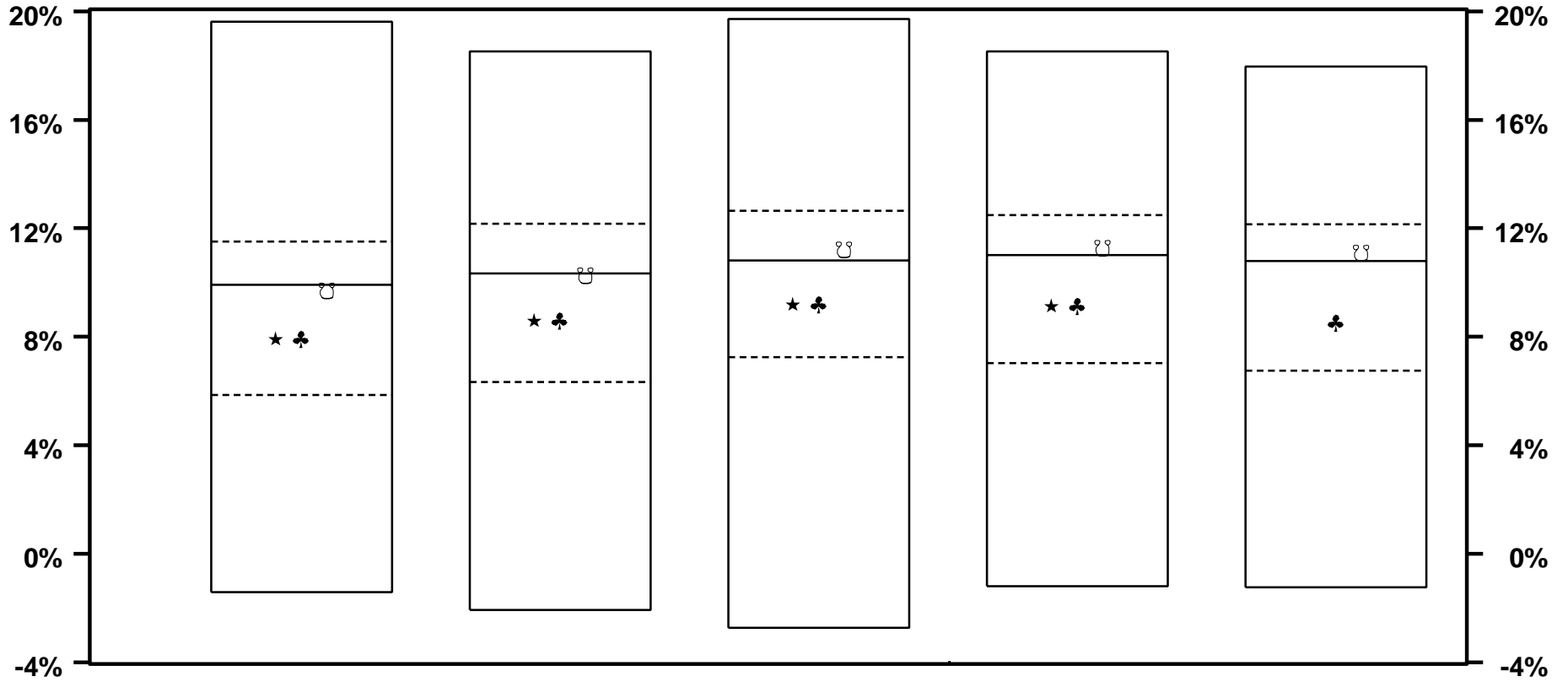

	LAST 6 YEARS		LAST 7 YEARS		LAST 8 YEARS		LAST 9 YEARS		LAST 10 YEARS	
★ MUNI COMPOSITE	7.9	66	8.6	61	9.2	63	9.1	64		
♣ SSR TOWER FUND	7.9	66	8.6	61	9.2	63	9.1	64	8.5	68
○ NCREIF CL PROP	9.7	54	10.3	50	11.2	43	11.3	45	11.1	44
MEDIAN	9.9		10.3		10.8		11.0		10.8	

VERMONT MUNICIPAL EMPLOYEES

REAL ESTATE ONLY - RATES OF RETURN

YEARS ENDING

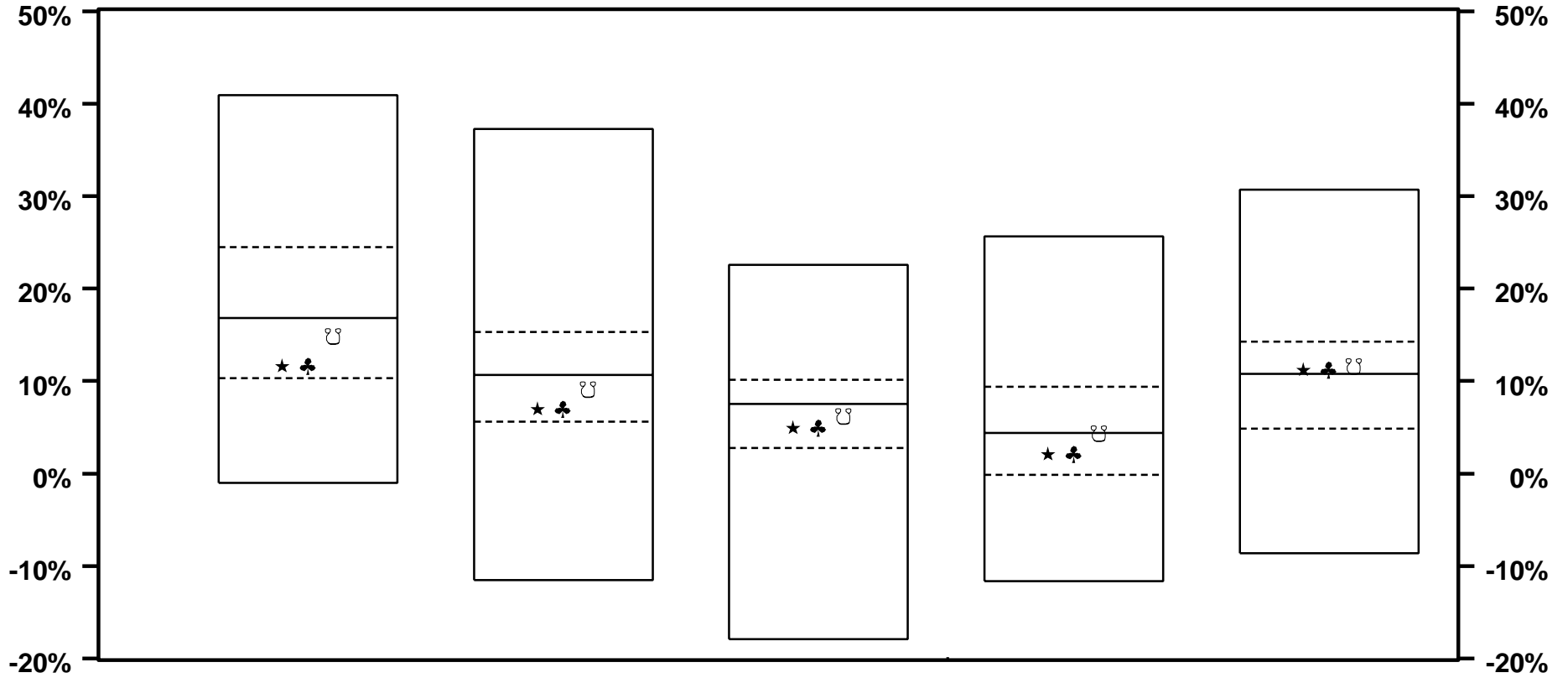

	6 / 05		6 / 04		6 / 03		6 / 02		6 / 01	
★ MUNI COMPOSITE	11.6	69	7.0	70	5.0	64	2.1	65	11.3	45
♣ SSR TOWER FUND	11.6	69	7.0	70	5.0	64	2.1	65	11.3	45
○ NCREIF CL PROP	14.9	60	9.1	57	6.2	56	4.3	50	11.6	44
MEDIAN	16.8		10.6		7.5		4.4		10.8	

VERMONT MUNICIPAL EMPLOYEES

REAL ESTATE ONLY - RATES OF RETURN

YEARS ENDING

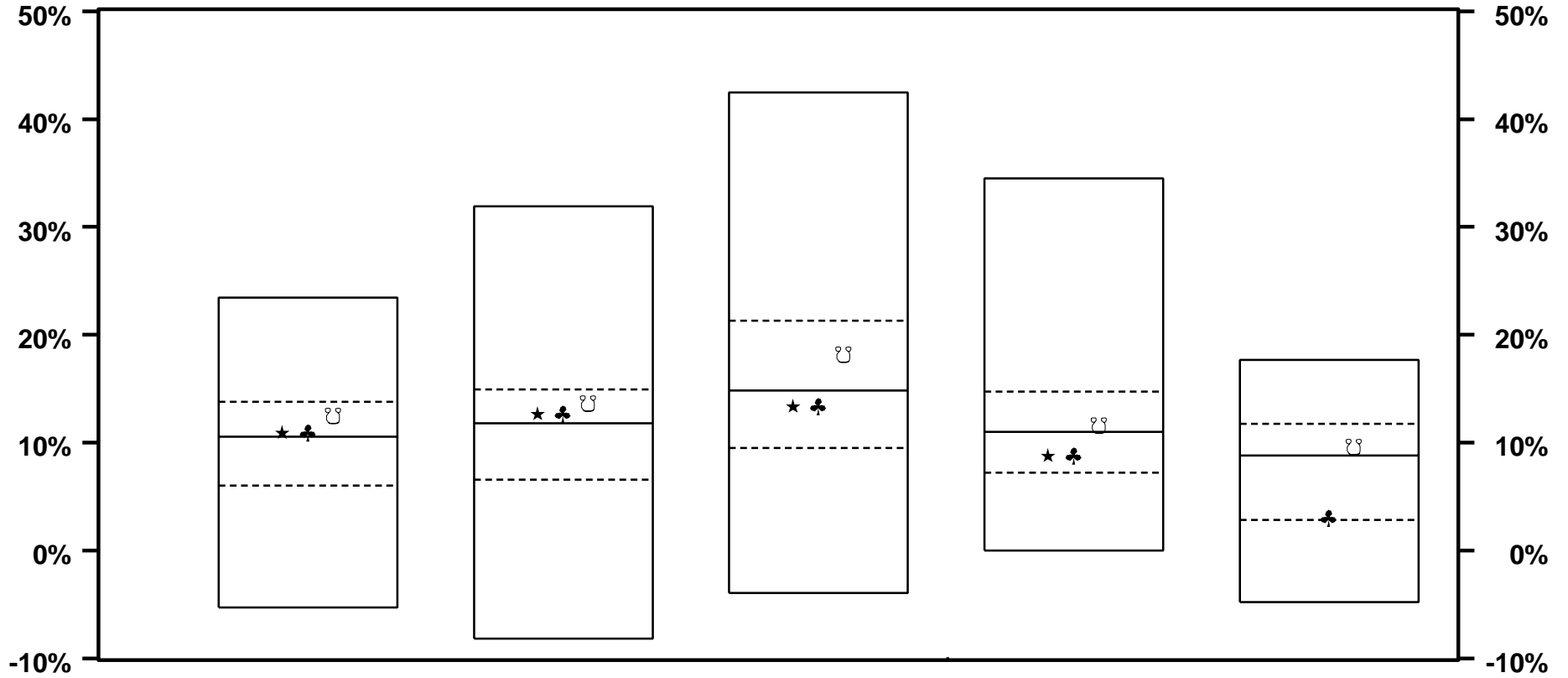

	6 / 00		6 / 99		6 / 98		6 / 97		6 / 96	
★ MUNI COMPOSITE	11.0	47	12.7	44	13.4	56	8.8	66		
♣ SSR TOWER FUND	11.0	47	12.7	44	13.4	56	8.8	66	3.1	74
⊖ NCREIF CL PROP	12.5	32	13.7	37	18.2	37	11.6	39	9.6	42
MEDIAN	10.6		11.8		14.8		11.0		8.8	

VERMONT MUNICIPAL EMPLOYEES

REIT - EQUITY ONLY RATES OF RETURN

PERIODS ENDING 6/05

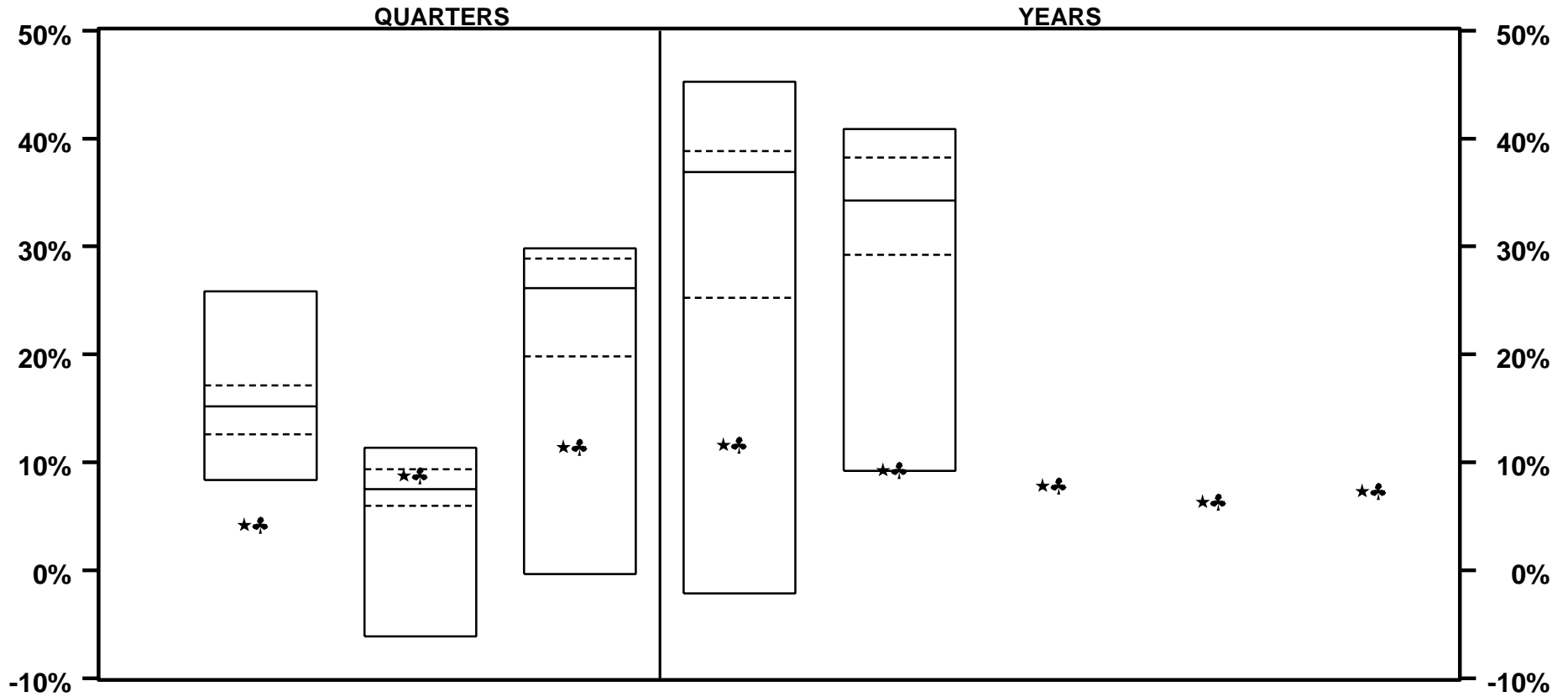

	LAST QTR		LAST 2 QTRS		LAST 3 QTRS		LAST YEAR		LAST 2 YEARS		LAST 3 YEARS	LAST 4 YEARS	LAST 5 YEARS
★ MUNI COMPOSITE	4.2	95	8.8	33	11.4	89	11.6	87	9.3	88	7.8	6.4	7.3
♣ SSR TOWER FUND	4.2	95	8.8	33	11.4	89	11.6	87	9.3	88	7.8	6.4	7.3
MEDIAN	15.2		7.5		26.2		36.9		34.3				

VERMONT MUNICIPAL EMPLOYEES

REIT - EQUITY ONLY RATES OF RETURN

PERIODS ENDING 6/05

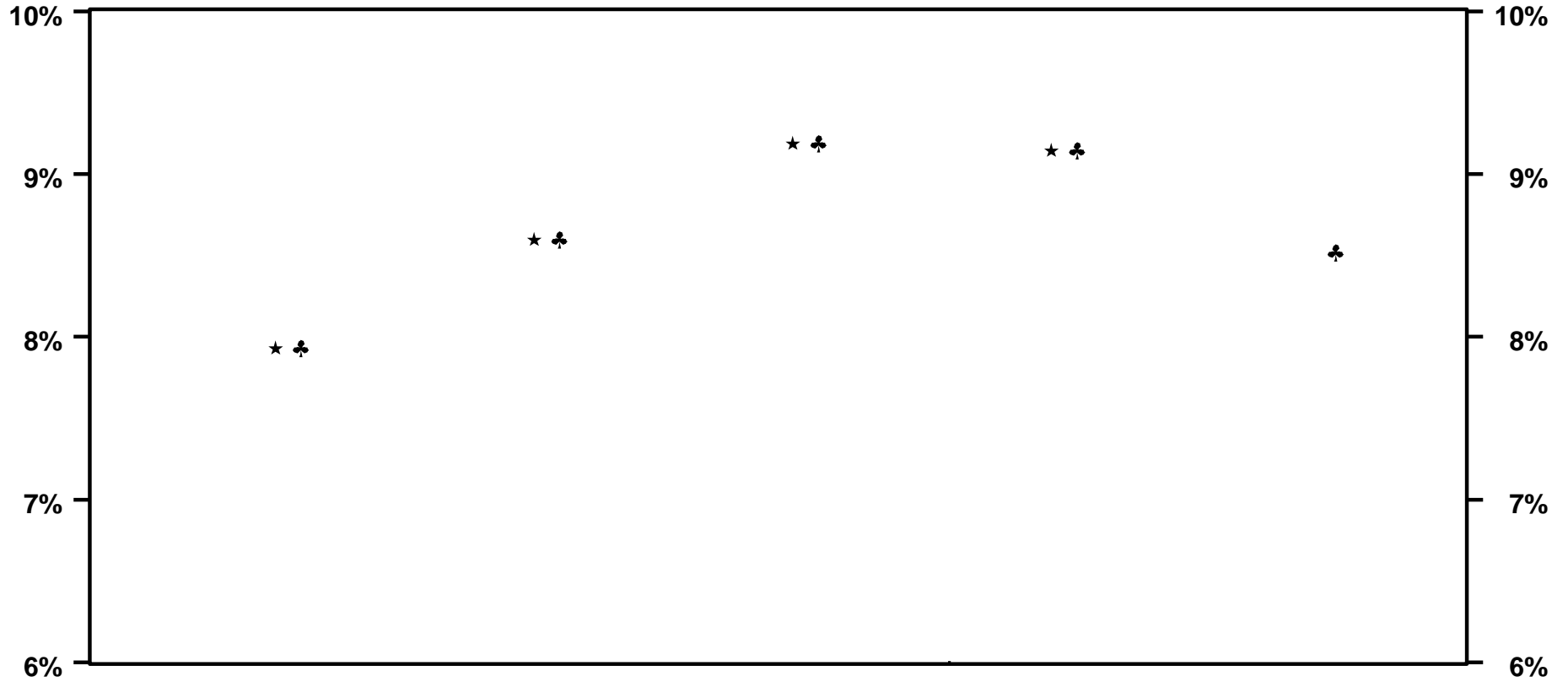

	<u>LAST 6 YEARS</u>	<u>LAST 7 YEARS</u>	<u>LAST 8 YEARS</u>	<u>LAST 9 YEARS</u>	<u>LAST 10 YEARS</u>
★ MUNI COMPOSITE	7.9	8.6	9.2	9.1	
♣ SSR TOWER FUND	7.9	8.6	9.2	9.1	8.5

MEDIAN

VERMONT MUNICIPAL EMPLOYEES

REIT - EQUITY ONLY RATES OF RETURN

YEARS ENDING

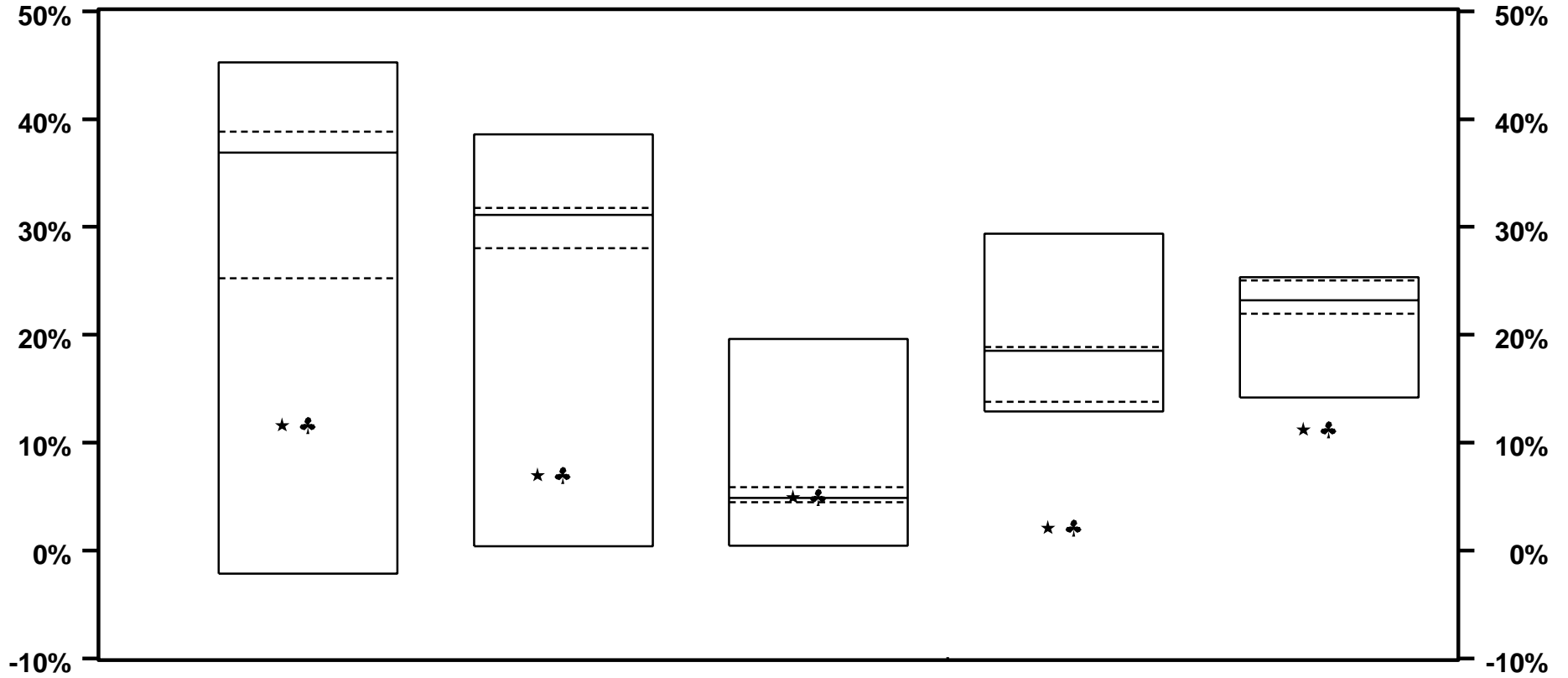

	6 / 05	6 / 04	6 / 03	6 / 02	6 / 01
★ MUNI COMPOSITE	11.6 87	7.0 93	5.0 48	2.1 95	11.3 95
♣ SSR TOWER FUND	11.6 87	7.0 93	5.0 48	2.1 95	11.3 95
MEDIAN	36.9	31.1	4.9	18.5	23.2

VERMONT MUNICIPAL EMPLOYEES

REIT - EQUITY ONLY RATES OF RETURN

YEARS ENDING

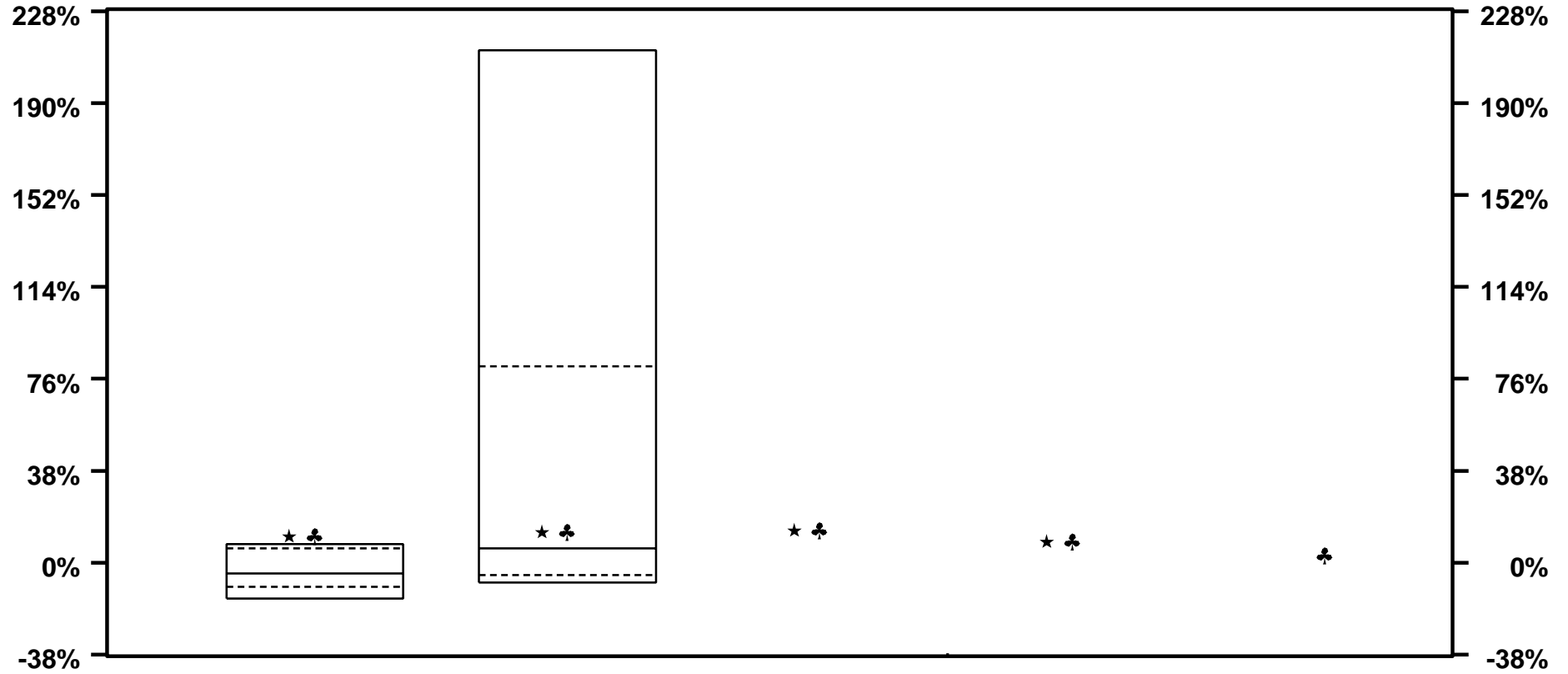

	<u>6 / 00</u>	<u>6 / 99</u>	<u>6 / 98</u>	<u>6 / 97</u>	<u>6 / 96</u>
★ MUNI COMPOSITE	11.0 5	12.7 46	13.4	8.8	
♣ SSR TOWER FUND	11.0 5	12.7 46	13.4	8.8	3.1
MEDIAN	- 4.4	6.0			

VERMONT MUNICIPAL EMPLOYEES
EQUITY ONLY SUMMARY STATISTICS
QUARTER ENDING 6/05

MUNICIPAL SYSTEM COMPOSITE

	<u>PORTFOLIO</u>	<u>S&P 500</u>
TOTAL NUMBER OF SECURITIES	246	
TOTAL MARKET VALUE \$	105,410,431	
AVERAGE MARKET CAPITALIZATION (000's)	60,081,000	88,599,700
MEDIAN MARKET CAPITALIZATION (000's)		10,839,500
EQUITY SEGMENT YIELD	1.28	1.83
EQUITY SEGMENT P/E	19.22	17.49
EQUITY SEGMENT BETA	1.14	1.00
PRICE/BOOK RATIO	3.90	3.51
FIVE YEAR EARNINGS GROWTH	14.45	11.16
RETURN ON EQUITY	17.84	19.26

TEN LARGEST HOLDINGS

TEN BEST PERFORMERS

TEN WORST PERFORMERS

<u>NAME</u>	<u>\$</u>	<u>WEIGHT</u>	<u>NAME</u>	<u>RETURN</u>	<u>NAME</u>	<u>RETURN</u>
GENERAL ELEC CO	2,724,952	2.6	GOOGLE INC	63.0	METROLOGIC INSTRS I	- 44.2
CITIGROUP INC	2,297,533	2.2	CORNING INC	49.3	TTM TECHNOLOGIES IN	- 27.2
GOOGLE INC	1,847,068	1.8	ALLIANCE GAMING COR	46.2	POLYONE CORPORATION	- 25.5
BANK OF AMERICA COR	1,693,864	1.6	LEGG MASON INC	33.5	SERENA SOFTWARE INC	- 18.8
YAHOO INC	1,687,301	1.6	ASSURED GUARANTY LT	30.3	LEARNING TREE INTER	- 17.4
PROCTER & GAMBLE CO	1,613,406	1.5	TITAN CORP COM	25.2	OLIN CORP COM	- 17.3
DELL INC	1,553,346	1.5	ALCON INC	23.7	INTERNATIONAL PAPER	- 17.3
PFIZER INC	1,541,722	1.5	PLEXUS CORP	23.6	BEARINGPOINT INC	- 16.4
MORGAN STANLEY DEAN	1,516,383	1.4	GILEAD SCIENCES INC	22.9	DU PONT E I DE NEMO	- 15.4
UNITEDHEALTH GROUP	1,338,738	1.3	ST JUDE MED INC COM	21.1	HANGER ORTHOPEDIC C	- 15.3

VERMONT MUNICIPAL EMPLOYEES
EQUITY ONLY SUMMARY STATISTICS
QUARTER ENDING 6/05

DOMESTIC EQUITY COMPOSITE

	<u>PORTFOLIO</u>	<u>S&P 500</u>
TOTAL NUMBER OF SECURITIES	246	
TOTAL MARKET VALUE \$	105,410,431	
AVERAGE MARKET CAPITALIZATION (000's)	60,081,000	88,599,700
MEDIAN MARKET CAPITALIZATION (000's)		10,839,500
EQUITY SEGMENT YIELD	1.28	1.83
EQUITY SEGMENT P/E	19.22	17.49
EQUITY SEGMENT BETA	1.14	1.00
PRICE/BOOK RATIO	3.90	3.51
FIVE YEAR EARNINGS GROWTH	14.45	11.16
RETURN ON EQUITY	17.84	19.26

TEN LARGEST HOLDINGS

TEN BEST PERFORMERS

TEN WORST PERFORMERS

<u>NAME</u>	<u>\$</u>	<u>WEIGHT</u>	<u>NAME</u>	<u>RETURN</u>	<u>NAME</u>	<u>RETURN</u>
GENERAL ELEC CO	2,724,952	2.6	GOOGLE INC	63.0	METROLOGIC INSTRS I	- 44.2
CITIGROUP INC	2,297,533	2.2	CORNING INC	49.3	TTM TECHNOLOGIES IN	- 27.2
GOOGLE INC	1,847,068	1.8	ALLIANCE GAMING COR	46.2	POLYONE CORPORATION	- 25.5
BANK OF AMERICA COR	1,693,864	1.6	LEGG MASON INC	33.5	SERENA SOFTWARE INC	- 18.8
YAHOO INC	1,687,301	1.6	ASSURED GUARANTY LT	30.3	LEARNING TREE INTER	- 17.4
PROCTER & GAMBLE CO	1,613,406	1.5	TITAN CORP COM	25.2	OLIN CORP COM	- 17.3
DELL INC	1,553,346	1.5	ALCON INC	23.7	INTERNATIONAL PAPER	- 17.3
PFIZER INC	1,541,722	1.5	PLEXUS CORP	23.6	BEARINGPOINT INC	- 16.4
MORGAN STANLEY DEAN	1,516,383	1.4	GILEAD SCIENCES INC	22.9	DU PONT E I DE NEMO	- 15.4
UNITEDHEALTH GROUP	1,338,738	1.3	ST JUDE MED INC COM	21.1	HANGER ORTHOPEDIC C	- 15.3

VERMONT MUNICIPAL EMPLOYEES
EQUITY ONLY SUMMARY STATISTICS
QUARTER ENDING 6/05

DELAWARE

	<u>PORTFOLIO</u>	<u>R 1000(R) VALUE</u>
TOTAL NUMBER OF SECURITIES	55	
TOTAL MARKET VALUE	\$ 40,726,386	
AVERAGE MARKET CAPITALIZATION (000's)	95,866,000	81,253,700
MEDIAN MARKET CAPITALIZATION (000's)	34,314,400	4,541,400
EQUITY SEGMENT YIELD	2.24	2.45
EQUITY SEGMENT P/E	15.99	14.79
EQUITY SEGMENT BETA	0.94	0.92
PRICE/BOOK RATIO	3.55	2.41
FIVE YEAR EARNINGS GROWTH	7.31	9.38
RETURN ON EQUITY	20.05	15.92

TEN LARGEST HOLDINGS

TEN BEST PERFORMERS

TEN WORST PERFORMERS

<u>NAME</u>	<u>\$</u>	<u>WEIGHT</u>	<u>NAME</u>	<u>RETURN</u>	<u>NAME</u>	<u>RETURN</u>
BANK OF AMERICA COR	1,693,864	4.2	CIGNA CORP COM USD1	19.9	INTERNATIONAL PAPER	- 17.3
CITIGROUP INC	1,645,788	4.0	MARATHON OIL CORP	14.5	DU PONT E I DE NEMO	- 15.4
PFIZER INC	1,541,722	3.8	PRUDENTIAL FINL INC	14.4	AVERY DENNISON CORP	- 13.9
MORGAN STANLEY DEAN	1,516,383	3.7	ALLTEL CORP	14.3	CLOROX CO COM	- 11.2
GENERAL ELEC CO	1,370,391	3.4	EXELON CORP	12.8	DOW CHEM CO	- 10.0
MERRILL LYNCH & CO	1,248,727	3.1	INTEL CORP	12.4	KNIGHT RIDDER INC	- 8.3
WYETH	1,085,800	2.7	GOODRICH CORP	7.5	MORGAN STANLEY DEAN	- 7.9
J P MORGAN CHASE &	1,059,459	2.6	MBNA CORP	7.2	VIACOM INC	- 7.9
US BANCORP DEL	999,903	2.5	NATIONAL SEMICONDC	7.0	GENERAL MILLS INC	- 4.2
ALLTEL CORP	996,294	2.4	CISCO SYS INC	6.7	BCE INC	- 4.2

VERMONT MUNICIPAL EMPLOYEES
EQUITY ONLY SUMMARY STATISTICS
QUARTER ENDING 6/05

ALLIANCE LARGE CAP GROWTH FUND

	PORTFOLIO	R 1000(R) GR
TOTAL NUMBER OF SECURITIES	52	
TOTAL MARKET VALUE	\$ 39,347,323	
AVERAGE MARKET CAPITALIZATION (000's)	60,935,700	75,941,300
MEDIAN MARKET CAPITALIZATION (000's)	23,891,400	4,631,600
EQUITY SEGMENT YIELD	0.59	1.09
EQUITY SEGMENT P/E	26.58	21.93
EQUITY SEGMENT BETA	1.24	1.11
PRICE/BOOK RATIO	5.22	4.71
FIVE YEAR EARNINGS GROWTH	25.60	13.84
RETURN ON EQUITY	19.48	21.69

TEN LARGEST HOLDINGS

TEN BEST PERFORMERS

TEN WORST PERFORMERS

<u>NAME</u>	<u>\$</u>	<u>WEIGHT</u>	<u>NAME</u>	<u>RETURN</u>	<u>NAME</u>	<u>RETURN</u>
GOOGLE INC	1,847,068	4.7	GOOGLE INC	63.0	APPLE COMPUTER INC	- 11.7
YAHOO INC	1,687,301	4.3	CORNING INC	49.3	AVON PRODS INC	- 11.5
DELL INC	1,553,346	3.9	LEGG MASON INC	33.5	EBAY INC	- 11.4
GENERAL ELEC CO	1,354,561	3.4	ALCON INC	23.7	QUALCOMM INC	- 9.7
UNITEDHEALTH GROUP	1,338,738	3.4	GILEAD SCIENCES INC	22.9	UNITED PARCEL SVC I	- 4.5
ELECTRONIC ARTS INC	1,210,615	3.1	ST JUDE MED INC COM	21.1	GENERAL ELEC CO	- 3.3
EBAY INC	1,193,777	3.0	BROADCOM CORP	18.7	ZIMMER HLDGS INC	- 2.1
LOWES COS INC	1,193,499	3.0	AFLAC INC	16.5	MARVELL TECHNOLOGY	- 1.0
ALCON INC	1,154,339	2.9	WHOLE FOODS MKT INC	16.0	STARBUCKS CORP	0.0
ST JUDE MED INC COM	1,128,634	2.9	BAKER HUGHES INC	15.3	PROCTER & GAMBLE CO	0.1

VERMONT MUNICIPAL EMPLOYEES
EQUITY ONLY SUMMARY STATISTICS
QUARTER ENDING 6/05

LAZARD SMALL CAP FUND

	PORTFOLIO	R 2000(R)
TOTAL NUMBER OF SECURITIES	142	
TOTAL MARKET VALUE	\$ 25,336,722	
AVERAGE MARKET CAPITALIZATION (000's)	1,232,600	986,500
MEDIAN MARKET CAPITALIZATION (000's)	1,070,900	564,900
EQUITY SEGMENT YIELD	0.80	1.12
EQUITY SEGMENT P/E	17.46	17.03
EQUITY SEGMENT BETA	1.31	1.23
PRICE/BOOK RATIO	2.64	2.99
FIVE YEAR EARNINGS GROWTH	9.26	9.09
RETURN ON EQUITY	11.77	11.04

TEN LARGEST HOLDINGS

TEN BEST PERFORMERS

TEN WORST PERFORMERS

NAME	\$	WEIGHT	NAME	RETURN	NAME	RETURN
KEY ENERGY GROUP IN	448,522	1.8	ALLIANCE GAMING COR	46.2	METROLOGIC INSTRS I	- 44.2
ARCH CAPITAL GROUP	312,271	1.2	ASSURED GUARANTY LT	30.3	TTM TECHNOLOGIES IN	- 27.2
ADVO INC	311,334	1.2	TITAN CORP COM	25.2	POLYONE CORPORATION	- 25.5
VERITAS DOC INC	310,819	1.2	PLEXUS CORP	23.6	SERENA SOFTWARE INC	- 18.8
ASSURED GUARANTY LT	305,142	1.2	DRS TECHNOLOGIES IN	20.7	LEARNING TREE INTER	- 17.4
KINDER MORGAN MGMT	294,924	1.2	BRISTOL WEST HLDGS	18.6	OLIN CORP COM	- 17.3
PSS WORLD MED INC	293,297	1.2	AMIS HLDGS INC	18.2	BEARINGPOINT INC	- 16.4
SCOTTS MIRACLE GRO	283,693	1.1	CAPITAL AUTOMOTIVE	16.7	HANGER ORTHOPEDIC C	- 15.3
AGL RES INC	283,120	1.1	COMMSCOPE INC	16.4	ADVO INC	- 14.7
ALLIANCE GAMING COR	278,596	1.1	CARRAMERICA REALTY	16.4	RUSH ENTERPRISES IN	- 14.5

VERMONT MUNICIPAL EMPLOYEES
DOMESTIC EQUITY ONLY SUMMARY STATISTICS
QUARTER ENDING 6/05

MUNICIPAL SYSTEM COMPOSITE

	<u>PORTFOLIO</u>	<u>S&P 500</u>
TOTAL NUMBER OF SECURITIES	246	
TOTAL MARKET VALUE \$	105,410,431	
AVERAGE MARKET CAPITALIZATION (000's)	61,083,500	89,311,300
MEDIAN MARKET CAPITALIZATION (000's)		10,839,500
EQUITY SEGMENT YIELD	1.30	1.83
EQUITY SEGMENT P/E	19.22	17.43
EQUITY SEGMENT BETA	1.13	1.00
PRICE/BOOK RATIO	3.93	3.50
FIVE YEAR EARNINGS GROWTH	14.44	11.26
RETURN ON EQUITY	17.92	19.31

TEN LARGEST HOLDINGS

TEN BEST PERFORMERS

TEN WORST PERFORMERS

<u>NAME</u>	<u>\$</u>	<u>WEIGHT</u>	<u>NAME</u>	<u>RETURN</u>	<u>NAME</u>	<u>RETURN</u>
GENERAL ELEC CO	2,724,952	2.6	GOOGLE INC	63.0	METROLOGIC INSTRS I	- 44.2
CITIGROUP INC	2,297,533	2.2	CORNING INC	49.3	TTM TECHNOLOGIES IN	- 27.2
GOOGLE INC	1,847,068	1.8	ALLIANCE GAMING COR	46.2	POLYONE CORPORATION	- 25.5
BANK OF AMERICA COR	1,693,864	1.6	LEGG MASON INC	33.5	SERENA SOFTWARE INC	- 18.8
YAHOO INC	1,687,301	1.6	ASSURED GUARANTY LT	30.3	LEARNING TREE INTER	- 17.4
PROCTER & GAMBLE CO	1,613,406	1.5	TITAN CORP COM	25.2	OLIN CORP COM	- 17.3
DELL INC	1,553,346	1.5	ALCON INC	23.7	INTERNATIONAL PAPER	- 17.3
PFIZER INC	1,541,722	1.5	PLEXUS CORP	23.6	BEARINGPOINT INC	- 16.4
MORGAN STANLEY DEAN	1,516,383	1.4	GILEAD SCIENCES INC	22.9	DU PONT E I DE NEMO	- 15.4
UNITEDHEALTH GROUP	1,338,738	1.3	ST JUDE MED INC COM	21.1	HANGER ORTHOPEDIC C	- 15.3

VERMONT MUNICIPAL EMPLOYEES
DOMESTIC EQUITY ONLY SUMMARY STATISTICS
QUARTER ENDING 6/05

DOMESTIC EQUITY COMPOSITE

	<u>PORTFOLIO</u>	<u>S&P 500</u>
TOTAL NUMBER OF SECURITIES	246	
TOTAL MARKET VALUE \$	105,410,431	
AVERAGE MARKET CAPITALIZATION (000's)	61,083,500	89,311,300
MEDIAN MARKET CAPITALIZATION (000's)		10,839,500
EQUITY SEGMENT YIELD	1.30	1.83
EQUITY SEGMENT P/E	19.22	17.43
EQUITY SEGMENT BETA	1.13	1.00
PRICE/BOOK RATIO	3.93	3.50
FIVE YEAR EARNINGS GROWTH	14.44	11.26
RETURN ON EQUITY	17.92	19.31

TEN LARGEST HOLDINGS

TEN BEST PERFORMERS

TEN WORST PERFORMERS

<u>NAME</u>	<u>\$</u>	<u>WEIGHT</u>	<u>NAME</u>	<u>RETURN</u>	<u>NAME</u>	<u>RETURN</u>
GENERAL ELEC CO	2,724,952	2.6	GOOGLE INC	63.0	METROLOGIC INSTRS I	- 44.2
CITIGROUP INC	2,297,533	2.2	CORNING INC	49.3	TTM TECHNOLOGIES IN	- 27.2
GOOGLE INC	1,847,068	1.8	ALLIANCE GAMING COR	46.2	POLYONE CORPORATION	- 25.5
BANK OF AMERICA COR	1,693,864	1.6	LEGG MASON INC	33.5	SERENA SOFTWARE INC	- 18.8
YAHOO INC	1,687,301	1.6	ASSURED GUARANTY LT	30.3	LEARNING TREE INTER	- 17.4
PROCTER & GAMBLE CO	1,613,406	1.5	TITAN CORP COM	25.2	OLIN CORP COM	- 17.3
DELL INC	1,553,346	1.5	ALCON INC	23.7	INTERNATIONAL PAPER	- 17.3
PFIZER INC	1,541,722	1.5	PLEXUS CORP	23.6	BEARINGPOINT INC	- 16.4
MORGAN STANLEY DEAN	1,516,383	1.4	GILEAD SCIENCES INC	22.9	DU PONT E I DE NEMO	- 15.4
UNITEDHEALTH GROUP	1,338,738	1.3	ST JUDE MED INC COM	21.1	HANGER ORTHOPEDIC C	- 15.3

VERMONT MUNICIPAL EMPLOYEES
DOMESTIC EQUITY ONLY SUMMARY STATISTICS
QUARTER ENDING 6/05

DELAWARE

	<u>PORTFOLIO</u>	<u>R 1000(R) VALUE</u>
TOTAL NUMBER OF SECURITIES	55	
TOTAL MARKET VALUE	\$ 40,726,386	
AVERAGE MARKET CAPITALIZATION (000's)	95,866,000	81,355,200
MEDIAN MARKET CAPITALIZATION (000's)	34,314,400	4,541,400
EQUITY SEGMENT YIELD	2.24	2.46
EQUITY SEGMENT P/E	15.99	14.78
EQUITY SEGMENT BETA	0.94	0.92
PRICE/BOOK RATIO	3.55	2.41
FIVE YEAR EARNINGS GROWTH	7.31	9.38
RETURN ON EQUITY	20.05	15.92

TEN LARGEST HOLDINGS

TEN BEST PERFORMERS

TEN WORST PERFORMERS

<u>NAME</u>	<u>\$</u>	<u>WEIGHT</u>	<u>NAME</u>	<u>RETURN</u>	<u>NAME</u>	<u>RETURN</u>
BANK OF AMERICA COR	1,693,864	4.2	CIGNA CORP COM USD1	19.9	INTERNATIONAL PAPER	- 17.3
CITIGROUP INC	1,645,788	4.0	MARATHON OIL CORP	14.5	DU PONT E I DE NEMO	- 15.4
PFIZER INC	1,541,722	3.8	PRUDENTIAL FINL INC	14.4	AVERY DENNISON CORP	- 13.9
MORGAN STANLEY DEAN	1,516,383	3.7	ALLTEL CORP	14.3	CLOROX CO COM	- 11.2
GENERAL ELEC CO	1,370,391	3.4	EXELON CORP	12.8	DOW CHEM CO	- 10.0
MERRILL LYNCH & CO	1,248,727	3.1	INTEL CORP	12.4	KNIGHT RIDDER INC	- 8.3
WYETH	1,085,800	2.7	GOODRICH CORP	7.5	MORGAN STANLEY DEAN	- 7.9
J P MORGAN CHASE &	1,059,459	2.6	MBNA CORP	7.2	VIACOM INC	- 7.9
US BANCORP DEL	999,903	2.5	NATIONAL SEMICONDC	7.0	GENERAL MILLS INC	- 4.2
ALLTEL CORP	996,294	2.4	CISCO SYS INC	6.7	BCE INC	- 4.2

VERMONT MUNICIPAL EMPLOYEES
DOMESTIC EQUITY ONLY SUMMARY STATISTICS
QUARTER ENDING 6/05

ALLIANCE LARGE CAP GROWTH FUND

	PORTFOLIO	R 1000(R) GR
TOTAL NUMBER OF SECURITIES	52	
TOTAL MARKET VALUE	\$ 39,347,323	
AVERAGE MARKET CAPITALIZATION (000's)	62,076,500	75,981,700
MEDIAN MARKET CAPITALIZATION (000's)	23,891,400	4,631,600
EQUITY SEGMENT YIELD	0.60	1.09
EQUITY SEGMENT P/E	26.58	21.94
EQUITY SEGMENT BETA	1.22	1.11
PRICE/BOOK RATIO	5.27	4.71
FIVE YEAR EARNINGS GROWTH	25.89	13.82
RETURN ON EQUITY	19.78	21.69

TEN LARGEST HOLDINGS

TEN BEST PERFORMERS

TEN WORST PERFORMERS

<u>NAME</u>	<u>\$</u>	<u>WEIGHT</u>	<u>NAME</u>	<u>RETURN</u>	<u>NAME</u>	<u>RETURN</u>
GOOGLE INC	1,847,068	4.7	GOOGLE INC	63.0	APPLE COMPUTER INC	- 11.7
YAHOO INC	1,687,301	4.3	CORNING INC	49.3	AVON PRODS INC	- 11.5
DELL INC	1,553,346	3.9	LEGG MASON INC	33.5	EBAY INC	- 11.4
GENERAL ELEC CO	1,354,561	3.4	ALCON INC	23.7	QUALCOMM INC	- 9.7
UNITEDHEALTH GROUP	1,338,738	3.4	GILEAD SCIENCES INC	22.9	UNITED PARCEL SVC I	- 4.5
ELECTRONIC ARTS INC	1,210,615	3.1	ST JUDE MED INC COM	21.1	GENERAL ELEC CO	- 3.3
EBAY INC	1,193,777	3.0	BROADCOM CORP	18.7	ZIMMER HLDGS INC	- 2.1
LOWES COS INC	1,193,499	3.0	AFLAC INC	16.5	MARVELL TECHNOLOGY	- 1.0
ALCON INC	1,154,339	2.9	WHOLE FOODS MKT INC	16.0	STARBUCKS CORP	0.0
ST JUDE MED INC COM	1,128,634	2.9	BAKER HUGHES INC	15.3	PROCTER & GAMBLE CO	0.1

VERMONT MUNICIPAL EMPLOYEES
DOMESTIC EQUITY ONLY SUMMARY STATISTICS
QUARTER ENDING 6/05

LAZARD SMALL CAP FUND

	PORTFOLIO	R 2000(R)
TOTAL NUMBER OF SECURITIES	142	
TOTAL MARKET VALUE	\$ 25,336,722	
AVERAGE MARKET CAPITALIZATION (000's)	1,215,300	985,300
MEDIAN MARKET CAPITALIZATION (000's)	1,055,000	564,600
EQUITY SEGMENT YIELD	0.82	1.12
EQUITY SEGMENT P/E	17.46	17.03
EQUITY SEGMENT BETA	1.33	1.23
PRICE/BOOK RATIO	2.69	2.98
FIVE YEAR EARNINGS GROWTH	8.82	9.06
RETURN ON EQUITY	11.44	11.04

TEN LARGEST HOLDINGS

TEN BEST PERFORMERS

TEN WORST PERFORMERS

NAME	\$	WEIGHT	NAME	RETURN	NAME	RETURN
KEY ENERGY GROUP IN	448,522	1.8	ALLIANCE GAMING COR	46.2	METROLOGIC INSTRS I	- 44.2
ARCH CAPITAL GROUP	312,271	1.2	ASSURED GUARANTY LT	30.3	TTM TECHNOLOGIES IN	- 27.2
ADVO INC	311,334	1.2	TITAN CORP COM	25.2	POLYONE CORPORATION	- 25.5
VERITAS DOC INC	310,819	1.2	PLEXUS CORP	23.6	SERENA SOFTWARE INC	- 18.8
ASSURED GUARANTY LT	305,142	1.2	DRS TECHNOLOGIES IN	20.7	LEARNING TREE INTER	- 17.4
KINDER MORGAN MGMT	294,924	1.2	BRISTOL WEST HLDGS	18.6	OLIN CORP COM	- 17.3
PSS WORLD MED INC	293,297	1.2	AMIS HLDGS INC	18.2	BEARINGPOINT INC	- 16.4
SCOTTS MIRACLE GRO	283,693	1.1	CAPITAL AUTOMOTIVE	16.7	HANGER ORTHOPEDIC C	- 15.3
AGL RES INC	283,120	1.1	COMMSCOPE INC	16.4	ADVO INC	- 14.7
ALLIANCE GAMING COR	278,596	1.1	CARRAMERICA REALTY	16.4	RUSH ENTERPRISES IN	- 14.5

VERMONT MUNICIPAL EMPLOYEES

EQUITY FUNDS ONLY - CAPITAL MARKET LINE

3 YEARS ENDING 6/05

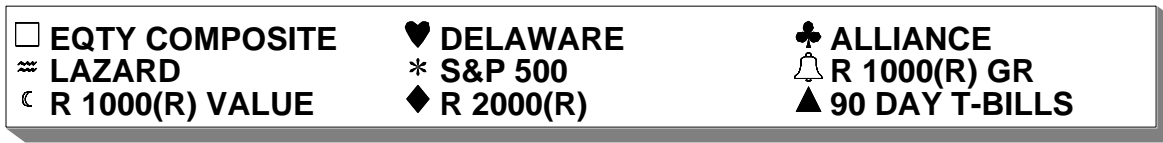
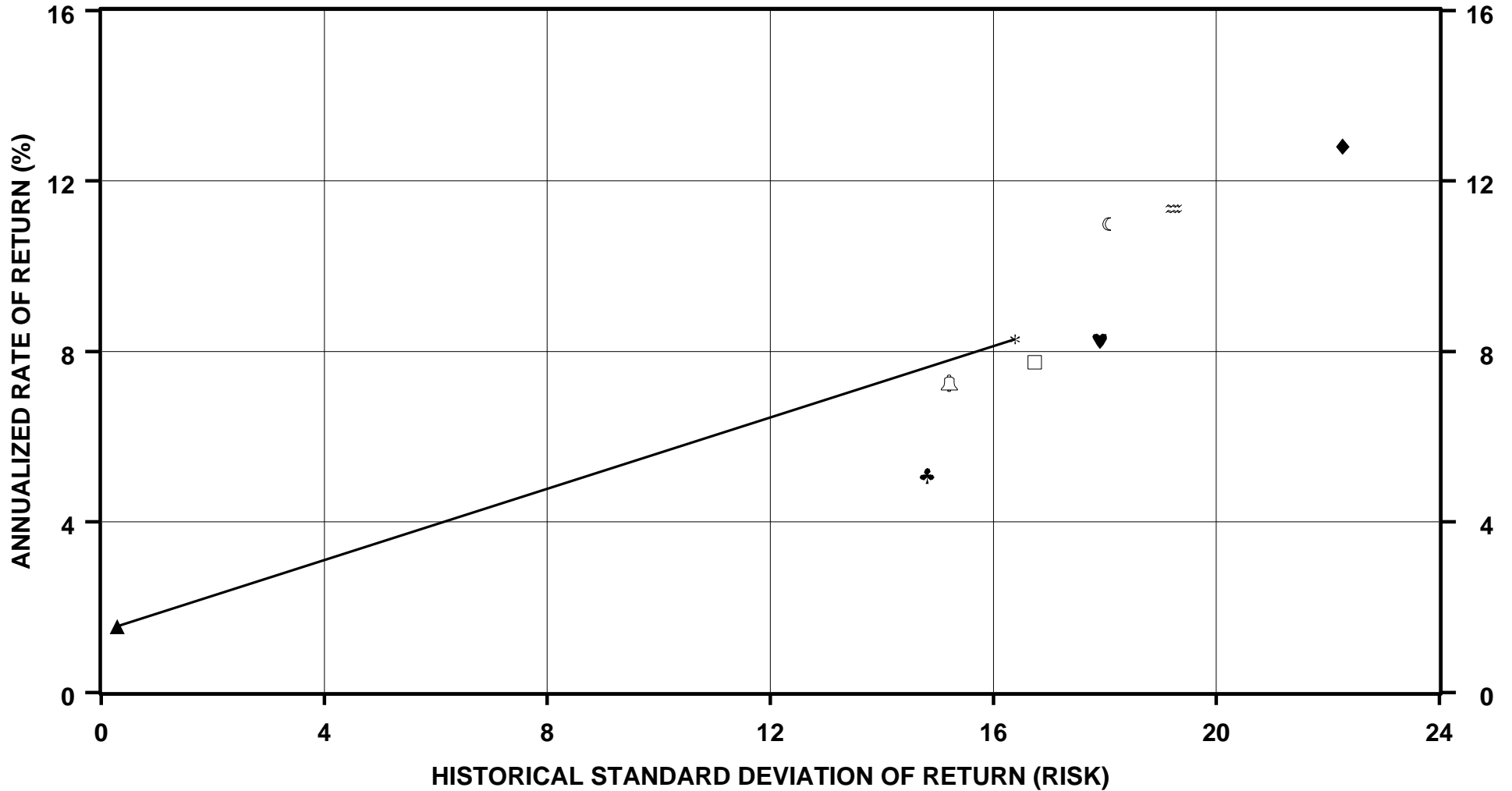

VERMONT MUNICIPAL EMPLOYEES

EQUITY FUNDS ONLY - CAPITAL MARKET LINE

5 YEARS ENDING 6/05

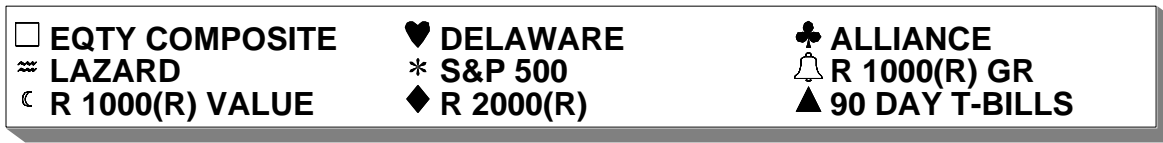
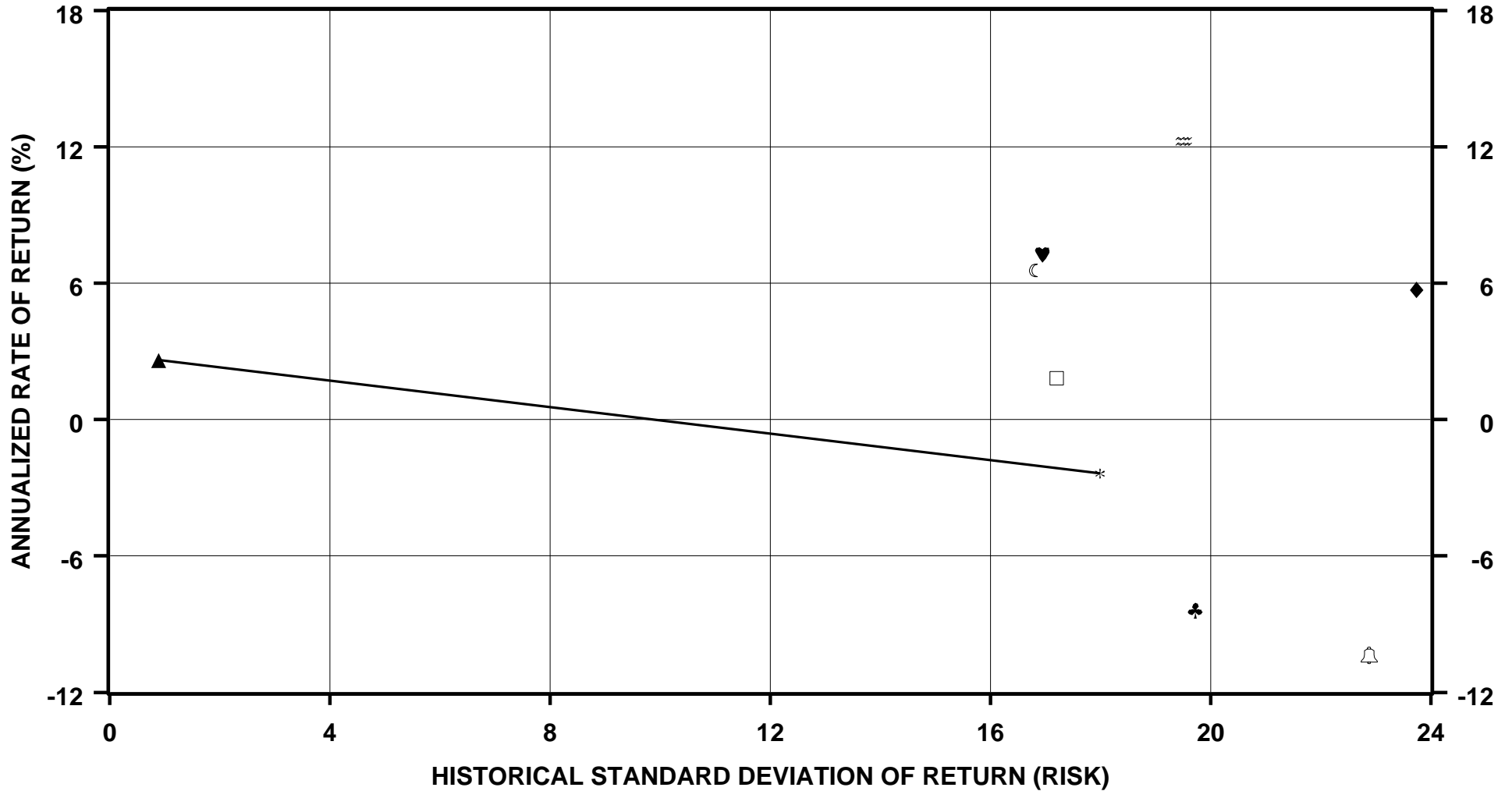

VERMONT MUNICIPAL EMPLOYEES

EQUITY PORTFOLIO CHARACTERISTICS

PERIODS ENDING 6/05

DIVIDEND YIELD

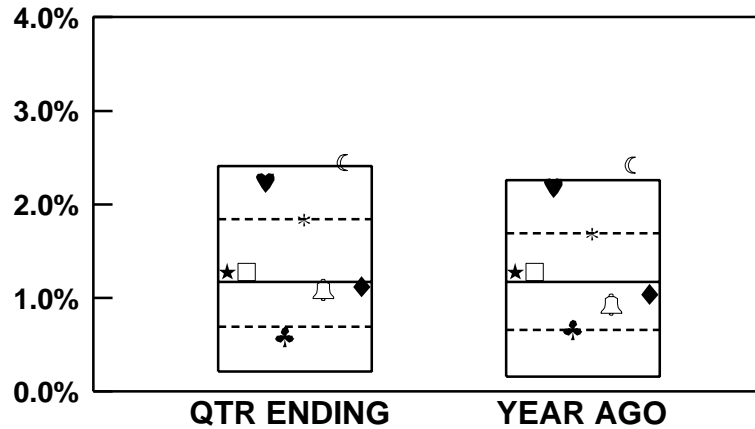

CAPITALIZATION

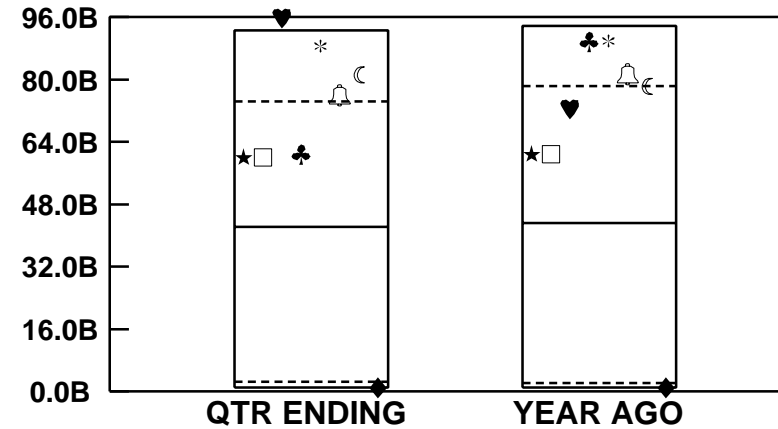

EFFECTS ON RETURN

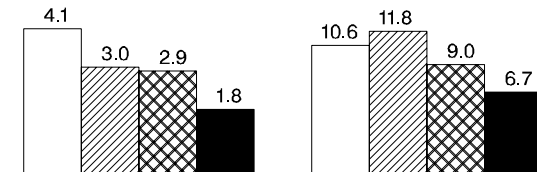
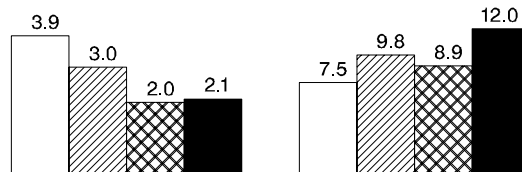
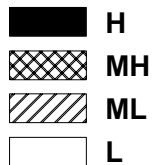

★ MUNI COMPOSITE	1.28	45	1.28	44	60.08	36	60.95	38
□ EQTY COMPOSITE	1.28	45	1.28	44	60.08	36	60.96	38
♥ DELAWARE	2.24	8	2.18	7	95.87	3	72.48	30
♣ ALLIANCE	0.59	78	0.66	74	60.94	35	89.87	7
* S&P 500	1.83	27	1.68	28	88.60	13	89.92	7
🔔 R 1000(R) GR	1.09	54	0.93	60	75.94	23	81.44	21
☾ R 1000(R) VALUE	2.45	4	2.42	2	81.25	18	78.36	24
◆ R 2000(R)	1.12	52	1.04	55	0.99	96	0.90	96
MEDIAN	1.17		1.17		42.17		43.15	

VERMONT MUNICIPAL EMPLOYEES

EQUITY PORTFOLIO CHARACTERISTICS

PERIODS ENDING 6/05

DIVIDEND YIELD

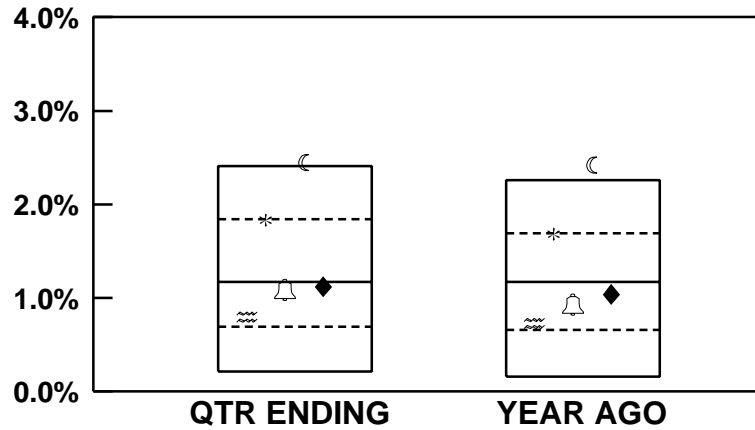

CAPITALIZATION

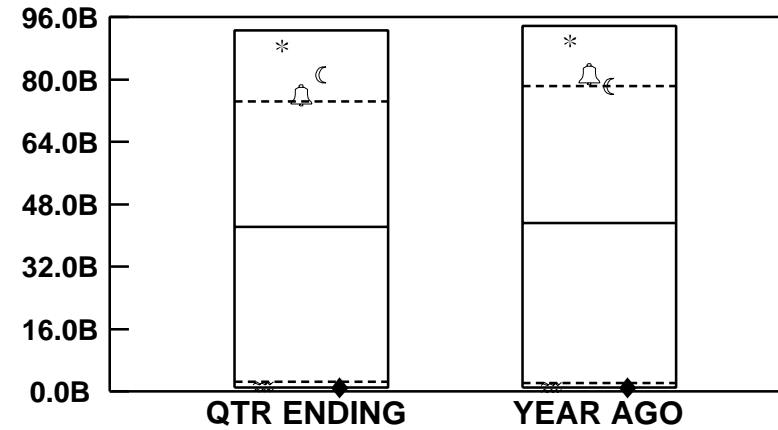

EFFECTS ON RETURN

- H
- MH
- ML
- L

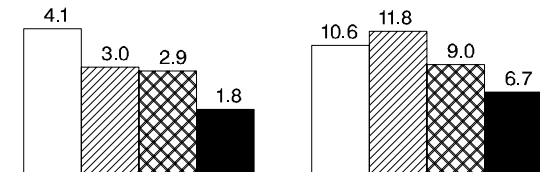
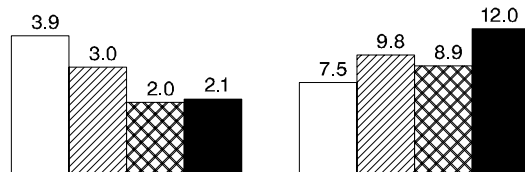

≈ LAZARD	0.80	67	0.73	71	1.23	89	1.17	89
* S&P 500	1.83	27	1.68	28	88.60	13	89.92	7
🔔 R 1000(R) GR	1.09	54	0.93	60	75.94	23	81.44	21
☾ R 1000(R) VALUE	2.45	4	2.42	2	81.25	18	78.36	24
◆ R 2000(R)	1.12	52	1.04	55	0.99	96	0.90	96
MEDIAN	1.17		1.17		42.17		43.15	

VERMONT MUNICIPAL EMPLOYEES

EQUITY PORTFOLIO CHARACTERISTICS

PERIODS ENDING 6/05

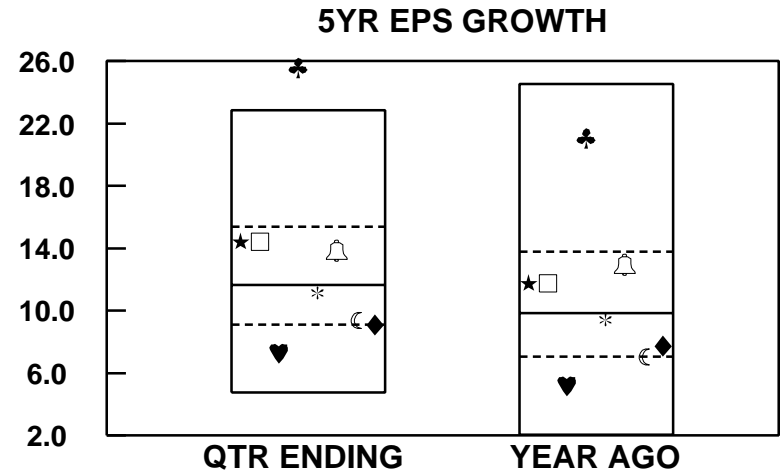
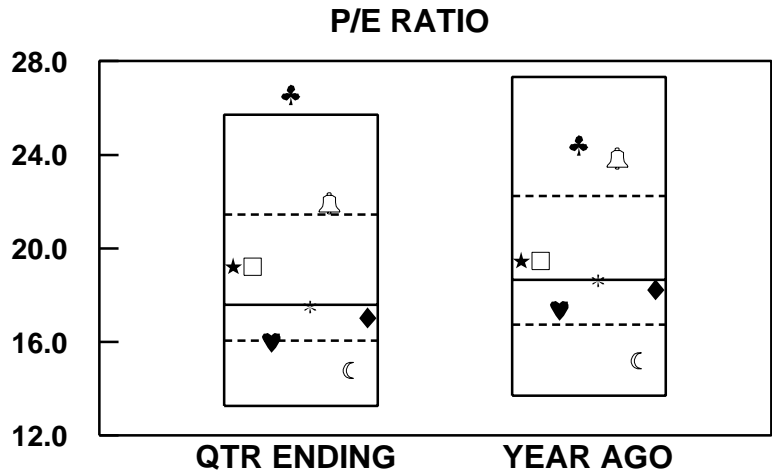

EFFECTS ON RETURN

- H
- MH
- ML
- L

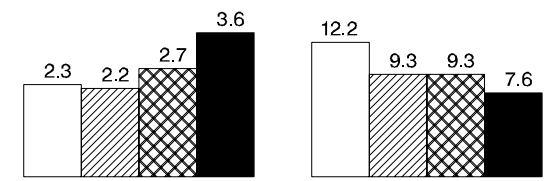
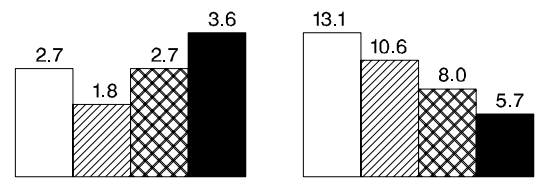

★ MUNI COMPOSITE	19.22	34	19.46	41	14.45	29	11.77	36
□ EQTY COMPOSITE	19.22	34	19.46	41	14.45	29	11.77	36
♥ DELAWARE	15.99	75	17.37	67	7.31	86	5.18	83
♣ ALLIANCE	26.58	3	24.43	14	25.60	2	21.07	8
* S&P 500	17.49	51	18.62	55	11.16	54	9.42	59
🔔 R 1000(R) GR	21.93	21	23.84	16	13.84	33	12.96	29
☾ R 1000(R) VALUE	14.79	84	15.19	86	9.38	72	7.03	75
◆ R 2000(R)	17.03	61	18.23	60	9.09	74	7.75	72
MEDIAN	17.59		18.66		11.63		9.85	

VERMONT MUNICIPAL EMPLOYEES

EQUITY PORTFOLIO CHARACTERISTICS

PERIODS ENDING 6/05

P/E RATIO

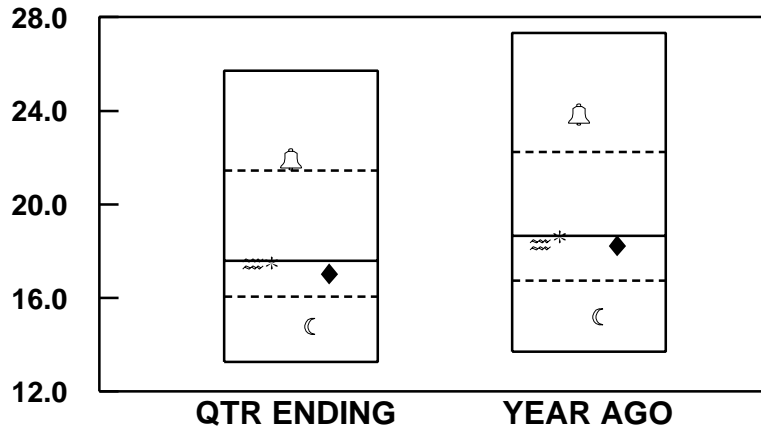

5YR EPS GROWTH

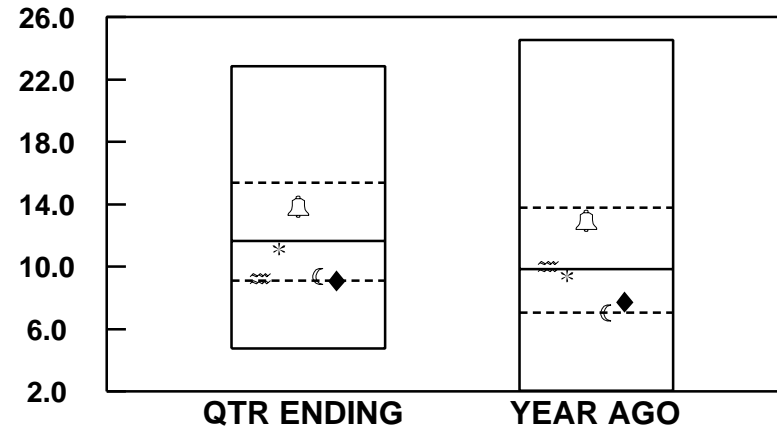

EFFECTS ON RETURN

- H
- MH
- ML
- L

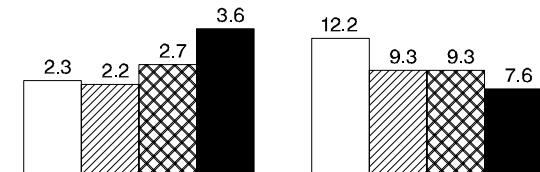
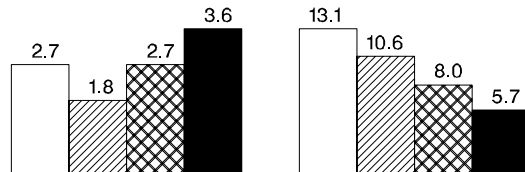

≈ LAZARD	17.46	51	18.27	59	9.26	73	10.01	48
* S&P 500	17.49	51	18.62	55	11.16	54	9.42	59
🔔 R 1000(R) GR	21.93	21	23.84	16	13.84	33	12.96	29
☾ R 1000(R) VALUE	14.79	84	15.19	86	9.38	72	7.03	75
◆ R 2000(R)	17.03	61	18.23	60	9.09	74	7.75	72
MEDIAN	17.59		18.66		11.63		9.85	

VERMONT MUNICIPAL EMPLOYEES

EQUITY PORTFOLIO CHARACTERISTICS

PERIODS ENDING 6/05

RETURN ON EQUITY

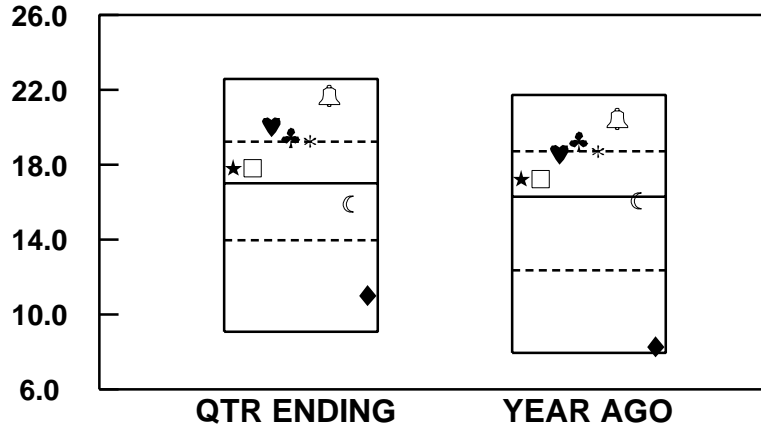

PRICE/BOOK

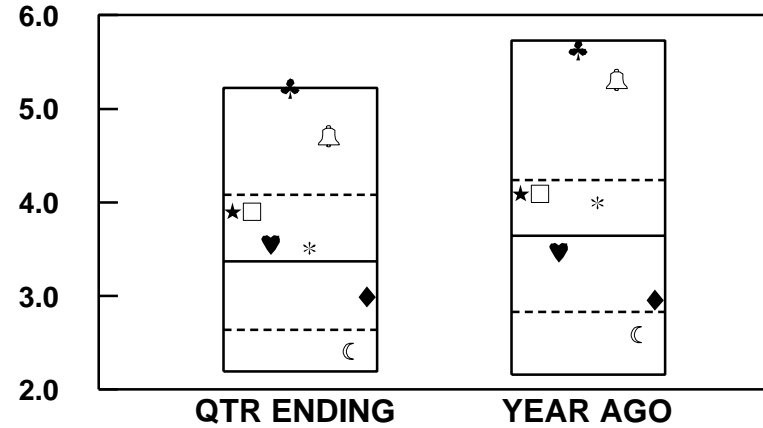

EFFECTS ON RETURN

- H
- MH
- ML
- L

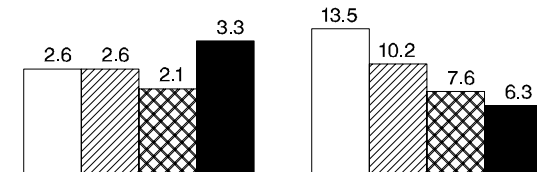
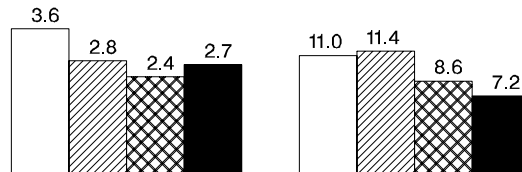

★ MUNI COMPOSITE	17.84	43	17.25	43		3.90	28	4.09	27
□ EQTY COMPOSITE	17.84	43	17.25	43		3.90	28	4.09	27
♥ DELAWARE	20.05	16	18.60	29		3.55	36	3.47	53
♣ ALLIANCE	19.48	21	19.27	16		5.22	5	5.63	6
* S&P 500	19.26	24	18.71	26		3.51	38	4.00	30
🔔 R 1000(R) GR	21.69	8	20.48	8		4.71	11	5.31	9
☾ R 1000(R) VALUE	15.92	58	16.07	52		2.41	87	2.59	82
◆ R 2000(R)	11.04	89	8.28	93		2.99	61	2.96	68
MEDIAN	17.03		16.31			3.37		3.64	

VERMONT MUNICIPAL EMPLOYEES

EQUITY PORTFOLIO CHARACTERISTICS

PERIODS ENDING 6/05

RETURN ON EQUITY

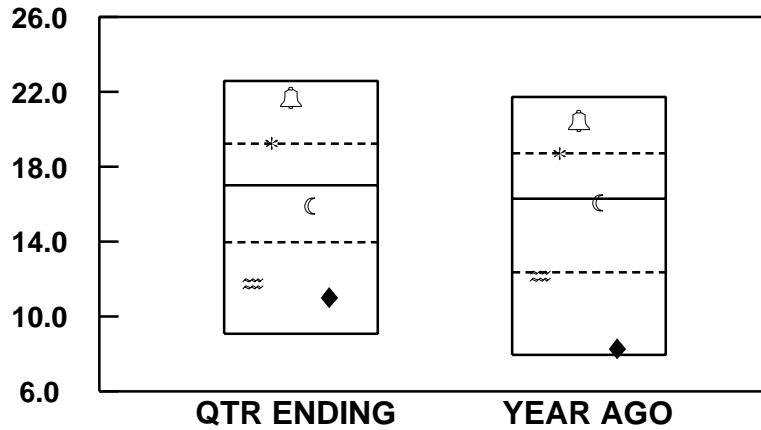

PRICE/BOOK

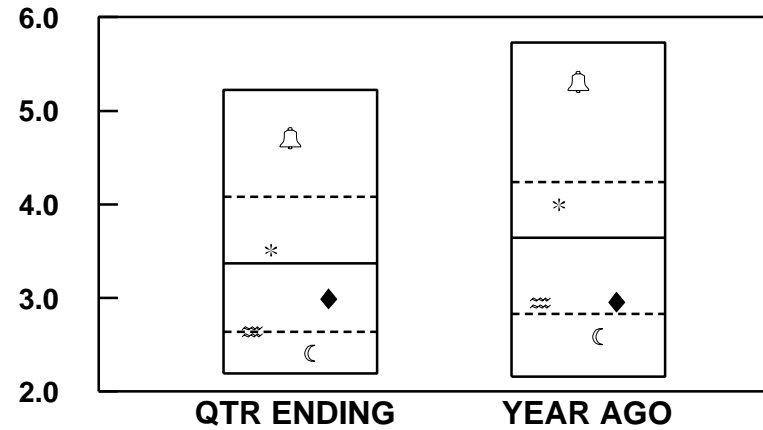

EFFECTS ON RETURN

- H
- MH
- ML
- L

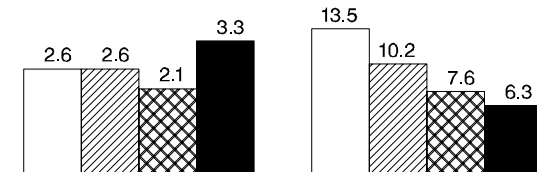
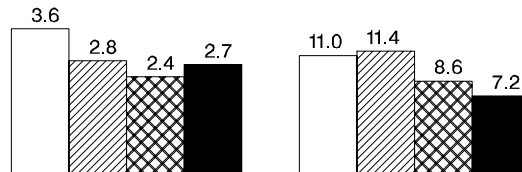

≈ LAZARD	11.77	86	12.18	79	2.64	75	2.95	69
* S&P 500	19.26	24	18.71	26	3.51	38	4.00	30
🔔 R 1000(R) GR	21.69	8	20.48	8	4.71	11	5.31	9
☾ R 1000(R) VALUE	15.92	58	16.07	52	2.41	87	2.59	82
◆ R 2000(R)	11.04	89	8.28	93	2.99	61	2.96	68
MEDIAN	17.03		16.31		3.37		3.64	

VERMONT MUNICIPAL EMPLOYEES

EQUITY PORTFOLIO CHARACTERISTICS

PERIODS ENDING 6/05

PORTFOLIO BETA

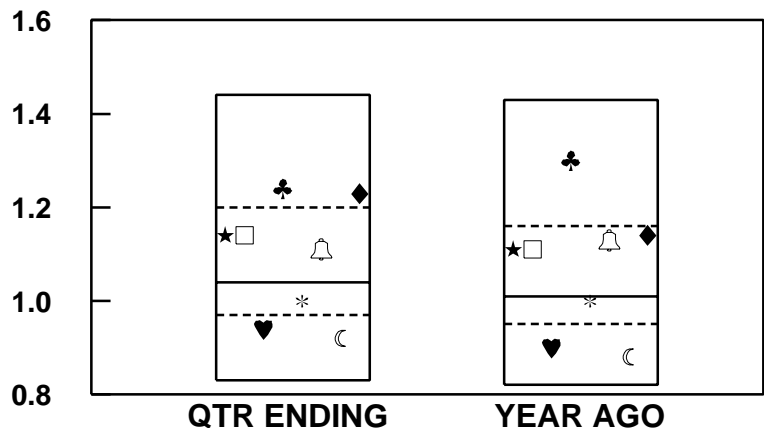

SIZE EXPOSURE

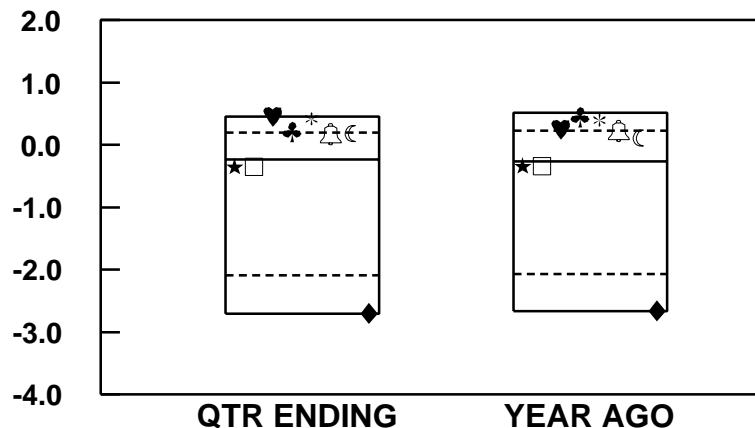

EFFECTS ON RETURN

- H
- MH
- ML
- L

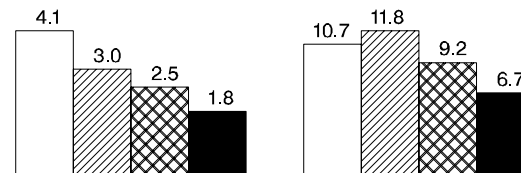
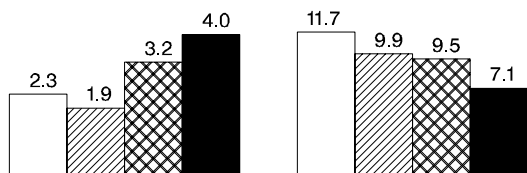

★ MUNI COMPOSITE	1.14	32	1.11	31
□ EQTY COMPOSITE	1.14	32	1.11	31
♥ DELAWARE	0.94	82	0.90	84
♣ ALLIANCE	1.24	20	1.30	13
* S&P 500	1.00	61	1.00	57
🔔 R 1000(R) GR	1.11	36	1.13	28
☾ R 1000(R) VALUE	0.92	83	0.88	88
◆ R 2000(R)	1.23	20	1.14	27

	-0.35	52	-0.34	53
	-0.35	52	-0.34	53
	0.46	4	0.26	23
	0.22	23	0.45	6
	0.42	10	0.40	8
	0.18	25	0.23	24
	0.18	27	0.11	33
	-2.70	94	-2.66	94

MEDIAN 1.04 1.01 -0.23 -0.26

NEW ENGLAND PENSION CONSULTANTS

VERMONT MUNICIPAL EMPLOYEES

EQUITY PORTFOLIO CHARACTERISTICS

PERIODS ENDING 6/05

PORTFOLIO BETA

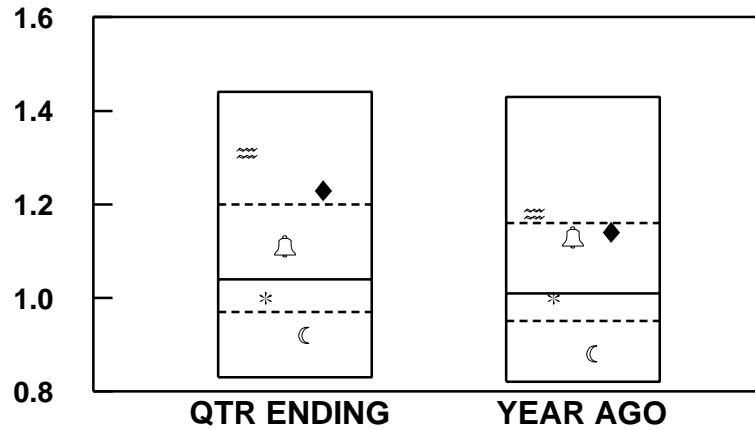

SIZE EXPOSURE

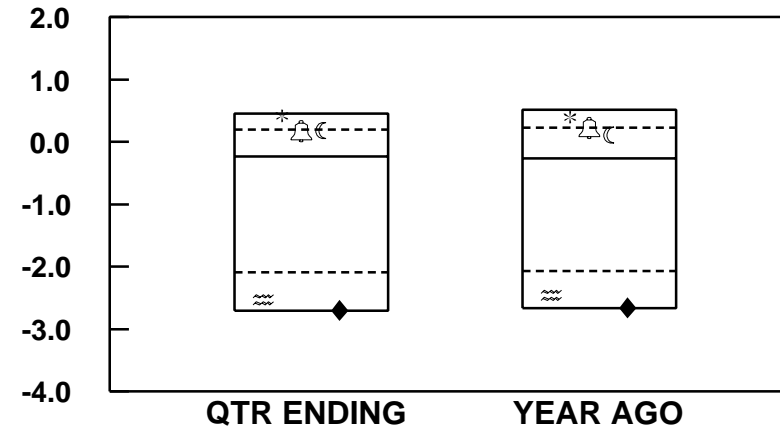

EFFECTS ON RETURN

- H
- MH
- ML
- L

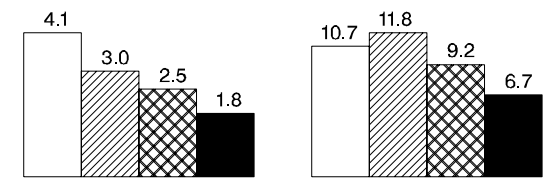
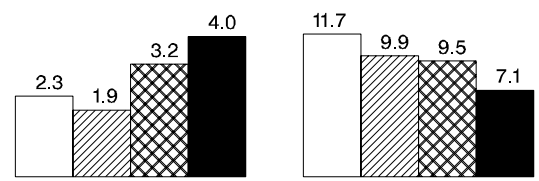

≈ LAZARD	1.31	14	1.18	22	-2.53	88	-2.45	87
* S&P 500	1.00	61	1.00	57	0.42	10	0.40	8
🔔 R 1000(R) GR	1.11	36	1.13	28	0.18	25	0.23	24
☾ R 1000(R) VALUE	0.92	83	0.88	88	0.18	27	0.11	33
◆ R 2000(R)	1.23	20	1.14	27	-2.70	94	-2.66	94
MEDIAN	1.04		1.01		-0.23		-0.26	

VERMONT MUNICIPAL EMPLOYEES

EQUITY PORTFOLIO CHARACTERISTICS

PERIODS ENDING 6/05

EQUITY R2

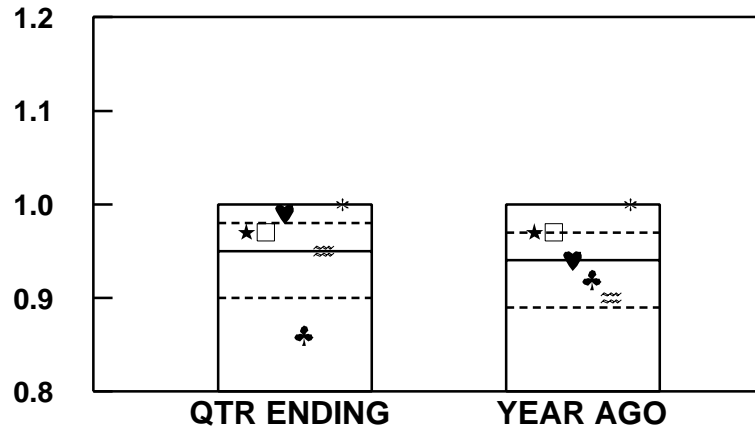

STANDARD ERROR

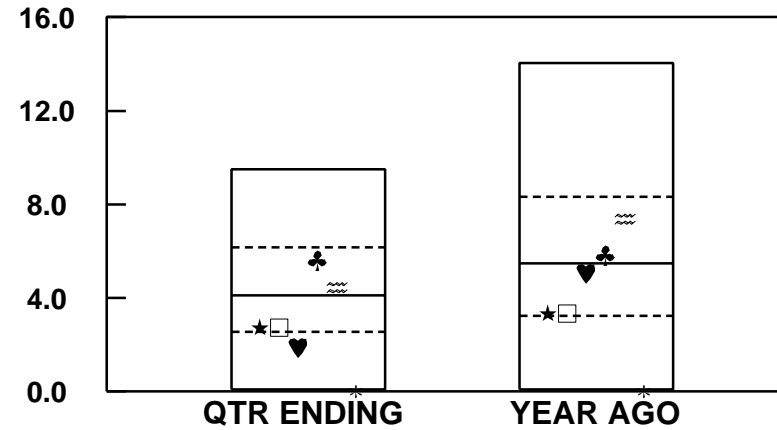

EFFECTS ON RETURN

- H
- MH
- ML
- L

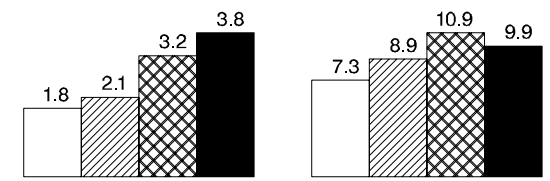
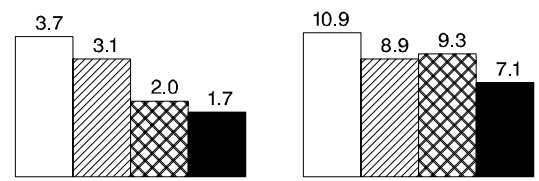

★ MUNI COMPOSITE	0.97	28	0.97	24	2.74	71	3.35	74
□ EQTY COMPOSITE	0.97	28	0.97	24	2.74	71	3.35	74
♥ DELAWARE	0.99	19	0.94	50	1.90	82	5.06	54
♣ ALLIANCE	0.86	87	0.92	61	5.60	30	5.82	46
≈ LAZARD	0.95	50	0.90	71	4.46	45	7.37	33
* S&P 500	1.00	1	1.00	1	0.00		0.00	
MEDIAN	0.95		0.94		4.10		5.48	

VERMONT MUNICIPAL EMPLOYEES

EQUITY PORTFOLIO CHARACTERISTICS

PERIODS ENDING 6/05

FINANCIAL LEVERAGE

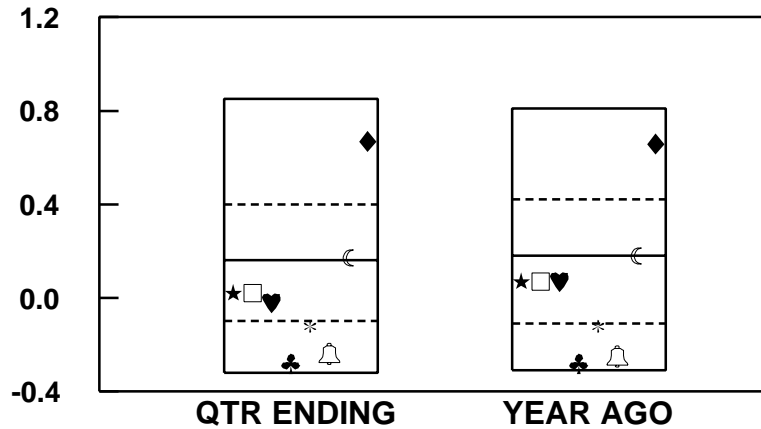

GROWTH EXPOSURE

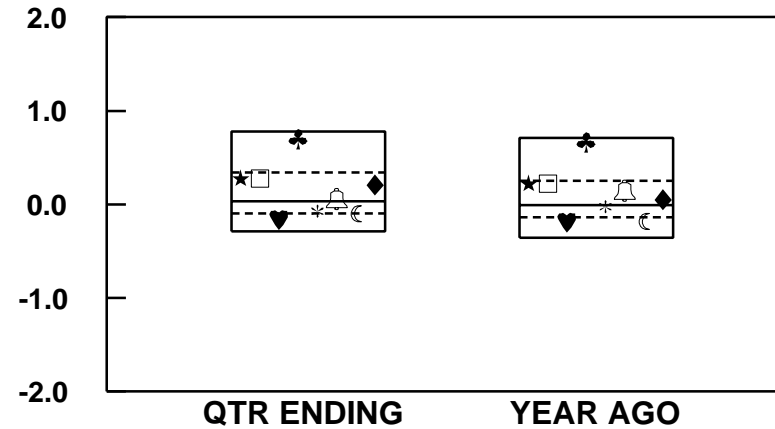

EFFECTS ON RETURN

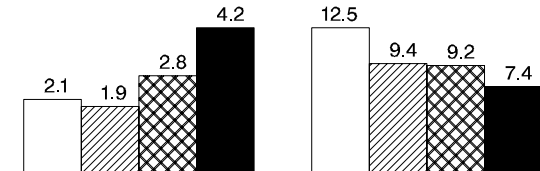
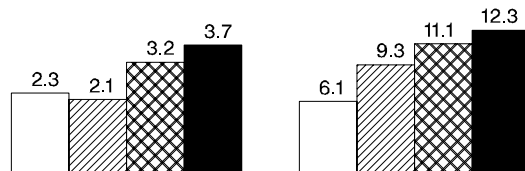
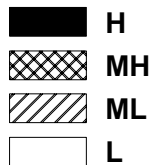

★ MUNI COMPOSITE	0.02	65	0.07	61	0.28	28	0.22	28
□ EQTY COMPOSITE	0.02	65	0.07	61	0.28	28	0.22	28
♥ DELAWARE	-0.02	67	0.07	60	-0.16	81	-0.19	81
♣ ALLIANCE	-0.28	92	-0.28	93	0.70	6	0.67	6
* S&P 500	-0.12	76	-0.12	79	-0.07	69	-0.02	52
🔔 R 1000(R) GR	-0.24	89	-0.25	90	0.06	45	0.15	32
☾ R 1000(R) VALUE	0.17	48	0.18	49	-0.10	75	-0.18	79
◆ R 2000(R)	0.67	9	0.66	11	0.21	33	0.05	42
MEDIAN	0.16		0.18		0.03		-0.01	

VERMONT MUNICIPAL EMPLOYEES

EQUITY PORTFOLIO CHARACTERISTICS

PERIODS ENDING 6/05

FINANCIAL LEVERAGE

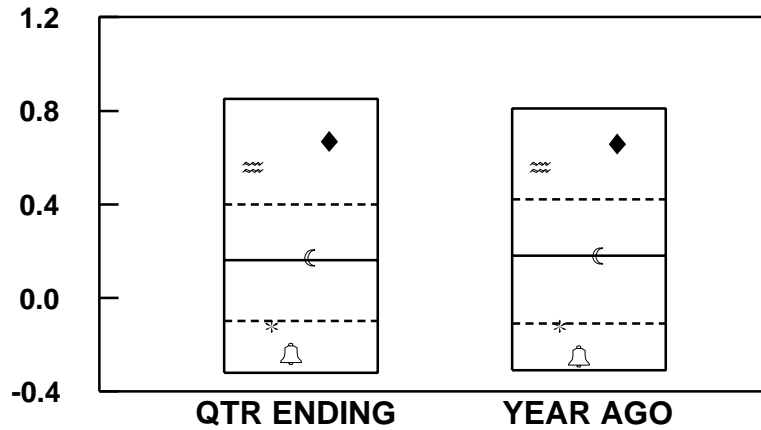

GROWTH EXPOSURE

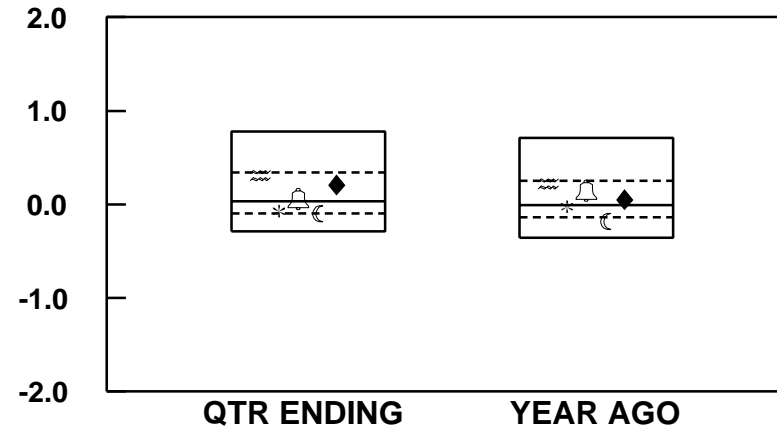

EFFECTS ON RETURN

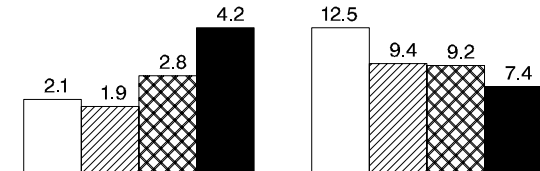
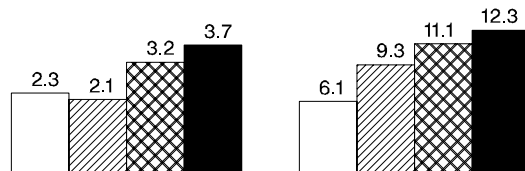
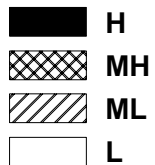

	QTR ENDING	YEAR AGO	QTR ENDING	YEAR AGO
≈ LAZARD	0.56	14	0.56	16
* S&P 500	-0.12	76	-0.12	79
🔔 R 1000(R) GR	-0.24	89	-0.25	90
☾ R 1000(R) VALUE	0.17	48	0.18	49
◆ R 2000(R)	0.67	9	0.66	11
MEDIAN	0.16	0.18	0.03	-0.01

VERMONT MUNICIPAL EMPLOYEES

DOMESTIC EQUITY ONLY PORTFOLIO CHARACTERISTICS

PERIODS ENDING 6/05

DIVIDEND YIELD

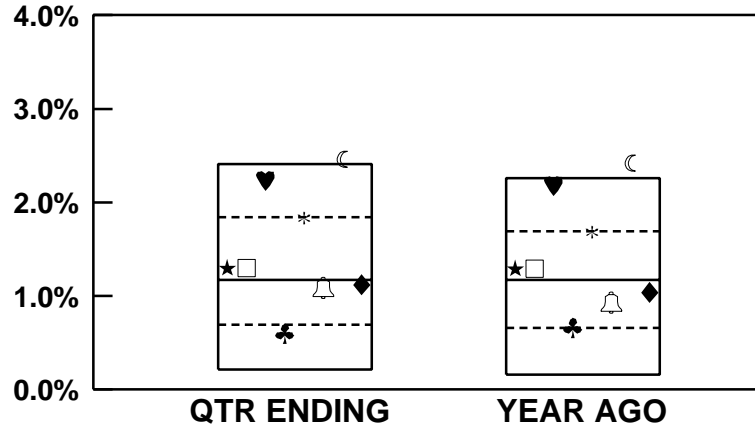

CAPITALIZATION

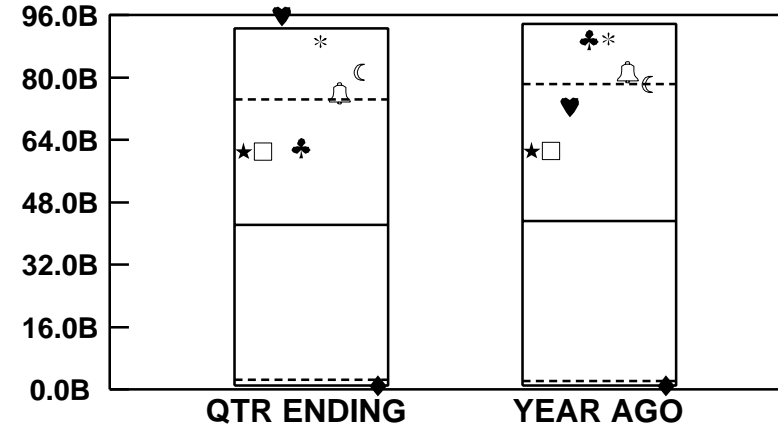

EFFECTS ON RETURN

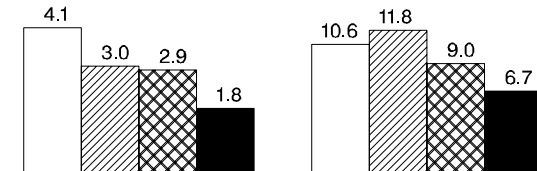
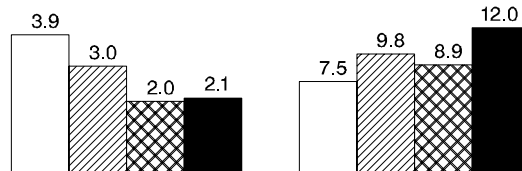
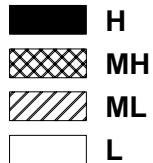

★ MUNI COMPOSITE	1.30	45	1.29	44	61.08	35	61.24	38
□ EQTY COMPOSITE	1.30	45	1.29	44	61.08	35	61.24	38
♥ DELAWARE	2.24	8	2.18	7	95.87	3	72.48	30
♣ ALLIANCE	0.60	78	0.66	74	62.08	34	89.87	7
* S&P 500	1.83	25	1.68	28	89.31	7	89.92	7
🔔 R 1000(R) GR	1.09	53	0.93	60	75.98	23	81.44	21
☾ R 1000(R) VALUE	2.46	4	2.42	2	81.36	18	78.36	24
◆ R 2000(R)	1.12	52	1.04	55	0.99	96	0.90	96
MEDIAN	1.17		1.17		42.17		43.15	

VERMONT MUNICIPAL EMPLOYEES

DOMESTIC EQUITY ONLY PORTFOLIO CHARACTERISTICS

PERIODS ENDING 6/05

DIVIDEND YIELD

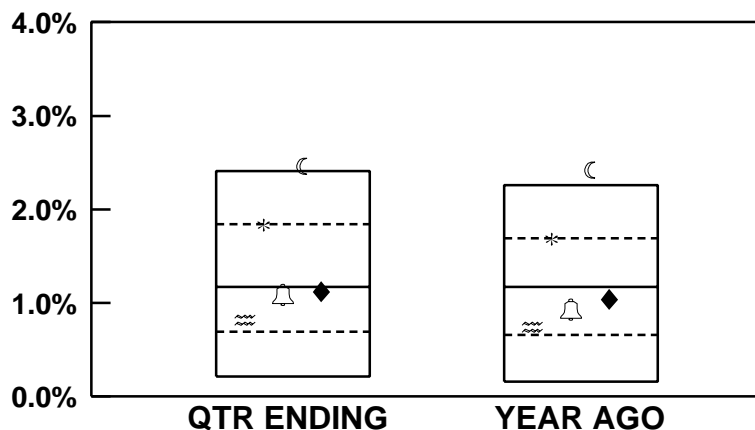

CAPITALIZATION

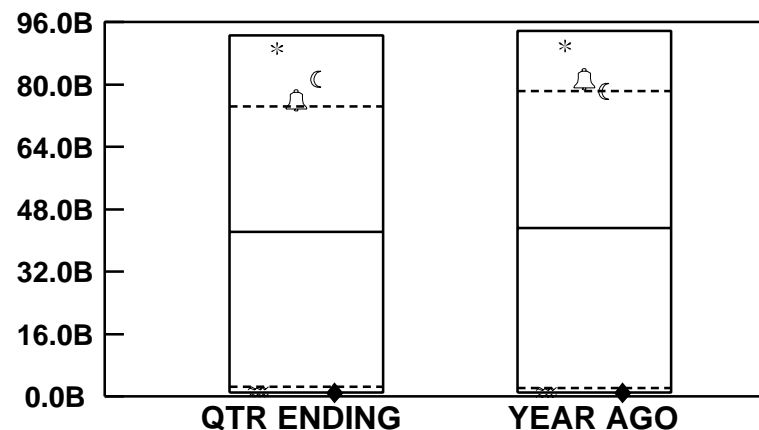

EFFECTS ON RETURN

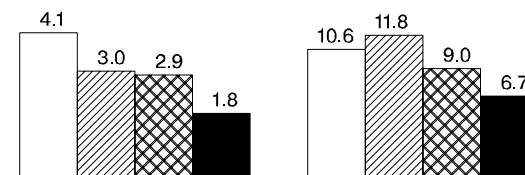
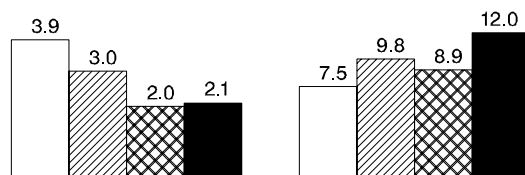
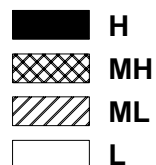

≈ LAZARD	0.82	67	0.74	70	1.22	90	1.17	89
* S&P 500	1.83	25	1.68	28	89.31	7	89.92	7
🔔 R 1000(R) GR	1.09	53	0.93	60	75.98	23	81.44	21
☾ R 1000(R) VALUE	2.46	4	2.42	2	81.36	18	78.36	24
◆ R 2000(R)	1.12	52	1.04	55	0.99	96	0.90	96
MEDIAN	1.17		1.17		42.17		43.15	

VERMONT MUNICIPAL EMPLOYEES

DOMESTIC EQUITY ONLY PORTFOLIO CHARACTERISTICS

PERIODS ENDING 6/05

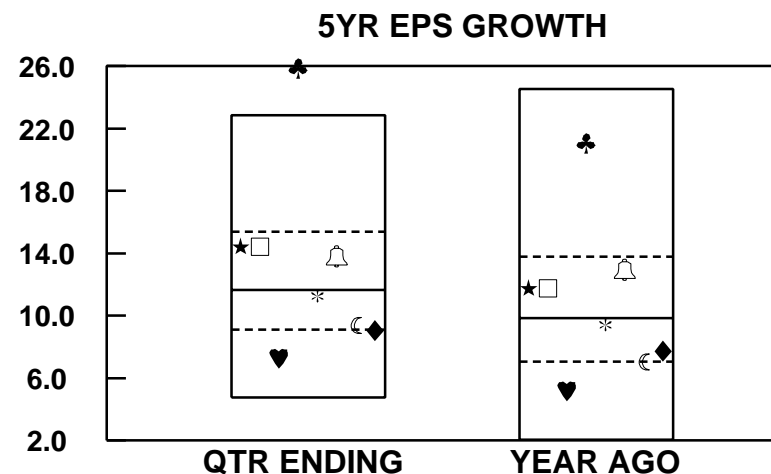
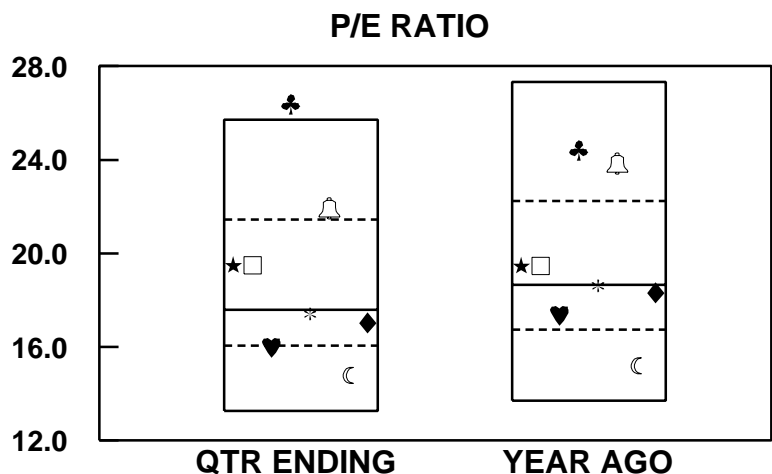

EFFECTS ON RETURN

- H
- MH
- ML
- L

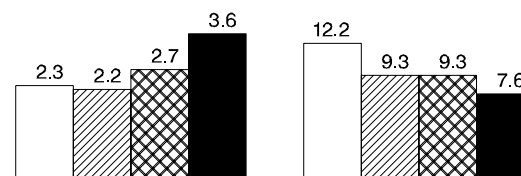
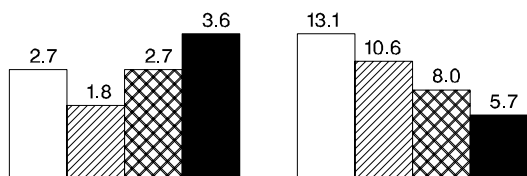

★ MUNI COMPOSITE	19.49	33	19.46	41	14.44	29	11.77	36
□ EQTY COMPOSITE	19.49	33	19.46	41	14.44	29	11.77	36
♥ DELAWARE	15.99	75	17.37	67	7.31	86	5.18	83
♣ ALLIANCE	26.39	3	24.43	14	25.89	2	21.07	8
* S&P 500	17.43	57	18.62	55	11.26	53	9.42	59
🔔 R 1000(R) GR	21.94	21	23.84	16	13.82	33	12.96	29
☾ R 1000(R) VALUE	14.78	84	15.19	86	9.38	72	7.03	75
◆ R 2000(R)	17.03	61	18.33	59	9.06	75	7.75	72
MEDIAN	17.59		18.66		11.63		9.85	

VERMONT MUNICIPAL EMPLOYEES

DOMESTIC EQUITY ONLY PORTFOLIO CHARACTERISTICS

PERIODS ENDING 6/05

P/E RATIO

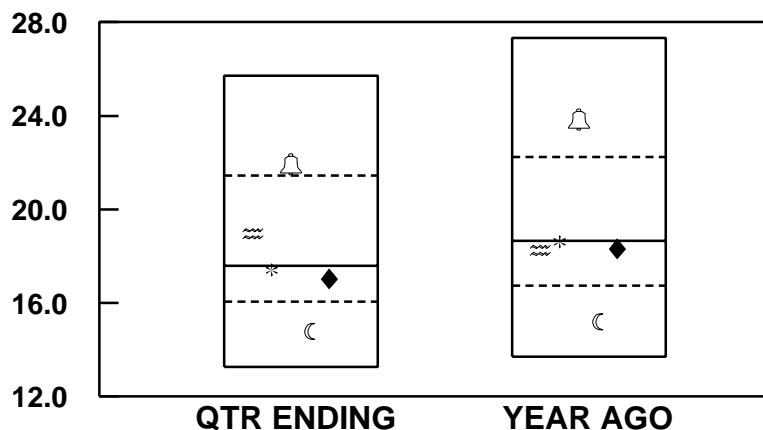

5YR EPS GROWTH

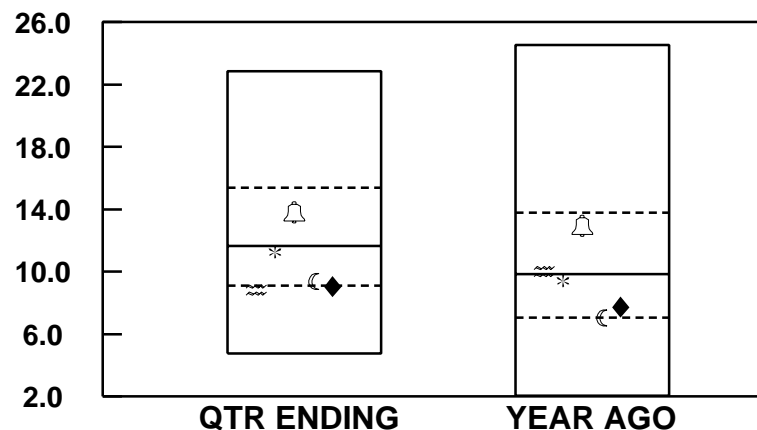

EFFECTS ON RETURN

- H
- MH
- ML
- L

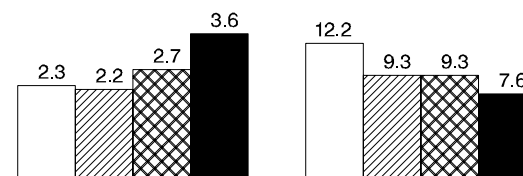
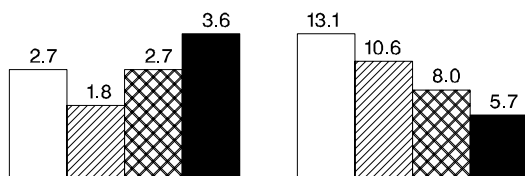

≈ LAZARD	18.98	35	18.26	59	8.82	77	10.01	48
* S&P 500	17.43	57	18.62	55	11.26	53	9.42	59
🔔 R 1000(R) GR	21.94	21	23.84	16	13.82	33	12.96	29
☾ R 1000(R) VALUE	14.78	84	15.19	86	9.38	72	7.03	75
◆ R 2000(R)	17.03	61	18.33	59	9.06	75	7.75	72
MEDIAN	17.59		18.66		11.63		9.85	

VERMONT MUNICIPAL EMPLOYEES

DOMESTIC EQUITY ONLY PORTFOLIO CHARACTERISTICS

PERIODS ENDING 6/05

RETURN ON EQUITY

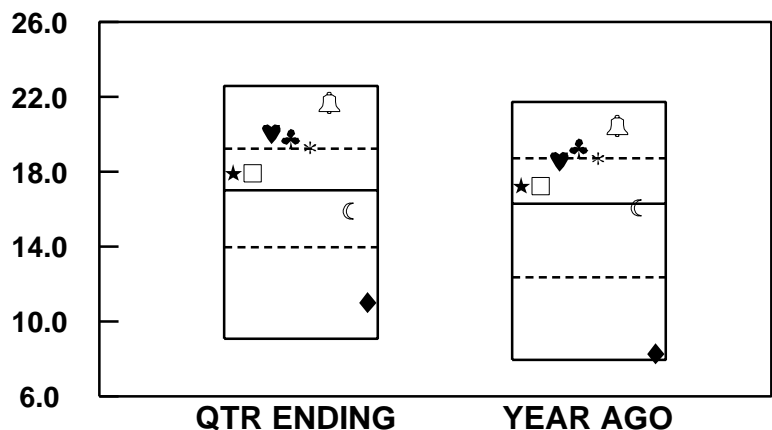

PRICE/BOOK

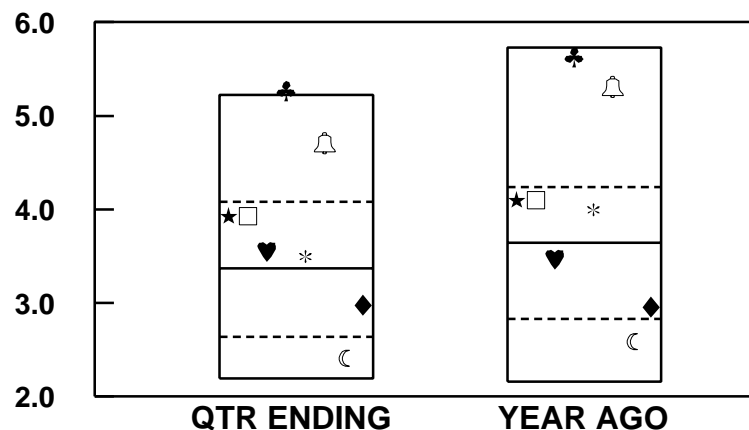

EFFECTS ON RETURN

- H
- MH
- ML
- L

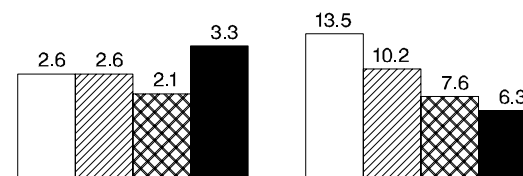
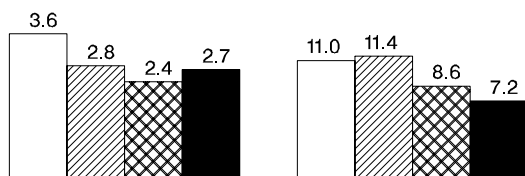

★ MUNI COMPOSITE	17.92	42	17.26	43	3.93	28	4.10	27
□ EQTY COMPOSITE	17.92	42	17.26	43	3.93	28	4.10	27
♥ DELAWARE	20.05	16	18.60	29	3.55	36	3.47	53
♣ ALLIANCE	19.78	18	19.27	16	5.27	4	5.63	6
* S&P 500	19.31	23	18.71	26	3.50	39	4.00	30
🔔 R 1000(R) GR	21.69	8	20.48	8	4.71	11	5.31	9
☾ R 1000(R) VALUE	15.92	57	16.07	52	2.41	87	2.59	82
◆ R 2000(R)	11.04	89	8.28	93	2.98	61	2.96	68
MEDIAN	17.03		16.31		3.37		3.64	

VERMONT MUNICIPAL EMPLOYEES

DOMESTIC EQUITY ONLY PORTFOLIO CHARACTERISTICS

PERIODS ENDING 6/05

RETURN ON EQUITY

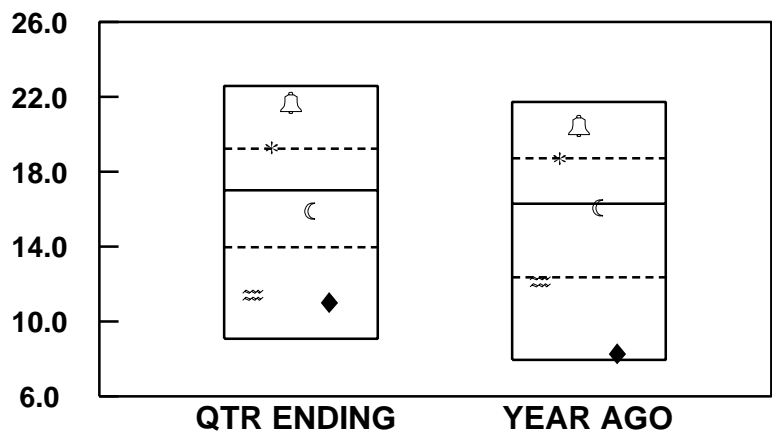

PRICE/BOOK

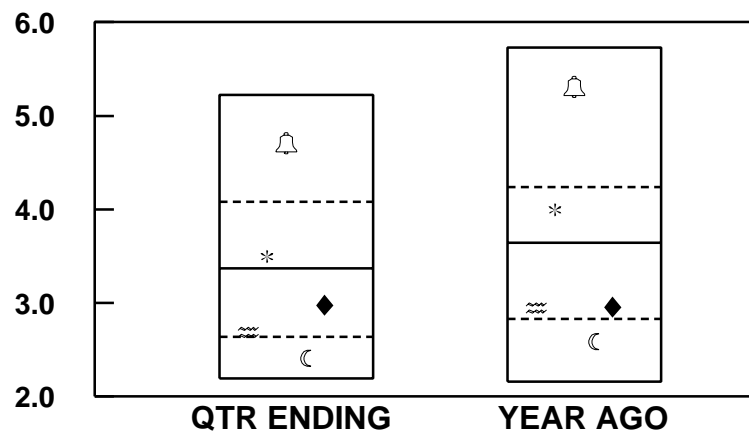

EFFECTS ON RETURN

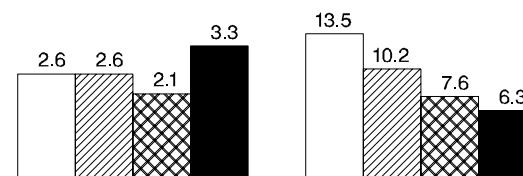
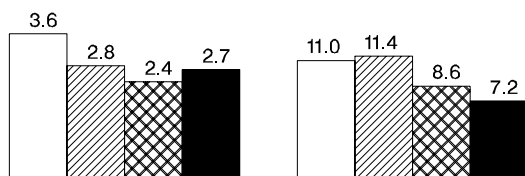
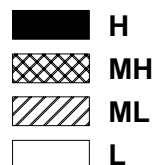

≈ LAZARD	11.44	88	12.16	79	2.69	72	2.95	68
* S&P 500	19.31	23	18.71	26	3.50	39	4.00	30
🔔 R 1000(R) GR	21.69	8	20.48	8	4.71	11	5.31	9
☾ R 1000(R) VALUE	15.92	57	16.07	52	2.41	87	2.59	82
◆ R 2000(R)	11.04	89	8.28	93	2.98	61	2.96	68
MEDIAN	17.03		16.31		3.37		3.64	

VERMONT MUNICIPAL EMPLOYEES

DOMESTIC EQUITY ONLY PORTFOLIO CHARACTERISTICS

PERIODS ENDING 6/05

PORTFOLIO BETA

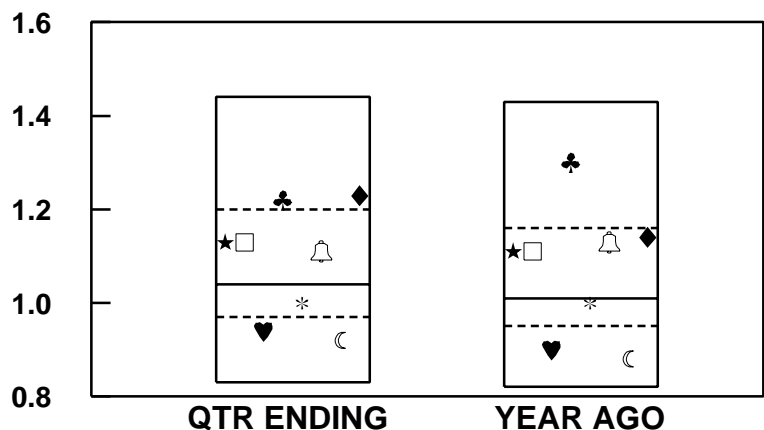

SIZE EXPOSURE

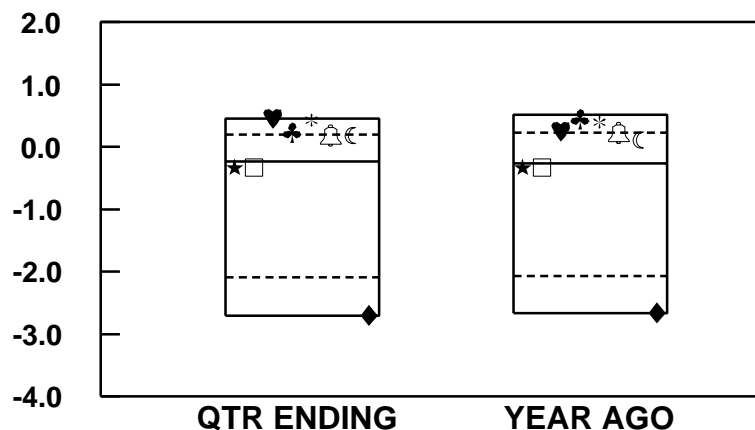

EFFECTS ON RETURN

- H
- MH
- ML
- L

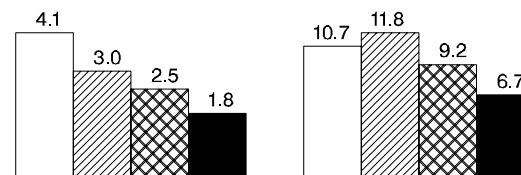
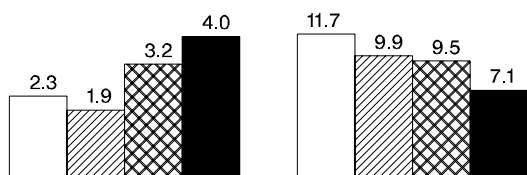

★ MUNI COMPOSITE	1.13	32	1.11	31
□ EQTY COMPOSITE	1.13	32	1.11	31
♥ DELAWARE	0.94	82	0.90	84
♣ ALLIANCE	1.22	22	1.30	13
* S&P 500	1.00	61	1.00	57
🔔 R 1000(R) GR	1.11	36	1.13	28
☾ R 1000(R) VALUE	0.92	85	0.88	88
◆ R 2000(R)	1.23	20	1.14	27

	-0.33	51	-0.33	53
	-0.33	51	-0.33	53
	0.46	4	0.26	23
	0.24	21	0.45	6
	0.43	6	0.40	8
	0.19	25	0.23	24
	0.18	27	0.11	33
	-2.70	94	-2.66	94

MEDIAN 1.04 1.01 -0.23 -0.26

NEW ENGLAND PENSION CONSULTANTS

VERMONT MUNICIPAL EMPLOYEES

DOMESTIC EQUITY ONLY PORTFOLIO CHARACTERISTICS

PERIODS ENDING 6/05

PORTFOLIO BETA

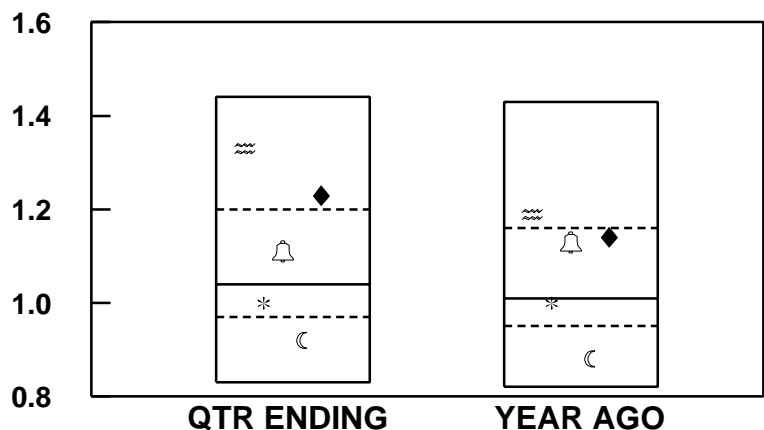

SIZE EXPOSURE

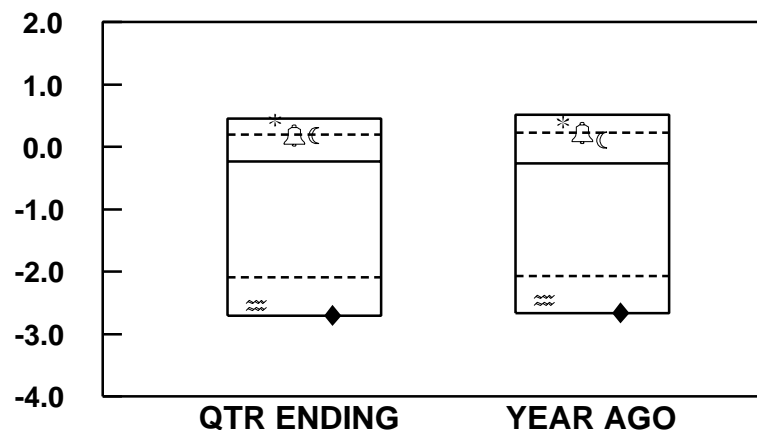

EFFECTS ON RETURN

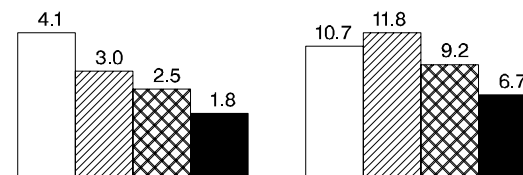
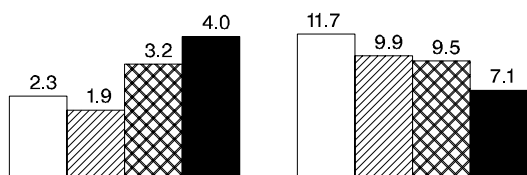
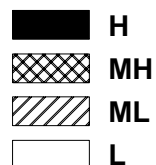

≈ LAZARD	1.33	12	1.19	21	-2.54	88	-2.45	87
* S&P 500	1.00	61	1.00	57	0.43	6	0.40	8
🔔 R 1000(R) GR	1.11	36	1.13	28	0.19	25	0.23	24
☾ R 1000(R) VALUE	0.92	85	0.88	88	0.18	27	0.11	33
◆ R 2000(R)	1.23	20	1.14	27	-2.70	94	-2.66	94
MEDIAN	1.04		1.01		-0.23		-0.26	

VERMONT MUNICIPAL EMPLOYEES

DOMESTIC EQUITY ONLY PORTFOLIO CHARACTERISTICS

PERIODS ENDING 6/05

EQUITY R2

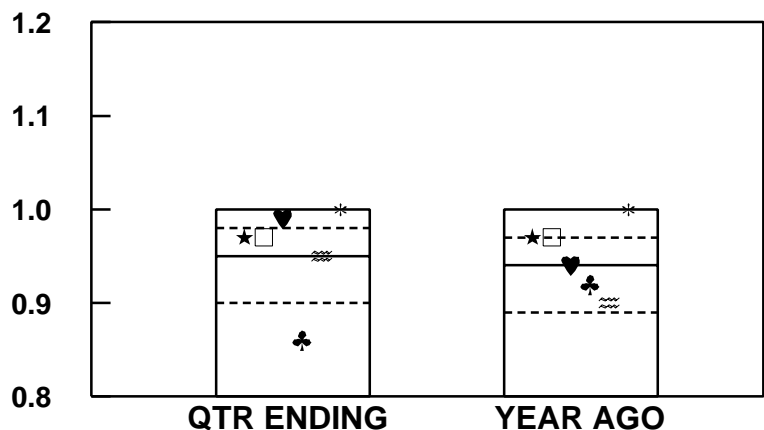

STANDARD ERROR

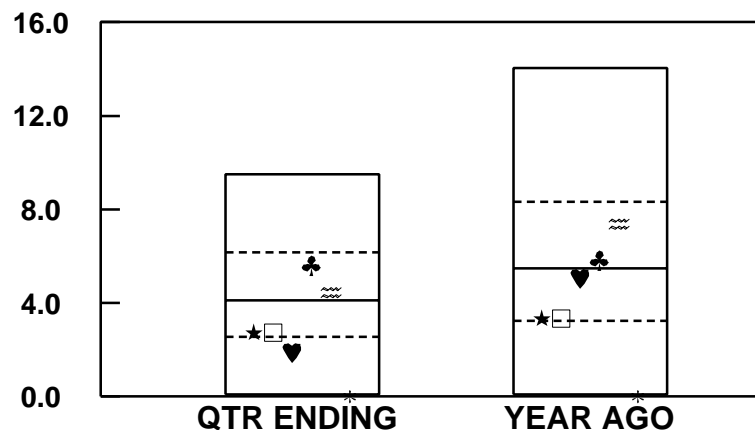

EFFECTS ON RETURN

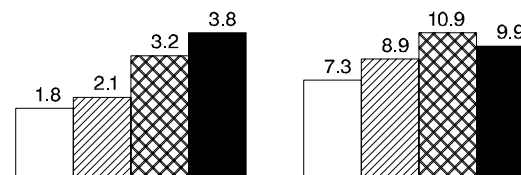
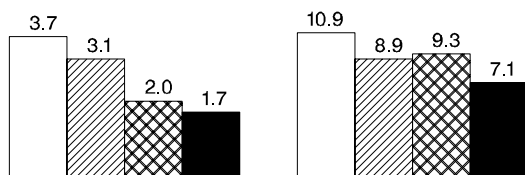
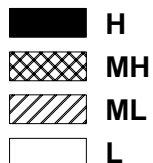

★ MUNI COMPOSITE	0.97	28	0.97	24	2.74	71	3.35	74
□ EQTY COMPOSITE	0.97	28	0.97	24	2.74	71	3.35	74
♥ DELAWARE	0.99	19	0.94	50	1.90	82	5.06	54
♣ ALLIANCE	0.86	87	0.92	61	5.60	30	5.82	46
≈ LAZARD	0.95	50	0.90	71	4.46	45	7.37	33
* S&P 500	1.00	1	1.00	1	0.00		0.00	
MEDIAN	0.95		0.94		4.10		5.48	

VERMONT MUNICIPAL EMPLOYEES

DOMESTIC EQUITY ONLY PORTFOLIO CHARACTERISTICS

PERIODS ENDING 6/05

FINANCIAL LEVERAGE

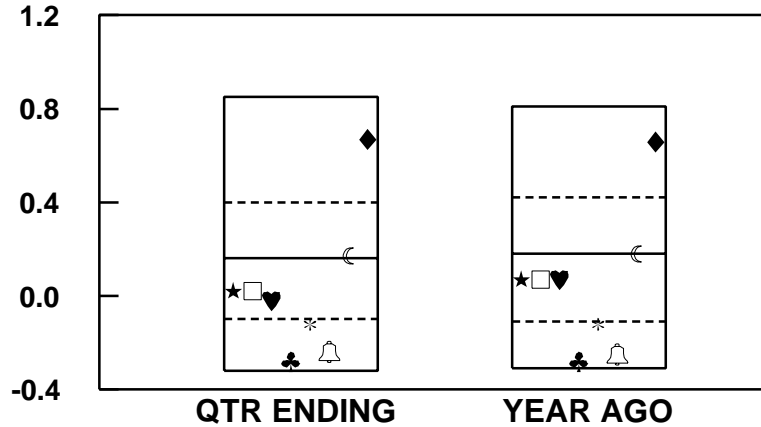

GROWTH EXPOSURE

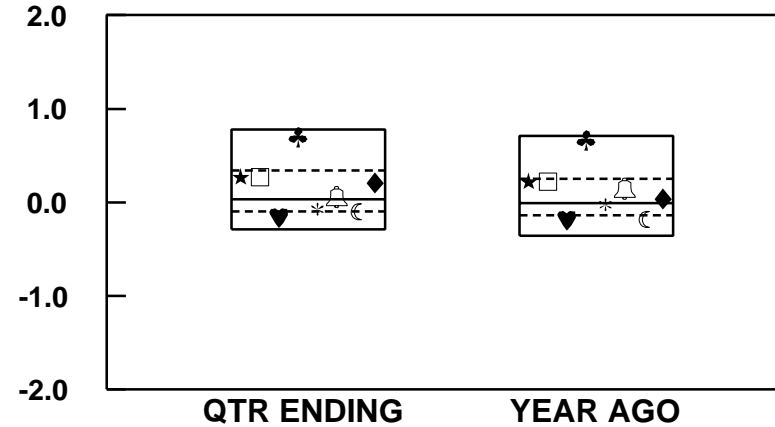

EFFECTS ON RETURN

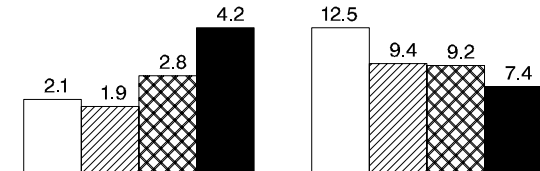
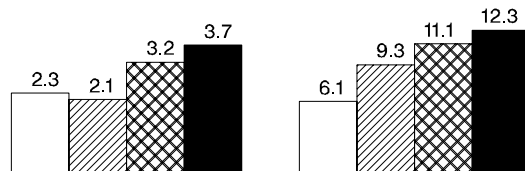
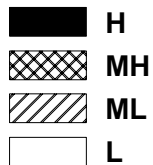

★ MUNI COMPOSITE	0.02	64	0.07	61	0.27	29	0.22	28
□ EQTY COMPOSITE	0.02	64	0.07	61	0.27	29	0.22	28
♥ DELAWARE	-0.02	67	0.07	60	-0.16	81	-0.19	81
♣ ALLIANCE	-0.28	92	-0.28	93	0.70	7	0.67	6
* S&P 500	-0.12	76	-0.12	79	-0.07	69	-0.02	52
🔔 R 1000(R) GR	-0.24	89	-0.25	90	0.06	45	0.15	32
☾ R 1000(R) VALUE	0.17	48	0.18	49	-0.10	74	-0.18	79
◆ R 2000(R)	0.67	9	0.66	11	0.21	33	0.04	42
MEDIAN	0.16		0.18		0.03		-0.01	

VERMONT MUNICIPAL EMPLOYEES

DOMESTIC EQUITY ONLY PORTFOLIO CHARACTERISTICS

PERIODS ENDING 6/05

FINANCIAL LEVERAGE

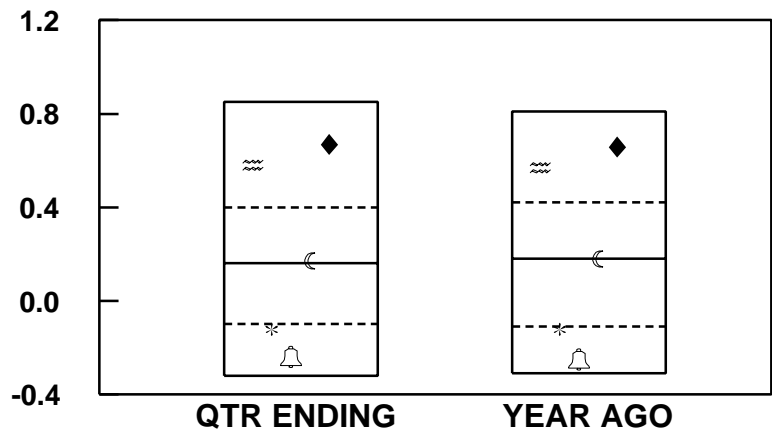

GROWTH EXPOSURE

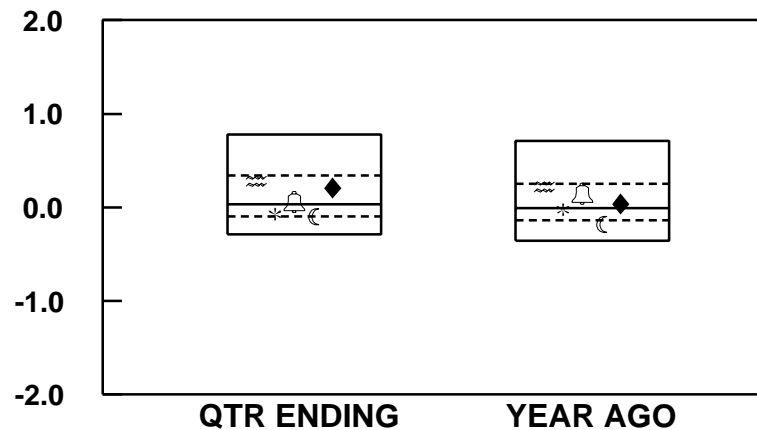

EFFECTS ON RETURN

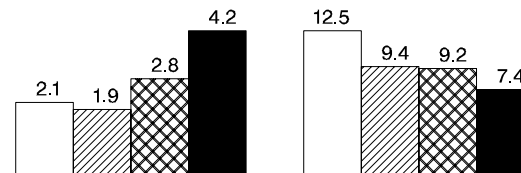
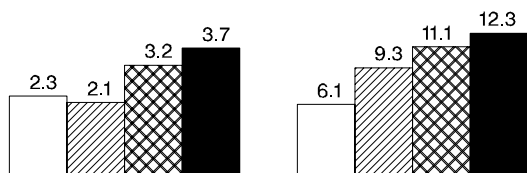
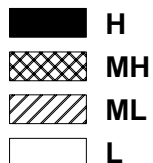

	QTR ENDING	YEAR AGO	QTR ENDING	YEAR AGO
≈ LAZARD	0.58	13	0.57	15
* S&P 500	-0.12	76	-0.12	79
🔔 R 1000(R) GR	-0.24	89	-0.25	90
☾ R 1000(R) VALUE	0.17	48	0.18	49
◆ R 2000(R)	0.67	9	0.66	11
MEDIAN	0.16	0.18	0.03	-0.01

VERMONT MUNICIPAL EMPLOYEES

DIVERSIFICATION BY INDUSTRY SECTOR

QUARTER ENDING 6/05

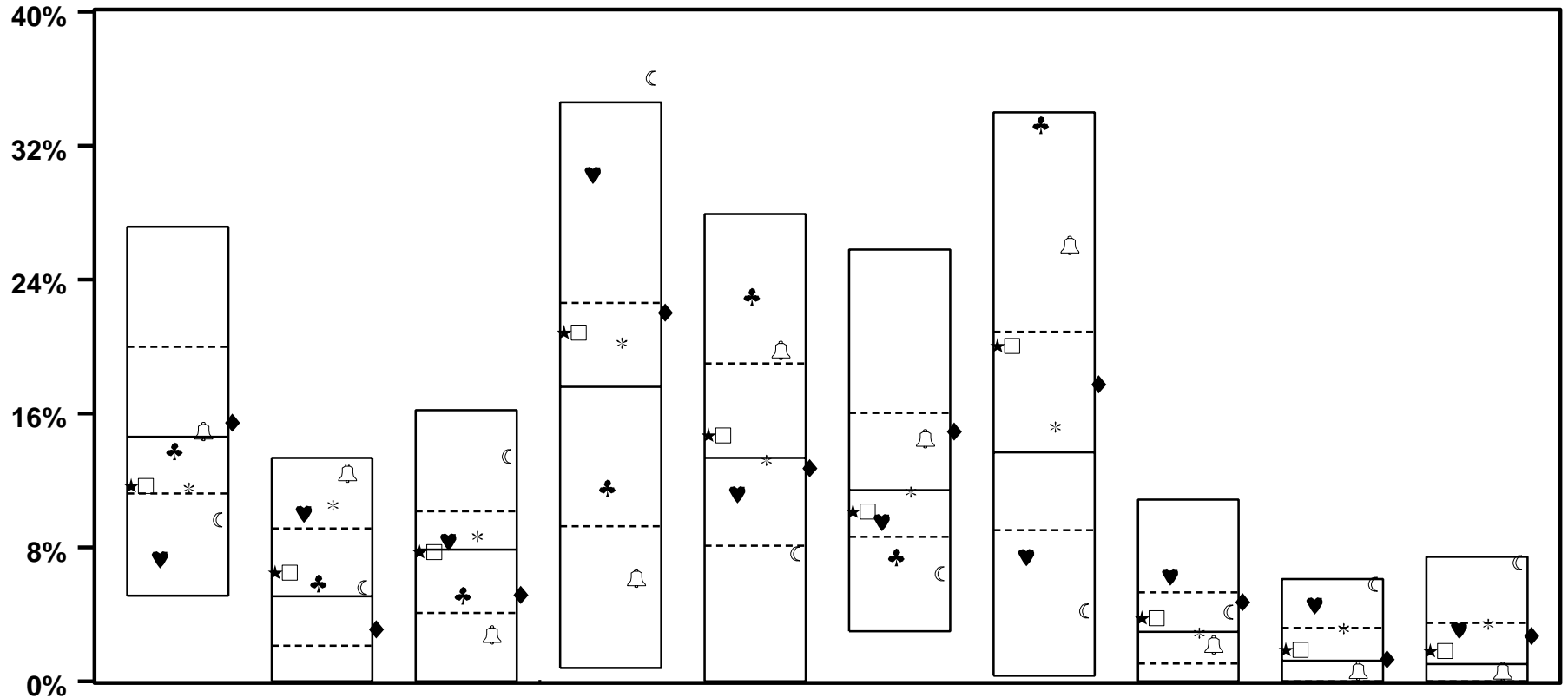

	CONSUMER DISCR		CONSUMER STAPLES		EN-ERGY		FINAN-CIALS		HEALTH CARE		INDUST-RIALS		INFO TECH		MATER-IALS		TELECOM SERVICES		UTIL-ITIES	
★ MUNI COMPOSITE	11.7	67	6.5	39	7.7	50	20.8	30	14.7	39	10.1	66	20.1	26	3.8	37	1.9	42	1.8	44
□ EQTY COMPOSITE	11.7	67	6.5	39	7.7	50	20.8	30	14.7	39	10.1	66	20.1	26	3.8	37	1.9	42	1.8	44
♥ DELAWARE	7.3	92	10.0	20	8.3	46	30.3	11	11.2	63	9.5	70	7.4	80	6.3	20	4.5	12	3.1	35
♣ ALLIANCE	13.8	54	5.9	42	5.2	68	11.5	67	23.0	12	7.4	79	33.3	5						
* S&P 500	11.5	69	10.5	11	8.6	43	20.2	39	13.2	54	11.3	55	15.2	40	2.9	56	3.1	28	3.4	31
🔔 R 1000(R) GR	14.9	47	12.4	6	2.8	81	6.2	85	19.8	21	14.5	32	26.0	13	2.2	66	0.6	57	0.6	53
☾ R 1000(R) VALUE	9.6	84	5.6	45	13.4	13	36.0	3	7.6	76	6.4	84	4.2	89	4.2	34	5.8	6	7.1	6
◆ R 2000(R)	15.5	43	3.1	65	5.2	68	22.0	26	12.7	56	14.9	29	17.8	32	4.7	30	1.3	49	2.7	38
MEDIAN	14.6		5.1		7.9		17.6		13.3		11.4		13.7		2.9		1.2		1.0	

VERMONT MUNICIPAL EMPLOYEES

DIVERSIFICATION BY INDUSTRY SECTOR

QUARTER ENDING 6/05

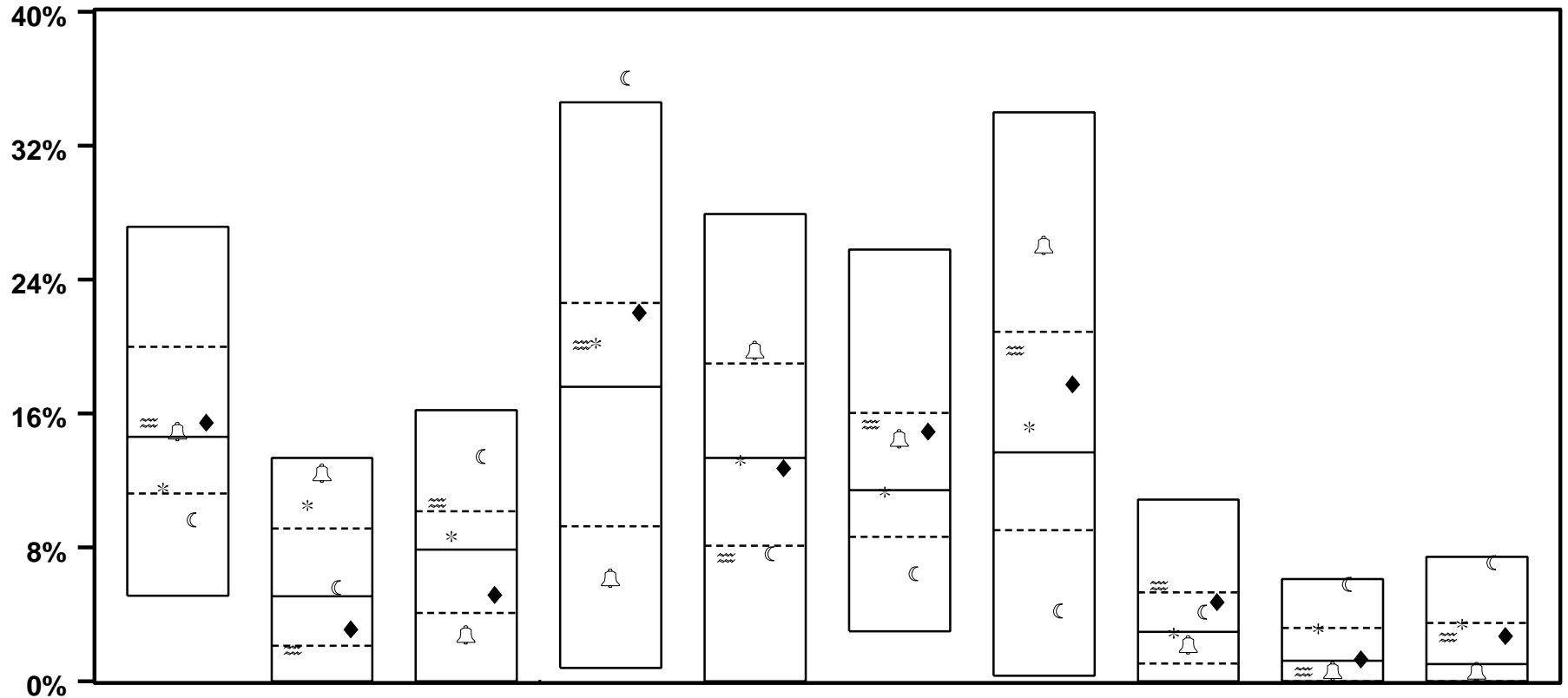

	CONSUMER DISCR		CONSUMER STAPLES		EN-ERGY		FINAN-CIALS		HEALTH CARE		INDUST-RIALS		INFO TECH		MATER-IALS		TELECOM SERVICES		UTIL-ITIES	
≈ LAZARD	15.5	44	1.9	78	10.7	21	20.1	40	7.4	77	15.3	27	19.8	27	5.7	22	0.6	57	2.6	39
* S&P 500	11.5	69	10.5	11	8.6	43	20.2	39	13.2	54	11.3	55	15.2	40	2.9	56	3.1	28	3.4	31
🔔 R 1000(R) GR	14.9	47	12.4	6	2.8	81	6.2	85	19.8	21	14.5	32	26.0	13	2.2	66	0.6	57	0.6	53
☾ R 1000(R) VALUE	9.6	84	5.6	45	13.4	13	36.0	3	7.6	76	6.4	84	4.2	89	4.2	34	5.8	6	7.1	6
◆ R 2000(R)	15.5	43	3.1	65	5.2	68	22.0	26	12.7	56	14.9	29	17.8	32	4.7	30	1.3	49	2.7	38
MEDIAN	14.6		5.1		7.9		17.6		13.3		11.4		13.7		2.9		1.2		1.0	

VERMONT MUNICIPAL EMPLOYEES

RATES OF RETURN BY INDUSTRY SECTOR

QUARTER ENDING 6/05

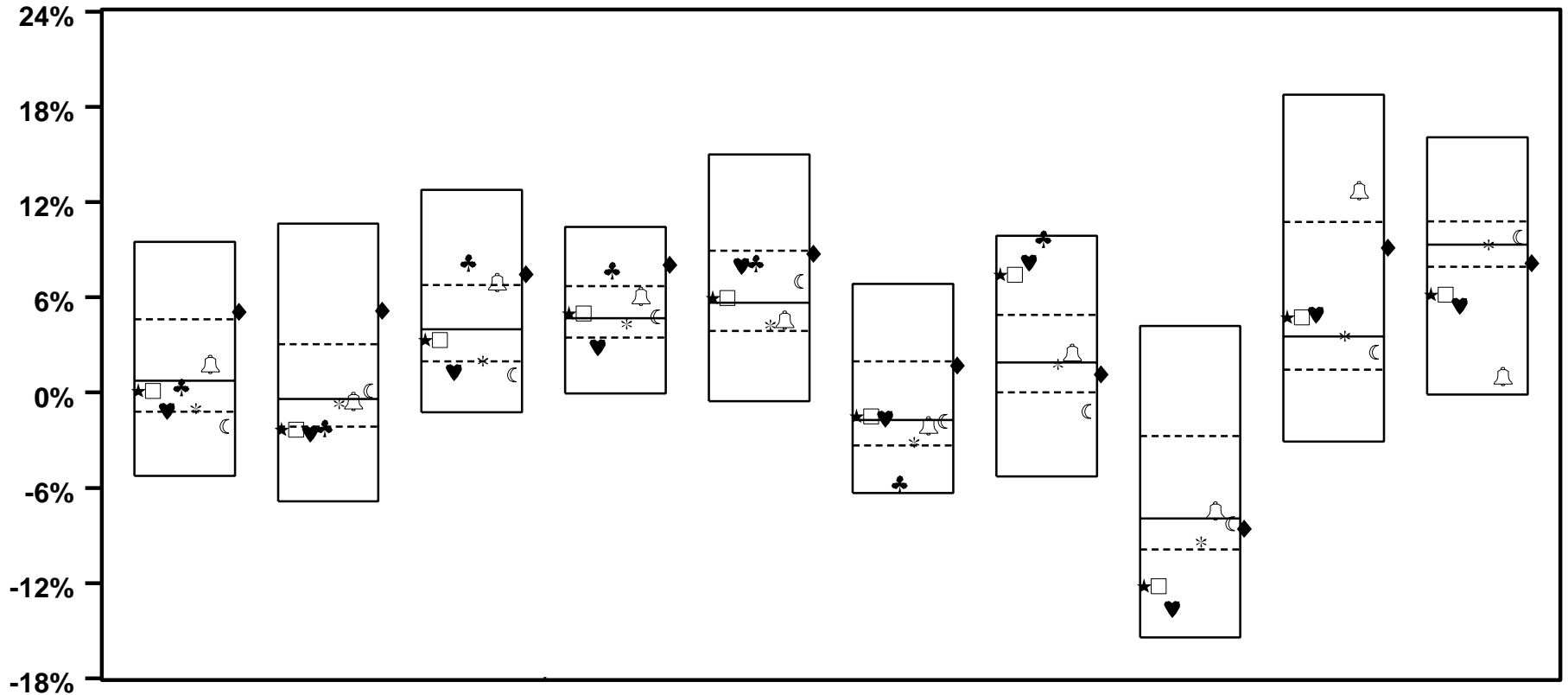

	CONSUMER DISCR		CONSUMER STAPLES		EN-ERGY		FINAN-CIALS		HEALTH CARE		INDUST-RIALS		INFO TECH		MATER-IALS		TELECOM SERVICES		UTIL-ITIES	
★ MUNI COMPOSITE	0.1	56	-2.3	75	3.3	57	5.0	45	6.0	46	-1.5	47	7.4	10	-12.2	86	4.8	42	6.2	84
□ EQTY COMPOSITE	0.1	56	-2.3	75	3.3	57	5.0	45	6.0	46	-1.5	47	7.4	10	-12.2	86	4.8	42	6.2	84
♥ DELAWARE	-1.2	73	-2.6	76	1.3	82	2.9	79	8.0	31	-1.6	49	8.2	8	-13.6	91	4.9	41	5.5	87
♣ ALLIANCE	0.4	54	-2.2	75	8.2	16	7.7	16	8.2	30	-5.7	91	9.7	5						
* S&P 500	-1.0	65	-0.7	60	2.0	68	4.3	58	4.3	63	-3.1	66	1.8	51	-9.4	61	3.6	49	9.3	51
🔔 R 1000(R) GR	1.8	41	-0.6	51	6.9	24	6.1	33	4.6	60	-2.1	53	2.5	43	-7.5	46	12.7	17	1.0	92
🌙 R 1000(R) VALUE	-2.1	80	0.1	43	1.1	84	4.8	48	7.0	37	-1.8	50	-1.2	81	-8.2	52	2.5	66	9.8	37
◆ R 2000(R)	5.1	22	5.2	18	7.5	20	8.1	14	8.7	26	1.7	26	1.2	63	-8.6	56	9.1	30	8.2	72
MEDIAN	0.8		-0.4		4.0		4.7		5.7		-1.7		1.9		-7.9		3.5		9.3	

VERMONT MUNICIPAL EMPLOYEES

RATES OF RETURN BY INDUSTRY SECTOR

QUARTER ENDING 6/05

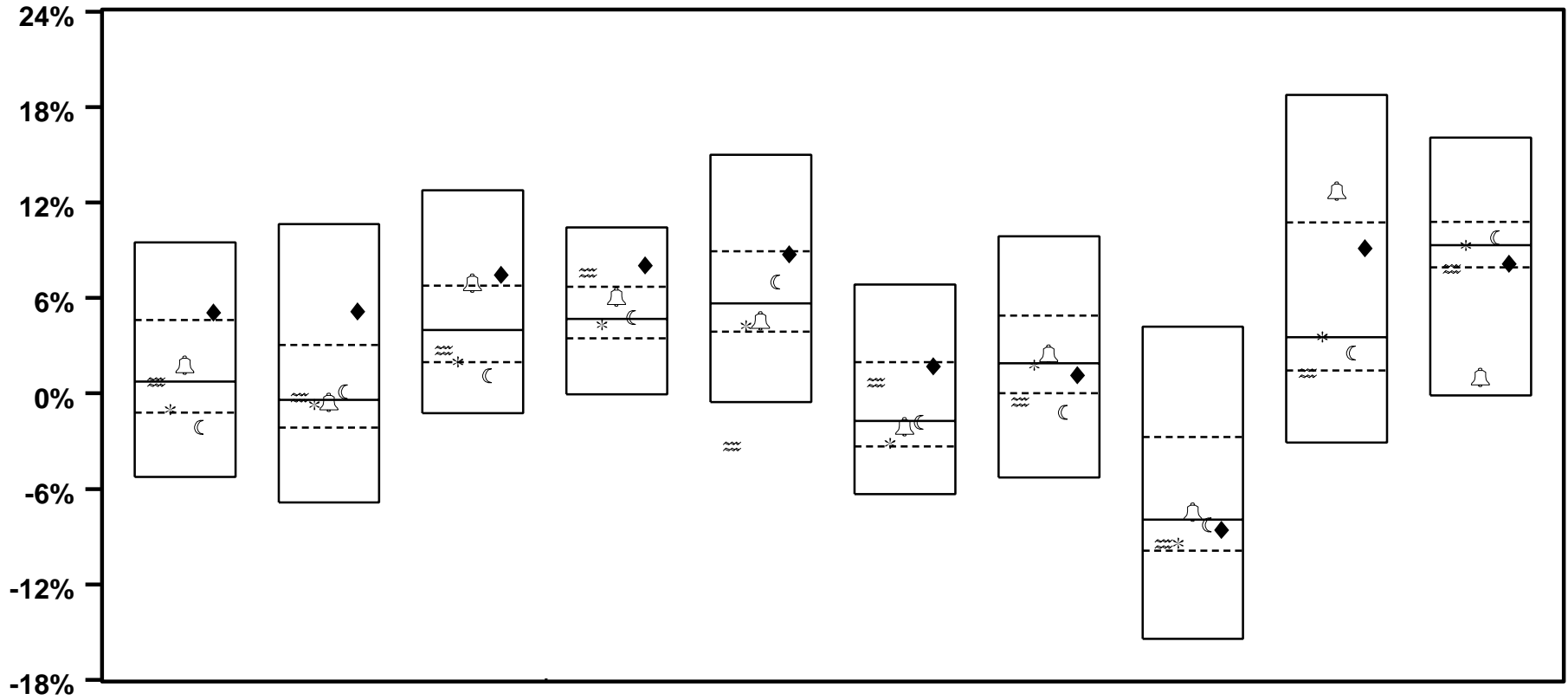

	CONSUMER DISCR		CONSUMER STAPLES		EN-ERGY		FINAN-CIALS		HEALTH CARE		INDUST-RIALS		INFO TECH		MATER-IALS		TELECOM SERVICES		UTIL-ITIES	
≈ LAZARD	0.7	50	-0.3	48	2.7	62	7.6	17	-3.3	98	0.7	34	-0.5	78	-9.4	62	1.3	75	7.8	75
* S&P 500	-1.0	65	-0.7	60	2.0	68	4.3	58	4.3	63	-3.1	66	1.8	51	-9.4	61	3.6	49	9.3	51
🔔 R 1000(R) GR	1.8	41	-0.6	51	6.9	24	6.1	33	4.6	60	-2.1	53	2.5	43	-7.5	46	12.7	17	1.0	92
🌙 R 1000(R) VALUE	-2.1	80	0.1	43	1.1	84	4.8	48	7.0	37	-1.8	50	-1.2	81	-8.2	52	2.5	66	9.8	37
◆ R 2000(R)	5.1	22	5.2	18	7.5	20	8.1	14	8.7	26	1.7	26	1.2	63	-8.6	56	9.1	30	8.2	72
MEDIAN	0.8		-0.4		4.0		4.7		5.7		-1.7		1.9		-7.9		3.5		9.3	

VERMONT MUNICIPAL EMPLOYEES

RATES OF RETURN BY INDUSTRY SECTOR

YEAR ENDING 6/05

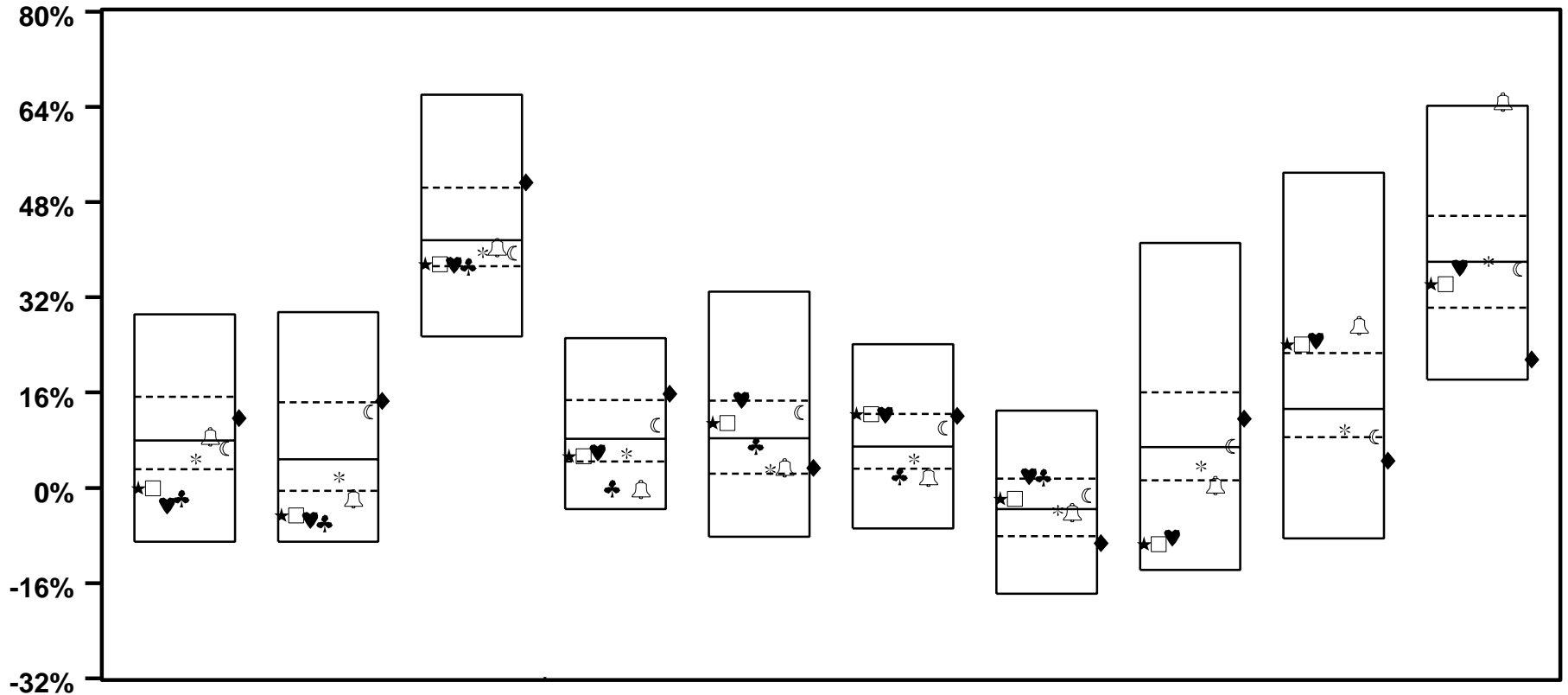

	CONSUMER DISCR		CONSUMER STAPLES		EN-ERGY		FINAN-CIALS		HEALTH CARE		INDUST-RIALS		INFO TECH		MATER-IALS		TELECOM SERVICES		UTIL-ITIES	
★ MUNI COMPOSITE	-0.1	85	-4.6	89	37.6	73	5.3	70	10.9	35	12.4	25	-1.8	37	-9.4	93	24.1	24	34.2	65
□ EQTY COMPOSITE	-0.1	85	-4.6	89	37.6	73	5.3	70	10.9	35	12.4	25	-1.8	37	-9.4	93	24.1	24	34.2	65
♥ DELAWARE	-3.0	90	-5.4	90	37.5	73	6.0	60	14.8	24	12.3	25	1.9	23	-8.4	92	24.8	23	37.1	56
♣ ALLIANCE	-1.7	88	-5.9	91	37.2	75	-0.1	88	7.1	56	2.0	80	1.8	24						
* S&P 500	4.9	61	1.8	69	39.5	60	5.8	62	3.1	70	4.8	66	-3.8	51	3.6	61	9.7	58	38.0	44
🔔 R 1000(R) GR	8.6	47	-1.8	80	40.4	56	-0.3	88	3.4	68	1.8	80	-4.2	57	0.4	76	27.3	19	64.8	4
🌙 R 1000(R) VALUE	6.6	54	12.8	28	39.5	61	10.5	38	12.6	29	10.1	35	-1.3	35	6.9	49	8.6	74	36.7	59
◆ R 2000(R)	11.7	36	14.6	24	51.3	22	15.9	18	3.4	68	12.1	26	-9.3	79	11.7	34	4.6	82	21.6	89
MEDIAN	8.0		4.8		41.6		8.3		8.3		6.9		-3.6		6.9		13.2		38.0	

VERMONT MUNICIPAL EMPLOYEES

RATES OF RETURN BY INDUSTRY SECTOR

YEAR ENDING 6/05

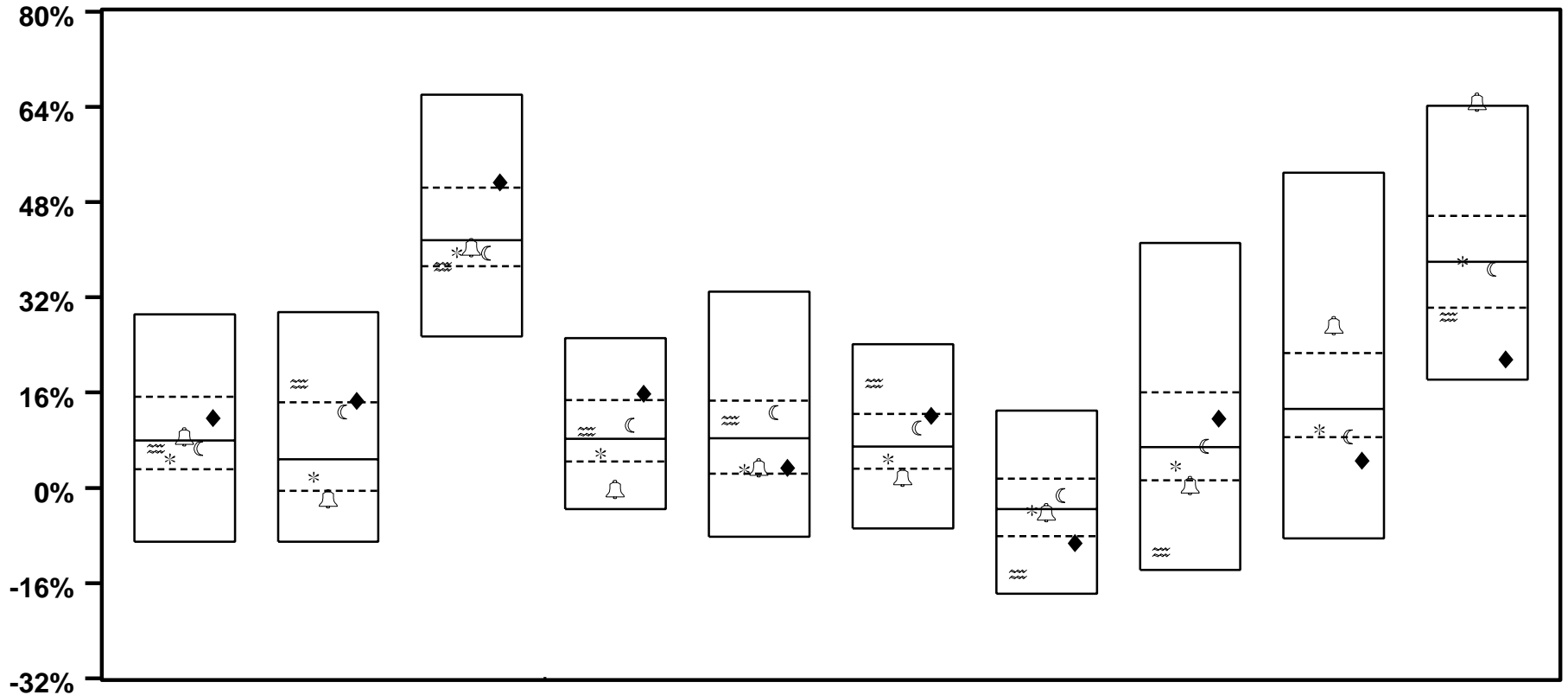

	CONSUMER DISCR		CONSUMER STAPLES		EN-ERGY		FINAN-CIALS		HEALTH CARE		INDUST-RIALS		INFO TECH		MATER-IALS		TELECOM SERVICES		UTIL-ITIES	
≈ LAZARD	6.6	54	17.5	19	37.2	75	9.4	44	11.3	33	17.5	13	-14.5	91	-10.8	93			28.7	78
* S&P 500	4.9	61	1.8	69	39.5	60	5.8	62	3.1	70	4.8	66	-3.8	51	3.6	61	9.7	58	38.0	44
🔔 R 1000(R) GR	8.6	47	-1.8	80	40.4	56	-0.3	88	3.4	68	1.8	80	-4.2	57	0.4	76	27.3	19	64.8	4
🌙 R 1000(R) VALUE	6.6	54	12.8	28	39.5	61	10.5	38	12.6	29	10.1	35	-1.3	35	6.9	49	8.6	74	36.7	59
◆ R 2000(R)	11.7	36	14.6	24	51.3	22	15.9	18	3.4	68	12.1	26	-9.3	79	11.7	34	4.6	82	21.6	89
MEDIAN	8.0		4.8		41.6		8.3		8.3		6.9		-3.6		6.9		13.2		38.0	

VERMONT MUNICIPAL EMPLOYEES
EQUITY PERFORMANCE ATTRIBUTION
QUARTER ENDING 6/05

MUNICIPAL SYSTEM COMPOSITE

	PORTFOLIO		S&P 500		SELECTION		
	PCT OF BEGIN MKT VAL A	RATE OF RETURN B	PCT OF BEGIN MKT VAL C	RATE OF RETURN D	STOCK E	SECTOR F	TOTAL G
CONS DISCRETIONARY	13.1	0.1	11.7	-1.0	0.1	0.0	0.1
CONSUMER STAPLES	6.2	-2.3	10.8	-0.7	-0.1	0.1	0.0
ENERGY	8.0	3.3	8.7	2.0	0.1	0.0	0.1
FINANCIALS	20.5	5.0	19.7	4.3	0.1	0.0	0.2
HEALTH CARE	13.1	6.0	12.8	4.3	0.2	0.0	0.2
INDUSTRIALS	10.2	-1.5	11.8	-3.1	0.2	0.1	0.2
INFO TECHNOLOGY	20.5	7.4	15.2	1.8	1.2	0.0	1.2
MATERIALS	3.7	-12.2	3.2	-9.4	-0.1	-0.1	-0.2
TELECOM SERVICES	1.9	4.8	3.1	3.6	0.0	0.0	0.0
UTILITIES	1.8	6.2	3.1	9.3	-0.1	-0.1	-0.2
MISCELLANEOUS	0.9	2.6	0.0		0.0	0.0	0.0
	100.0%	3.1	100.0%	1.4	1.7	0.0	1.7

EQUITY ONLY BUY&HOLD RETURN (B)	3.1	STOCK SELECTION (E)	1.7
BENCHMARK BUY&HOLD RETURN (D)	1.4	SECTOR WEIGHTING (F)	0.0
TOTAL RELATIVE RETURN DIFFERENCE (B/D)	1.7	TOTAL SELECTION (E * F)	1.7
EQUITY ONLY ACTUAL RETURN (*)	3.3		
EQUITY ONLY BUY&HOLD RETURN (B)	3.1		
INTRA-PERIOD TRADING (* / B)	0.2		
TOTAL ACTIVE MANAGEMENT VALUE ADDED (SELECTION * TRADING)	1.9		

VERMONT MUNICIPAL EMPLOYEES
EQUITY PERFORMANCE ATTRIBUTION
QUARTER ENDING 6/05

DOMESTIC EQUITY COMPOSITE

	PORTFOLIO		S&P 500		SELECTION		
	PCT OF BEGIN MKT VAL A	RATE OF RETURN B	PCT OF BEGIN MKT VAL C	RATE OF RETURN D	STOCK E	SECTOR F	TOTAL G
CONS DISCRETIONARY	13.1	0.1	11.7	-1.0	0.1	0.0	0.1
CONSUMER STAPLES	6.2	-2.3	10.8	-0.7	-0.1	0.1	0.0
ENERGY	8.0	3.3	8.7	2.0	0.1	0.0	0.1
FINANCIALS	20.5	5.0	19.7	4.3	0.1	0.0	0.2
HEALTH CARE	13.1	6.0	12.8	4.3	0.2	0.0	0.2
INDUSTRIALS	10.2	-1.5	11.8	-3.1	0.2	0.1	0.2
INFO TECHNOLOGY	20.5	7.4	15.2	1.8	1.2	0.0	1.2
MATERIALS	3.7	-12.2	3.2	-9.4	-0.1	-0.1	-0.2
TELECOM SERVICES	1.9	4.8	3.1	3.6	0.0	0.0	0.0
UTILITIES	1.8	6.2	3.1	9.3	-0.1	-0.1	-0.2
MISCELLANEOUS	0.9	2.6	0.0		0.0	0.0	0.0
	100.0%	3.1	100.0%	1.4	1.7	0.0	1.7

EQUITY ONLY BUY&HOLD RETURN (B)	3.1	STOCK SELECTION (E)	1.7
BENCHMARK BUY&HOLD RETURN (D)	1.4	SECTOR WEIGHTING (F)	0.0
TOTAL RELATIVE RETURN DIFFERENCE (B/D)	1.7	TOTAL SELECTION (E * F)	1.7
EQUITY ONLY ACTUAL RETURN (*)	3.3		
EQUITY ONLY BUY&HOLD RETURN (B)	3.1		
INTRA-PERIOD TRADING (* / B)	0.2		
TOTAL ACTIVE MANAGEMENT VALUE ADDED (SELECTION * TRADING)	1.9		

VERMONT MUNICIPAL EMPLOYEES
EQUITY PERFORMANCE ATTRIBUTION
QUARTER ENDING 6/05

DELAWARE

	PORTFOLIO		R 1000(R) VALUE		SELECTION		
	PCT OF BEGIN MKT VAL A	RATE OF RETURN B	PCT OF BEGIN MKT VAL C	RATE OF RETURN D	STOCK E	SECTOR F	TOTAL G
CONS DISCRETIONARY	7.8	-1.2	10.4	-2.1	0.1	0.1	0.2
CONSUMER STAPLES	9.1	-2.6	6.5	0.1	-0.2	0.0	-0.3
ENERGY	9.1	1.3	13.8	1.1	0.0	0.0	0.0
FINANCIALS	28.1	2.9	31.1	4.8	-0.5	-0.1	-0.6
HEALTH CARE	11.8	8.0	3.9	7.0	0.1	0.4	0.5
INDUSTRIALS	11.7	-1.6	12.5	-1.8	0.0	0.0	0.0
INFO TECHNOLOGY	7.1	8.2	5.4	-1.2	0.7	0.0	0.6
MATERIALS	6.0	-13.6	5.2	-8.2	-0.3	-0.1	-0.4
TELECOM SERVICES	4.4	4.9	4.9	2.5	0.1	0.0	0.1
UTILITIES	3.1	5.5	6.4	9.8	-0.1	-0.3	-0.4
MISCELLANEOUS	1.8	3.1	0.0		0.1	0.0	0.0
	100.0%	1.6	100.0%	1.7	-0.2	0.0	-0.2

EQUITY ONLY BUY&HOLD RETURN (B)	1.6	STOCK SELECTION (E)	-0.2
BENCHMARK BUY&HOLD RETURN (D)	1.7	SECTOR WEIGHTING (F)	0.0
TOTAL RELATIVE RETURN DIFFERENCE (B/D)	-0.2	TOTAL SELECTION (E * F)	-0.2
EQUITY ONLY ACTUAL RETURN (*)	1.3		
EQUITY ONLY BUY&HOLD RETURN (B)	1.6		
INTRA-PERIOD TRADING (* / B)	-0.2		
TOTAL ACTIVE MANAGEMENT VALUE ADDED (SELECTION * TRADING)	-0.4		

VERMONT MUNICIPAL EMPLOYEES
EQUITY PERFORMANCE ATTRIBUTION
QUARTER ENDING 6/05

ALLIANCE LARGE CAP GROWTH FUND

	PORTFOLIO		R 1000(R) GR		SELECTION		
	PCT OF BEGIN MKT VAL A	RATE OF RETURN B	PCT OF BEGIN MKT VAL C	RATE OF RETURN D	STOCK E	SECTOR F	TOTAL G
CONS DISCRETIONARY	16.2	0.4	14.3	1.8	-0.2	0.0	-0.3
CONSUMER STAPLES	5.9	-2.2	12.9	-0.6	-0.1	0.2	0.1
ENERGY	5.2	8.2	1.7	6.9	0.1	0.2	0.2
FINANCIALS	13.4	7.7	8.6	6.1	0.2	0.2	0.4
HEALTH CARE	16.5	8.2	24.5	4.6	0.6	-0.2	0.4
INDUSTRIALS	4.8	-5.7	9.3	-2.1	-0.2	0.2	0.0
INFO TECHNOLOGY	37.9	9.7	26.3	2.5	2.7	0.0	2.7
MATERIALS	0.0		1.3	-7.5	0.0	0.1	0.1
TELECOM SERVICES	0.0		1.0	12.7	0.0	-0.1	-0.1
UTILITIES	0.0		0.2	1.0	0.0	0.0	0.0
MISCELLANEOUS	0.0		0.0				
	100.0%	6.1	100.0%	2.4	3.0	0.6	3.6

EQUITY ONLY BUY&HOLD RETURN (B)	6.1	STOCK SELECTION (E)	3.0
BENCHMARK BUY&HOLD RETURN (D)	2.4	SECTOR WEIGHTING (F)	0.6
TOTAL RELATIVE RETURN DIFFERENCE (B/D)	3.6	TOTAL SELECTION (E * F)	3.6
EQUITY ONLY ACTUAL RETURN (*)	6.4		
EQUITY ONLY BUY&HOLD RETURN (B)	6.1		
INTRA-PERIOD TRADING (* / B)	0.3		
TOTAL ACTIVE MANAGEMENT VALUE ADDED (SELECTION * TRADING)	3.9		

VERMONT MUNICIPAL EMPLOYEES
EQUITY PERFORMANCE ATTRIBUTION
QUARTER ENDING 6/05

LAZARD SMALL CAP FUND

	PORTFOLIO		R 2000(R)		SELECTION		
	PCT OF BEGIN MKT VAL A	RATE OF RETURN B	PCT OF BEGIN MKT VAL C	RATE OF RETURN D	STOCK E	SECTOR F	TOTAL G
CONS DISCRETIONARY	17.4	0.7	15.2	5.1	-0.7	0.0	-0.7
CONSUMER STAPLES	1.7	-0.3	2.9	5.2	-0.1	0.0	-0.1
ENERGY	10.4	2.7	6.6	7.5	-0.5	0.1	-0.4
FINANCIALS	18.3	7.6	21.5	8.1	-0.1	-0.1	-0.2
HEALTH CARE	10.3	-3.3	11.8	8.7	-1.2	-0.1	-1.3
INDUSTRIALS	15.8	0.7	14.6	1.7	-0.2	0.0	-0.2
INFO TECHNOLOGY	17.4	-0.5	16.4	1.2	-0.3	0.0	-0.3
MATERIALS	5.4	-9.4	6.5	-8.6	0.0	0.1	0.1
TELECOM SERVICES	0.4	1.3	1.1	9.1	0.0	0.0	-0.1
UTILITIES	2.3	7.8	3.6	8.2	0.0	0.0	0.0
MISCELLANEOUS	0.8	0.7	0.0		0.0	0.0	0.0
	100.0%	1.2	100.0%	4.4	-3.1	-0.1	-3.1

EQUITY ONLY BUY&HOLD RETURN (B)	1.2	STOCK SELECTION (E)	-3.1
BENCHMARK BUY&HOLD RETURN (D)	4.4	SECTOR WEIGHTING (F)	-0.1
TOTAL RELATIVE RETURN DIFFERENCE (B/D)	-3.1	TOTAL SELECTION (E * F)	-3.1
EQUITY ONLY ACTUAL RETURN (*)	2.0		
EQUITY ONLY BUY&HOLD RETURN (B)	1.2		
INTRA-PERIOD TRADING (* / B)	0.8		
TOTAL ACTIVE MANAGEMENT VALUE ADDED (SELECTION * TRADING)	-2.4		

VERMONT MUNICIPAL EMPLOYEES
HISTORICAL EQUITY ATTRIBUTION
PERIODS ENDING 6/05

MUNICIPAL SYSTEM COMPOSITE

	EQUITY ONLY BUY&HOLD RETURN	BENCHMARK RETURN	STOCK	SECTOR	TOTAL	SELECTION IMPACT	INTRA MONTH TRADING	TOTAL VALUE ADDED
LAST QTR	3.1	1.4	1.7	0.0	1.7	1.7	0.2	1.9
LAST 2 QTRS	-0.2	-0.8	1.3	-0.7	0.6	0.6	0.2	0.8
LAST 3 QTRS	8.9	8.3	1.1	-0.5	0.6	0.6	0.7	1.3
LAST YEAR	5.6	6.3	0.5	-1.1	-0.6	-0.6	0.5	-0.1
LAST 2 YEARS	12.7	12.5	0.6	-0.5	0.2	0.2	0.9	1.1
LAST 3 YEARS	6.9	8.3	-0.9	-0.4	-1.3	-1.3	0.8	-0.5
LAST 4 YEARS	2.5	1.1	1.2	0.3	1.4	1.4	0.8	2.2
LAST 5 YEARS								
YEAR ENDING 12/04	9.5	10.8	-0.6	-0.6	-1.2	-1.2	1.2	0.0
YEAR ENDING 12/03	30.3	28.6	0.7	0.6	1.3	1.3	0.3	1.6

BENCHMARK: S&P 500

VERMONT MUNICIPAL EMPLOYEES
HISTORICAL EQUITY ATTRIBUTION
PERIODS ENDING 6/05

DOMESTIC EQUITY COMPOSITE

	EQUITY ONLY BUY&HOLD RETURN	BENCHMARK RETURN	STOCK	SECTOR	TOTAL	SELECTION IMPACT	INTRA MONTH TRADING	TOTAL VALUE ADDED
LAST QTR	3.1	1.4	1.7	0.0	1.7	1.7	0.2	1.9
LAST 2 QTRS	-0.2	-0.8	1.3	-0.7	0.6	0.6	0.2	0.8
LAST 3 QTRS	8.9	8.3	1.1	-0.5	0.6	0.6	0.7	1.3
LAST YEAR	5.6	6.3	0.5	-1.1	-0.6	-0.6	0.5	-0.1
LAST 2 YEARS	12.7	12.5	0.6	-0.5	0.2	0.2	0.9	1.1
LAST 3 YEARS	6.9	8.3	-0.9	-0.4	-1.3	-1.3	0.8	-0.5
LAST 4 YEARS	2.5	1.1	1.2	0.3	1.4	1.4	0.8	2.2
LAST 5 YEARS								
YEAR ENDING 12/04	9.5	10.8	-0.6	-0.6	-1.2	-1.2	1.2	0.0
YEAR ENDING 12/03	30.3	28.6	0.7	0.6	1.3	1.3	0.3	1.6

BENCHMARK: S&P 500

VERMONT MUNICIPAL EMPLOYEES
HISTORICAL EQUITY ATTRIBUTION
PERIODS ENDING 6/05

DELAWARE

	EQUITY ONLY BUY&HOLD RETURN	BENCHMARK RETURN	STOCK	SECTOR	TOTAL	SELECTION IMPACT	INTRA MONTH TRADING	TOTAL VALUE ADDED
LAST QTR	1.6	1.7	-0.2	0.0	-0.2	-0.2	-0.2	-0.4
LAST 2 QTRS	0.9	1.8	-0.5	-0.4	-0.9	-0.9	-0.9	-1.7
LAST 3 QTRS	9.5	12.3	-2.9	0.4	-2.5	-2.5	-0.7	-3.1
LAST YEAR	8.6	14.1	-3.5	-1.2	-4.7	-4.7	-1.0	-5.7
LAST 2 YEARS	13.8	17.5	-2.5	-0.6	-3.2	-3.2	-0.1	-3.3
LAST 3 YEARS	8.4	10.5	-1.4	-0.6	-1.9	-1.9	-0.1	-2.0
LAST 4 YEARS	4.9	2.5	0.9	1.4	2.3	2.3	-0.4	1.9
LAST 5 YEARS								
YEAR ENDING 12/04	11.0	16.4	-4.0	-0.6	-4.6	-4.6	0.4	-4.2
YEAR ENDING 12/03	29.9	30.0	0.2	-0.3	-0.1	-0.1	-0.3	-0.4

BENCHMARK: R 1000(R) VALUE

VERMONT MUNICIPAL EMPLOYEES
HISTORICAL EQUITY ATTRIBUTION
PERIODS ENDING 6/05

ALLIANCE LARGE CAP GROWTH FUND

	EQUITY ONLY BUY&HOLD RETURN	BENCHMARK RETURN	STOCK	SECTOR	TOTAL	SELECTION IMPACT	INTRA MONTH TRADING	TOTAL VALUE ADDED
LAST QTR	6.1	2.4	3.0	0.6	3.6	3.6	0.3	3.9
LAST 2 QTRS	-1.3	-1.8	1.0	-0.5	0.5	0.5	1.1	1.6
LAST 3 QTRS	7.5	7.2	0.5	-0.2	0.3	0.3	1.4	1.8
LAST YEAR	1.7	1.6	1.0	-0.9	0.1	0.1	1.1	1.2
LAST 2 YEARS	8.1	9.5	-0.5	-0.7	-1.2	-1.2	1.4	0.2
LAST 3 YEARS	3.9	7.3	-2.3	-0.8	-3.1	-3.1	1.4	-1.8
LAST 4 YEARS	-3.8	-2.4	-1.3	-0.1	-1.4	-1.4	1.7	0.3
LAST 5 YEARS								
YEAR ENDING 12/04	5.0	6.4	-0.1	-1.3	-1.3	-1.3	1.5	0.1
YEAR ENDING 12/03	26.1	29.7	-2.4	-0.4	-2.8	-2.8	0.0	-2.8

BENCHMARK: R 1000(R) GR

VERMONT MUNICIPAL EMPLOYEES
HISTORICAL EQUITY ATTRIBUTION
PERIODS ENDING 6/05

LAZARD SMALL CAP FUND

	EQUITY ONLY BUY&HOLD RETURN	BENCHMARK RETURN	STOCK	SECTOR	TOTAL	SELECTION IMPACT	INTRA MONTH TRADING	TOTAL VALUE ADDED
LAST QTR	1.2	4.4	-3.1	-0.1	-3.1	-3.1	0.8	-2.4
LAST 2 QTRS	-0.3	-1.2	0.1	0.7	0.8	0.8	0.5	1.3
LAST 3 QTRS	10.2	12.8	-2.9	0.6	-2.3	-2.3	1.7	-0.6
LAST YEAR	6.7	9.7	-3.8	1.1	-2.7	-2.7	2.2	-0.6
LAST 2 YEARS	18.7	21.1	-2.8	0.8	-2.0	-2.0	1.3	-0.7
LAST 3 YEARS	9.8	13.0	-2.7	-0.1	-2.8	-2.8	1.4	-1.5
LAST 4 YEARS	8.2	7.2	1.4	-0.4	1.0	1.0	1.5	2.4
LAST 5 YEARS								
YEAR ENDING 12/04	14.1	18.7	-4.8	1.0	-3.9	-3.9	1.8	-2.2
YEAR ENDING 12/03	39.4	47.0	-4.2	-1.0	-5.2	-5.2	0.4	-4.8

BENCHMARK: R 2000(R)

VERMONT MUNICIPAL EMPLOYEES

EQUITY ONLY - RATES OF RETURN

COMPARED TO FUNDS WITH SIMILAR BETA

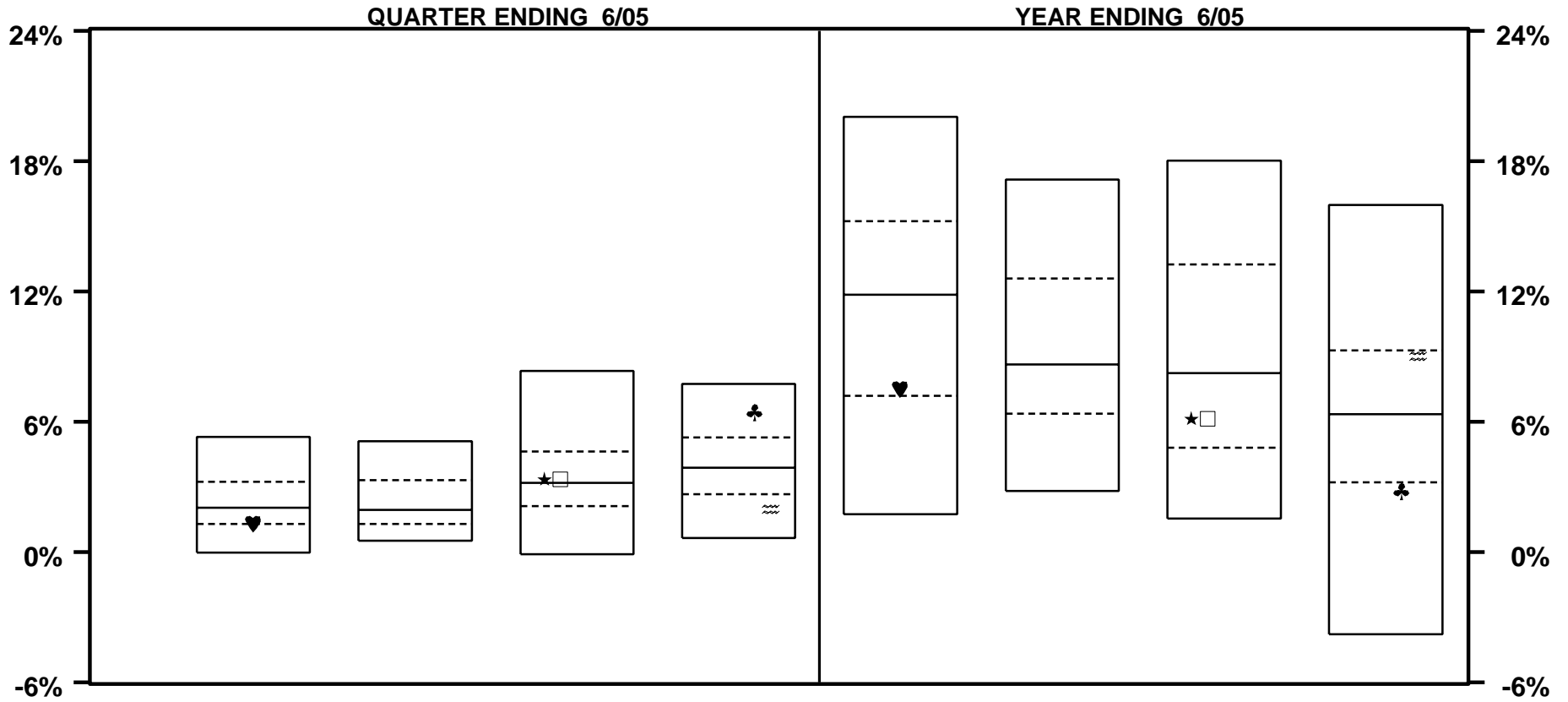

	QUARTER ENDING 6/05			YEAR ENDING 6/05				
	BELOW 1.0	1.0-1.1	1.1-1.2	ABOVE 1.2	BELOW 1.0	1.0-1.1	1.1-1.2	ABOVE 1.2
★ MUNI COMPOSITE			3.3 47				6.2 63	
□ EQTY COMPOSITE			3.3 47				6.2 63	
♥ DELAWARE	1.3 74				7.5 72			
♣ ALLIANCE				6.4 11				2.8 77
≡ LAZARD				2.0 84				9.0 26
MEDIAN	2.0	1.9	3.2	3.9	11.8	8.6	8.2	6.4

VERMONT MUNICIPAL EMPLOYEES

EQUITY ONLY - RATES OF RETURN

COMPARED TO FUNDS WITH SIMILAR DIVERSIFICATION

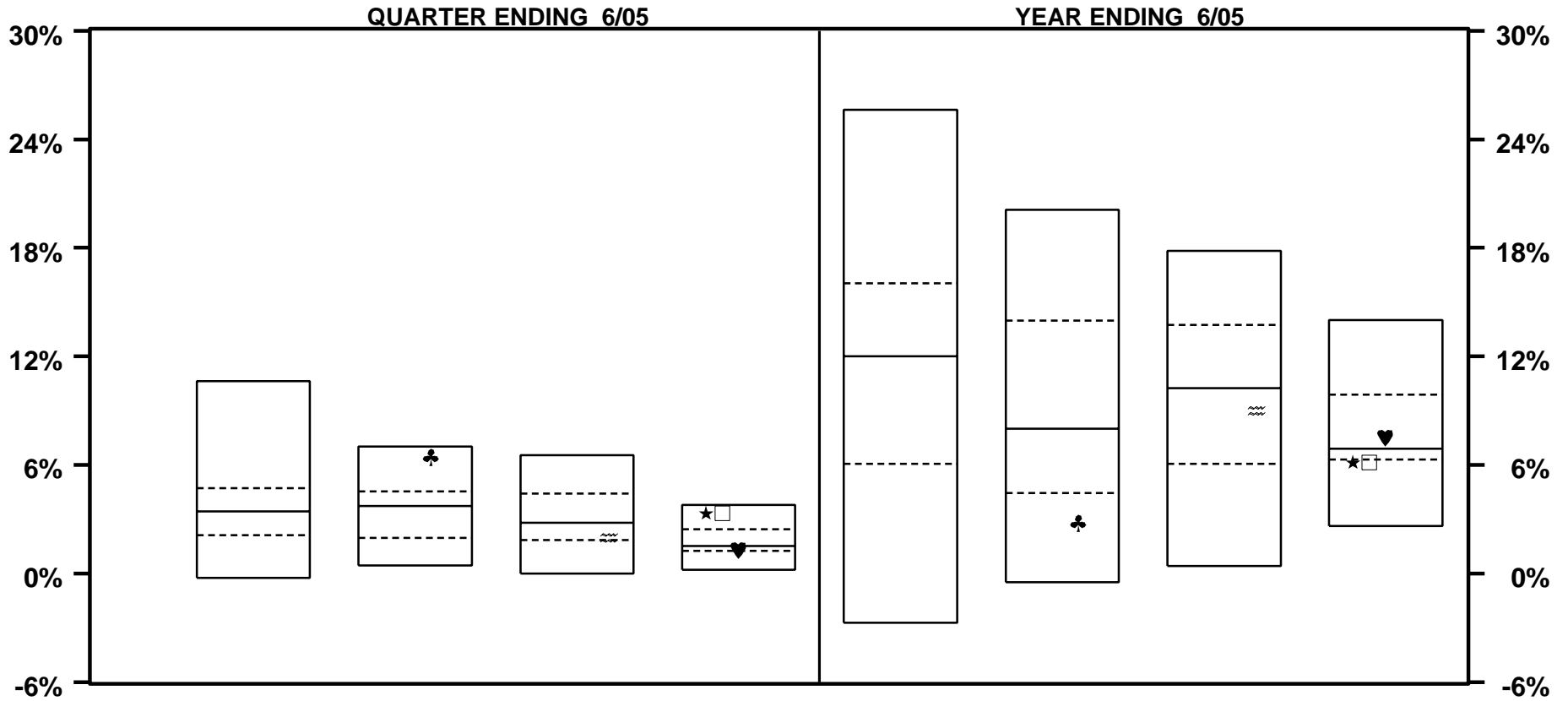

	BELOW 0.85	0.85- 0.90	0.90- 0.95	ABOVE 0.95	BELOW 0.85	0.85- 0.90	0.90- 0.95	ABOVE 0.95
★ MUNI COMPOSITE				3.3 9				6.2 80
□ EQTY COMPOSITE				3.3 9				6.2 80
♥ DELAWARE				1.3 73				7.5 44
♣ ALLIANCE		6.4 8				2.8 84		
≈ LAZARD			2.0 72				9.0 56	
MEDIAN	3.4	3.7	2.8	1.5	12.0	8.0	10.2	6.9

VERMONT MUNICIPAL EMPLOYEES

EQUITY ONLY - RATES OF RETURN

COMPARED TO FUNDS WITH SIMILAR P/E RATIO

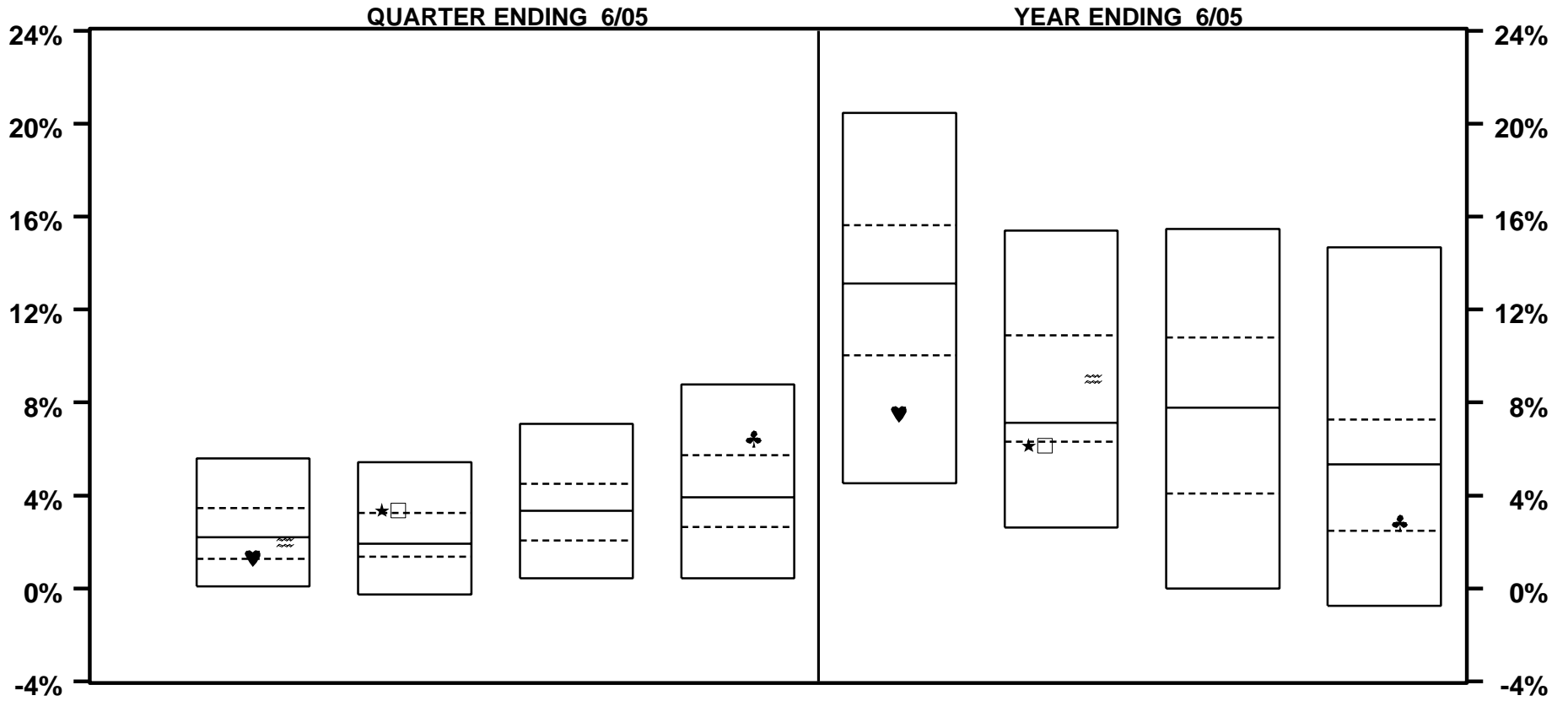

	QUARTER ENDING 6/05				YEAR ENDING 6/05			
	BELOW 17.5	17.5- 20.0	20.0- 22.5	ABOVE 22.5	BELOW 17.5	17.5- 20.0	20.0- 22.5	ABOVE 22.5
★ MUNI COMPOSITE		3.3				6.2		
□ EQTY COMPOSITE		3.3				6.2		
♥ DELAWARE	1.3				7.5			
♣ ALLIANCE				6.4				2.8
≡ LAZARD	2.0					9.0		
MEDIAN	2.2	1.9	3.3	3.9	13.1	7.1	7.8	5.3

VERMONT MUNICIPAL EMPLOYEES

EQUITY STYLE SPECTRUM METHODOLOGY

Background:

Equity Style Spectrum analysis is employed in characterizing the investment approach of a managed equity portfolio. It further provides the means for grouping equity portfolios with similar investment styles. While no rule-based methodology can claim to capture all of the decisions made by an investment manager, the size of the firm in which a manager invests and the fundamental growth or value orientation of portfolio constituent holdings serve to explain a significant portion of fund performance.

Exhibits:

The intersection of Size (Y-axis) and Value/Growth (X-axis) coordinates drive equity style spectrum mappings on a nine-quadrant grid. Each of the nine quadrants is bounded by both a metric of size and a measure of value, growth or neutrality. The style map depicts the magnitude of an individual manager's style bias while similarly identifying style gaps and redundancies among multiple investment managers. As style bias is characterized at points in time over extended intervals, the style map similarly captures any "style drift" that may be exhibited.

While portfolio-level assignments are driven by a weighted-average calculation of constituent holding size and value/growth scores, the portfolio cross-sectional distribution of such scores is of additional interest. Consider, for example, that a Mid Cap assignment can result from holding either a portfolio that is concentrated exclusively in mid cap stocks or alternatively as a result of holding both large and small cap names. Similarly, a Core assignment can be accorded to a portfolio that is wholly comprised of constituent holdings that have no style bias (neutral) or equivalently by holding securities that carry both a growth and value bias in equal proportion.

Methodology:

Size scores for constituent holdings are identically the risk index exposure values for Size as obtained from BARRA's US-E3 Equity Risk Model. The log of market capitalization is, in turn, employed in deriving the risk index exposure value.

The Value/Growth score associated with a given portfolio is derived by way of a probabilistic assesment of the tendency toward value and growth exhibited by its constituent portfolio holdings. Value is characterized through an aggregation of BARRA US-E3 risk index exposures to Earnings Yield, Book/Price ratio and Dividend Yield, respectively. Growth is assessed through a consideration of exposure to the US-E3 Growth index.

Size quadrants are bounded per:

Small: Size Exposure < -1.90
Mid: -1.90 <= Size Exposure <= -1.00
Large: Size Exposure > -1.00

Value/Growth quadrants are bounded per:

Value: Value/Growth Exposure < -0.15
Core: -0.15 <= Value/Growth Exposure <= 0.15
Growth: Value/Growth Exposure > 0.15

VERMONT MUNICIPAL EMPLOYEES

EQUITY MANAGER SPECTRUM STYLE ANALYSIS - TOTAL RETURNS

QUARTER ENDING 6/05

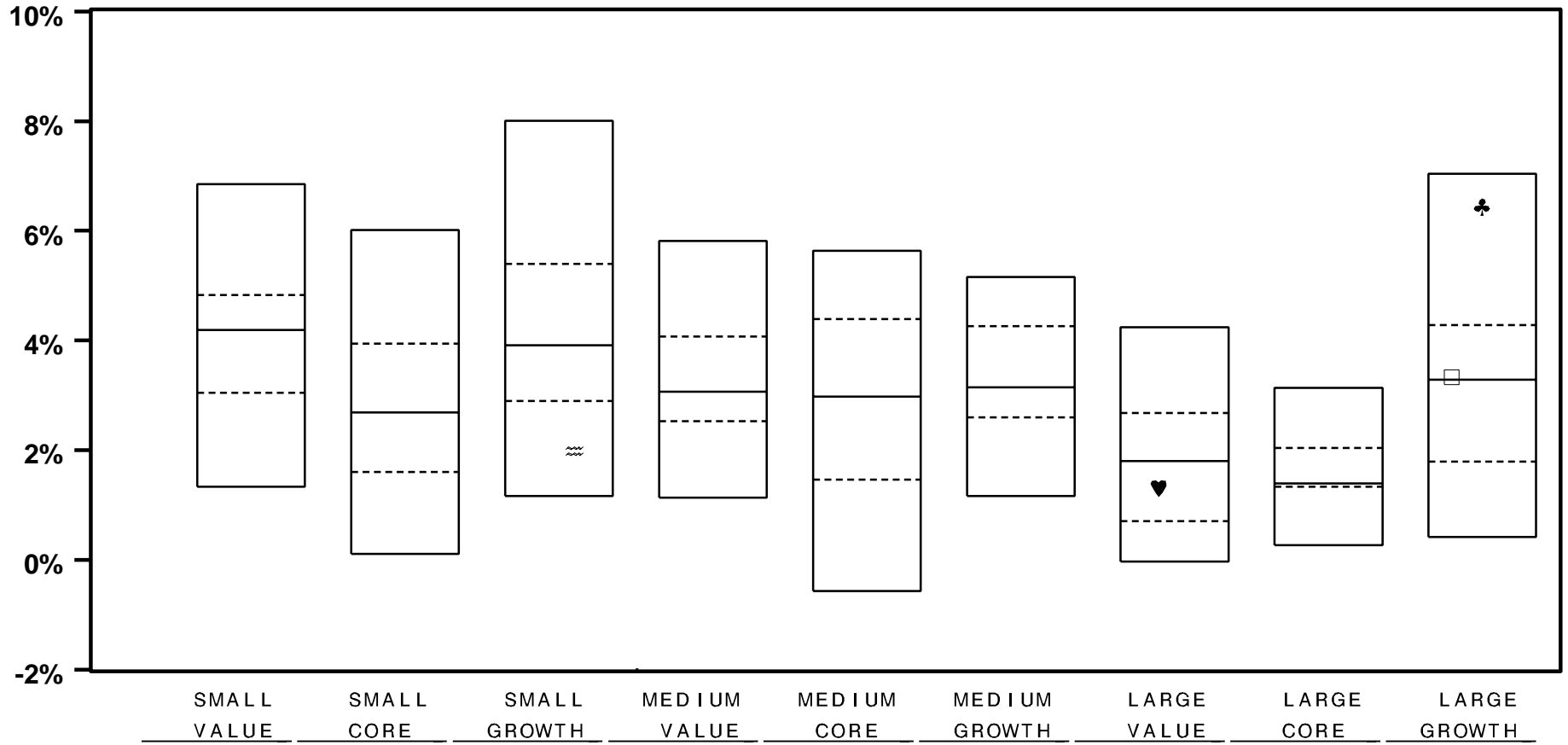

- EQTY COMPOSITE
- ♥ DELAWARE
- ♣ ALLIANCE
- ≈ LAZARD

3.3 49
1.3 62

2.0 87

MEDIAN 4.2 2.7 3.9 3.1 3.0 3.1 1.8 1.4 3.3

VERMONT MUNICIPAL EMPLOYEES

EQUITY MANAGER SPECTRUM STYLE ANALYSIS - TOTAL RETURNS

YEAR ENDING 6/05

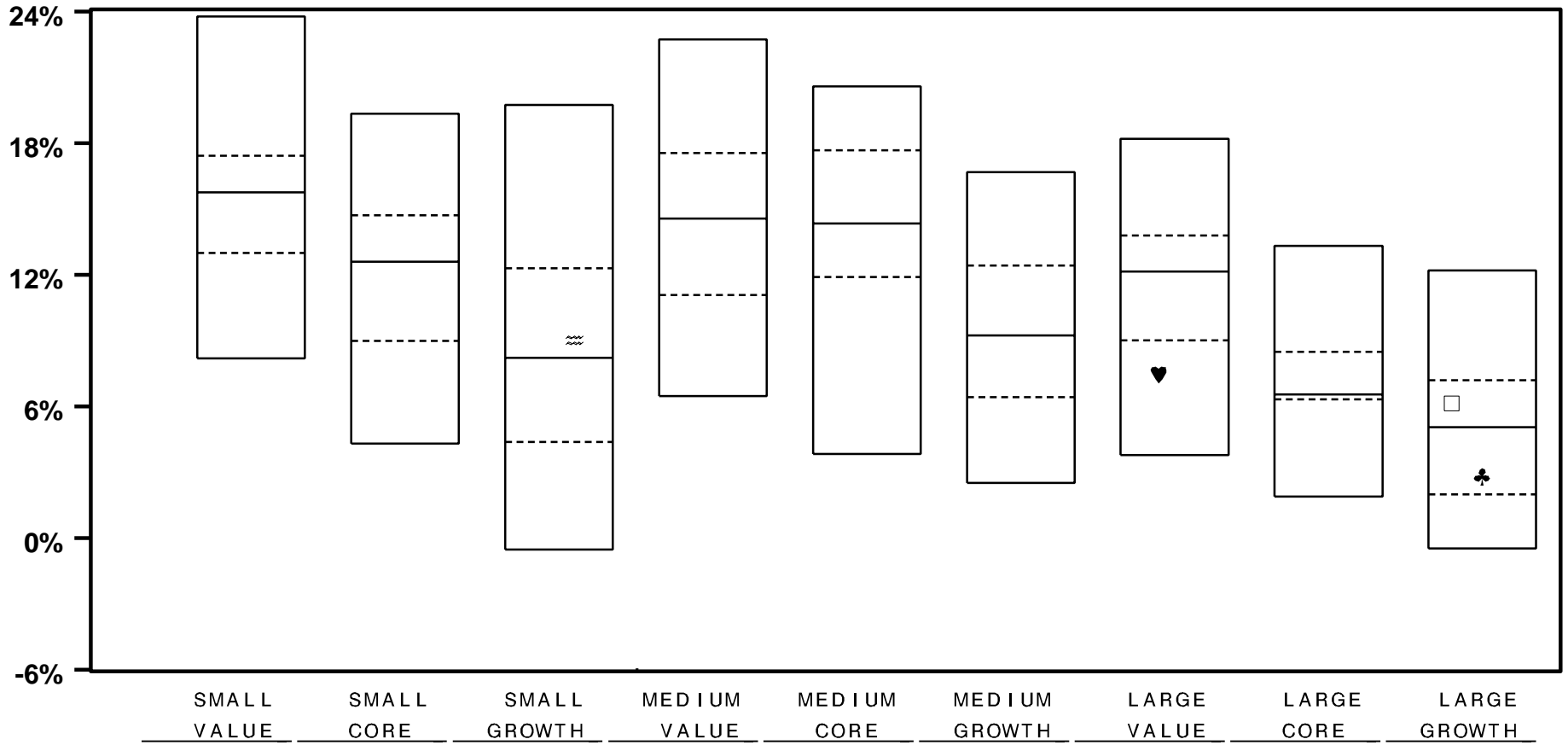

	SMALL VALUE	SMALL CORE	SMALL GROWTH	MEDIUM VALUE	MEDIUM CORE	MEDIUM GROWTH	LARGE VALUE	LARGE CORE	LARGE GROWTH
EQTY COMPOSITE									6.1 37
DELAWARE							7.5 81		
ALLIANCE									2.8 66
LAZARD			9.0 46						
MEDIAN	15.8	12.6	8.2	14.6	14.3	9.2	12.2	6.5	5.0

VERMONT MUNICIPAL EMPLOYEES

EQUITY MANAGER SPECTRUM STYLE ANALYSIS - TOTAL RETURNS

TWO YEARS ENDING 6/05

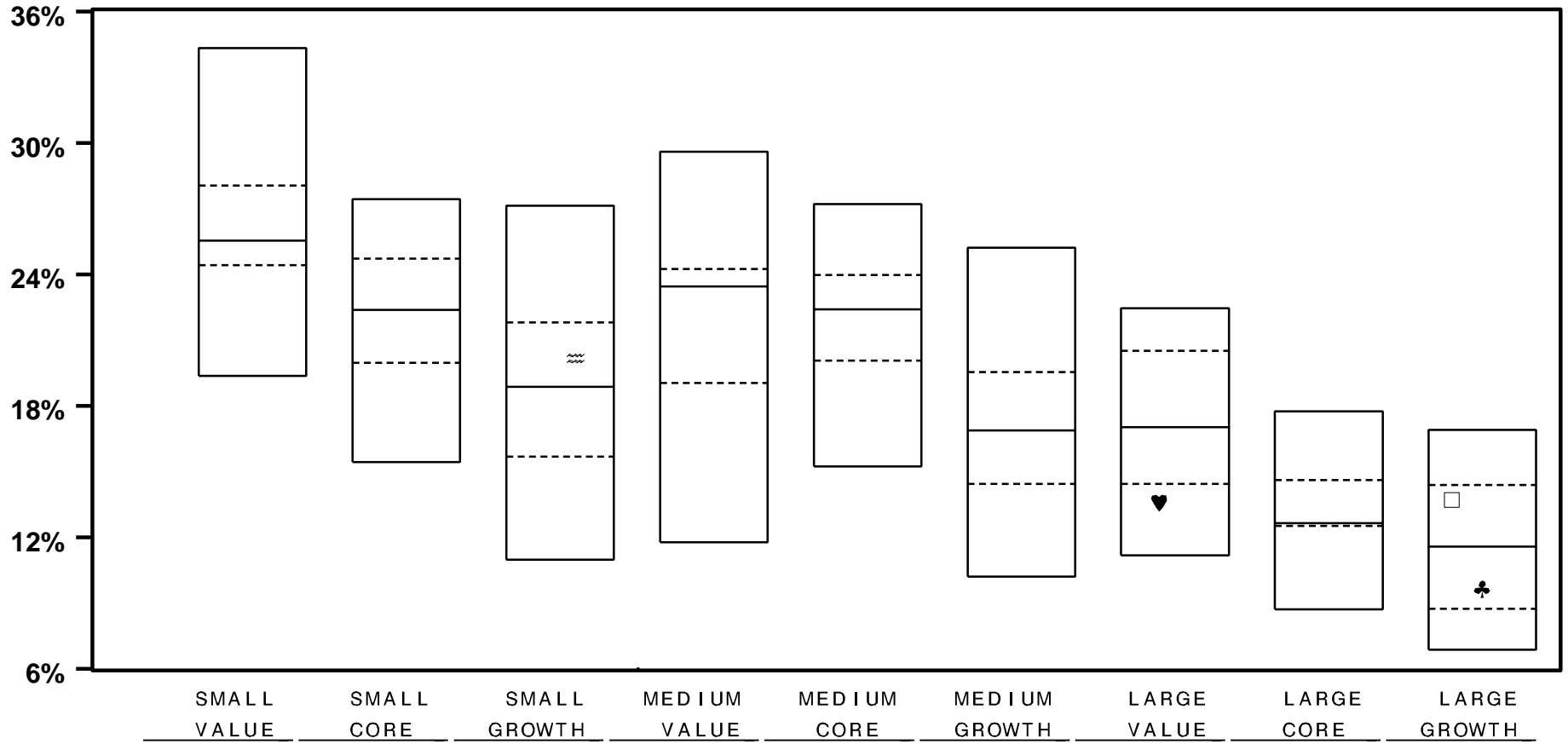

	SMALL VALUE	SMALL CORE	SMALL GROWTH	MEDIUM VALUE	MEDIUM CORE	MEDIUM GROWTH	LARGE VALUE	LARGE CORE	LARGE GROWTH
EQTY COMPOSITE									13.7 33
DELAWARE							13.6 81		
ALLIANCE									9.7 66
LAZARD			20.2 37						
MEDIAN	25.5	22.4	18.9	23.4	22.4	16.9	17.0	12.6	11.6

VERMONT MUNICIPAL EMPLOYEES

EQUITY MANAGER SPECTRUM STYLE ANALYSIS - TOTAL RETURNS

THREE YEARS ENDING 6/05

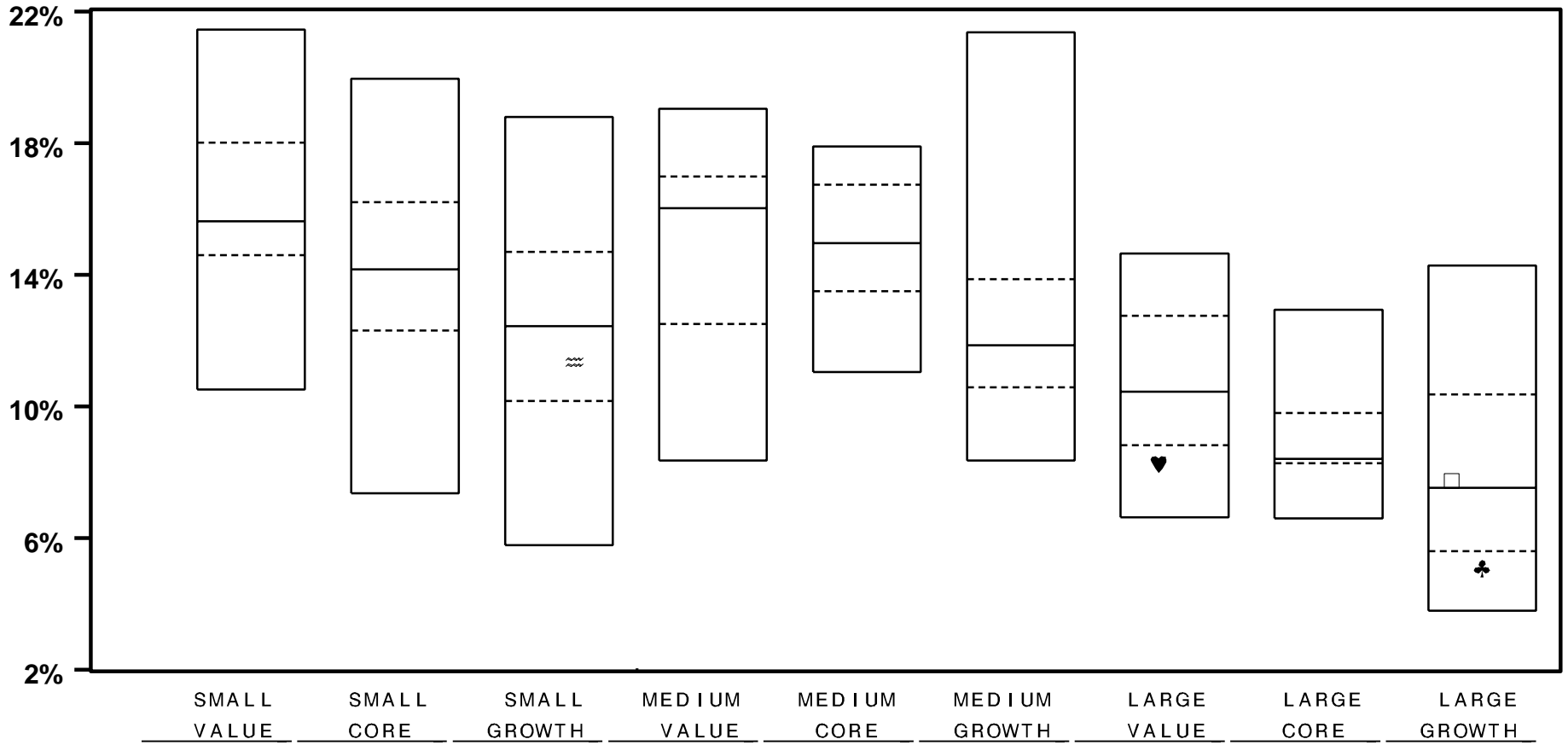

- EQTY COMPOSITE
- ♥ DELAWARE
- ♣ ALLIANCE
- ≡ LAZARD

8.2 82

11.4 63

7.7 46

5.1 84

MEDIAN	15.6	14.2	12.4	16.0	15.0	11.9	10.5	8.4	7.5
---------------	------	------	------	------	------	------	------	-----	-----

VERMONT MUNICIPAL EMPLOYEES

EQUITY MANAGER SPECTRUM STYLE ANALYSIS - TOTAL RETURNS

FOUR YEARS ENDING 6/05

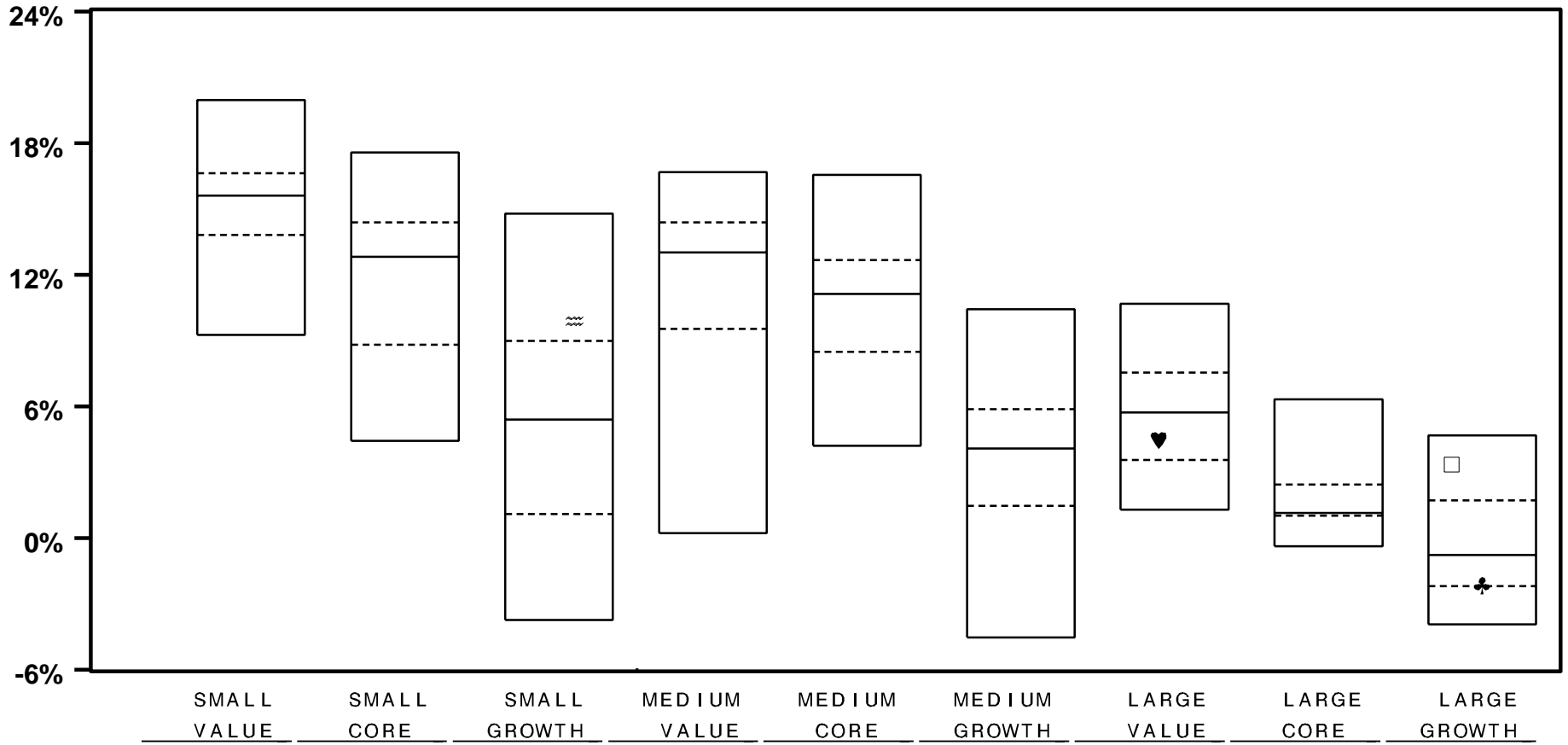

□ EQTY COMPOSITE									3.4	13
♥ DELAWARE							4.5	67		
♣ ALLIANCE									-2.1	74
≡ LAZARD			9.9	16						
MEDIAN	15.6	12.8	5.4	13.0	11.1	4.1	5.7	1.1	-0.8	

VERMONT MUNICIPAL EMPLOYEES

EQUITY MANAGER SPECTRUM STYLE ANALYSIS - TOTAL RETURNS

FIVE YEARS ENDING 6/05

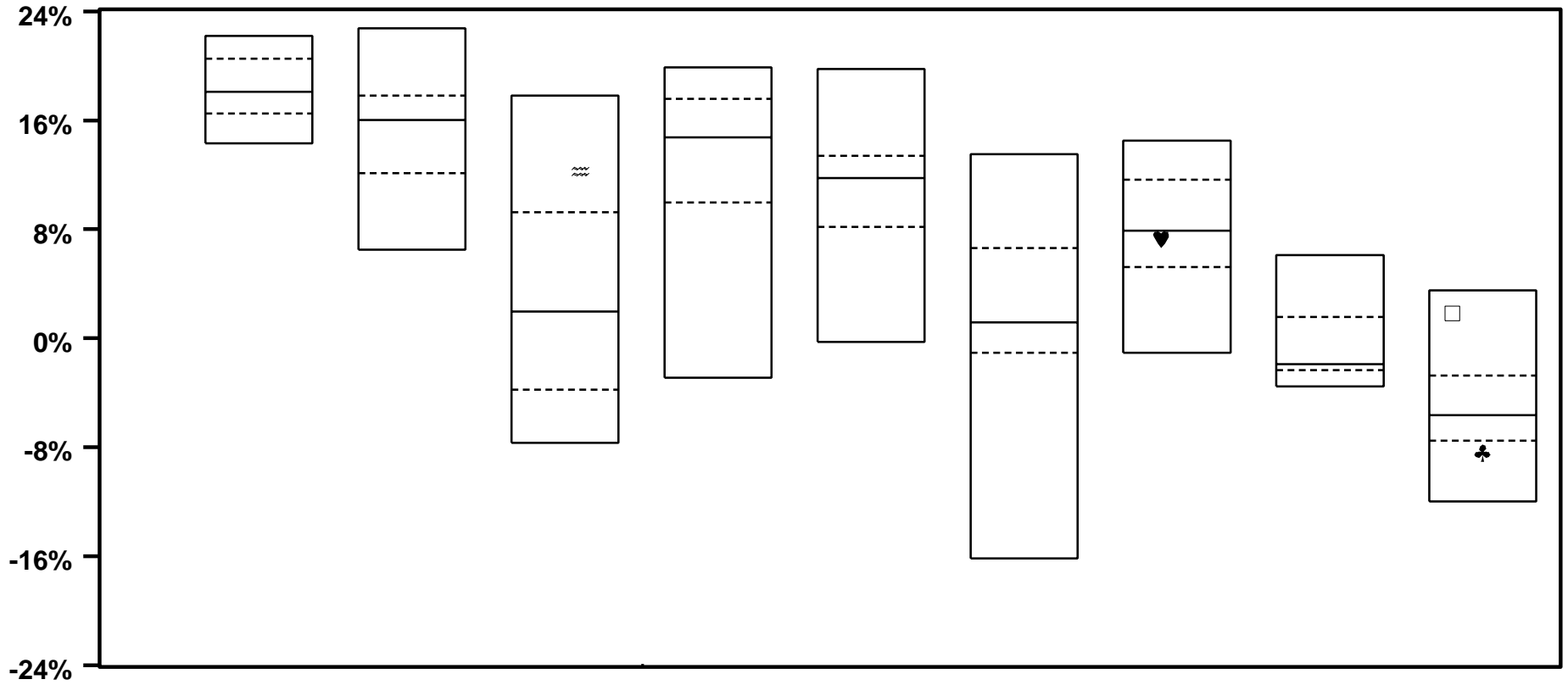

	SMALL VALUE	SMALL CORE	SMALL GROWTH	MEDIUM VALUE	MEDIUM CORE	MEDIUM GROWTH	LARGE VALUE	LARGE CORE	LARGE GROWTH
EQTY COMPOSITE									1.8 9
DELAWARE							7.3 56		
ALLIANCE									-8.4 83
LAZARD			12.3 17						
MEDIAN	18.1	16.0	2.0	14.7	11.8	1.2	7.9	-1.9	-5.7

VERMONT MUNICIPAL EMPLOYEES

EQUITY MANAGER SPECTRUM STYLE ANALYSIS - TOTAL RETURNS

YEAR ENDING 6/04

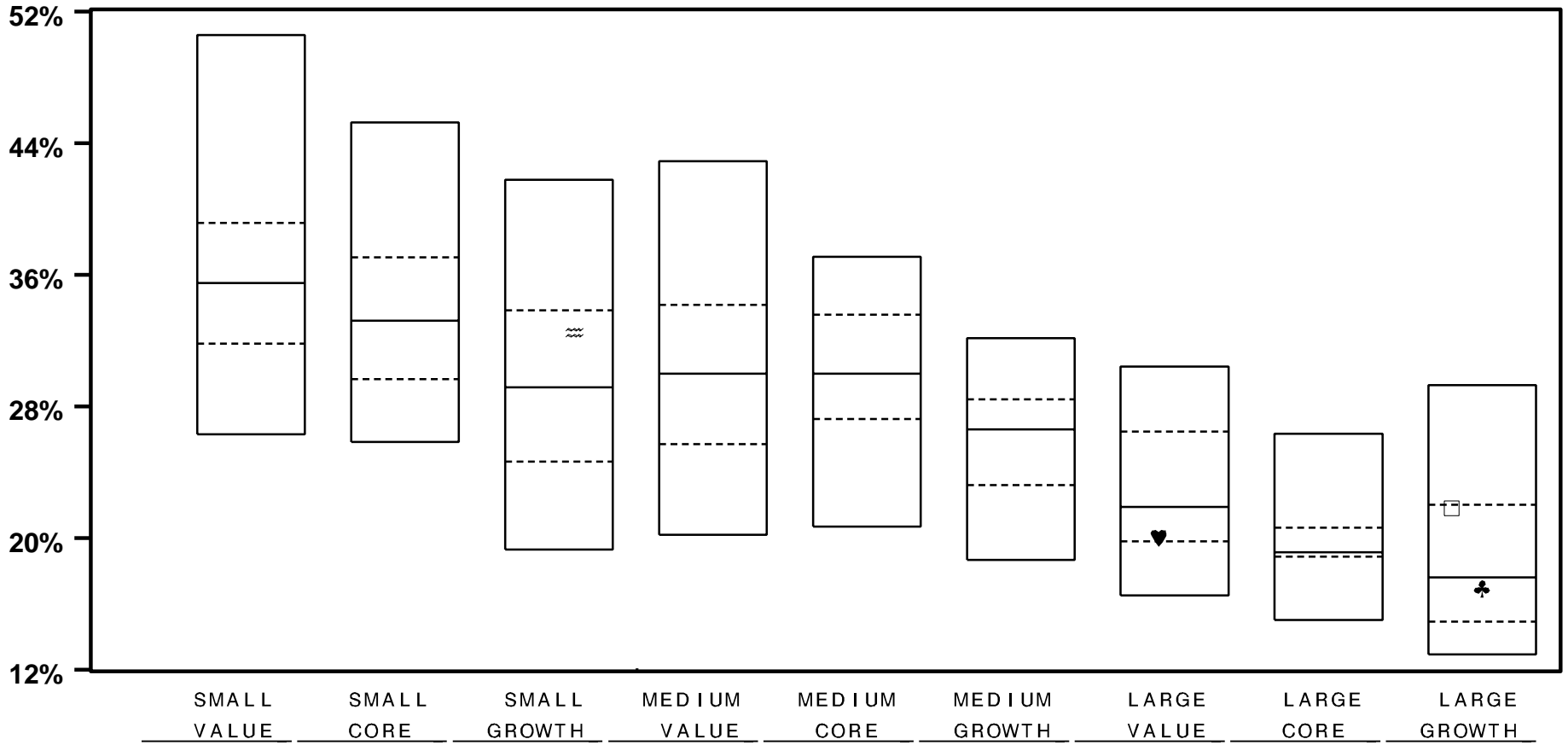

- EQTY COMPOSITE
- ♥ DELAWARE
- ♣ ALLIANCE
- ≈ LAZARD

									21.8	26
							20.0	70		
			32.5	31					16.9	55
MEDIAN	35.5	33.2	29.1	30.0	30.0	26.6	21.9	19.1	17.6	

VERMONT MUNICIPAL EMPLOYEES

EQUITY MANAGER SPECTRUM STYLE ANALYSIS - TOTAL RETURNS

YEAR ENDING 6/03

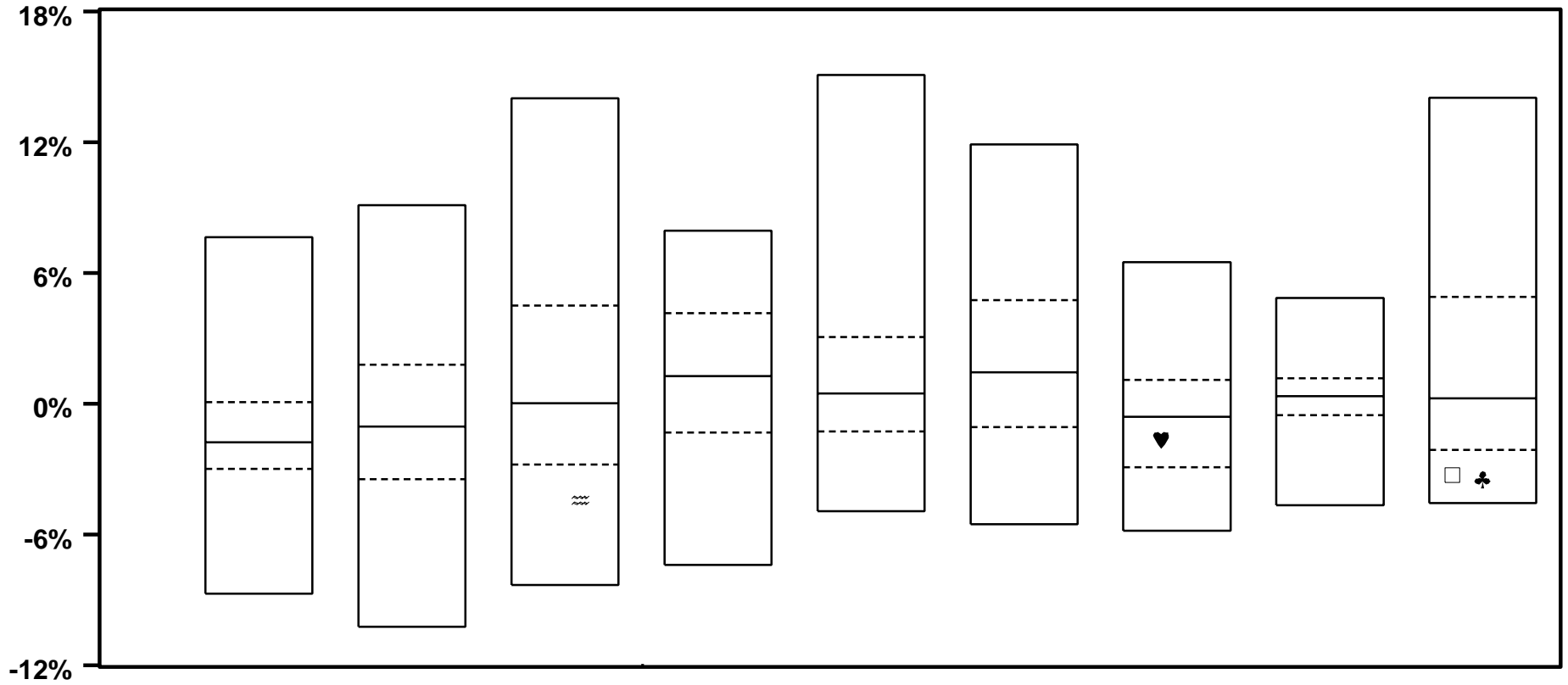

	SMALL VALUE	SMALL CORE	SMALL GROWTH	MEDIUM VALUE	MEDIUM CORE	MEDIUM GROWTH	LARGE VALUE	LARGE CORE	LARGE GROWTH
EQTY COMPOSITE									- 3.3 87
DELAWARE							- 1.7 64		
ALLIANCE									- 3.5 89
LAZARD			- 4.4 80						
MEDIAN	- 1.8	- 1.1	0.0	1.3	0.5	1.4	- 0.6	0.4	0.2

VERMONT MUNICIPAL EMPLOYEES

EQUITY MANAGER SPECTRUM STYLE ANALYSIS - TOTAL RETURNS

YEAR ENDING 6/02

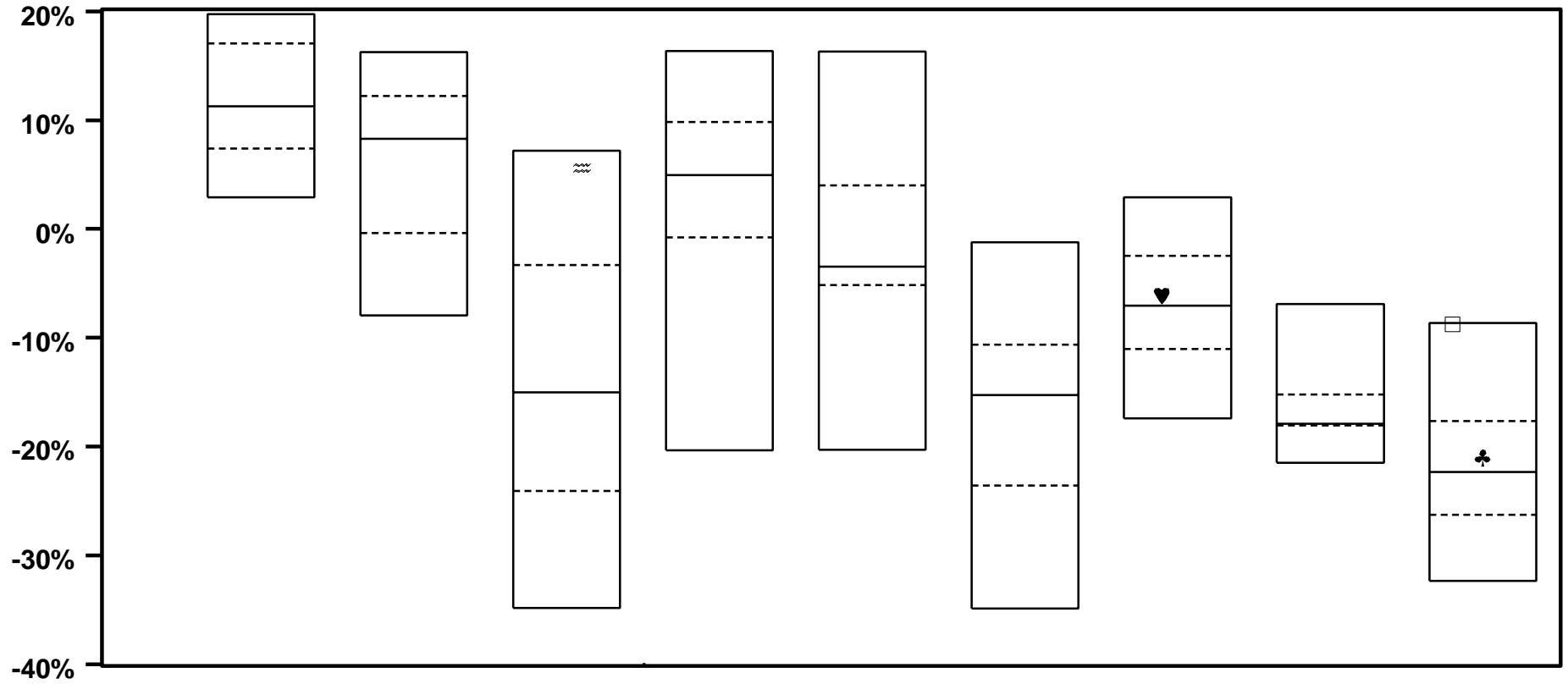

	SMALL VALUE	SMALL CORE	SMALL GROWTH	MEDIUM VALUE	MEDIUM CORE	MEDIUM GROWTH	LARGE VALUE	LARGE CORE	LARGE GROWTH
EQTY COMPOSITE									- 8.7 5
DELAWARE							- 6.1 44		
ALLIANCE									- 21.0 41
LAZARD			5.6 8						
MEDIAN	11.3	8.3	- 15.0	5.0	- 3.5	- 15.3	- 7.1	- 17.9	- 22.4

VERMONT MUNICIPAL EMPLOYEES

EQUITY MANAGER SPECTRUM STYLE ANALYSIS - TOTAL RETURNS

YEAR ENDING 6/01

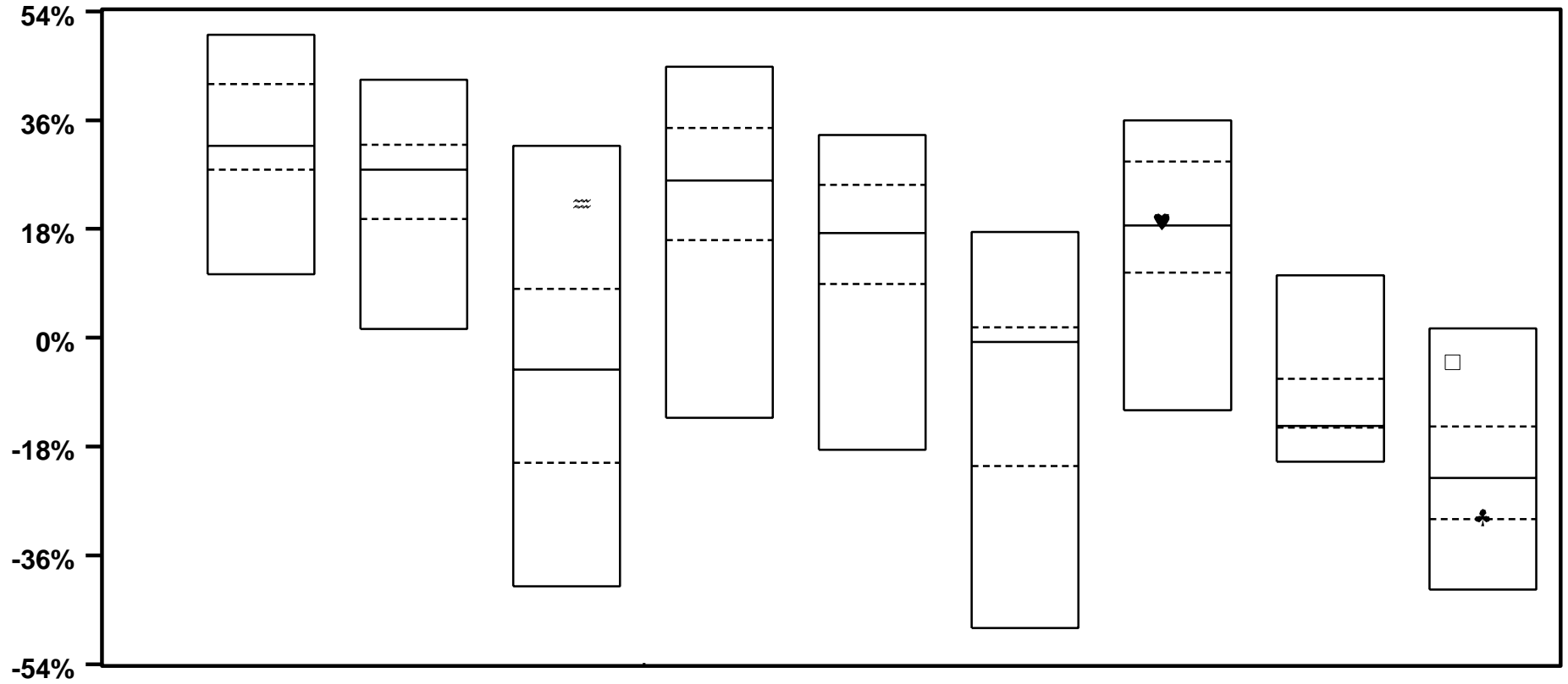

	SMALL VALUE	SMALL CORE	SMALL GROWTH	MEDIUM VALUE	MEDIUM CORE	MEDIUM GROWTH	LARGE VALUE	LARGE CORE	LARGE GROWTH
EQTY COMPOSITE									- 4.1 7
DELAWARE							19.3 49		- 29.6 73
ALLIANCE									
LAZARD			22.2 13						
MEDIAN	31.7	27.8	- 5.3	26.0	17.3	- 0.7	18.6	- 14.6	- 23.2

VERMONT MUNICIPAL EMPLOYEES

EQUITY MANAGER SPECTRUM STYLE ANALYSIS - TOTAL RETURNS

YEAR ENDING 6/00

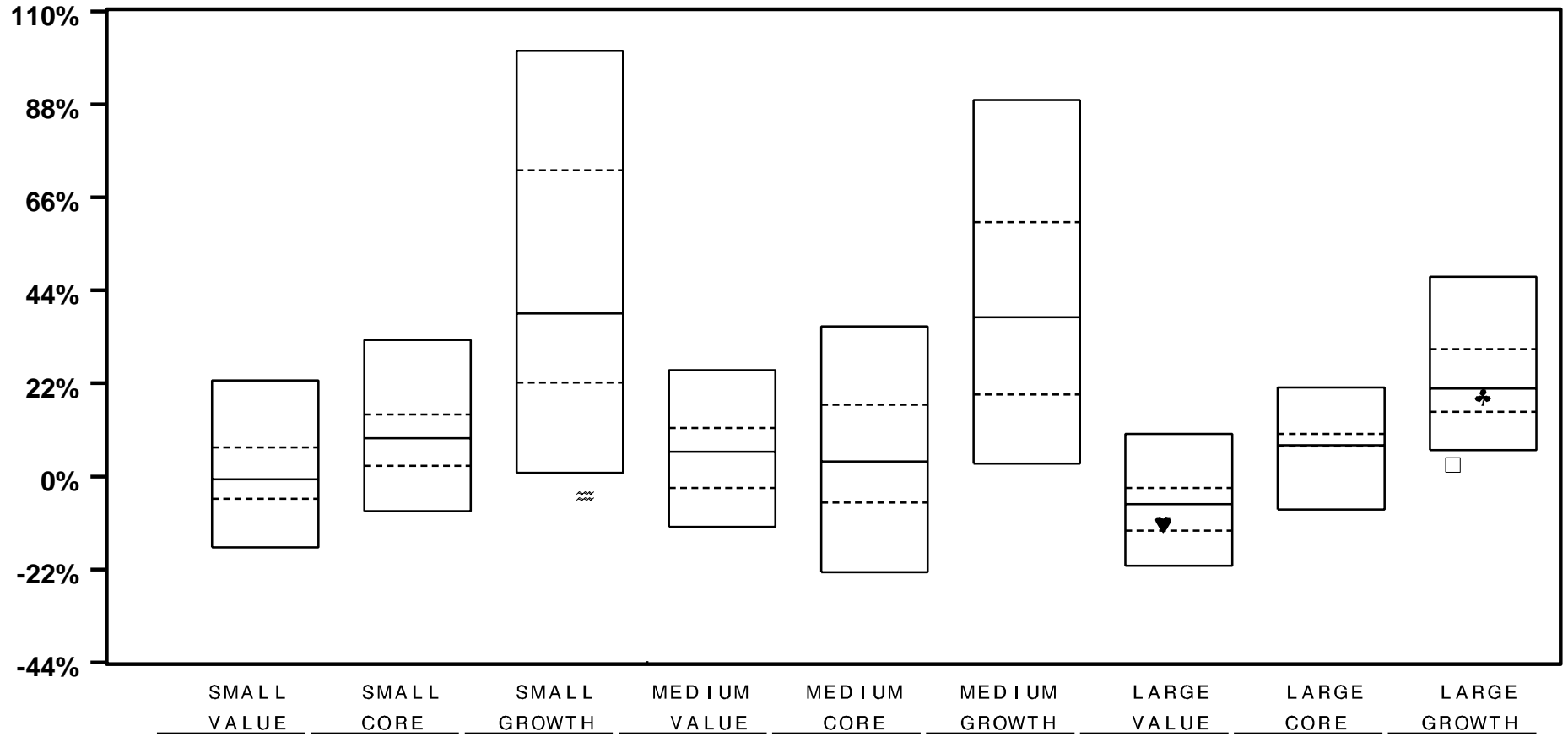

	SMALL VALUE	SMALL CORE	SMALL GROWTH	MEDIUM VALUE	MEDIUM CORE	MEDIUM GROWTH	LARGE VALUE	LARGE CORE	LARGE GROWTH
EQTY COMPOSITE									2.7 98
DELAWARE							- 11.3 72		
ALLIANCE									18.9 57
LAZARD			- 4.5 97						
MEDIAN	- 0.6	9.0	38.6	5.8	3.5	37.6	- 6.6	7.4	20.8

VERMONT MUNICIPAL EMPLOYEES

EQUITY MANAGER SPECTRUM STYLE ANALYSIS - EQUITY ONLY RETURNS

QUARTER ENDING 6/05

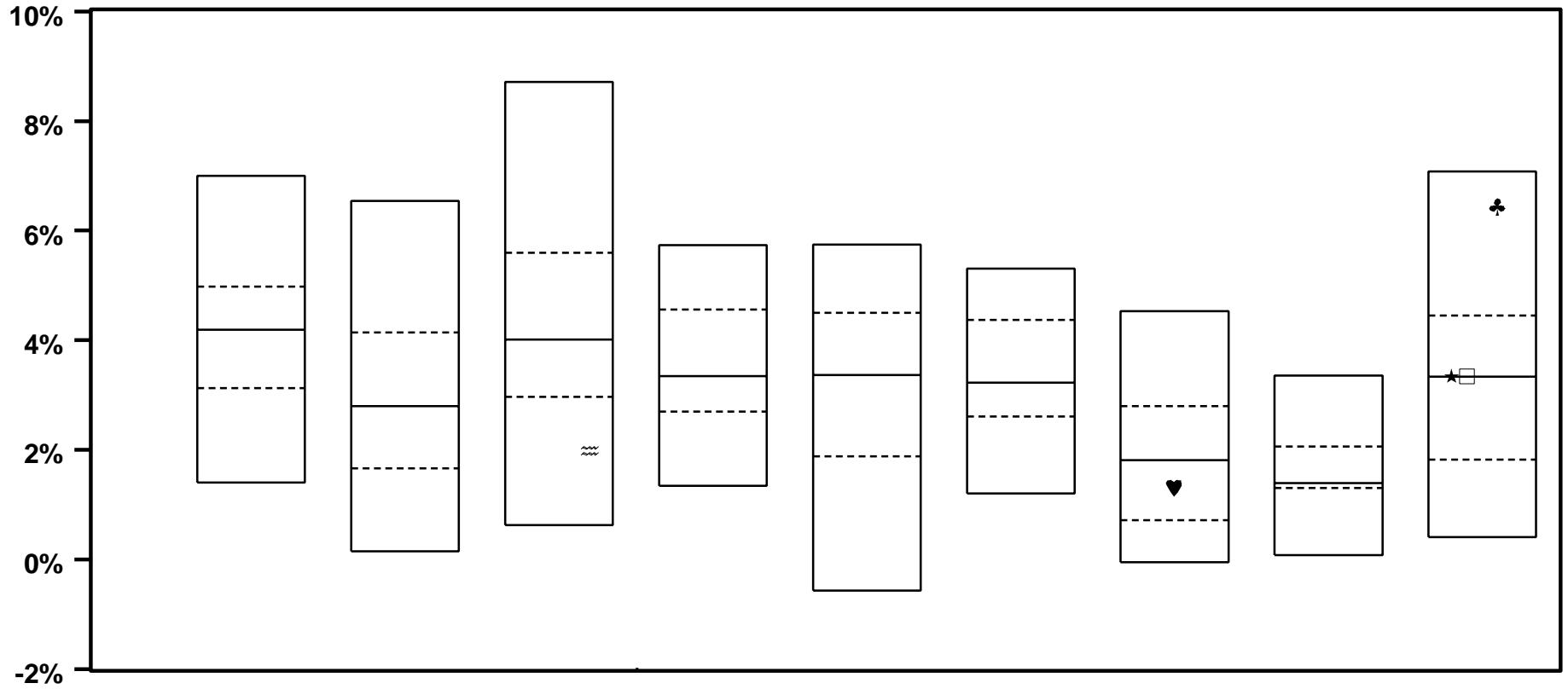

	SMALL VALUE	SMALL CORE	SMALL GROWTH	MEDIUM VALUE	MEDIUM CORE	MEDIUM GROWTH	LARGE VALUE	LARGE CORE	LARGE GROWTH
★ MUNI COMPOSITE									3.3 49
□ EQTY COMPOSITE									3.3 49
♥ DELAWARE							1.3 62		
♣ ALLIANCE									6.4 9
≈ LAZARD			2.0 87						
MEDIAN	4.2	2.8	4.0	3.4	3.4	3.2	1.8	1.4	3.3

VERMONT MUNICIPAL EMPLOYEES

EQUITY MANAGER SPECTRUM STYLE ANALYSIS - EQUITY ONLY RETURNS

YEAR ENDING 6/05

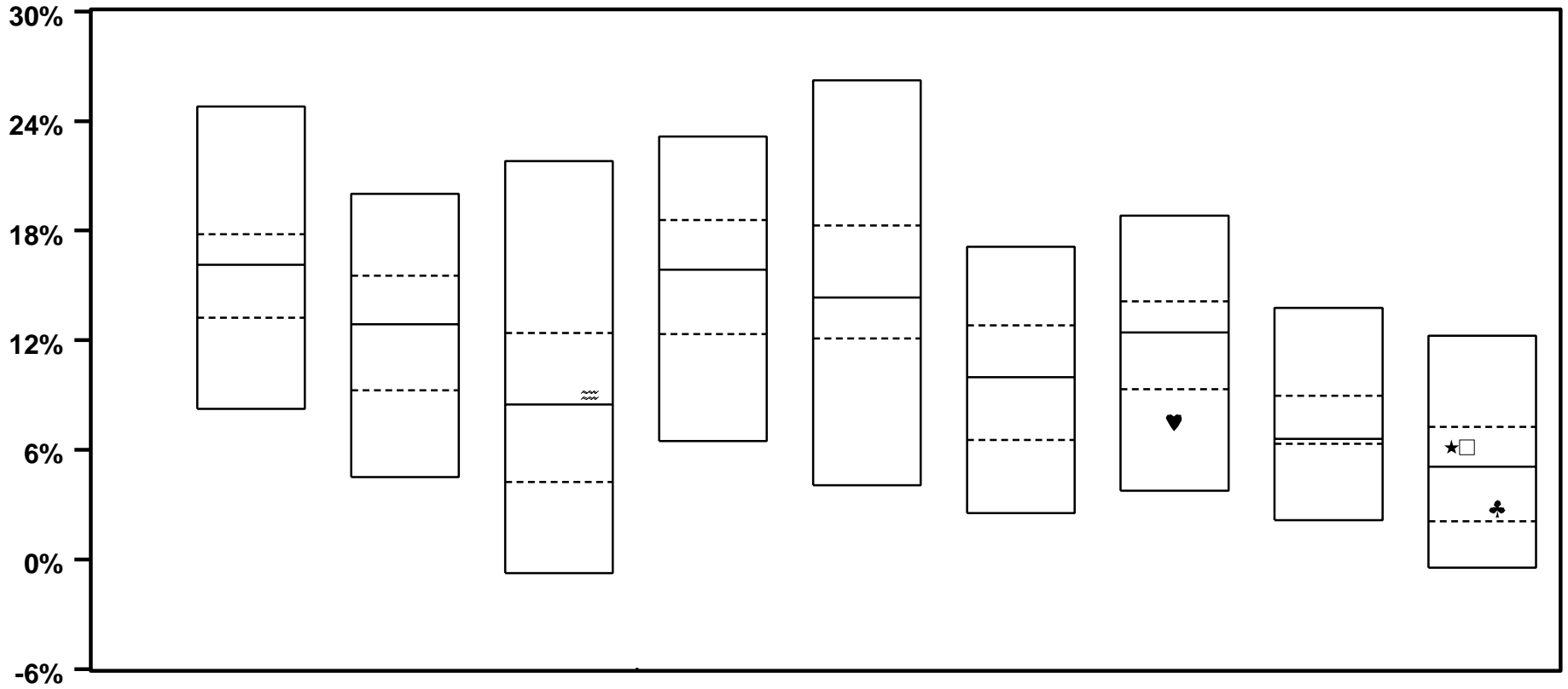

	SMALL VALUE	SMALL CORE	SMALL GROWTH	MEDIUM VALUE	MEDIUM CORE	MEDIUM GROWTH	LARGE VALUE	LARGE CORE	LARGE GROWTH
★ MUNI COMPOSITE									6.2 37
□ EQTY COMPOSITE									6.2 37
♥ DELAWARE							7.5 81		
♣ ALLIANCE									2.8 69
≈ LAZARD			9.0 48						
MEDIAN	16.1	12.9	8.5	15.9	14.3	10.0	12.4	6.6	5.1

VERMONT MUNICIPAL EMPLOYEES

EQUITY MANAGER SPECTRUM STYLE ANALYSIS - EQUITY ONLY RETURNS

TWO YEARS ENDING 6/05

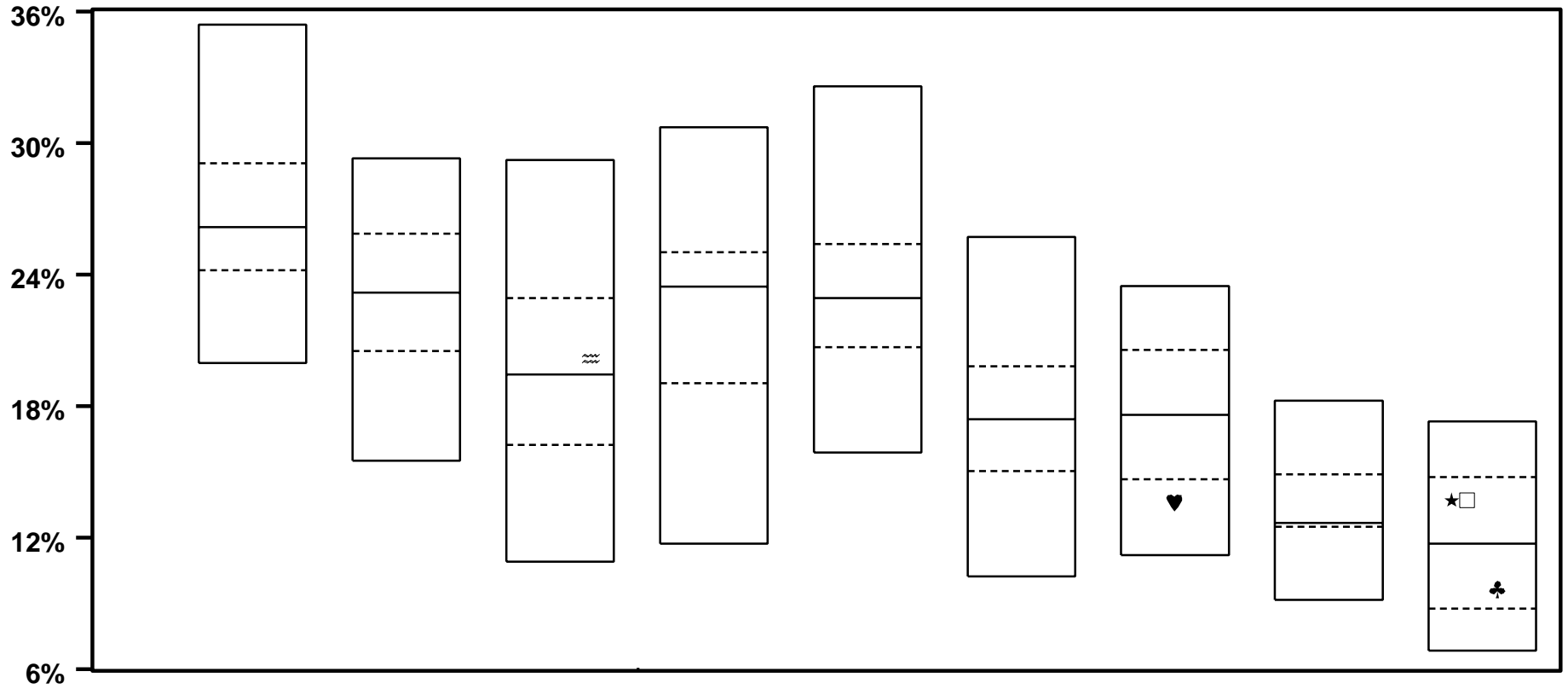

	SMALL VALUE	SMALL CORE	SMALL GROWTH	MEDIUM VALUE	MEDIUM CORE	MEDIUM GROWTH	LARGE VALUE	LARGE CORE	LARGE GROWTH
★ MUNI COMPOSITE									13.7 36
□ EQTY COMPOSITE									13.7 36
♥ DELAWARE							13.6 83		
♣ ALLIANCE									9.7 66
≈ LAZARD			20.2 41						
MEDIAN	26.2	23.2	19.4	23.4	22.9	17.4	17.6	12.7	11.7

VERMONT MUNICIPAL EMPLOYEES

EQUITY MANAGER SPECTRUM STYLE ANALYSIS - EQUITY ONLY RETURNS

THREE YEARS ENDING 6/05

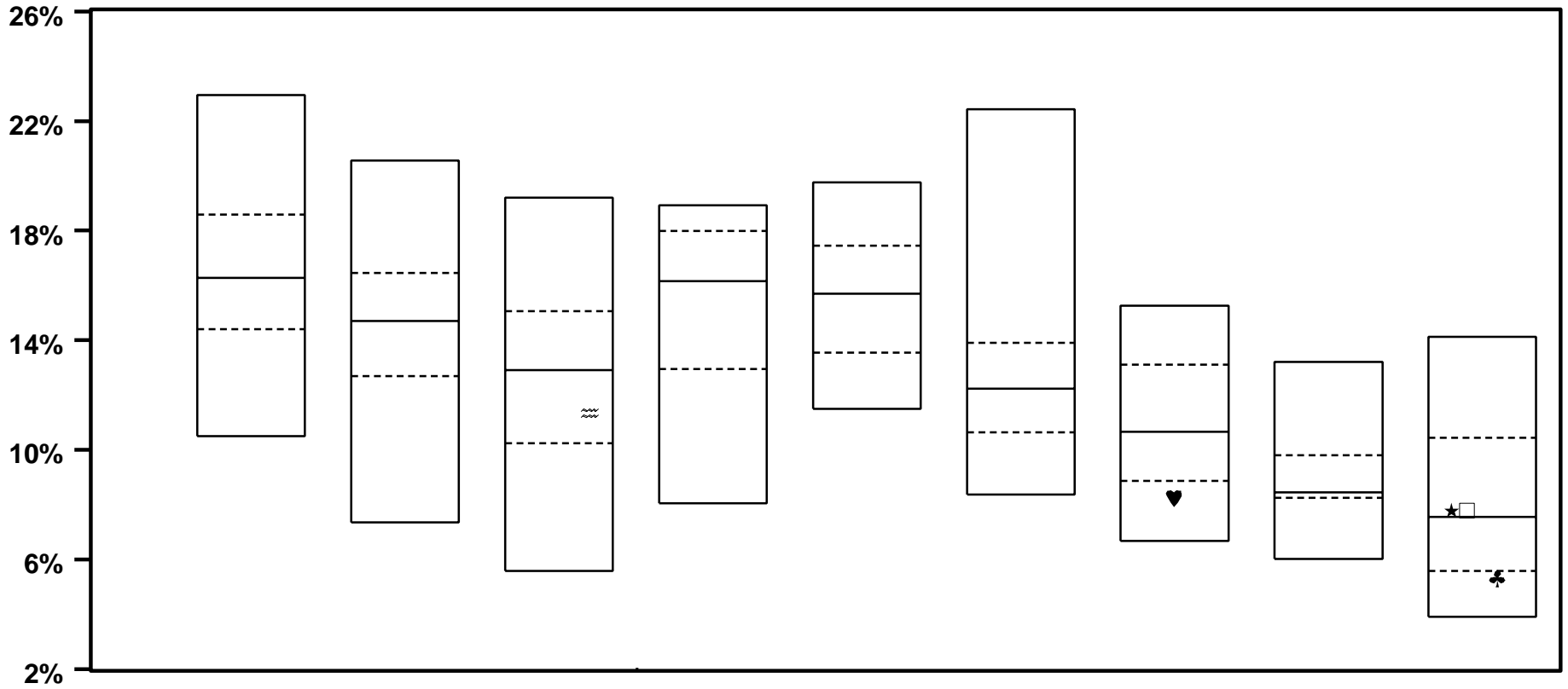

	SMALL VALUE	SMALL CORE	SMALL GROWTH	MEDIUM VALUE	MEDIUM CORE	MEDIUM GROWTH	LARGE VALUE	LARGE CORE	LARGE GROWTH
★ MUNI COMPOSITE									7.8 47
□ EQTY COMPOSITE									7.8 47
♥ DELAWARE							8.2 84		
♣ ALLIANCE									5.3 80
≈ LAZARD			11.4 65						
MEDIAN	16.3	14.7	12.9	16.1	15.7	12.2	10.7	8.4	7.6

VERMONT MUNICIPAL EMPLOYEES

EQUITY MANAGER SPECTRUM STYLE ANALYSIS - EQUITY ONLY RETURNS

FOUR YEARS ENDING 6/05

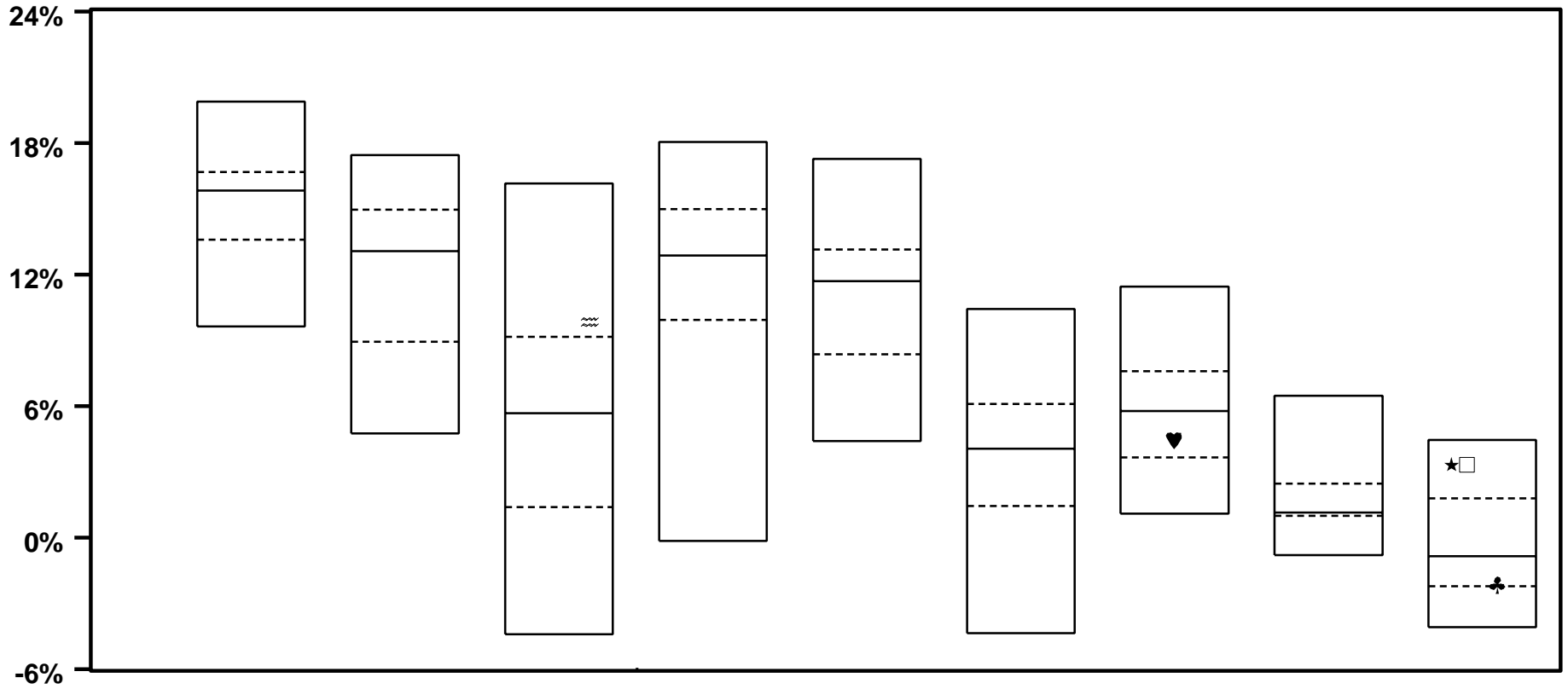

	SMALL VALUE	SMALL CORE	SMALL GROWTH	MEDIUM VALUE	MEDIUM CORE	MEDIUM GROWTH	LARGE VALUE	LARGE CORE	LARGE GROWTH
★ MUNI COMPOSITE									3.3 14
□ EQTY COMPOSITE									3.3 14
♥ DELAWARE							4.5 67		
♣ ALLIANCE									- 2.2 73
≡ LAZARD			9.8 20						
MEDIAN	15.8	13.1	5.7	12.9	11.7	4.0	5.8	1.1	- 0.8

VERMONT MUNICIPAL EMPLOYEES

EQUITY MANAGER SPECTRUM STYLE ANALYSIS - EQUITY ONLY RETURNS

FIVE YEARS ENDING 6/05

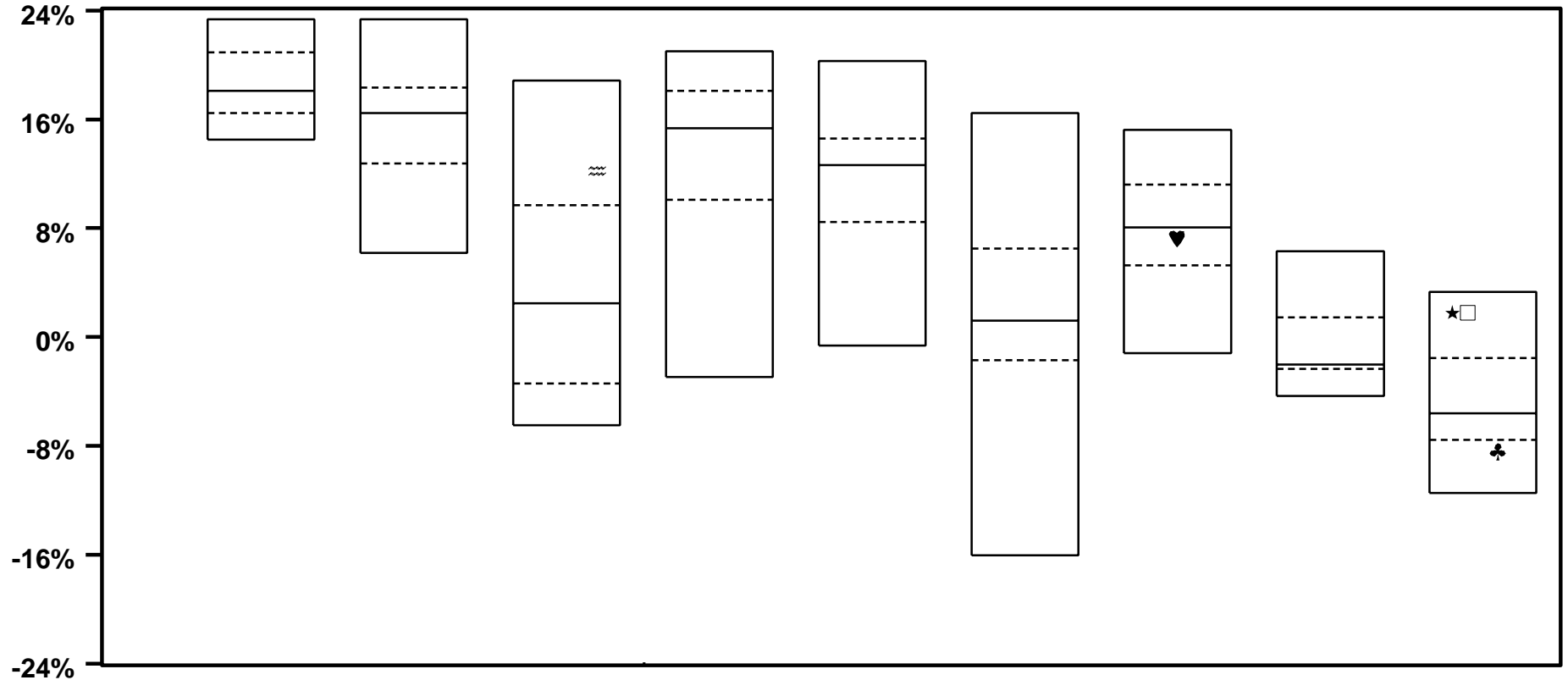

	SMALL VALUE	SMALL CORE	SMALL GROWTH	MEDIUM VALUE	MEDIUM CORE	MEDIUM GROWTH	LARGE VALUE	LARGE CORE	LARGE GROWTH
★ MUNI COMPOSITE									1.8 9
□ EQTY COMPOSITE									1.8 9
♥ DELAWARE							7.3 56		
♣ ALLIANCE									- 8.4 83
≈ LAZARD			12.2 19						
MEDIAN	18.1	16.4	2.5	15.3	12.7	1.2	8.1	- 2.0	- 5.6

VERMONT MUNICIPAL EMPLOYEES

EQUITY MANAGER SPECTRUM STYLE ANALYSIS - EQUITY ONLY RETURNS

YEAR ENDING 6/04

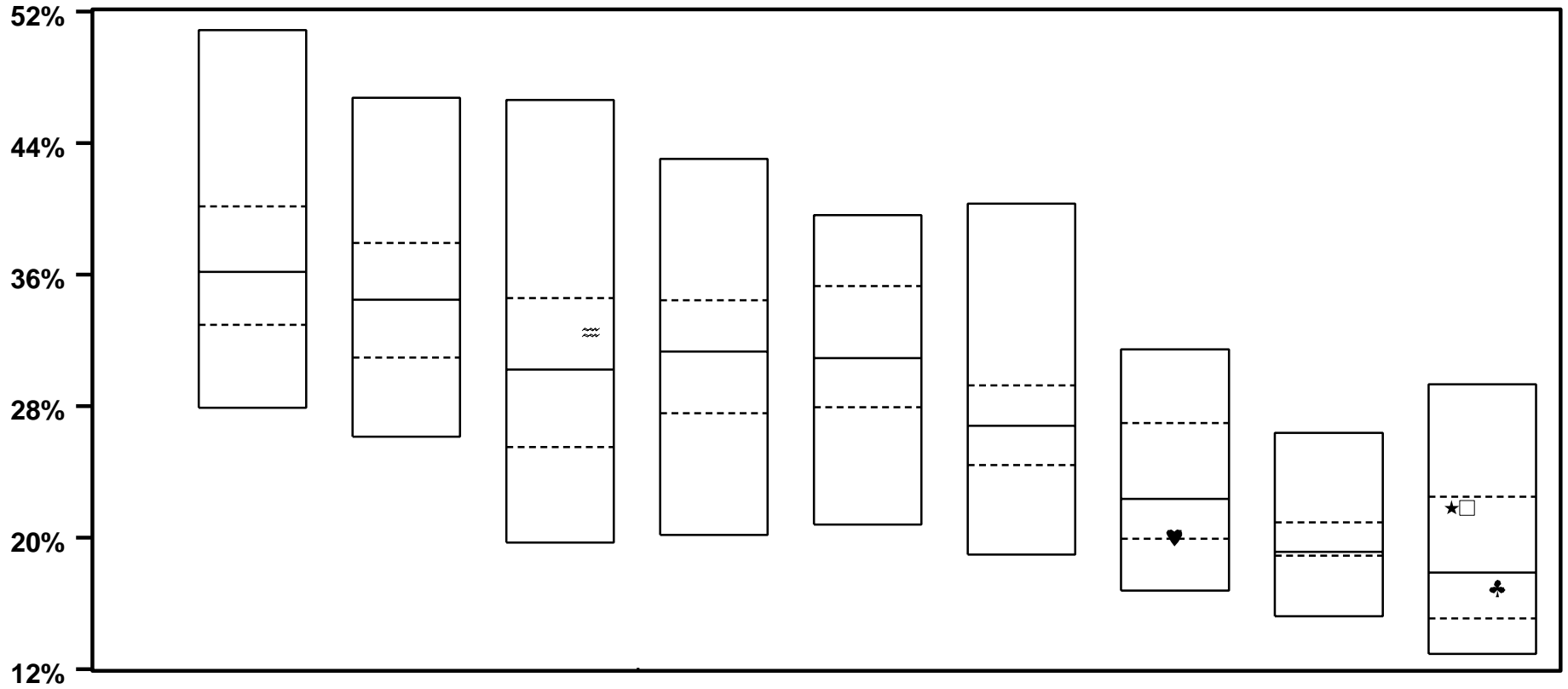

	SMALL VALUE	SMALL CORE	SMALL GROWTH	MEDIUM VALUE	MEDIUM CORE	MEDIUM GROWTH	LARGE VALUE	LARGE CORE	LARGE GROWTH
★ MUNI COMPOSITE									21.8 29
□ EQTY COMPOSITE									21.8 29
♥ DELAWARE							20.0 73		
♣ ALLIANCE									16.9 58
≈ LAZARD			32.5 36						
MEDIAN	36.1	34.5	30.2	31.3	30.9	26.8	22.3	19.1	17.9

VERMONT MUNICIPAL EMPLOYEES

EQUITY MANAGER SPECTRUM STYLE ANALYSIS - EQUITY ONLY RETURNS

YEAR ENDING 6/03

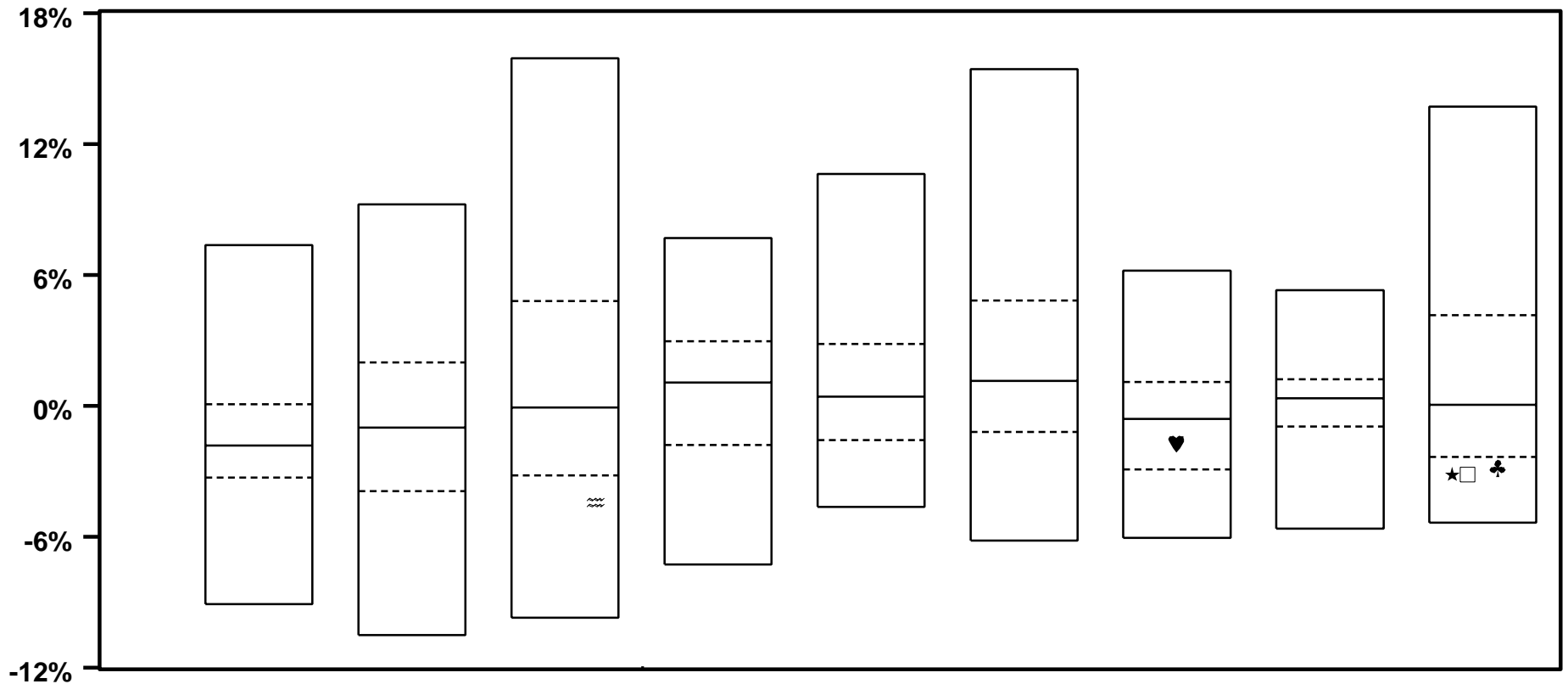

	SMALL VALUE	SMALL CORE	SMALL GROWTH	MEDIUM VALUE	MEDIUM CORE	MEDIUM GROWTH	LARGE VALUE	LARGE CORE	LARGE GROWTH
★ MUNI COMPOSITE									- 3.2 85
□ EQTY COMPOSITE									- 3.2 85
♥ DELAWARE							- 1.7 65		
♣ ALLIANCE									- 2.8 81
≈ LAZARD			- 4.4 79						
MEDIAN	- 1.8	- 1.0	- 0.1	1.1	0.4	1.2	- 0.6	0.3	0.1

VERMONT MUNICIPAL EMPLOYEES

EQUITY MANAGER SPECTRUM STYLE ANALYSIS - EQUITY ONLY RETURNS

YEAR ENDING 6/02

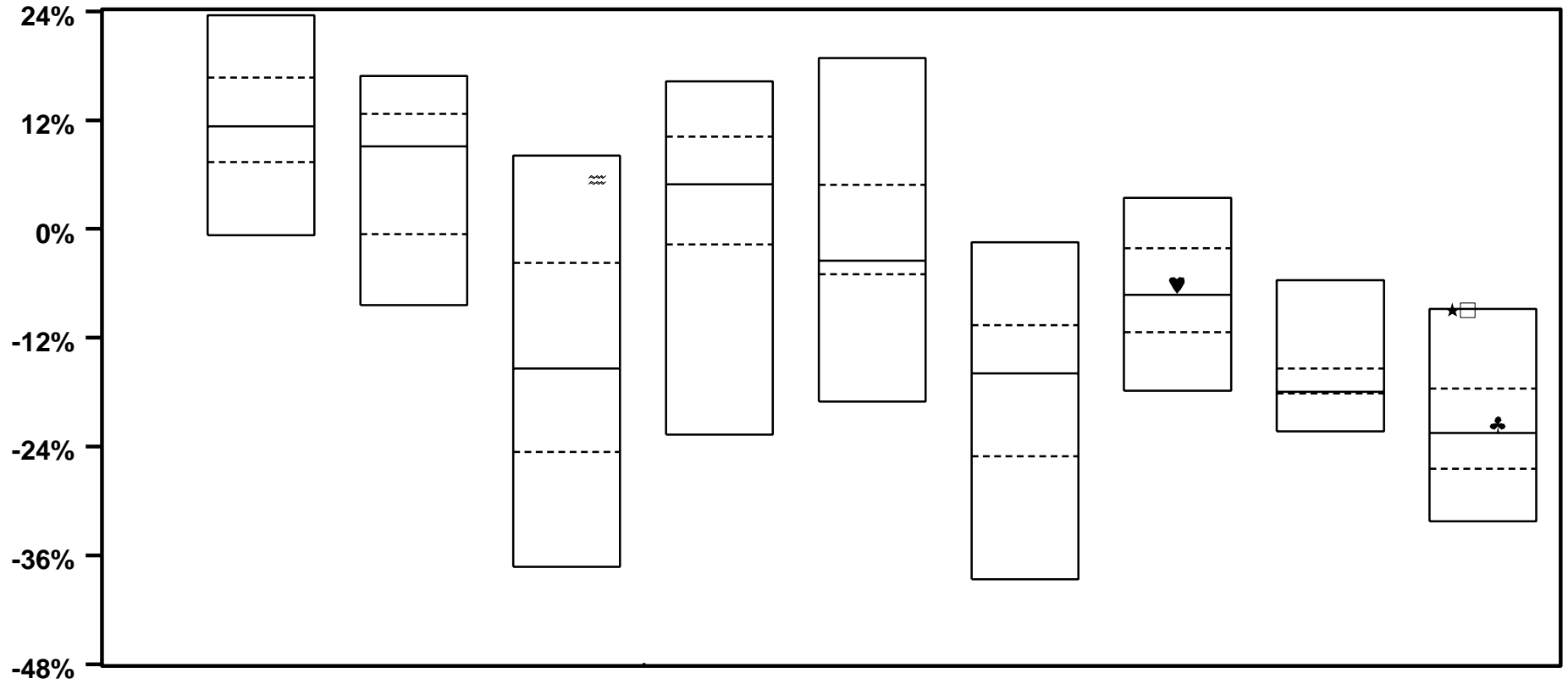

	SMALL VALUE	SMALL CORE	SMALL GROWTH	MEDIUM VALUE	MEDIUM CORE	MEDIUM GROWTH	LARGE VALUE	LARGE CORE	LARGE GROWTH
★ MUNI COMPOSITE									- 9.0 5
□ EQTY COMPOSITE									- 9.0 5
♥ DELAWARE							- 6.1 42		
♣ ALLIANCE									- 21.5 42
≈ LAZARD			5.4 9						
MEDIAN	11.3	9.1	- 15.4	4.9	- 3.5	- 15.9	- 7.3	- 17.9	- 22.5

VERMONT MUNICIPAL EMPLOYEES

EQUITY MANAGER SPECTRUM STYLE ANALYSIS - EQUITY ONLY RETURNS

YEAR ENDING 6/01

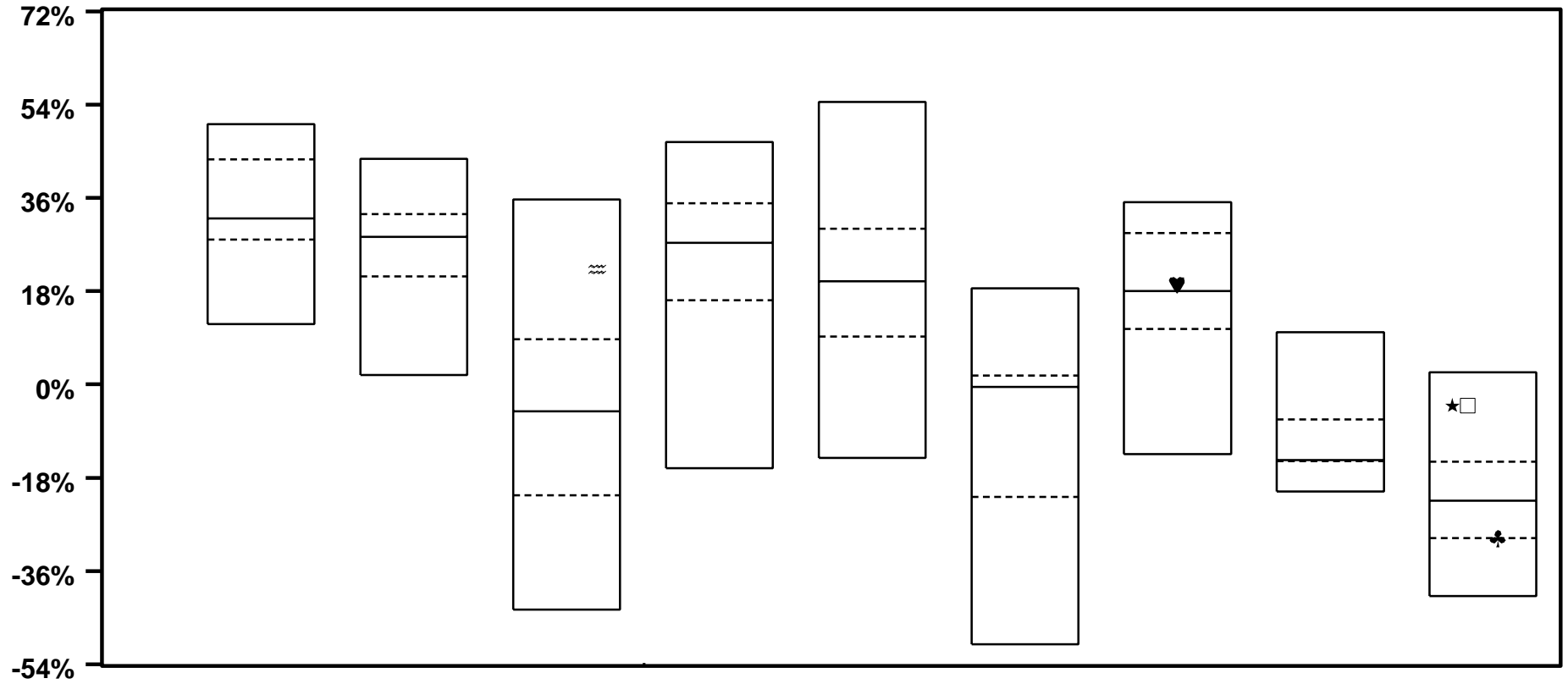

	SMALL VALUE	SMALL CORE	SMALL GROWTH	MEDIUM VALUE	MEDIUM CORE	MEDIUM GROWTH	LARGE VALUE	LARGE CORE	LARGE GROWTH
★ MUNI COMPOSITE									- 4.1 8
□ EQTY COMPOSITE									- 4.1 8
♥ DELAWARE							19.3 48		
♣ ALLIANCE									- 29.6 74
≈ LAZARD			22.2 15						
MEDIAN	32.0	28.4	- 5.2	27.3	19.9	- 0.5	18.0	- 14.6	- 22.4

VERMONT MUNICIPAL EMPLOYEES

EQUITY MANAGER SPECTRUM STYLE ANALYSIS - EQUITY ONLY RETURNS

YEAR ENDING 6/00

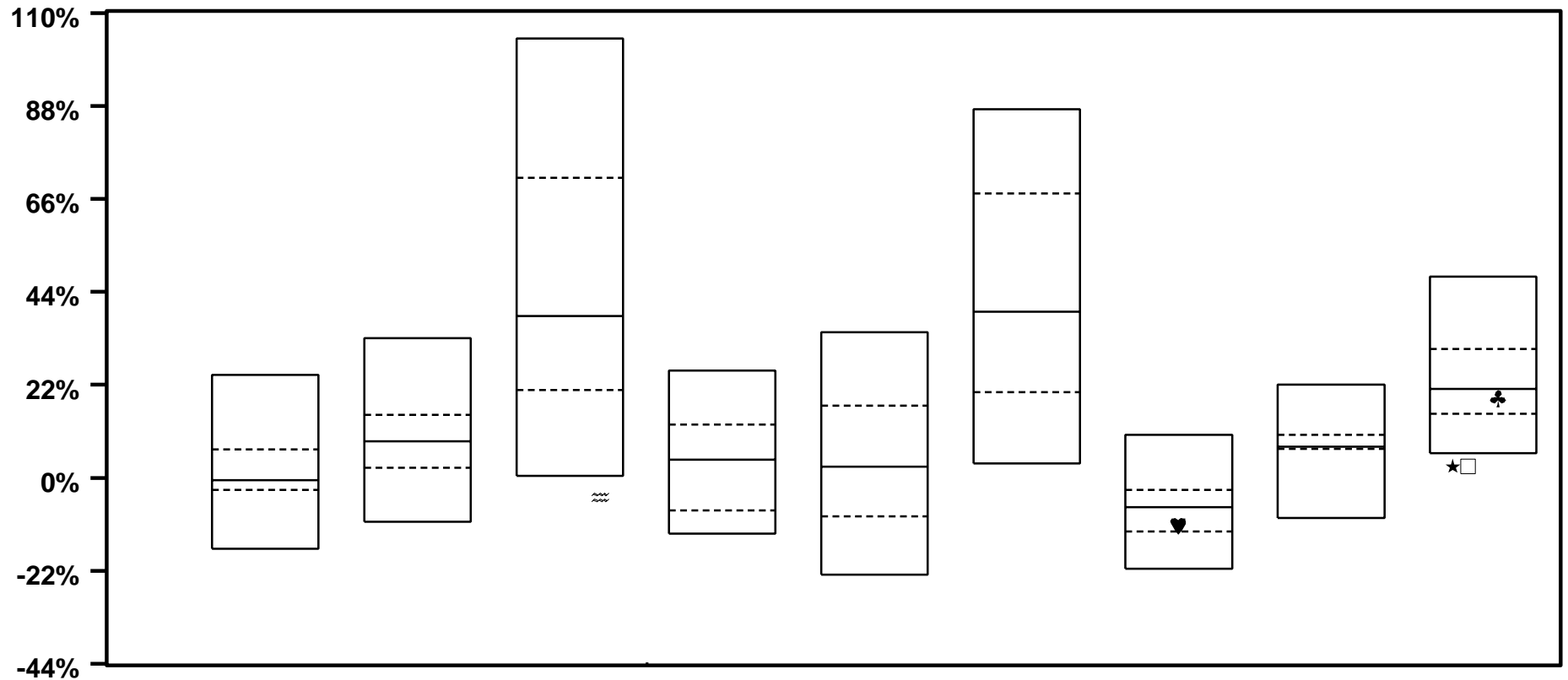

	SMALL VALUE	SMALL CORE	SMALL GROWTH	MEDIUM VALUE	MEDIUM CORE	MEDIUM GROWTH	LARGE VALUE	LARGE CORE	LARGE GROWTH
★ MUNI COMPOSITE									2.7 97
□ EQTY COMPOSITE									2.7 97
♥ DELAWARE							- 11.3 72		
♣ ALLIANCE									18.9 57
≈ LAZARD			- 4.5 97						
MEDIAN	- 0.5	8.6	38.3	4.3	2.7	39.3	- 7.0	7.3	21.0

VERMONT MUNICIPAL EMPLOYEES
EQUITY STYLE SPECTRUM ANALYSIS
AS OF 6/05
(MOVEMENT OVER PAST TWO YEARS)

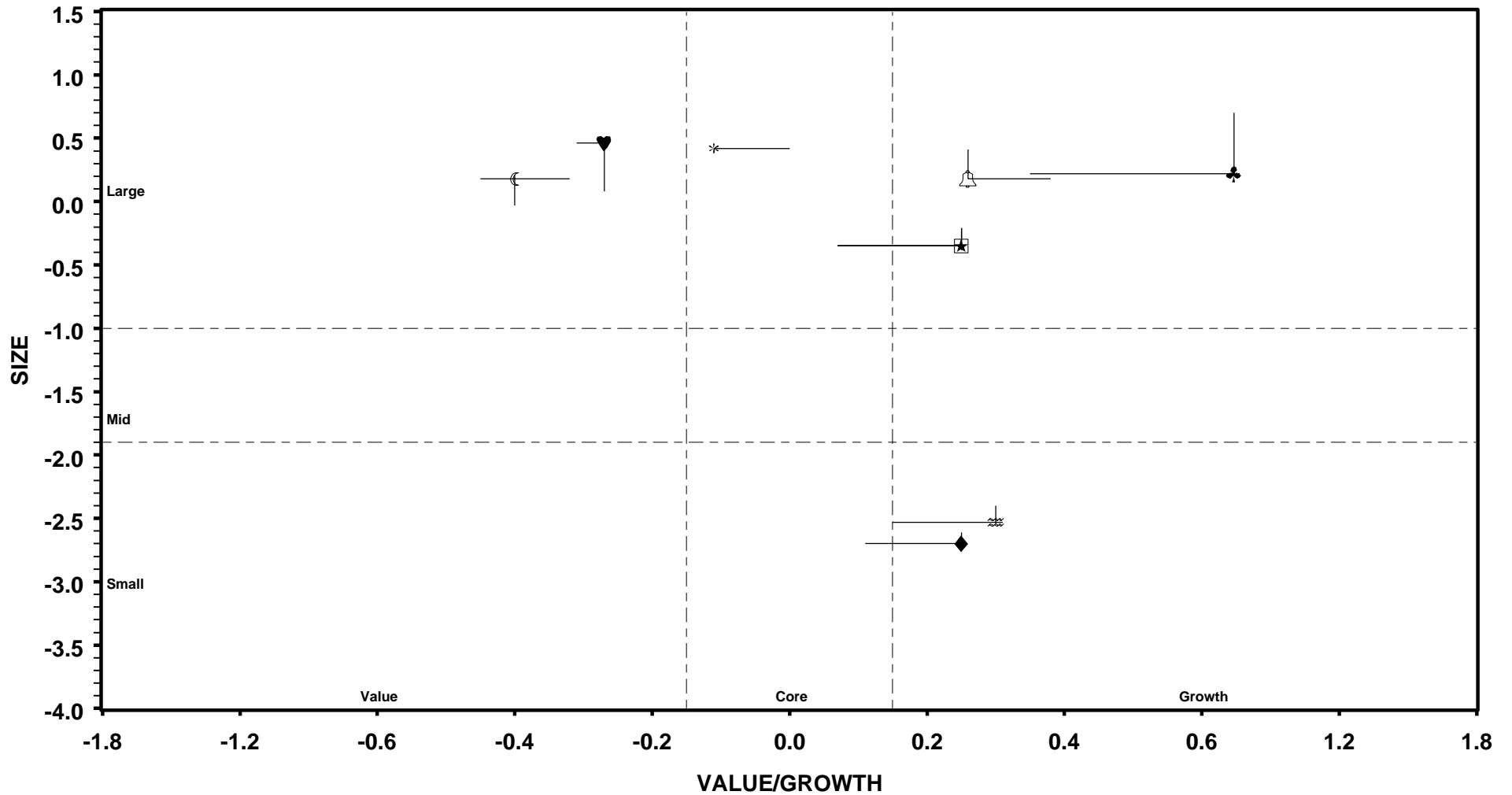

★ MUNI COMPOSITE	□ EQTY COMPOSITE	♥ DELAWARE	♣ ALLIANCE	≡ LAZARD
* S&P 500	⌘ R 1000(R) GR	⌘ R 1000(R) VALUE	⬢ R 2000(R)	

VERMONT MUNICIPAL EMPLOYEES

EQUITY STYLE SPECTRUM ANALYSIS

CURRENT DISTRIBUTION AND PORTFOLIO HISTORY

AS OF 6/05

MUNICIPAL SYSTEM COMPOSITE

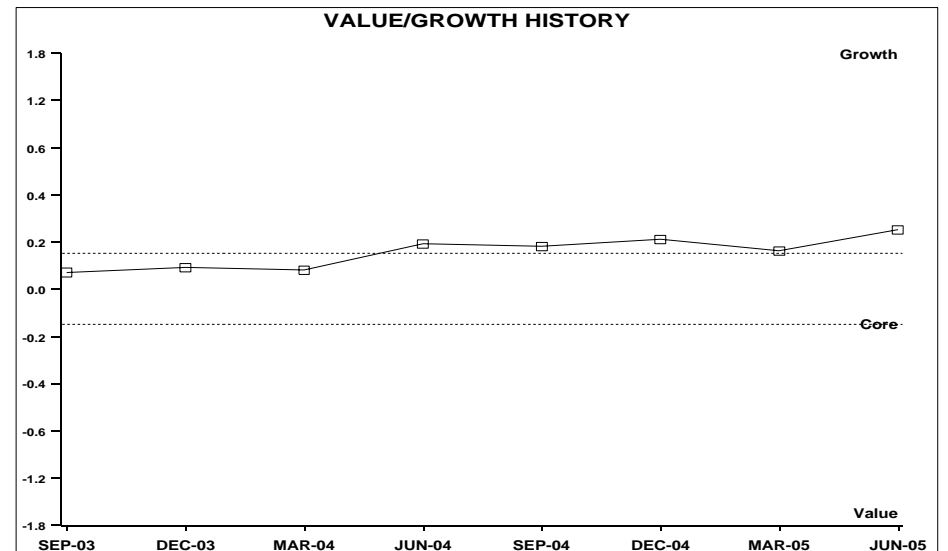
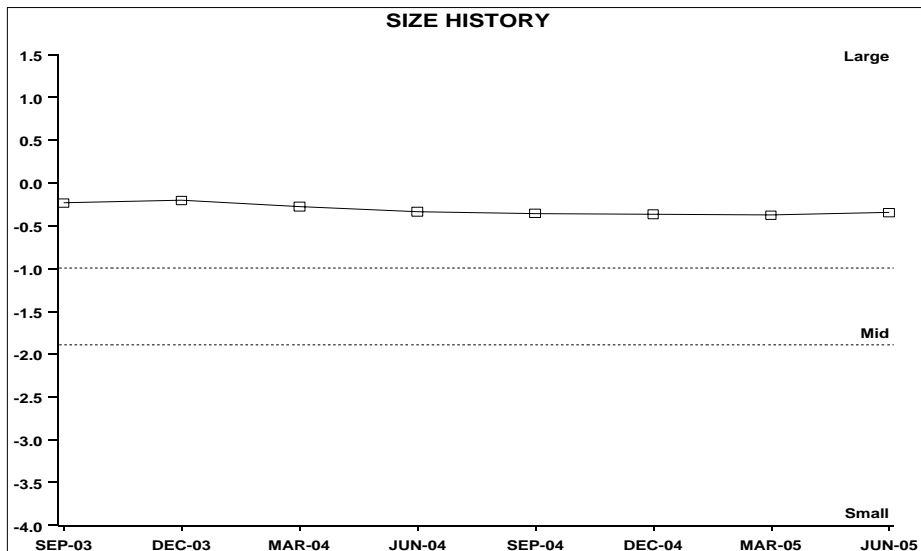
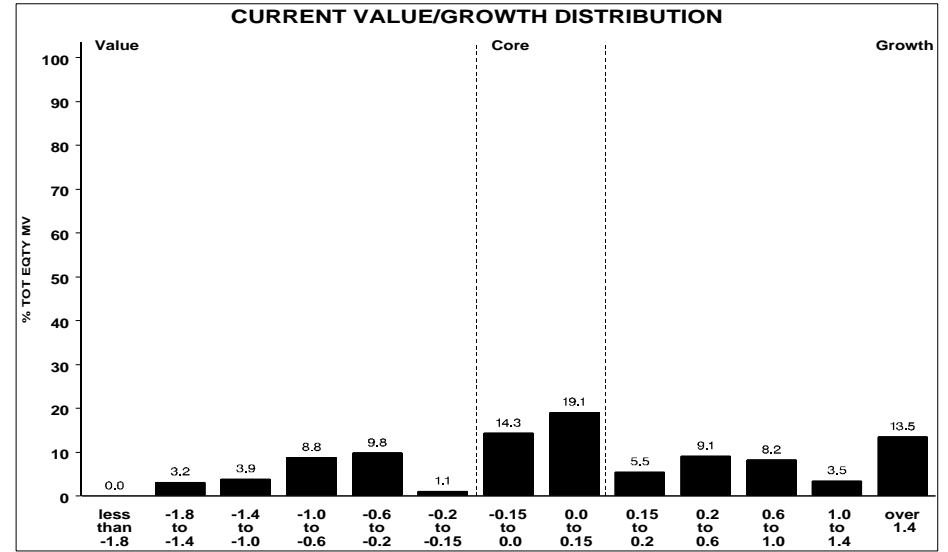
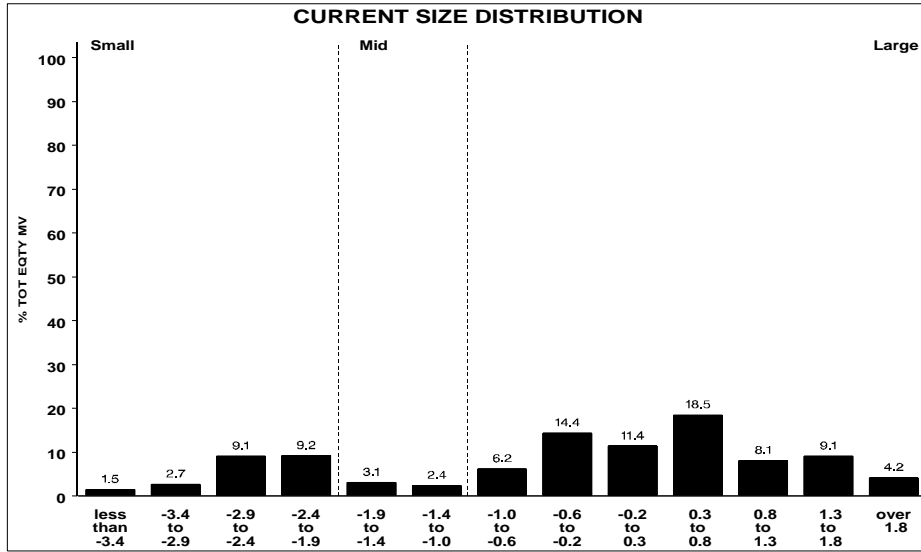

VERMONT MUNICIPAL EMPLOYEES

EQUITY STYLE SPECTRUM ANALYSIS

CURRENT DISTRIBUTION AND PORTFOLIO HISTORY

AS OF 6/05

DOMESTIC EQUITY COMPOSITE

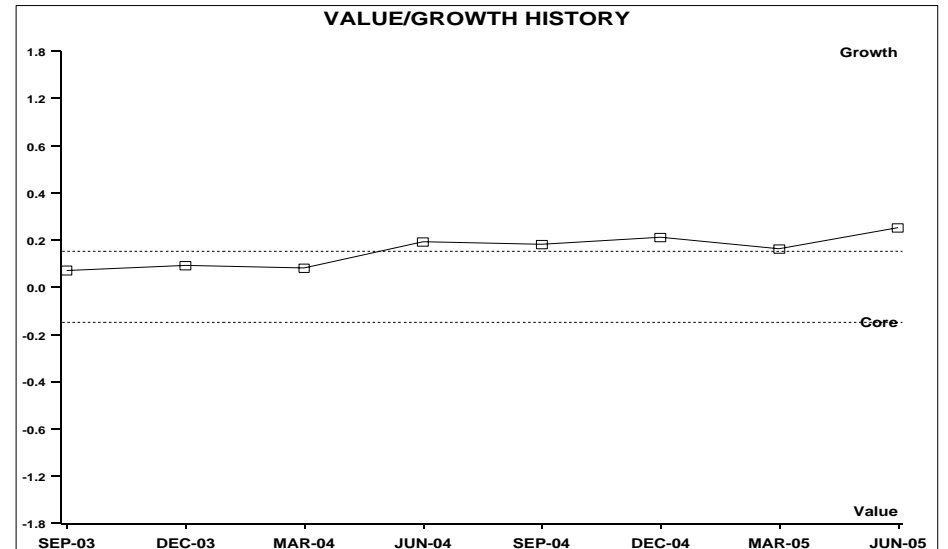
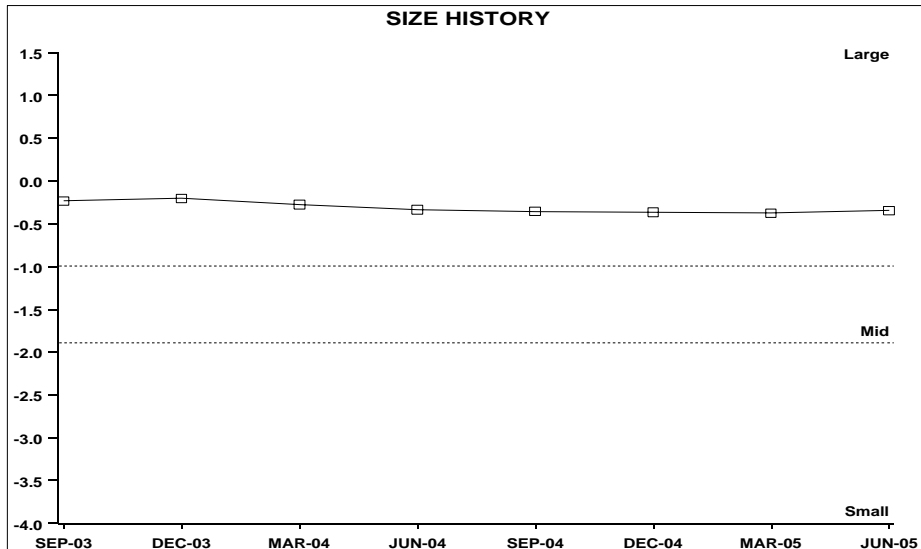
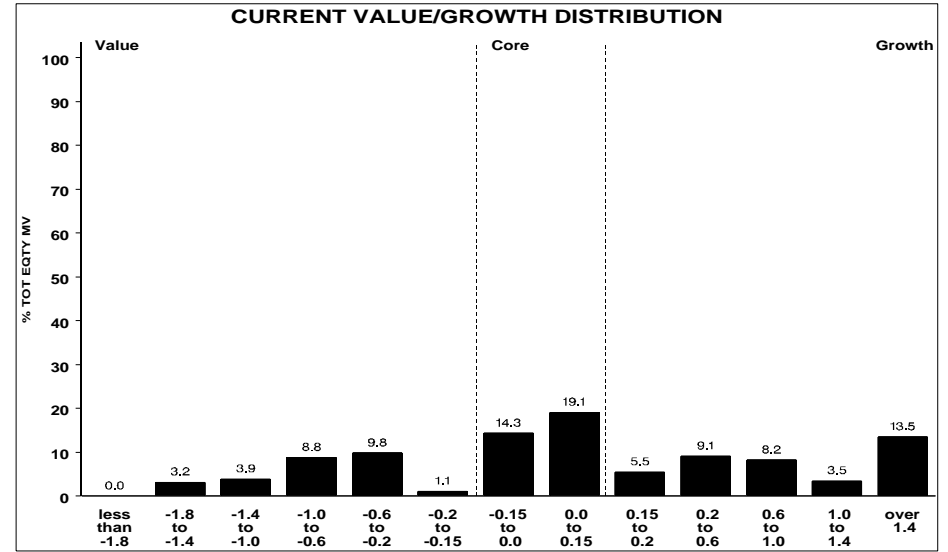
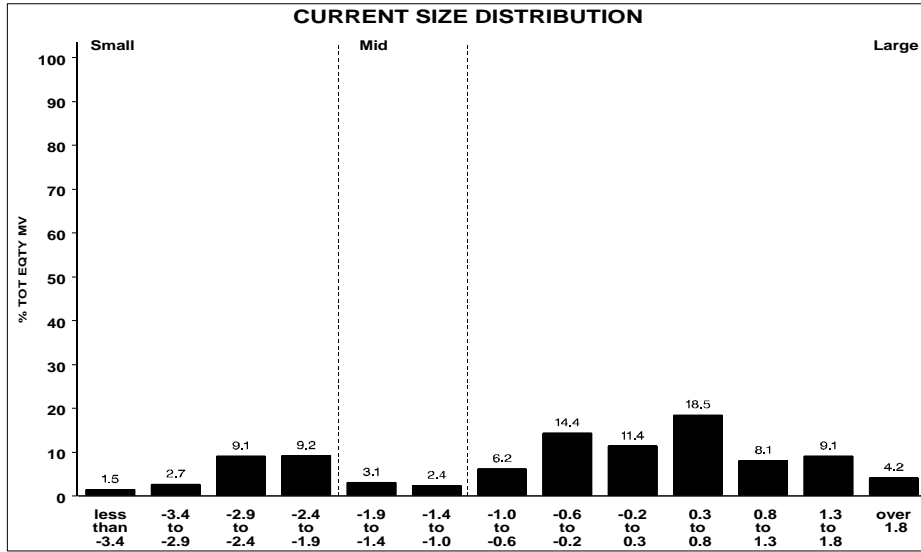

VERMONT MUNICIPAL EMPLOYEES

EQUITY STYLE SPECTRUM ANALYSIS

CURRENT DISTRIBUTION AND PORTFOLIO HISTORY

AS OF 6/05

DELAWARE

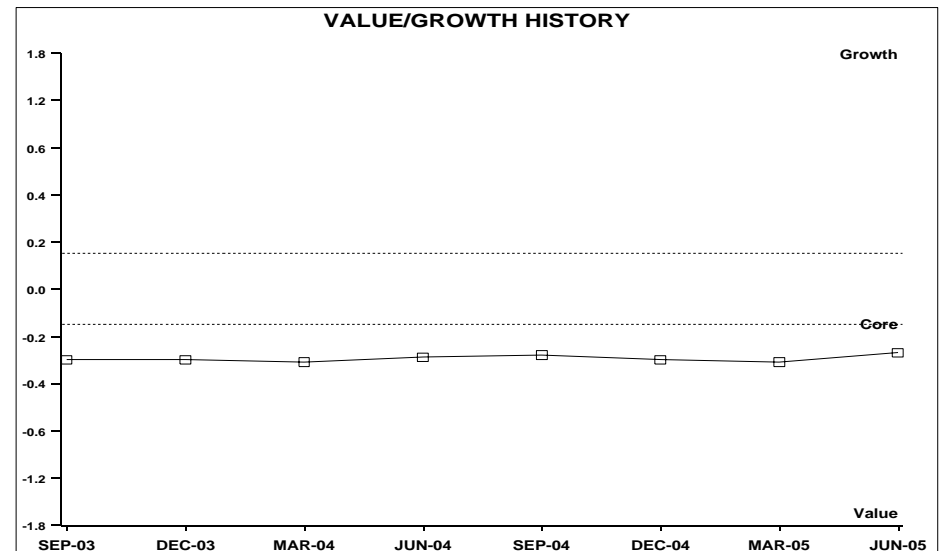
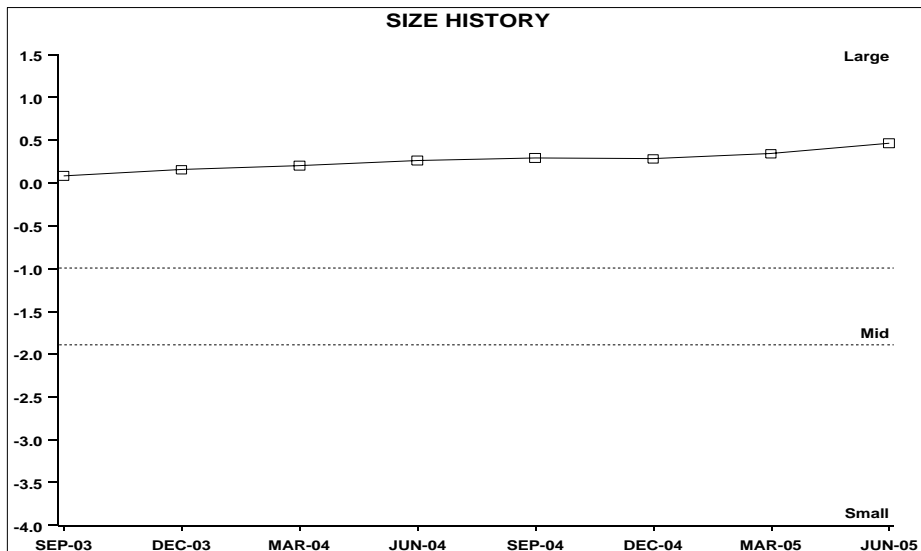
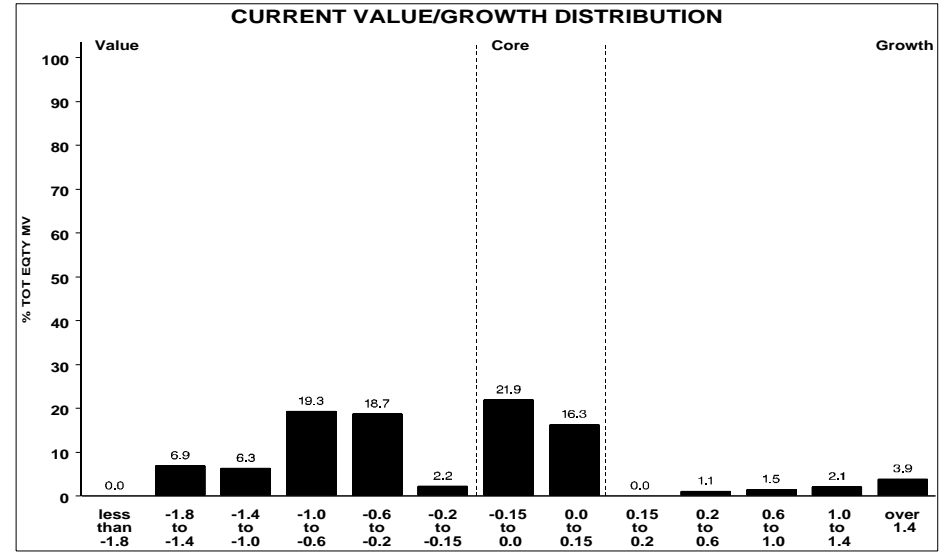
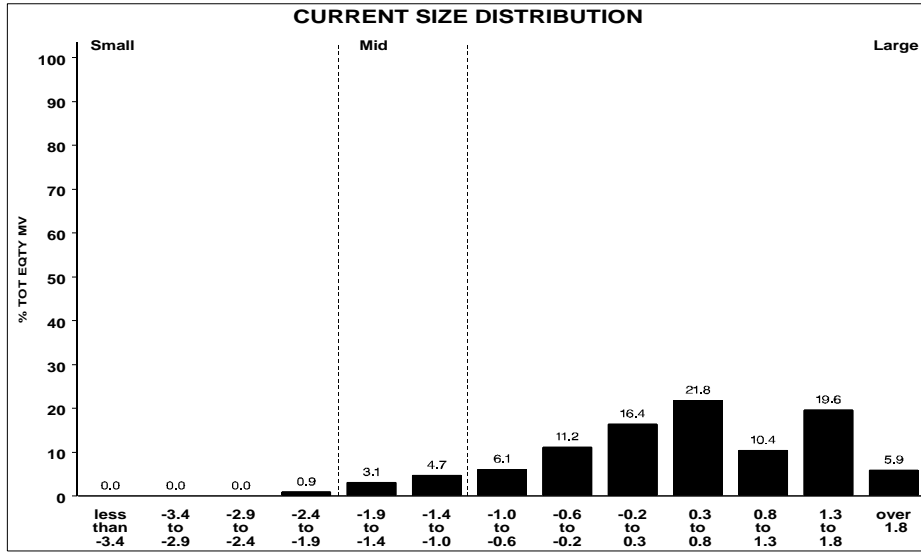

VERMONT MUNICIPAL EMPLOYEES

EQUITY STYLE SPECTRUM ANALYSIS

CURRENT DISTRIBUTION AND PORTFOLIO HISTORY

AS OF 6/05

ALLIANCE LARGE CAP GROWTH FUND

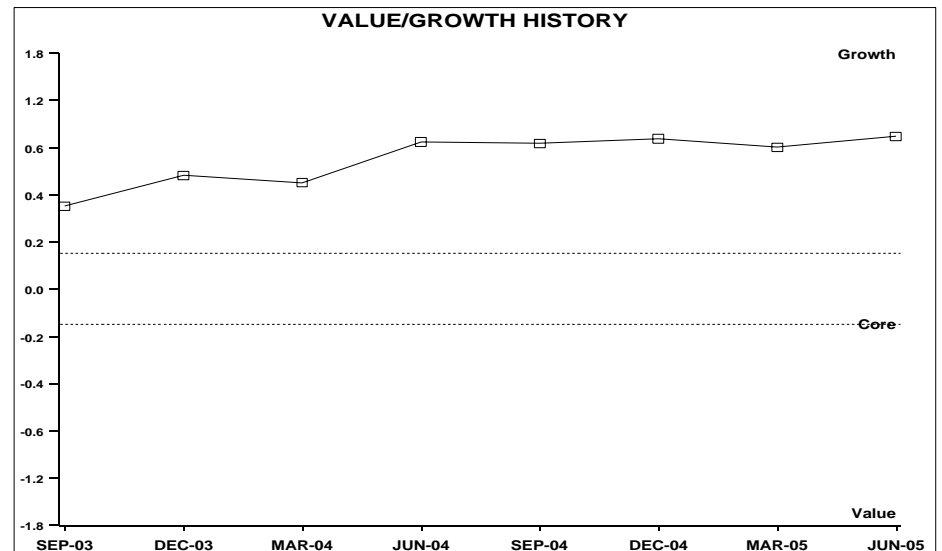
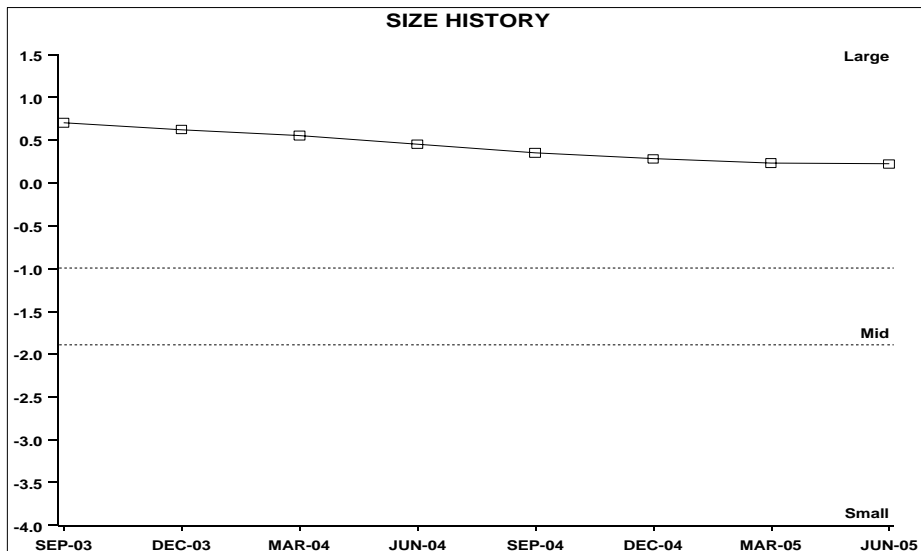
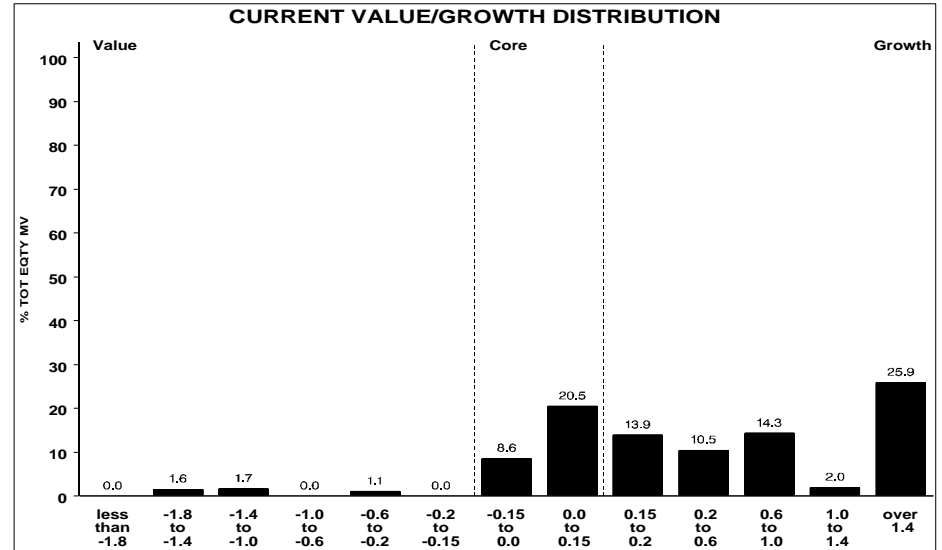
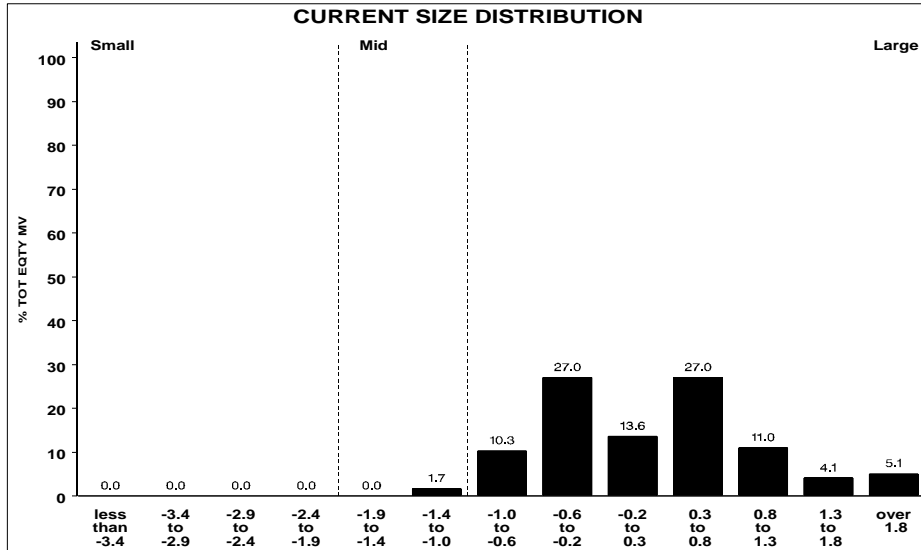

VERMONT MUNICIPAL EMPLOYEES

EQUITY STYLE SPECTRUM ANALYSIS

CURRENT DISTRIBUTION AND PORTFOLIO HISTORY

AS OF 6/05

LAZARD SMALL CAP FUND

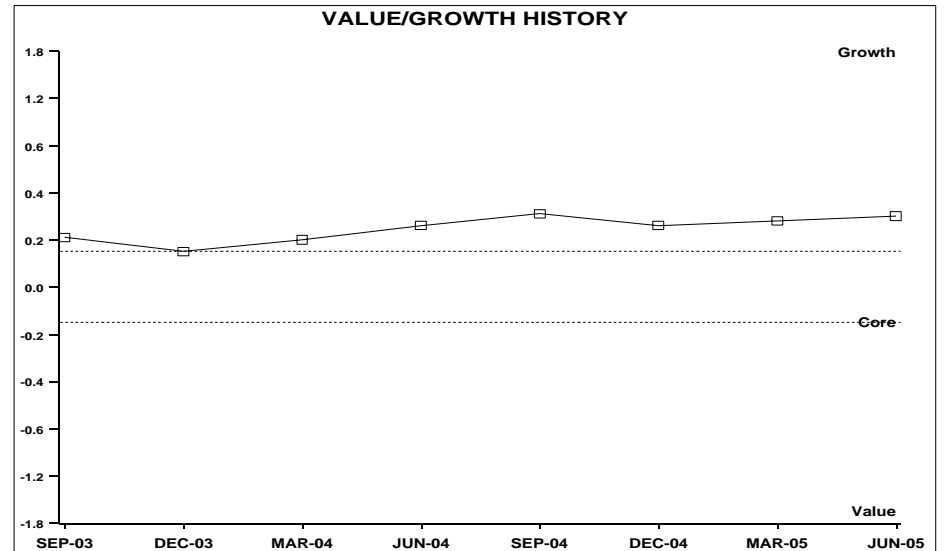
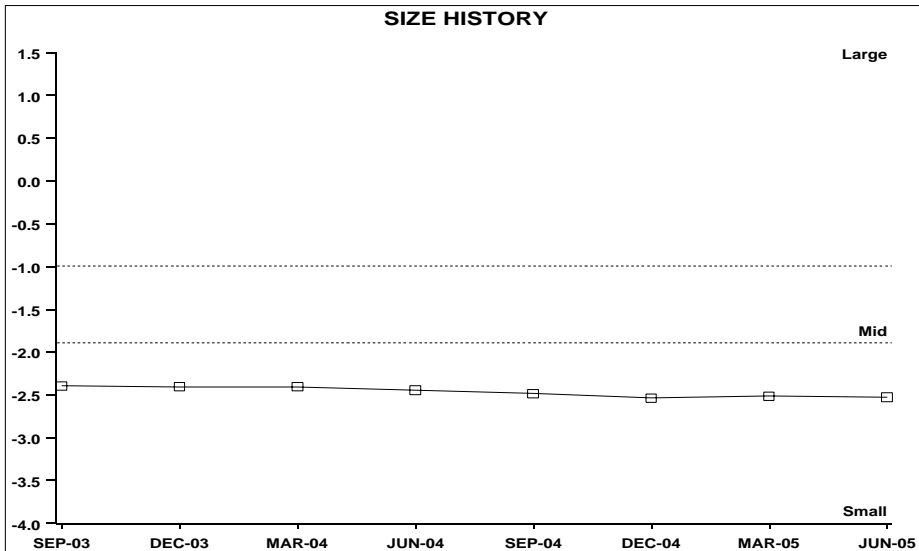
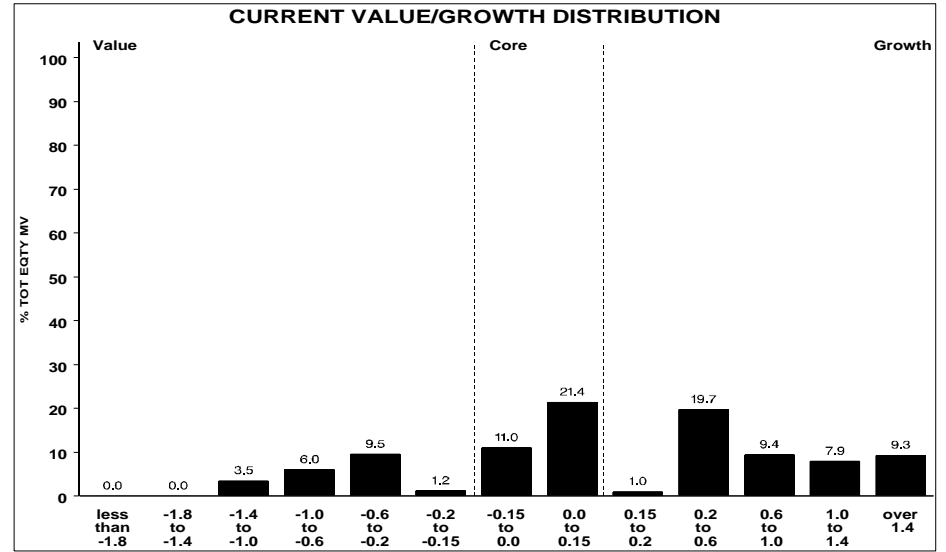
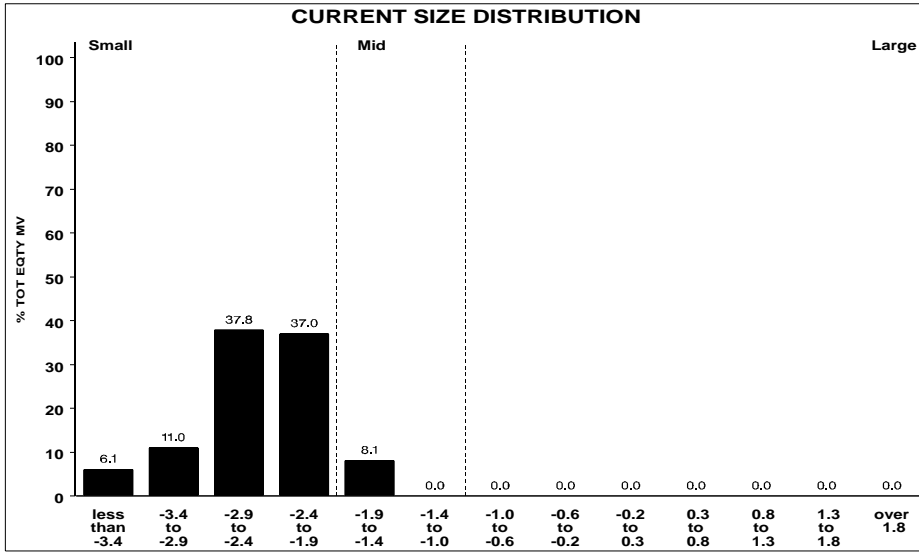

VERMONT MUNICIPAL EMPLOYEES

INT'L DEVELOPED MKT EQUITY MANAGER STYLE ANALYSIS - TOTAL RETURNS

QUARTER ENDING 6/05

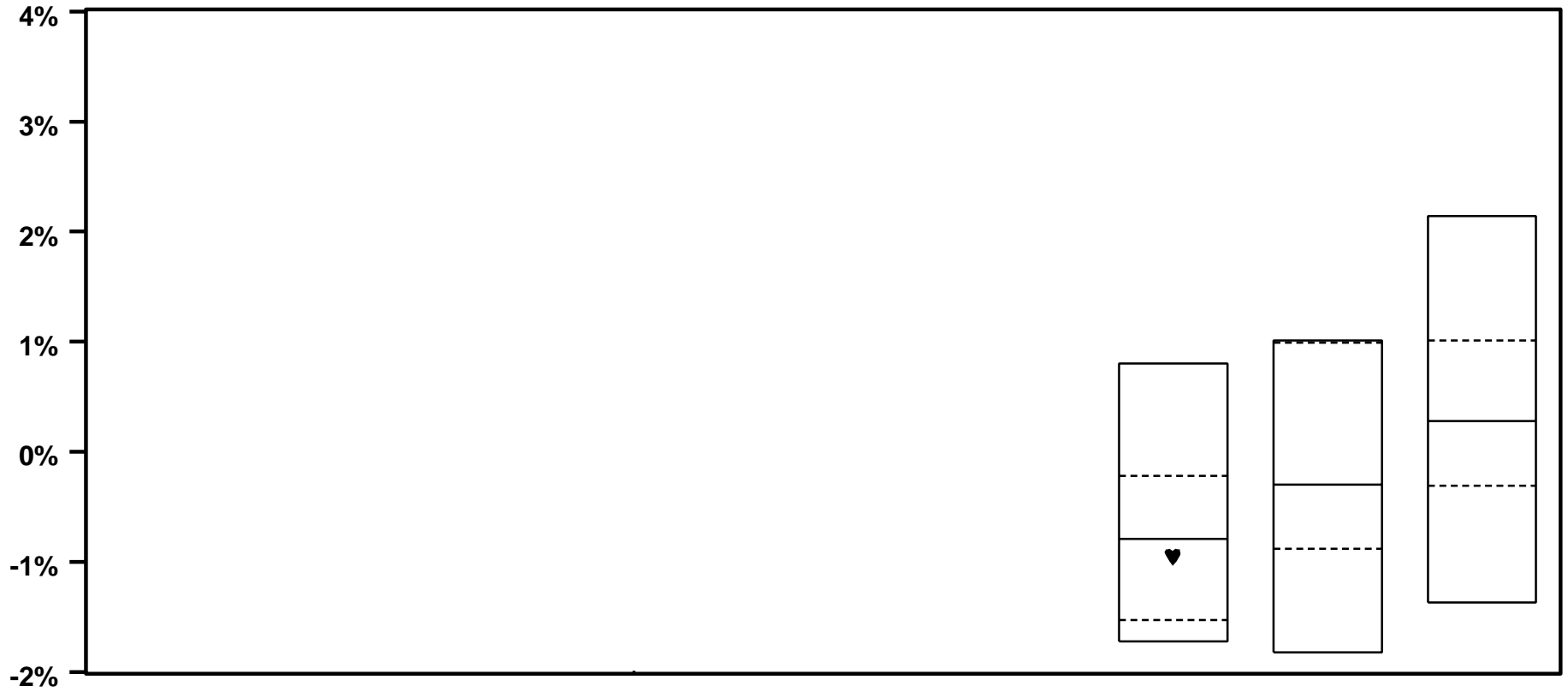

♥ UBS

MEDIAN

	LARGE VALUE	LARGE CORE	LARGE GROWTH
UBS	- 1.0	55	
MEDIAN	- 0.8	- 0.3	0.3

VERMONT MUNICIPAL EMPLOYEES

INT'L DEVELOPED MKT EQUITY MANAGER STYLE ANALYSIS - TOTAL RETURNS

YEAR ENDING 6/05

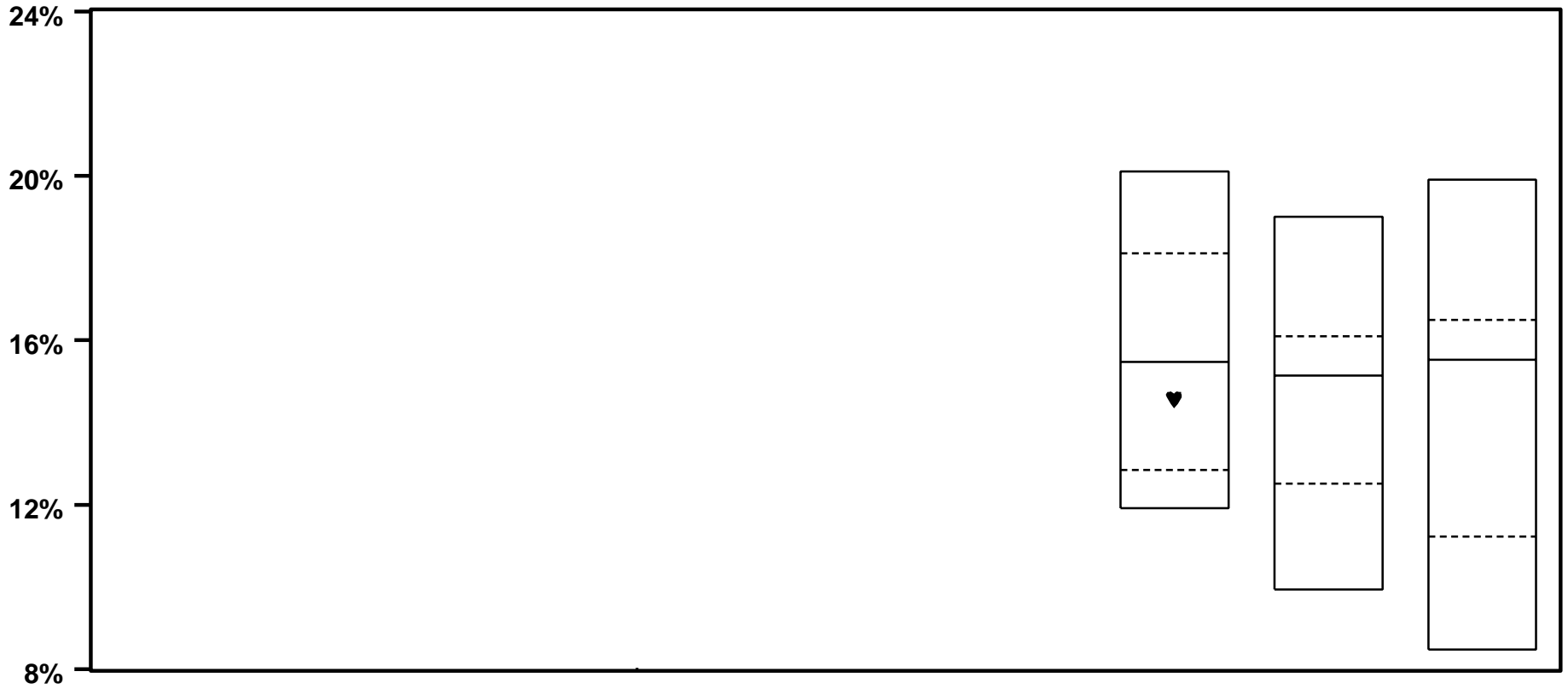

	LARGE VALUE	LARGE CORE	LARGE GROWTH
♥ UBS	14.6		
MEDIAN	15.5	15.1	15.5

VERMONT MUNICIPAL EMPLOYEES

INT'L DEVELOPED MKT EQUITY MANAGER STYLE ANALYSIS - TOTAL RETURNS

TWO YEARS ENDING 6/05

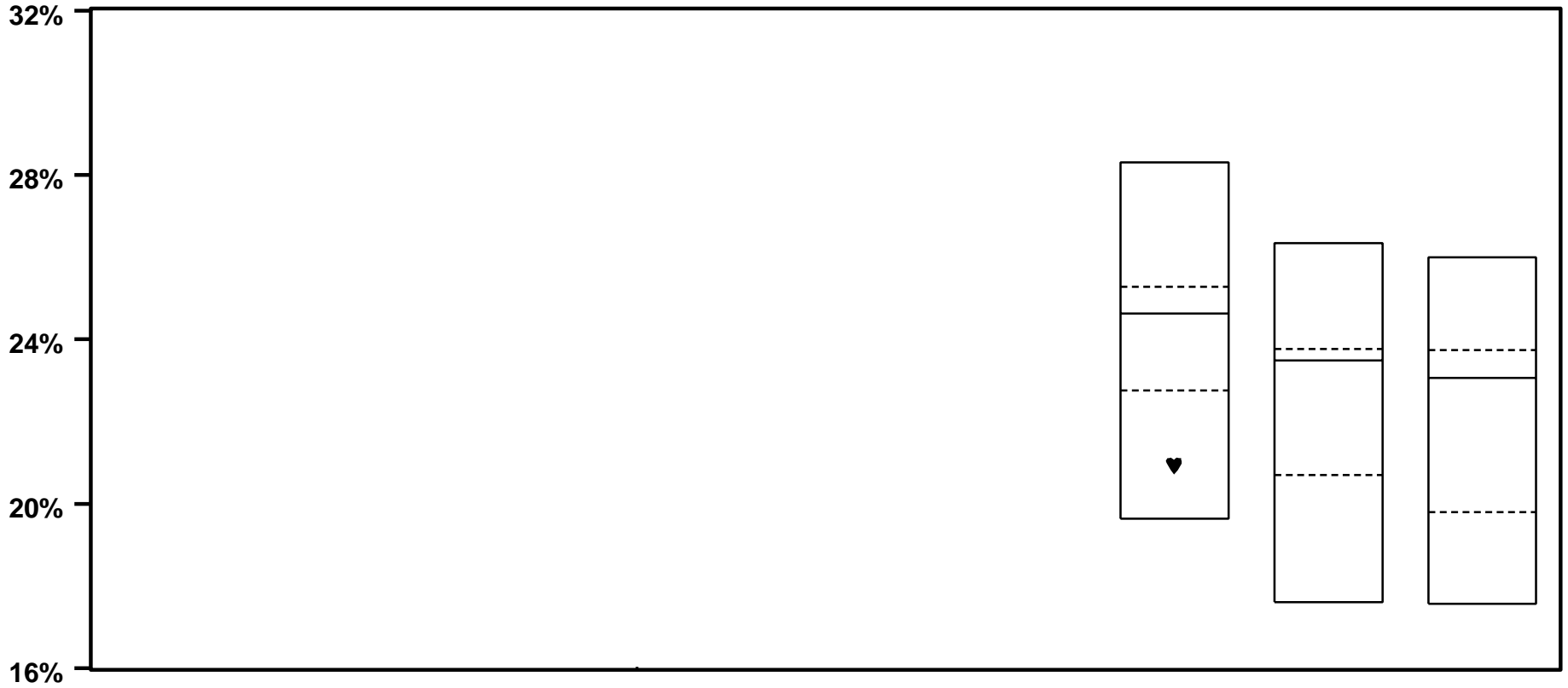

	LARGE VALUE	LARGE CORE	LARGE GROWTH
♥ UBS	20.9		
MEDIAN	24.6	23.5	23.1

VERMONT MUNICIPAL EMPLOYEES

INT'L DEVELOPED MKT EQUITY MANAGER STYLE ANALYSIS - TOTAL RETURNS

THREE YEARS ENDING 6/05

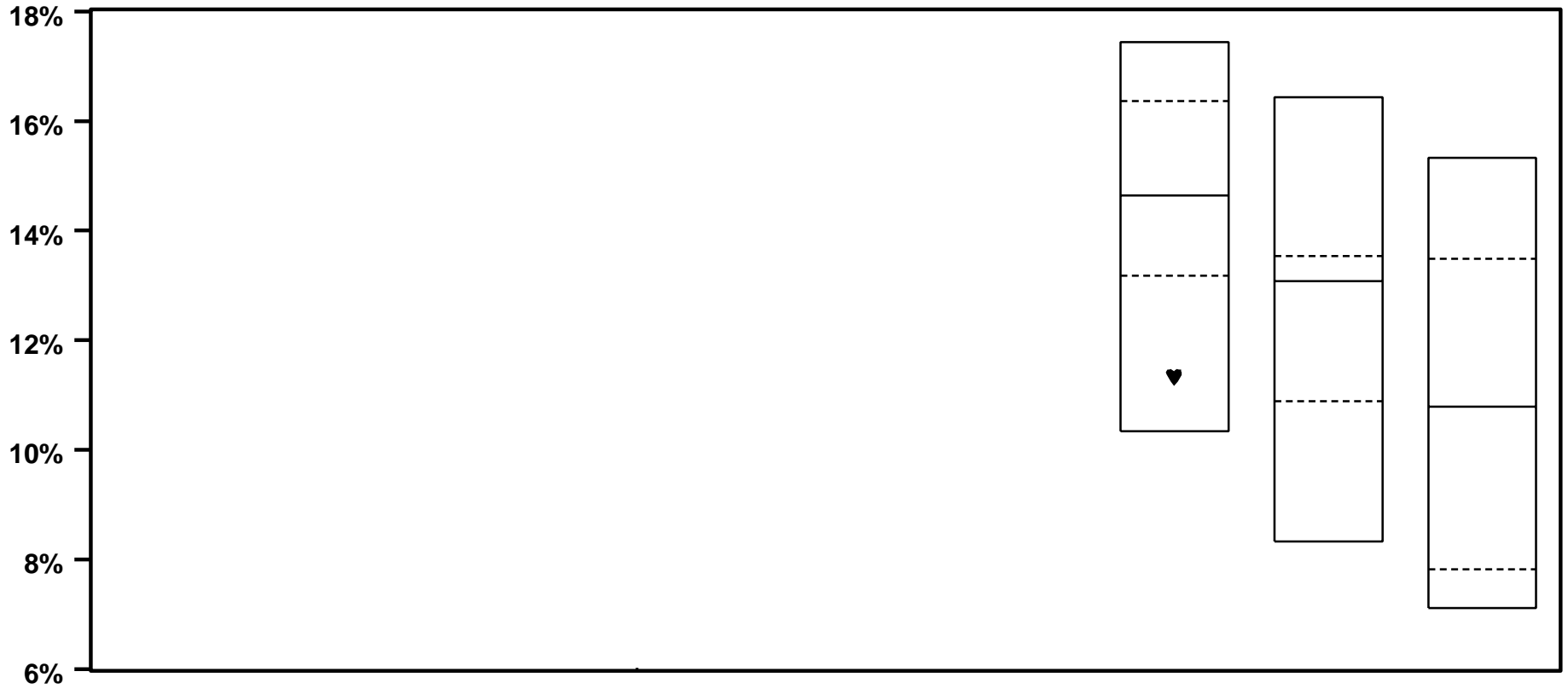

	LARGE VALUE	LARGE CORE	LARGE GROWTH
♥ UBS	11.3	13.1	10.8
MEDIAN	14.6	13.1	10.8

VERMONT MUNICIPAL EMPLOYEES

INT'L DEVELOPED MKT EQUITY MANAGER STYLE ANALYSIS - TOTAL RETURNS

FOUR YEARS ENDING 6/05

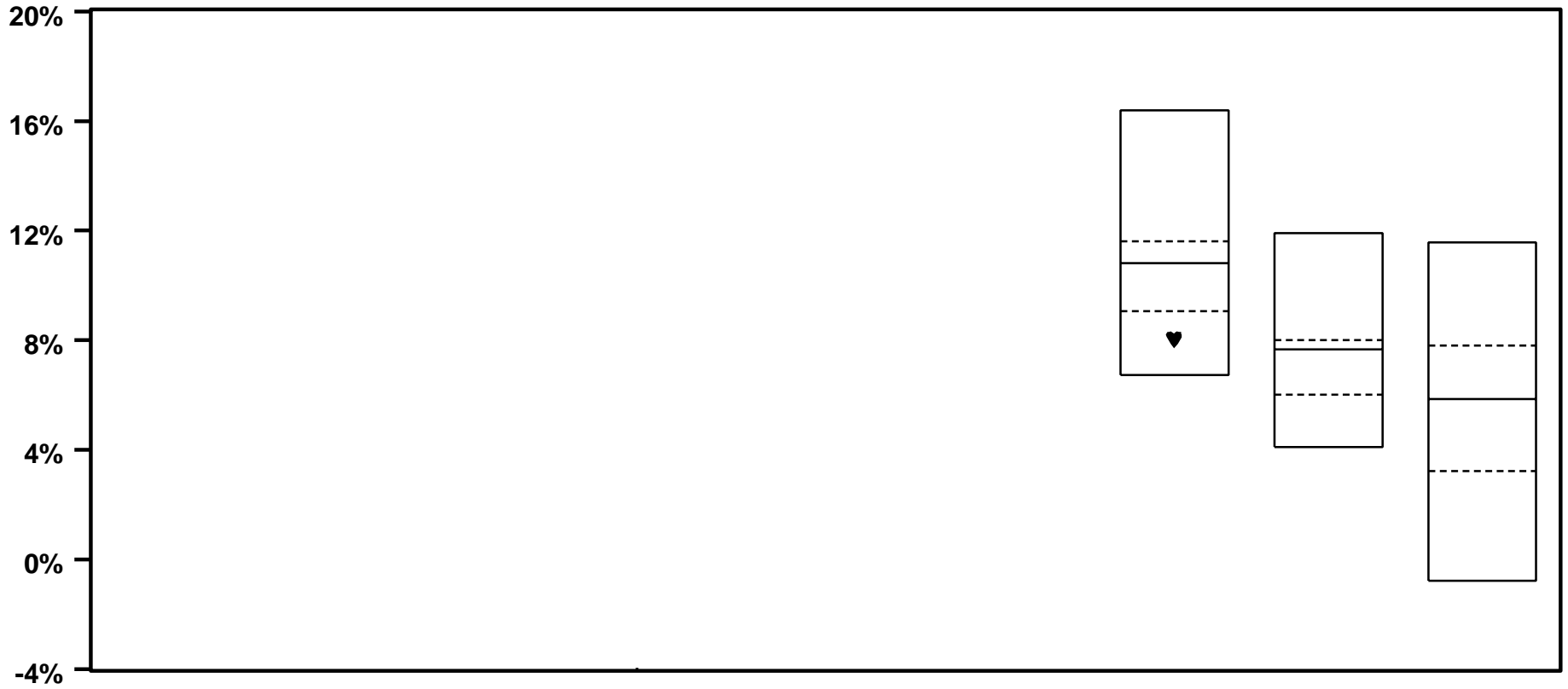

	LARGE VALUE		LARGE CORE	LARGE GROWTH
♥ UBS	8.0	90		
MEDIAN	10.8		7.7	5.9

VERMONT MUNICIPAL EMPLOYEES

INT'L DEVELOPED MKT EQUITY MANAGER STYLE ANALYSIS - TOTAL RETURNS

FIVE YEARS ENDING 6/05

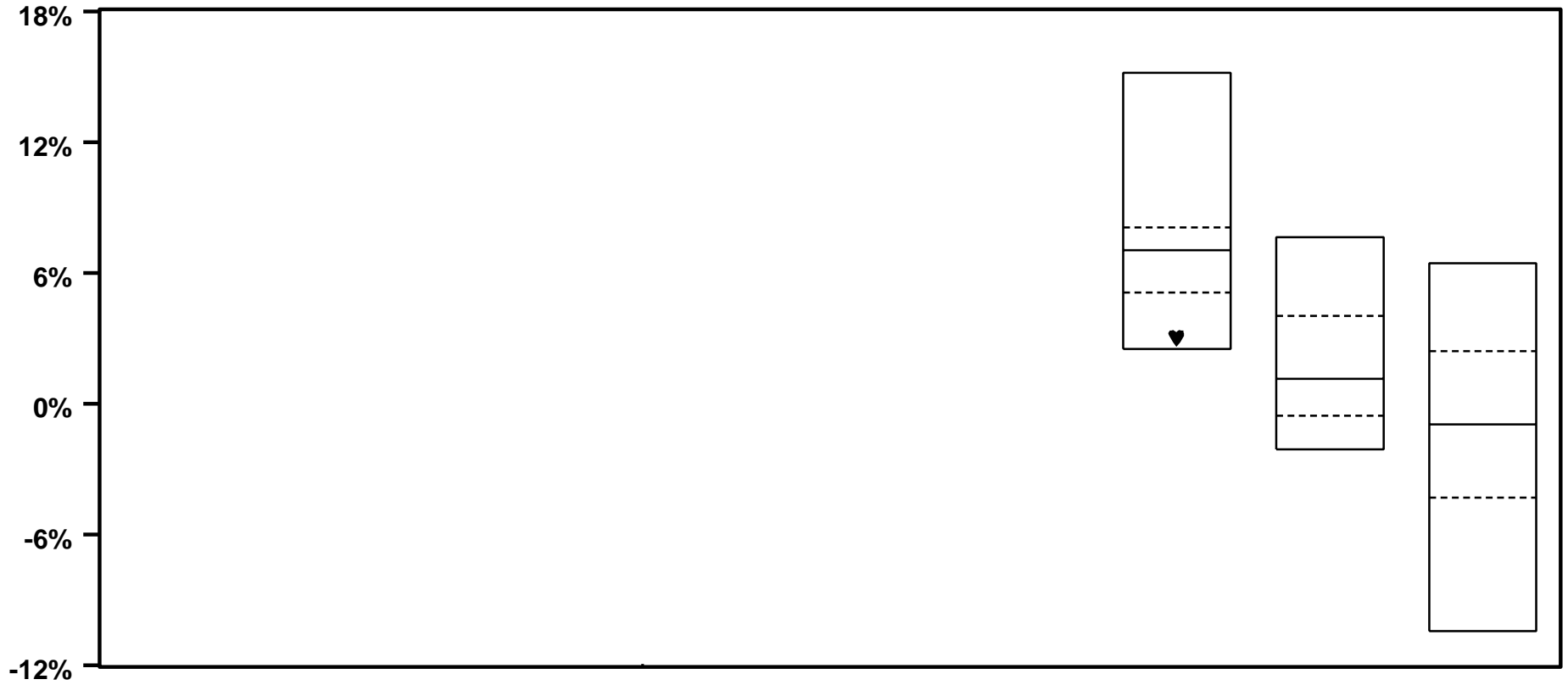

	LARGE VALUE	LARGE CORE	LARGE GROWTH
♥ UBS	3.0		
MEDIAN	7.0	1.1	-0.9

VERMONT MUNICIPAL EMPLOYEES

INT'L DEVELOPED MKT EQUITY MANAGER STYLE ANALYSIS - TOTAL RETURNS

YEAR ENDING 6/04

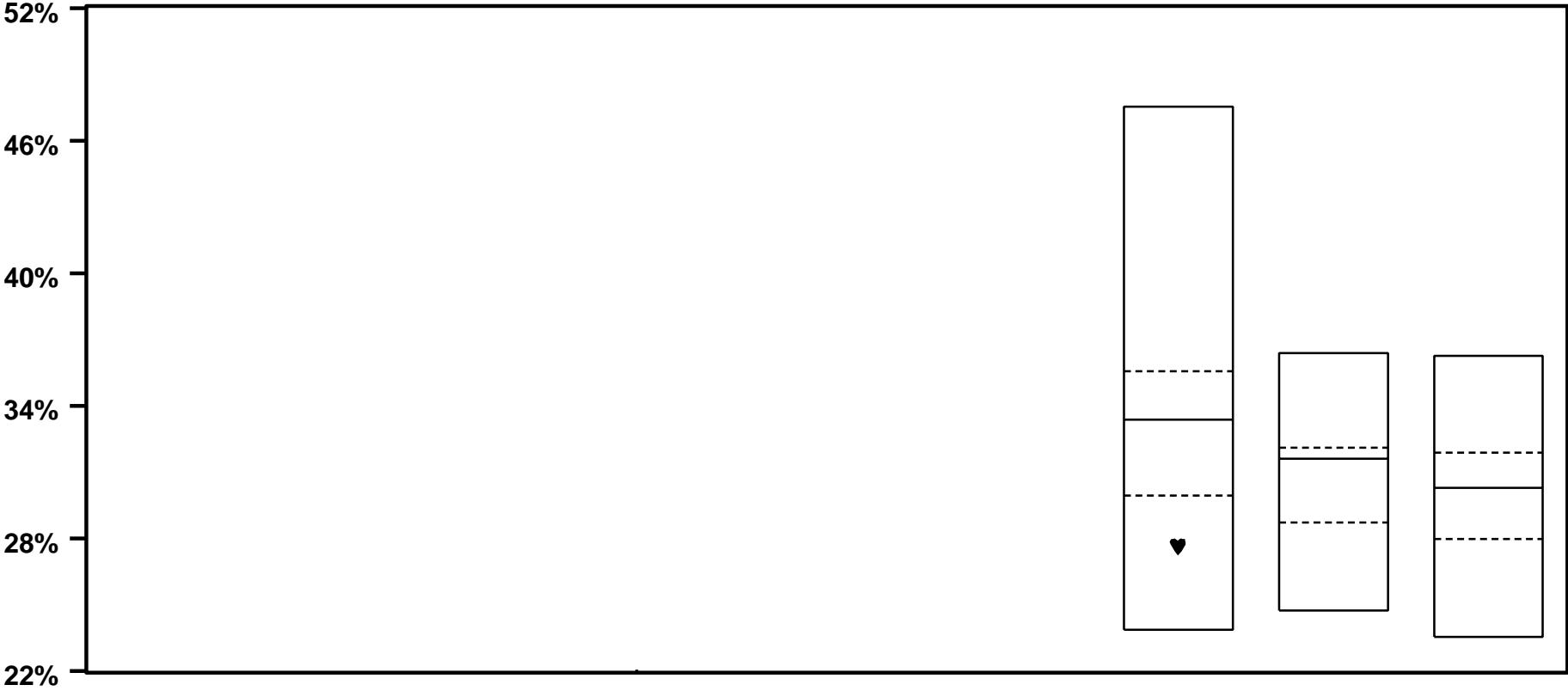

	LARGE VALUE	LARGE CORE	LARGE GROWTH
♥ UBS	27.7		
MEDIAN	33.4	31.6	30.3

VERMONT MUNICIPAL EMPLOYEES

INT'L DEVELOPED MKT EQUITY MANAGER STYLE ANALYSIS - TOTAL RETURNS

YEAR ENDING 6/03

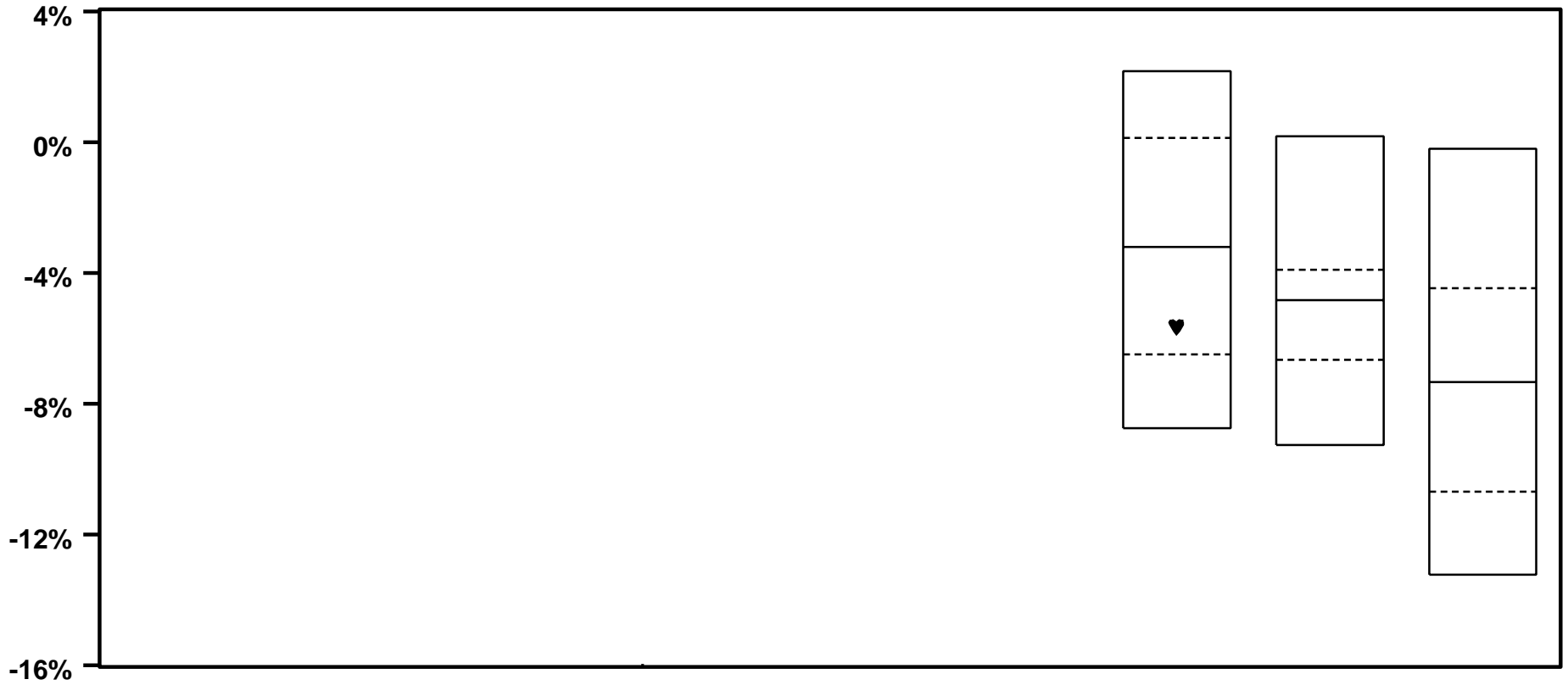

	LARGE VALUE	LARGE CORE	LARGE GROWTH
♥ UBS	- 5.6		
MEDIAN	- 3.2	- 4.8	- 7.3

VERMONT MUNICIPAL EMPLOYEES

INT'L DEVELOPED MKT EQUITY MANAGER STYLE ANALYSIS - TOTAL RETURNS

YEAR ENDING 6/02

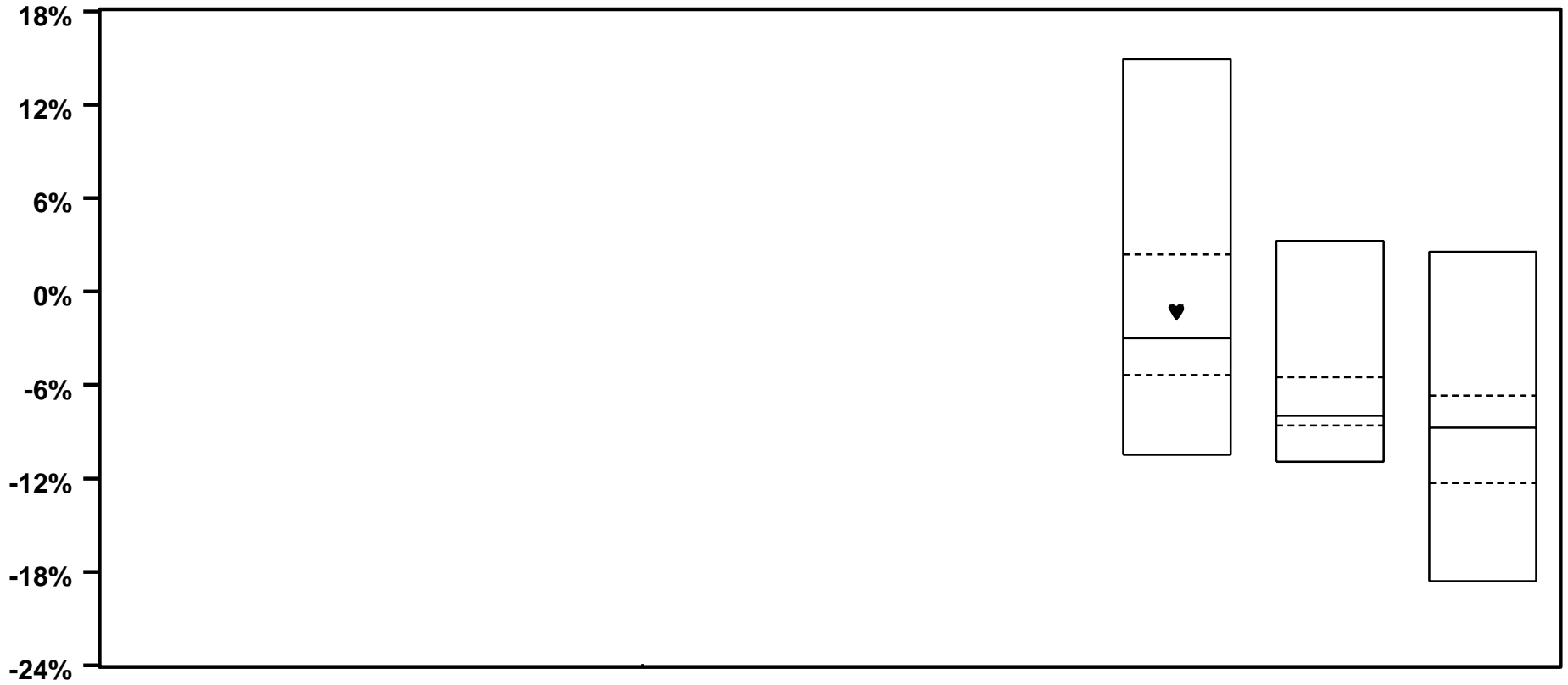

	LARGE VALUE	LARGE CORE	LARGE GROWTH
♥ UBS	- 1.3		
MEDIAN	- 3.0	- 8.0	- 8.7

VERMONT MUNICIPAL EMPLOYEES

INT'L DEVELOPED MKT EQUITY MANAGER STYLE ANALYSIS - TOTAL RETURNS

YEAR ENDING 6/01

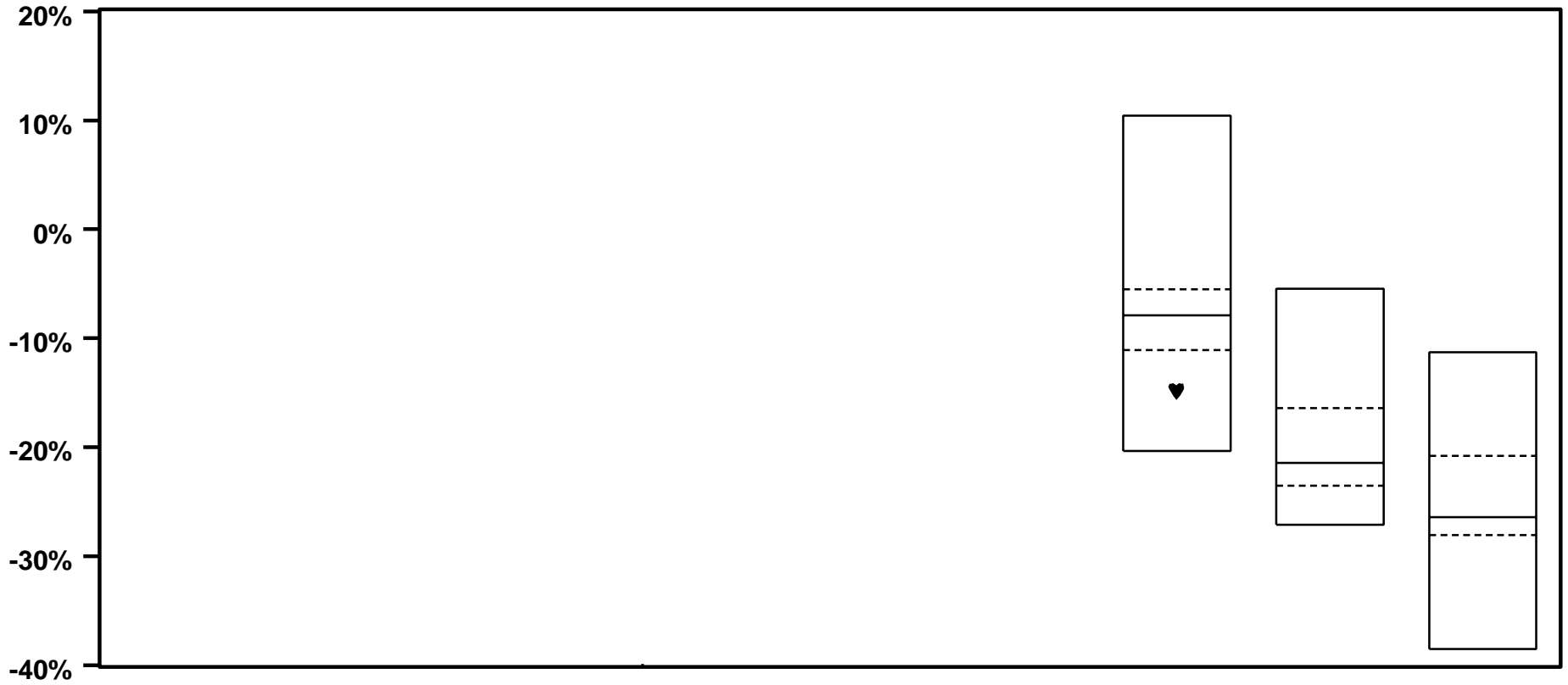

	LARGE VALUE	LARGE CORE	LARGE GROWTH
♥ UBS	- 14.8		
MEDIAN	- 7.9	- 21.4	- 26.4

VERMONT MUNICIPAL EMPLOYEES

INT'L DEVELOPED MKT EQUITY MANAGER STYLE ANALYSIS - TOTAL RETURNS

YEAR ENDING 6/00

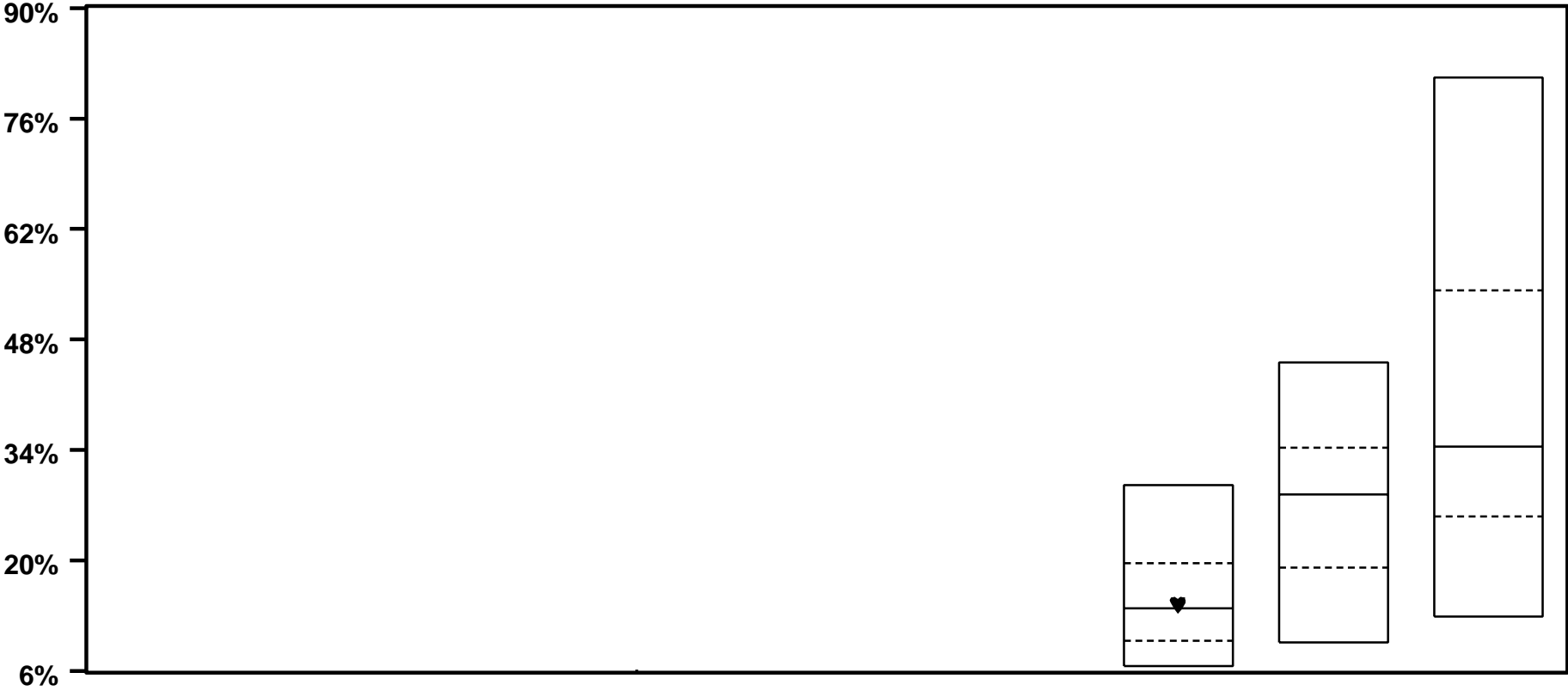

LARGE VALUE	LARGE CORE	LARGE GROWTH
14.4	28.4	34.4

LARGE VALUE	LARGE CORE	LARGE GROWTH
13.9	28.4	34.4

♥ UBS

MEDIAN

VERMONT MUNICIPAL EMPLOYEES

BOND SUMMARY STATISTICS

QUARTER ENDING 6/05

MUNICIPAL SYSTEM COMPOSITE

	PORTFOLIO	LB AGGREGATE
TOTAL NUMBER OF SECURITIES	389	
TOTAL MARKET VALUE	\$ 77,676,597	
CURRENT COUPON	5.33	5.21
YIELD TO MATURITY	4.37	4.51
AVERAGE MATURITY	6.22	6.79
DURATION	4.12	4.16
QUALITY	9.16	8.50

YIELD TO MATURITY	% HELD
0.0 - 5.0	75.2
5.0 - 7.0	13.8
7.0 - 9.0	3.7
9.0 - 11.0	0.1
11.0 - 13.0	0.0
13.0+	0.0
UNCLASSIFIED	7.2

AVERAGE MATURITY	% HELD
0.0 - 1.0	9.2
1.0 - 3.0	28.6
3.0 - 5.0	21.3
5.0 - 10.0	24.2
10.0 - 20.0	0.4
20.0+	9.1
UNCLASSIFIED	7.2

DURATION YEARS	% HELD
0.0 - 1.0	11.9
1.0 - 3.0	34.0
3.0 - 4.0	14.9
4.0 - 6.0	7.6
6.0 - 8.0	14.2
8.0+	9.2
UNCLASSIFIED	7.2

QUALITY	% HELD
GOVT (10)	65.0
Aaa (10)	11.3
Aa (9)	2.0
A (8)	2.5
Baa (7)	5.3
Below Baa (6 - 1)	13.5
Other	0.4

COUPON	% HELD
0.0 - 5.0	47.7
5.0 - 7.0	35.1
7.0 - 9.0	10.6
9.0 - 11.0	6.4
11.0 - 13.0	0.3
13.0+	0.0
UNCLASSIFIED	0.0

VERMONT MUNICIPAL EMPLOYEES

BOND SUMMARY STATISTICS

QUARTER ENDING 6/05

SEIX CORE

	PORTFOLIO	LB AGGREGATE
TOTAL NUMBER OF SECURITIES	146	
TOTAL MARKET VALUE	\$ 67,218,331	
CURRENT COUPON	4.86	5.21
YIELD TO MATURITY	4.03	4.51
AVERAGE MATURITY	6.12	6.79
DURATION	4.08	4.16
QUALITY	9.74	8.50

YIELD TO MATURITY	% HELD
0.0 - 5.0	86.1
5.0 - 7.0	5.2
7.0 - 9.0	0.4
9.0 - 11.0	0.0
11.0 - 13.0	0.0
13.0+	0.0
UNCLASSIFIED	8.3

AVERAGE MATURITY	% HELD
0.0 - 1.0	10.1
1.0 - 3.0	29.2
3.0 - 5.0	21.0
5.0 - 10.0	21.8
10.0 - 20.0	0.2
20.0+	9.3
UNCLASSIFIED	8.3

DURATION YEARS	% HELD
0.0 - 1.0	13.1
1.0 - 3.0	34.9
3.0 - 4.0	14.6
4.0 - 6.0	3.3
6.0 - 8.0	15.4
8.0+	9.3
UNCLASSIFIED	8.3

QUALITY	% HELD
GOVT (10)	75.1
Aaa (10)	13.0
Aa (9)	2.3
A (8)	2.9
Baa (7)	5.9
Below Baa (6 - 1)	0.2
Other	0.5

COUPON	% HELD
0.0 - 5.0	55.0
5.0 - 7.0	38.0
7.0 - 9.0	3.2
9.0 - 11.0	3.8
11.0 - 13.0	0.0
13.0+	0.0
UNCLASSIFIED	0.0

VERMONT MUNICIPAL EMPLOYEES

BOND SUMMARY STATISTICS

QUARTER ENDING 6/05

SEIX HIGH YIELD

	PORTFOLIO	CITI BB&B ALL
TOTAL NUMBER OF SECURITIES	243	
TOTAL MARKET VALUE	\$ 10,458,266	
CURRENT COUPON	8.32	
YIELD TO MATURITY	6.28	
AVERAGE MATURITY	6.79	
DURATION	4.31	
QUALITY	5.45	

YIELD TO MATURITY	% HELD
0.0 - 5.0	5.2
5.0 - 7.0	69.1
7.0 - 9.0	24.9
9.0 - 11.0	0.8
11.0 - 13.0	0.0
13.0+	0.0
UNCLASSIFIED	0.0

AVERAGE MATURITY	% HELD
0.0 - 1.0	3.6
1.0 - 3.0	24.7
3.0 - 5.0	23.5
5.0 - 10.0	39.1
10.0 - 20.0	1.1
20.0+	8.0
UNCLASSIFIED	0.0

DURATION YEARS	% HELD
0.0 - 1.0	4.1
1.0 - 3.0	28.4
3.0 - 4.0	16.7
4.0 - 6.0	35.3
6.0 - 8.0	6.9
8.0+	8.5
UNCLASSIFIED	0.0

QUALITY	% HELD
GOVT (10)	0.0
Aaa (10)	0.0
Aa (9)	0.0
A (8)	0.0
Baa (7)	1.4
Below Baa (6 - 1)	98.6
Other	0.0

COUPON	% HELD
0.0 - 5.0	0.5
5.0 - 7.0	16.3
7.0 - 9.0	57.6
9.0 - 11.0	23.4
11.0 - 13.0	2.2
13.0+	0.0
UNCLASSIFIED	0.0

VERMONT MUNICIPAL EMPLOYEES

BOND PORTFOLIO CHARACTERISTICS

PERIODS ENDING 6/05

AVERAGE MATURITY (YRS)

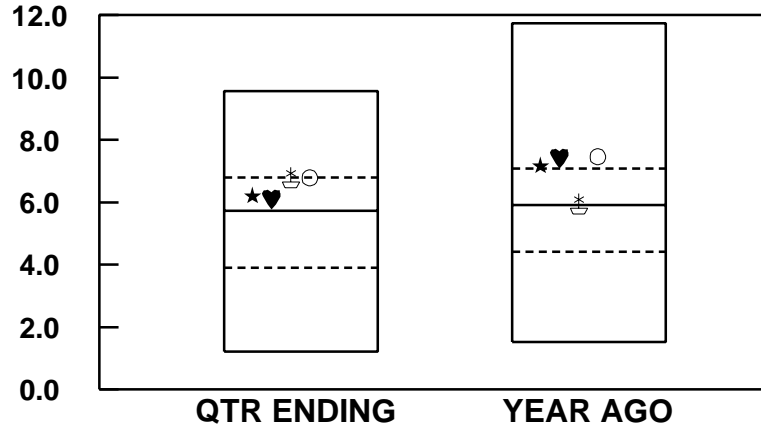

DURATION (YRS)

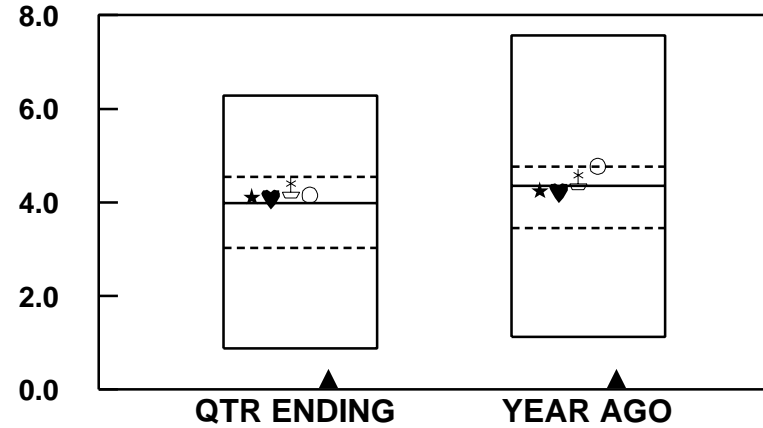

EFFECTS ON RETURN

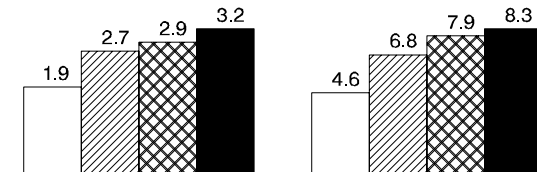
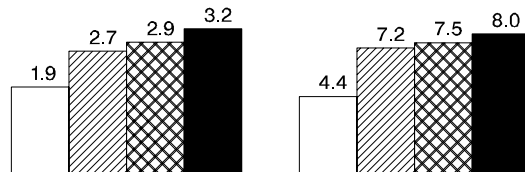
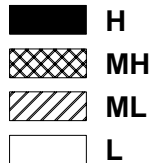

★ MUNI COMPOSITE	6.22	36	7.19	23	4.12	41	4.26	53
♥ SEIX CORE	6.12	38	7.43	20	4.08	42	4.21	54
⊕ SEIX HIGH YIELD	6.79	25	5.95	45	4.31	33	4.49	38
○ LB AGGREGATE	6.79	25	7.47	18	4.16	40	4.77	24
▲ 90 DAY T-BILLS					0.25	97	0.25	97
MEDIAN	5.73		5.92		3.98		4.35	

VERMONT MUNICIPAL EMPLOYEES

BOND PORTFOLIO CHARACTERISTICS

PERIODS ENDING 6/05

COUPON

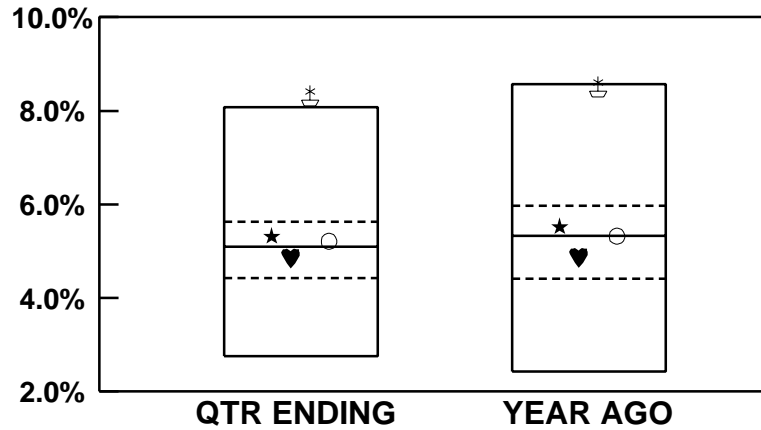

QUALITY

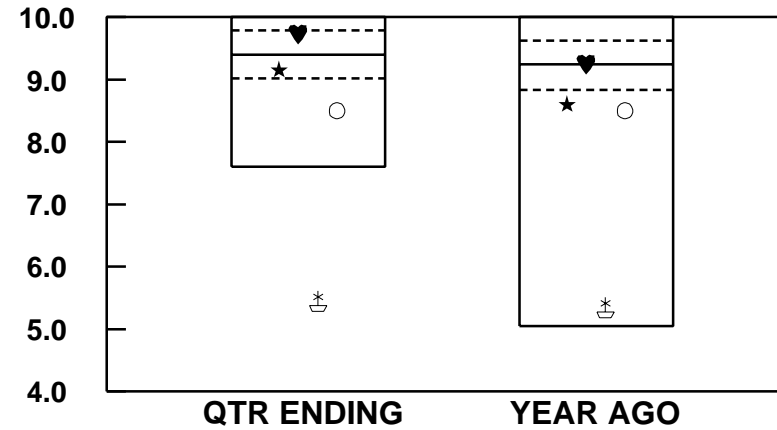

EFFECTS ON RETURN

- H
- MH
- ML
- L

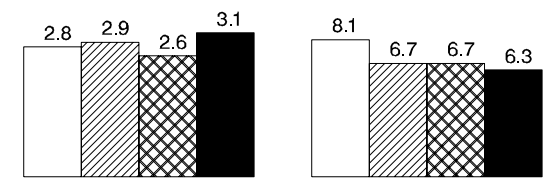
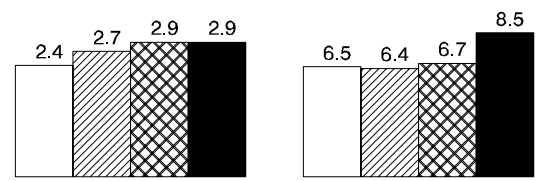

★ MUNI COMPOSITE	5.33	35	5.53	40	9.16	67	8.61	79
♥ SEIX CORE	4.86	61	4.87	64	9.74	27	9.25	48
⌘ SEIX HIGH YIELD	8.32	2	8.51	6	5.45	99	5.35	91
○ LB AGGREGATE	5.21	42	5.32	48	8.50	90	8.50	81
MEDIAN	5.09		5.32		9.40		9.24	

VERMONT MUNICIPAL EMPLOYEES
FIXED INCOME SECTOR ALLOCATION
AS OF JUNE 30, 2005

MUNICIPAL SYSTEM COMPOSITE

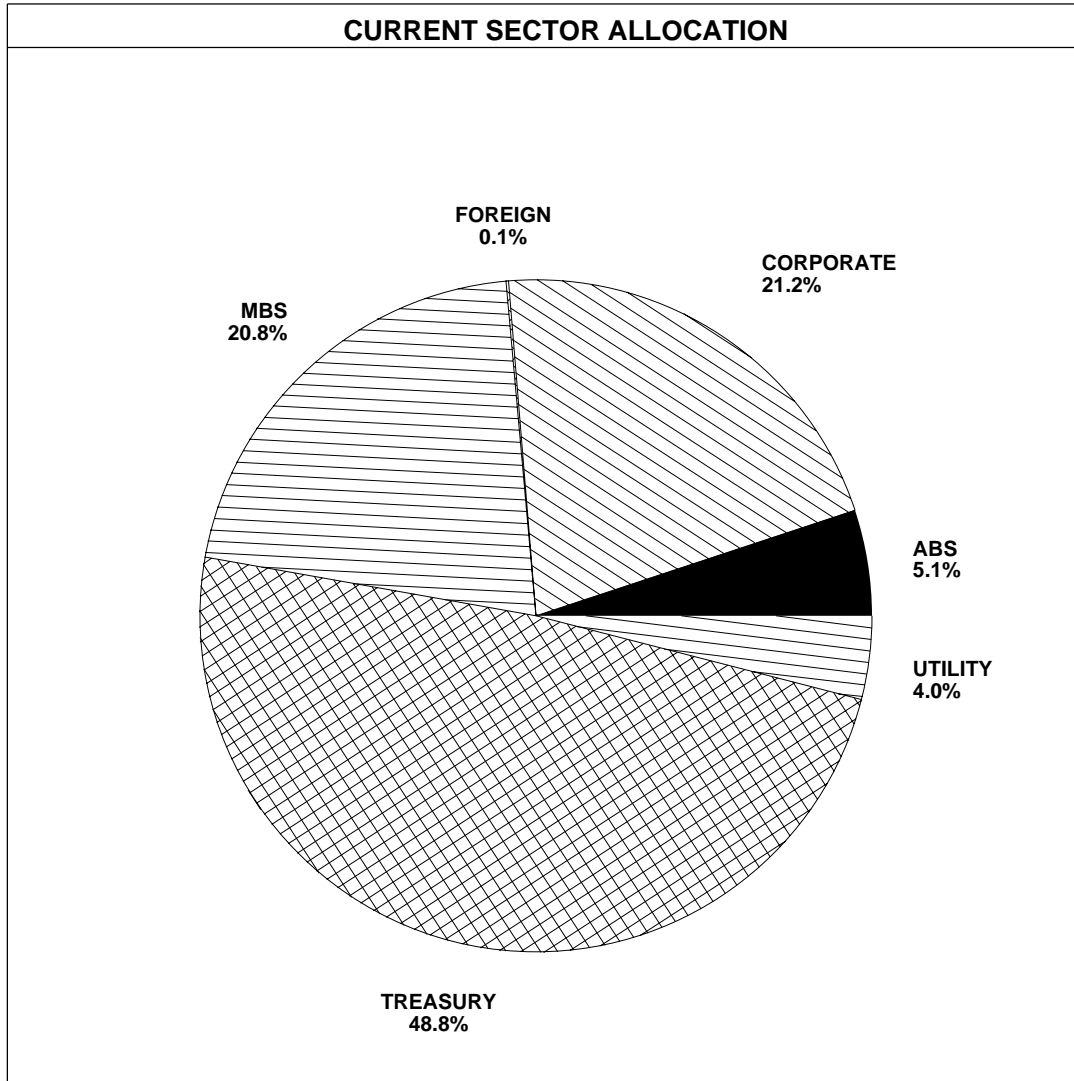

<u>SECTOR</u>	<u>ACCOUNT WEIGHT</u>	<u>INDEX WEIGHT</u>	<u>DIFFERENCE</u>
TREASURIES	48.8%	26.3%	22.5%
AGENCIES	0.0%	11.1%	-11.1%
CORPORATES	21.2%	18.1%	3.1%
UTILITIES	4.0%	1.8%	2.2%
FOREIGN	0.1%	4.2%	-4.1%
MBS	20.8%	33.8%	-13.0%
CMO	0.0%	0.0%	0.0%
ABS	5.1%	4.8%	0.3%
MUNICIPALS	0.0%	0.0%	0.0%
OTHERS	0.0%	0.0%	0.0%
TOTAL	100.0%	100.0%	0.0%

Benchmark: LB AGGREGATE

VERMONT MUNICIPAL EMPLOYEES

FIXED INCOME SECTOR ALLOCATION

AS OF JUNE 30, 2005

SEIX CORE

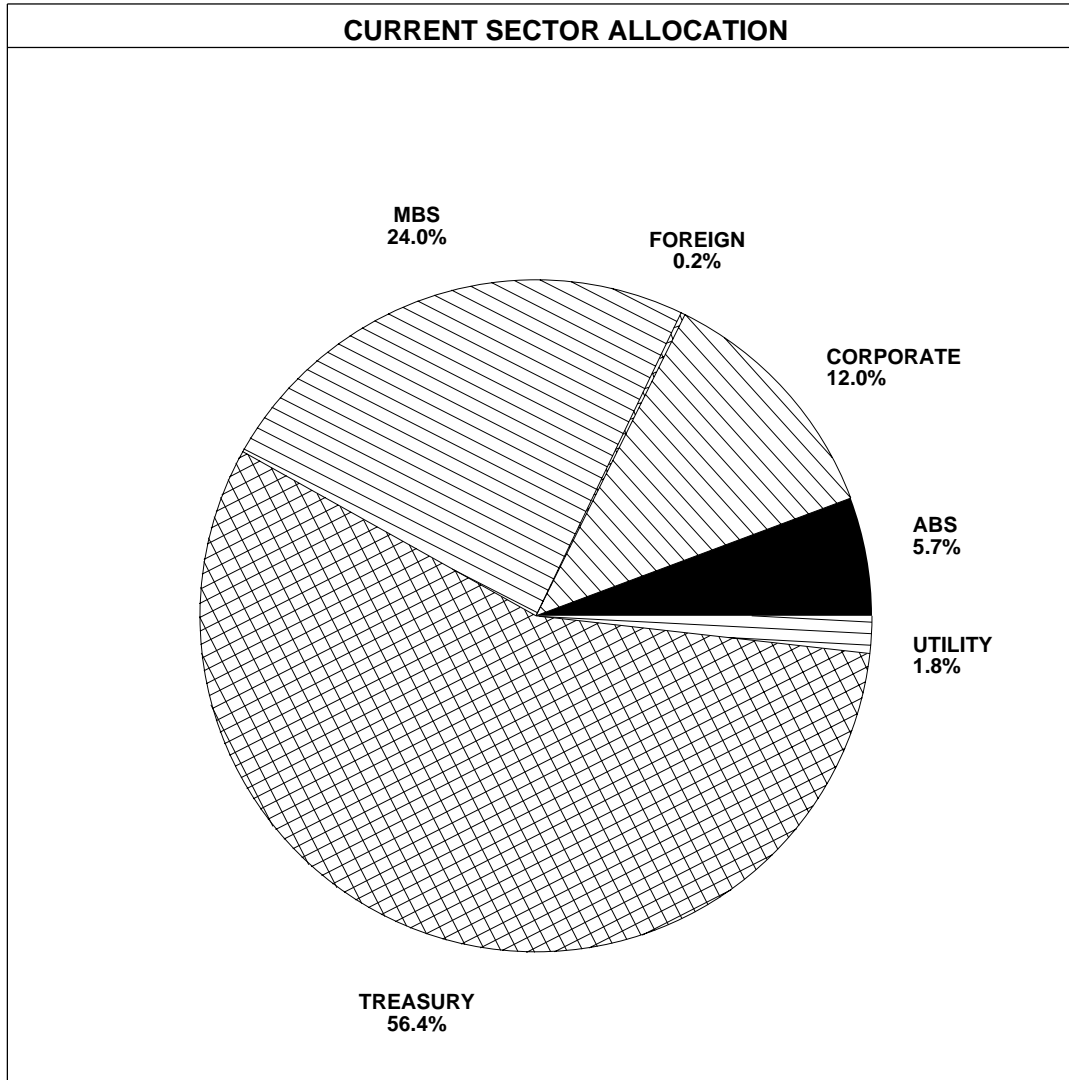

<u>SECTOR</u>	<u>ACCOUNT WEIGHT</u>	<u>INDEX WEIGHT</u>	<u>DIFFERENCE</u>
TREASURIES	56.4%	26.3%	30.1%
AGENCIES	0.0%	11.1%	-11.1%
CORPORATES	12.0%	18.1%	-6.0%
UTILITIES	1.8%	1.8%	0.0%
FOREIGN	0.2%	4.2%	-4.0%
MBS	24.0%	33.8%	-9.8%
CMO	0.0%	0.0%	0.0%
ABS	5.7%	4.8%	0.9%
MUNICIPALS	0.0%	0.0%	0.0%
OTHERS	0.0%	0.0%	0.0%
TOTAL	100.0%	100.0%	0.0%

Benchmark: LB AGGREGATE

**VERMONT MUNICIPAL EMPLOYEES
FIXED INCOME SECTOR ALLOCATION
AS OF JUNE 30, 2005**

SEIX HIGH YIELD

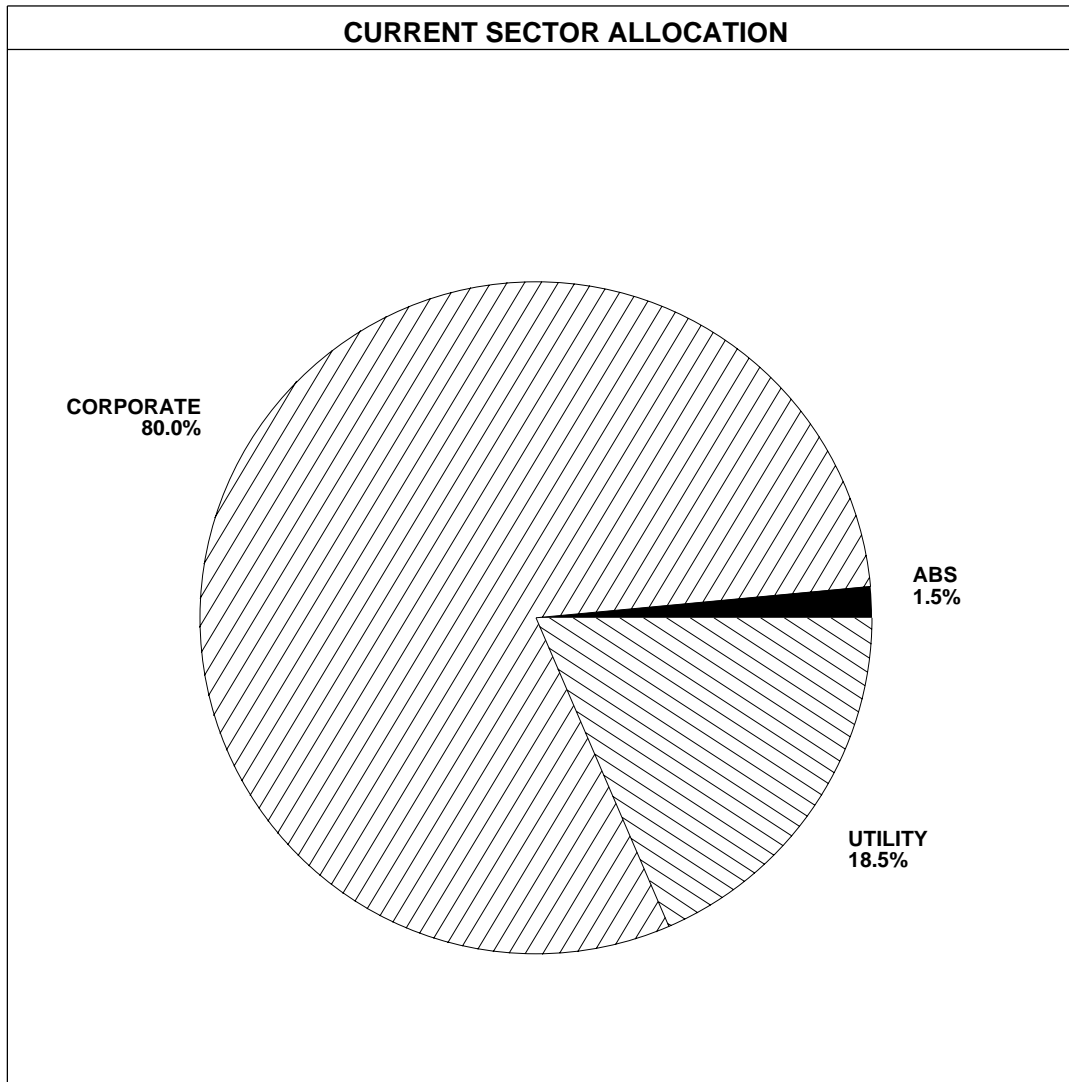

<u>SECTOR</u>	<u>ACCOUNT WEIGHT</u>	<u>INDEX WEIGHT</u>	<u>DIFFERENCE</u>
TREASURIES	0.0%	N/ A	N/ A
AGENCIES	0.0%	N/ A	N/ A
CORPORATES	80.0%	N/ A	N/ A
UTILITIES	18.5%	N/ A	N/ A
FOREIGN	0.0%	N/ A	N/ A
MBS	0.0%	N/ A	N/ A
CMO	0.0%	N/ A	N/ A
ABS	1.5%	N/ A	N/ A
MUNICIPALS	0.0%	N/ A	N/ A
OTHERS	0.0%	N/ A	N/ A
TOTAL	100.0%	N/ A	N/ A

Benchmark: CITI BB&B ALL

VERMONT MUNICIPAL EMPLOYEES

DURATION LINE ANALYSIS

QUARTER ENDING 6/05

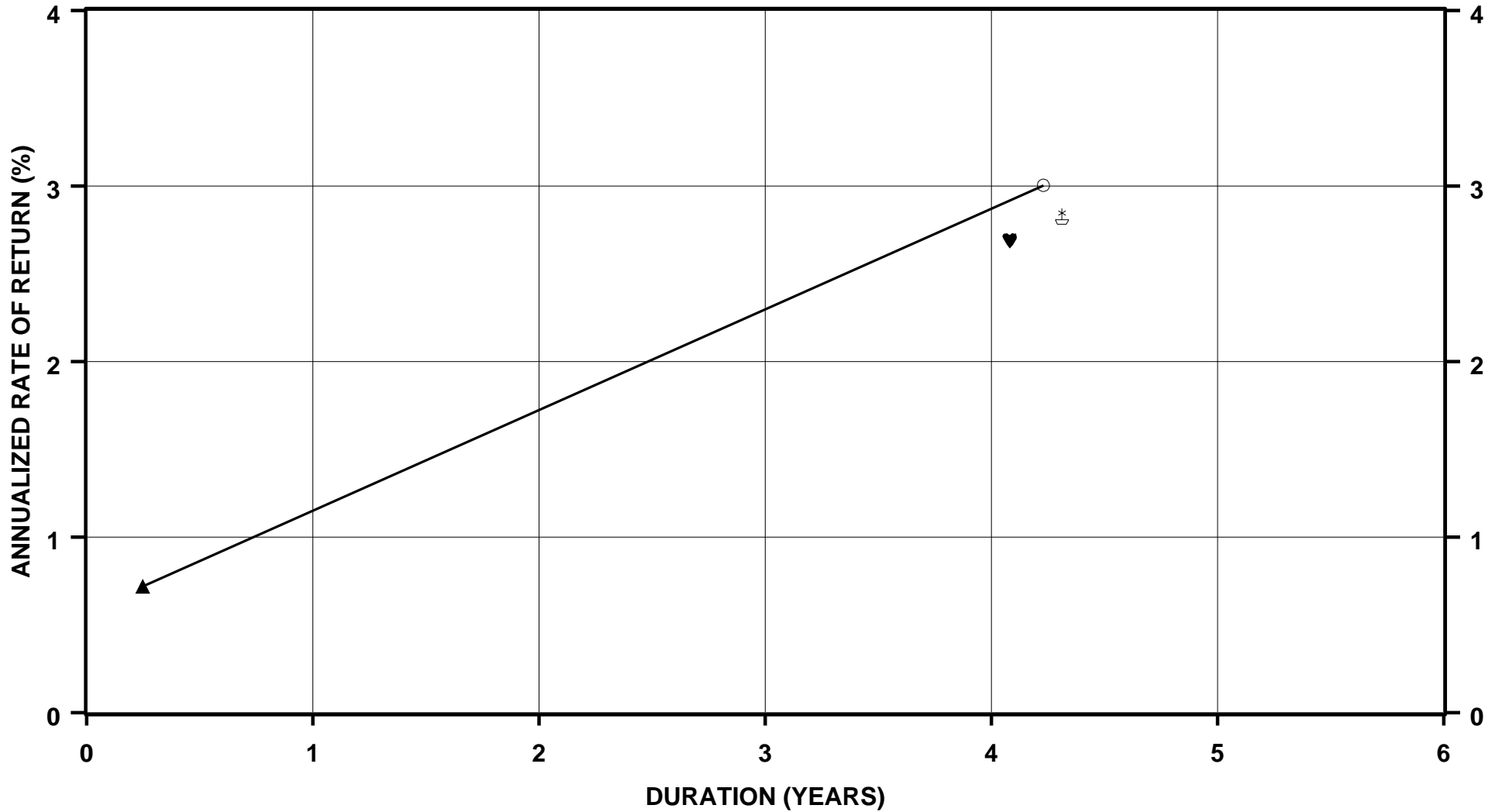

♥ SEIX CORE ☪ SEIX HIGH YIELD ○ LB AGGREGATE
▲ 90 DAY T-BILLS

VERMONT MUNICIPAL EMPLOYEES
FIXED INCOME ATTRIBUTION - BOND FUNDS
QUARTER ENDING 6/05

<u>MANAGER</u>	<u>RETURN</u>	<u>BEGINNING DURATION</u>	<u>ENDING DURATION</u>	<u>AVERAGE DURATION</u>	<u>RETURN DUE TO MARKET</u>	<u>INTEREST RATE ANTICIPATION</u>	<u>SECURITY SELECTION</u>
SEIX CORE	2.69	3.64	4.08	3.86	2.83	0.13	-0.27
SEIX HIGH YIELD	2.83	4.00	4.31	4.16	3.00	0.09	-0.27
<u>BENCHMARKS</u>							
LB AGGREGATE	3.00	4.50	4.16	4.30			
90 DAY T-BILLS	0.72	0.25	0.25	0.25			
MARKET SENSITIVITY	0.58						

Due to Market = T-Bill return + (relative market sensitivity x (average duration - T-Bill duration))

Rate Anticipation = relative market sensitivity x current duration - average duration

Selection Effect = (account return - T-Bill return) - (relative market sensitivity x (current duration - T-Bill duration))

Relative Market Sensitivity = (Benchmark return - T-Bill return) / (Benchmark current duration - T-Bill duration)

Duration = Duration Option Adjusted Incl Cash Equiv

VERMONT MUNICIPAL EMPLOYEES
FIXED INCOME ATTRIBUTION - BOND ONLY
QUARTER ENDING 6/05

<u>MANAGER</u>	<u>RETURN</u>	<u>BEGINNING DURATION</u>	<u>ENDING DURATION</u>	<u>AVERAGE DURATION</u>	<u>RETURN DUE TO MARKET</u>	<u>INTEREST RATE ANTICIPATION</u>	<u>SECURITY SELECTION</u>
MUNI COMPOSITE	2.71	3.69	4.12	3.91	2.85	0.12	-0.26
SEIX CORE	2.70	3.64	4.08	3.86	2.83	0.13	-0.26
SEIX HIGH YIELD	2.83	4.00	4.31	4.16	3.00	0.09	-0.27
<u>BENCHMARKS</u>							
LB AGGREGATE	3.00	4.50	4.16	4.30			
90 DAY T-BILLS	0.72	0.25	0.25	0.25			
MARKET SENSITIVITY	0.58						

Due to Market = T-Bill return + (relative market sensitivity x (average duration - T-Bill duration))

Rate Anticipation = relative market sensitivity x current duration - average duration

Selection Effect = (account return - T-Bill return) - (relative market sensitivity x (current duration - T-Bill duration))

Relative Market Sensitivity = (Benchmark return - T-Bill return) / (Benchmark current duration - T-Bill duration)

Duration = Duration Option Adjusted

VERMONT MUNICIPAL EMPLOYEES

BOND ONLY - RATES OF RETURN

COMPARED TO FUNDS WITH SIMILAR MATURITY

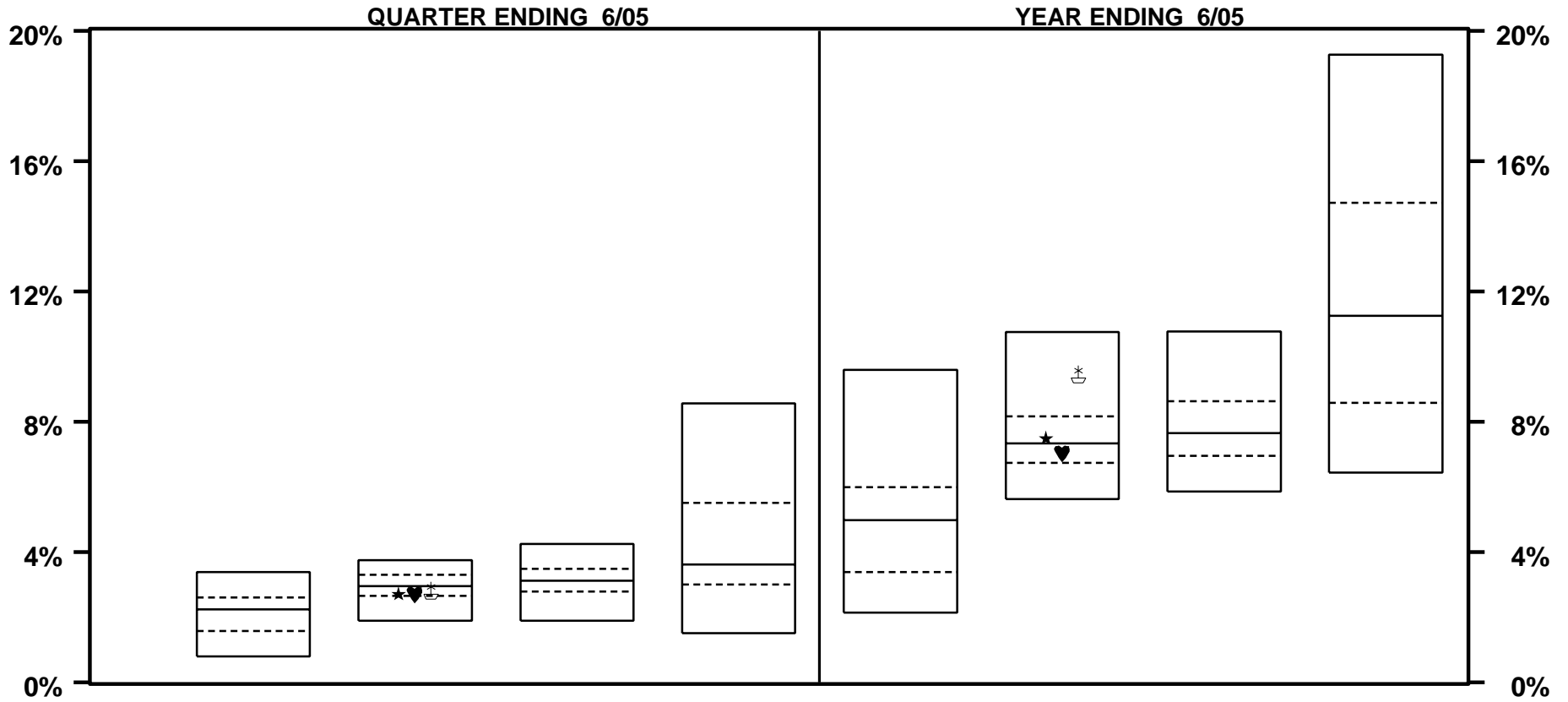

	QUARTER ENDING 6/05				YEAR ENDING 6/05			
	BELOW 5 YEARS	5-7 YEARS	7-9 YEARS	ABOVE 9 YEARS	BELOW 5 YEARS	5-7 YEARS	7-9 YEARS	ABOVE 9 YEARS
★ MUNI COMPOSITE		2.7 70				7.5 44		
♥ SEIX CORE		2.7 71				7.0 62		
⚓ SEIX HIGH YIELD		2.8 61				9.5 9		
MEDIAN	2.2	3.0	3.1	3.6	5.0	7.3	7.6	11.3

VERMONT MUNICIPAL EMPLOYEES

BOND ONLY - RATES OF RETURN

COMPARED TO FUNDS WITH SIMILAR MATURITY

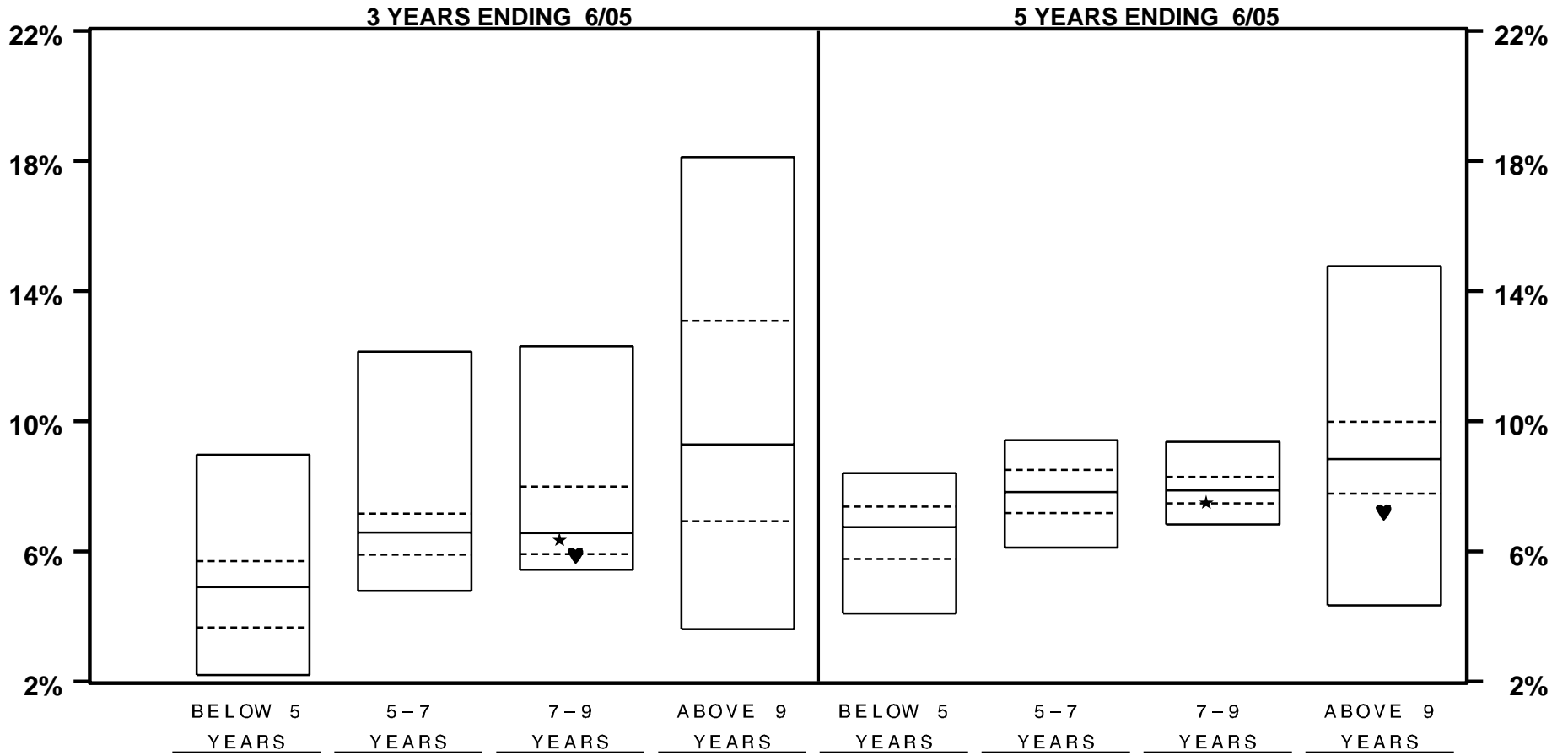

★ MUNI COMPOSITE
♥ SEIX CORE

	BELOW 5 YEARS		5-7 YEARS		7-9 YEARS		ABOVE 9 YEARS	
MUNICIPAL			6.4	60			7.5	73
SEIX CORE			5.9	78				82
MEDIAN	4.9	6.6	6.6	9.3	6.8	7.8	7.9	8.8

VERMONT MUNICIPAL EMPLOYEES

BOND ONLY - RATES OF RETURN

COMPARED TO FUNDS WITH SIMILAR DURATION

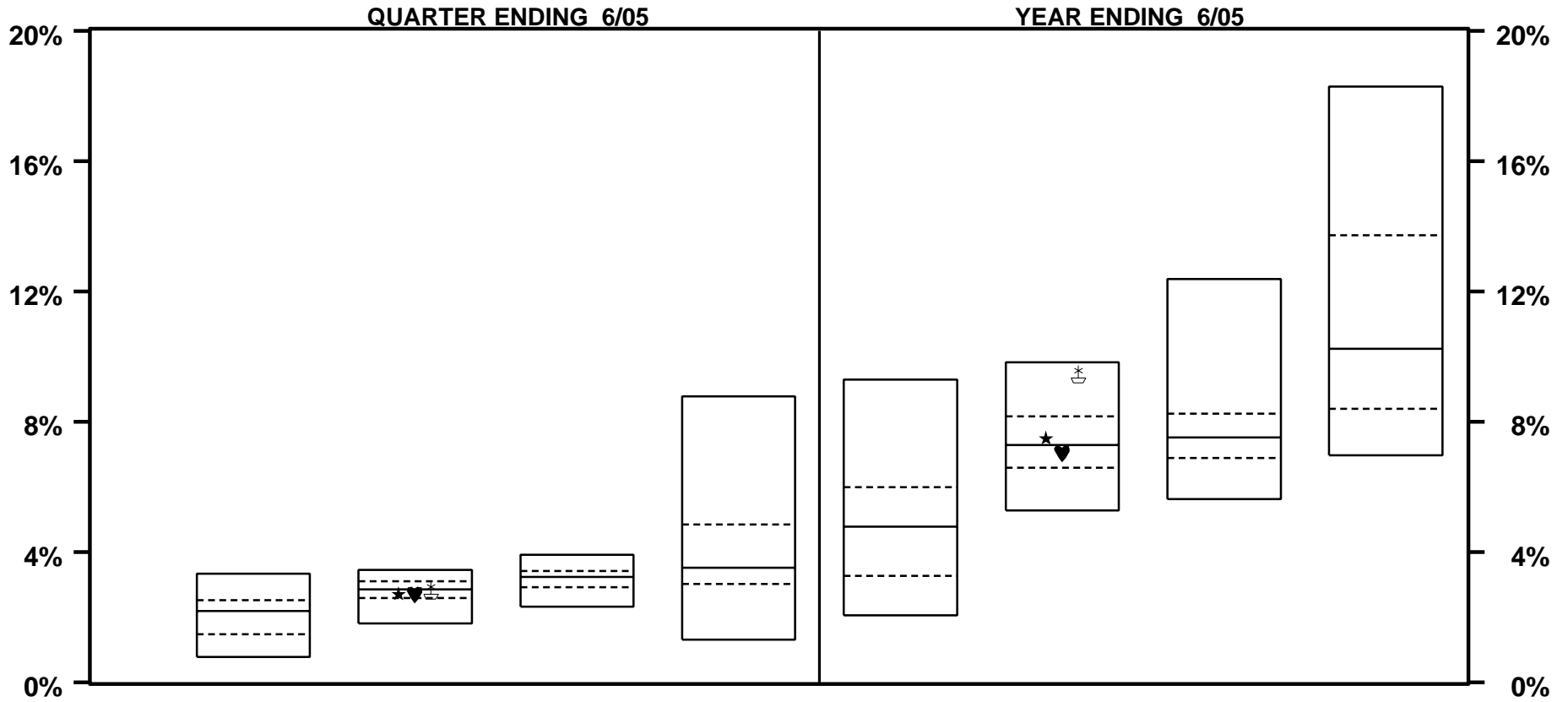

	QUARTER ENDING 6/05				YEAR ENDING 6/05			
	BELOW 3.5	3.5-4.5	4.5-5.5	ABOVE 5.5	BELOW 3.5	3.5-4.5	4.5-5.5	ABOVE 5.5
	YEARS				YEARS			
★ MUNI COMPOSITE		2.7				7.5		
♥ SEIX CORE		2.7				7.0		
⚡ SEIX HIGH YIELD		2.8				9.5		
MEDIAN	2.2	2.9	3.2	3.5	4.8	7.3	7.5	10.2

VERMONT MUNICIPAL EMPLOYEES

BOND ONLY - RATES OF RETURN

COMPARED TO FUNDS WITH SIMILAR DURATION

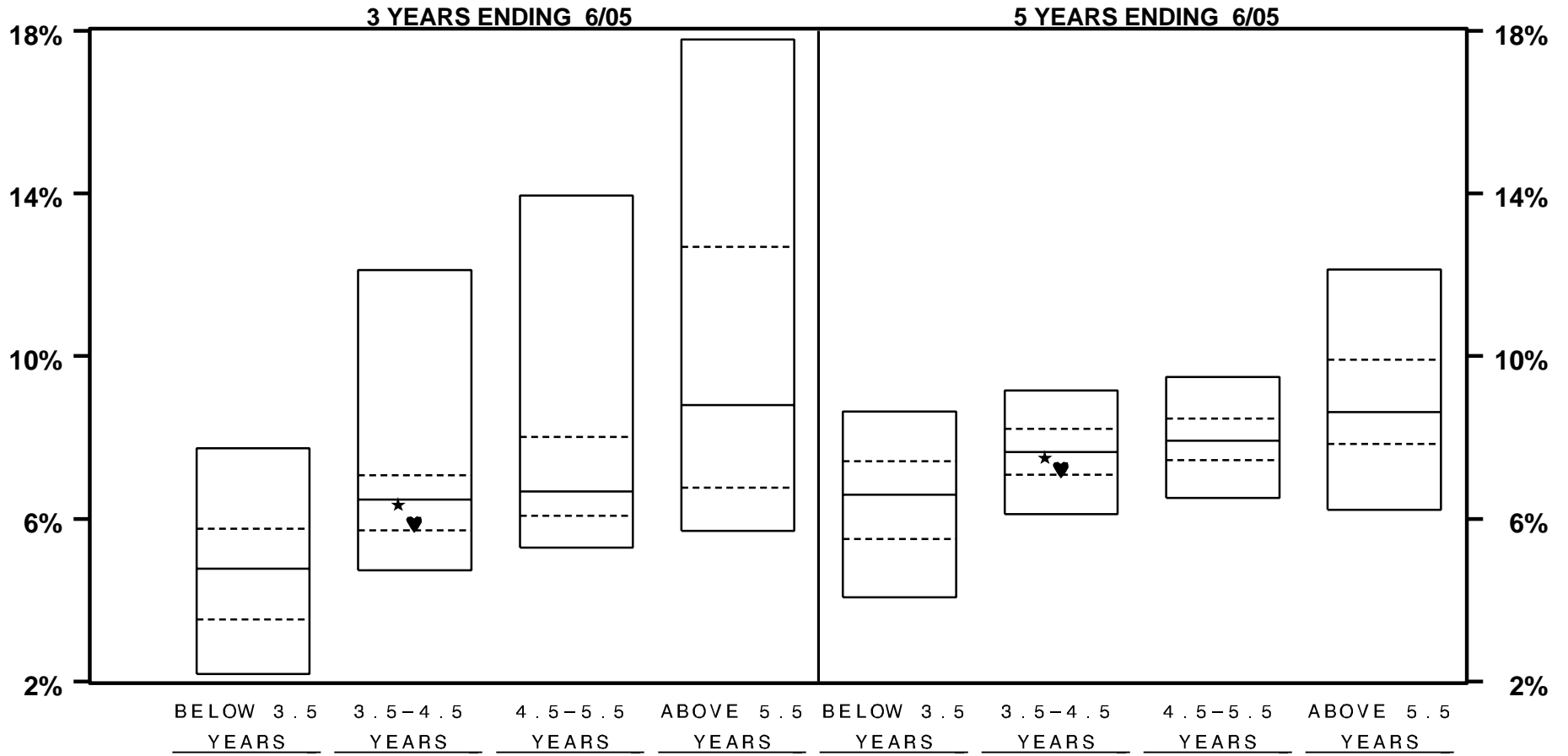

	BELOW 3.5 YEARS	3.5-4.5 YEARS	4.5-5.5 YEARS	ABOVE 5.5 YEARS	BELOW 3.5 YEARS	3.5-4.5 YEARS	4.5-5.5 YEARS	ABOVE 5.5 YEARS
★ MUNI COMPOSITE		6.4 54				7.5 55		
♥ SEIX CORE		5.9 68				7.2 70		
MEDIAN	4.8	6.5	6.7	8.8	6.6	7.6	7.9	8.6

VERMONT MUNICIPAL EMPLOYEES

BOND ONLY - RATES OF RETURN

COMPARED TO FUNDS WITH SIMILAR COUPON

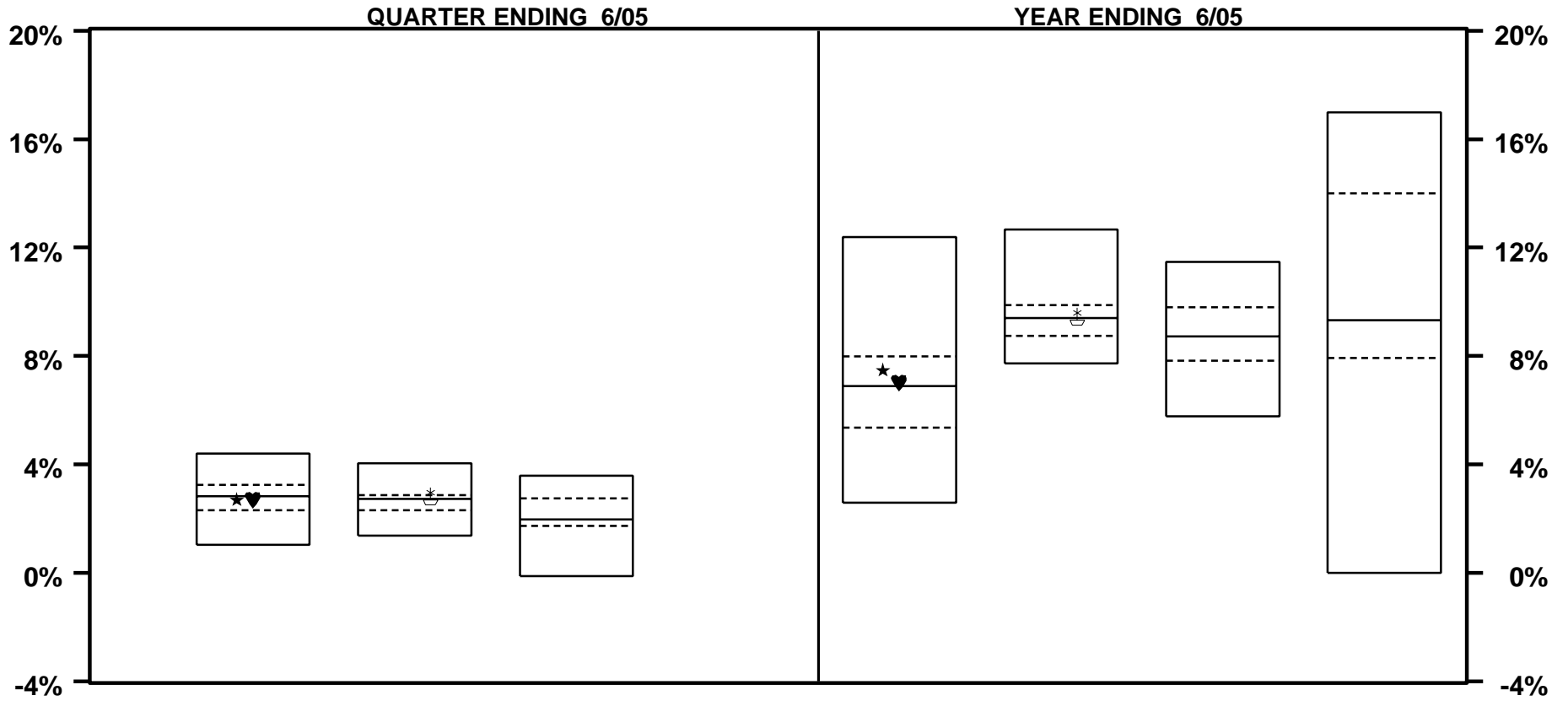

	QUARTER ENDING 6/05			YEAR ENDING 6/05			
	BELOW 8.0%	8.0-8.5%	8.5-9.0%	BELOW 8.0%	8.0-8.5%	8.5-9.0%	ABOVE 9.0%
★ MUNI COMPOSITE	2.7			7.5			
♥ SEIX CORE	2.7			7.0			
⊕ SEIX HIGH YIELD		2.8			9.5		
MEDIAN	2.8	2.7	2.0	6.9	9.4	8.7	9.3

VERMONT MUNICIPAL EMPLOYEES

BOND ONLY - RATES OF RETURN

COMPARED TO FUNDS WITH SIMILAR COUPON

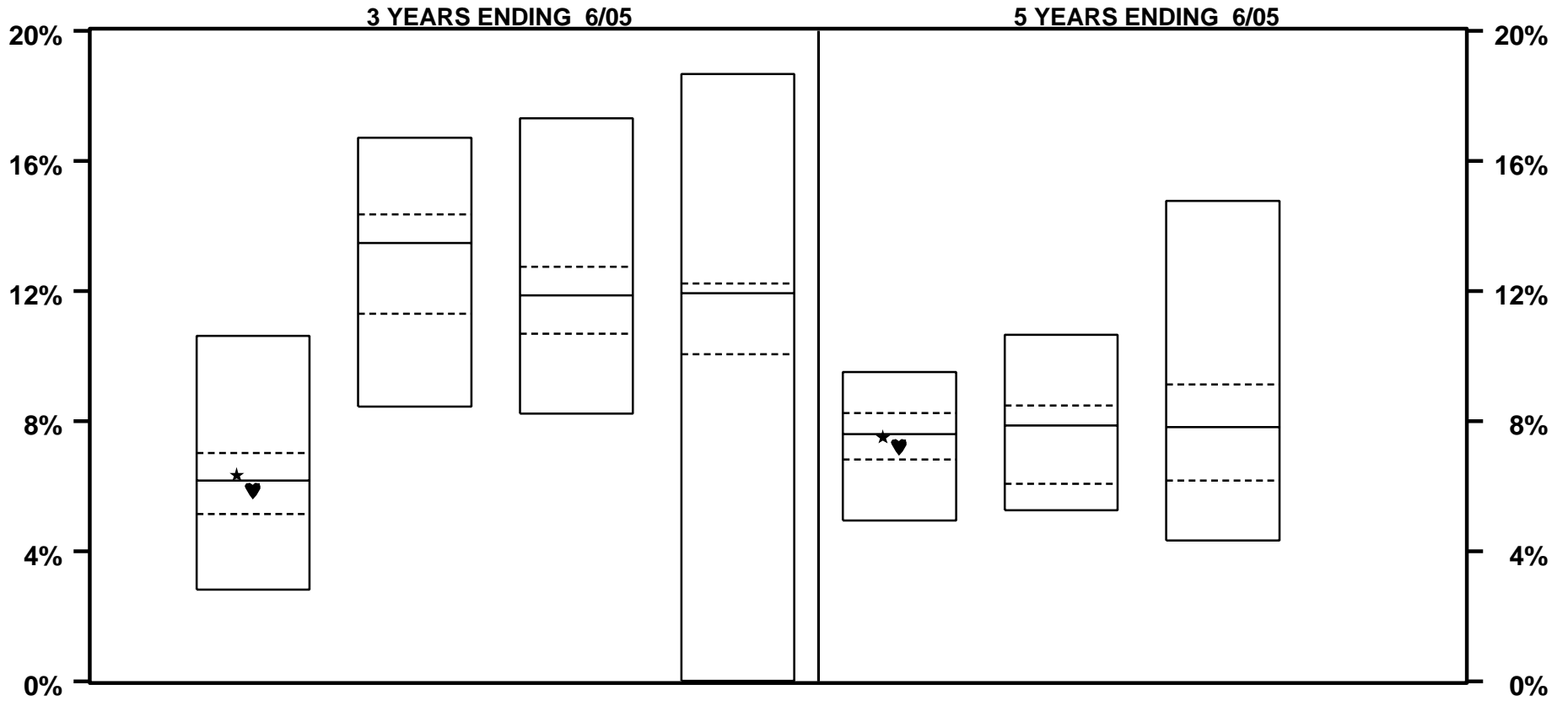

	3 YEARS ENDING 6/05				5 YEARS ENDING 6/05			
	BELOW	8.0-8.5%	8.5-9.0%	ABOVE	BELOW	8.0-8.5%	8.5-9.0%	ABOVE
	8.0%			9.0%	8.0%			9.0%
★ MUNI COMPOSITE	6.4				7.5			
♥ SEIX CORE	5.9				7.2			
MEDIAN	6.2	13.5	11.9	11.9	7.6	7.9	7.8	

VERMONT MUNICIPAL EMPLOYEES

FIXED INCOME MANAGER STYLE DEFINITIONS

SHORT

Short Term Fixed Income managers are generally retained as "cash" managers. They provide an alternative to SHORT TERM INVESTMENT VEHICLES and attempt to add value through superior management of high quality short term instruments. In order to be classified as Short Term, a managers portfolio duration should be 0-40% of the Lehman Brothers Aggregate's and an average quality rating of at least 6.3. Contractual restrictions limiting a short term fund's duration generally preclude the use of one of the major bond indices as a relevant benchmark. Instead, 90 day T-Bills are generally used as the portfolio's standard.

INTERMEDIATE

An Intermediate manager invests in high quality issues with a duration that is 40-80% of the Lehman Brothers Aggregate and an average quality rating of at least 6.3. Although many Intermediate managers are contractually prevented from extending a portfolio's maturity, other Intermediate managers assert that intermediate duration securities provide the best risk/reward trade-off relative to short and long duration instruments.

CORE

A Core manager differs from the above three styles in that he does not concentrate on achieving a superior return within a certain duration range. Instead, he prefers to emphasize sector or individual bond selection to create a portfolio whose duration is similar to the index's, but produces a superior return. A Core manager's defining criteria include a duration ranging from 80-120% of the Lehman Brothers Aggregate and an average quality rating of at least 6.3.

CORE PLUS

Core-plus fixed income management is a strategy of incorporating moderate allocations to nonbenchmark sectors in order to achieve excess return without taking on excessive additional risk. Core-plus portfolios typically include diversifying exposure to sovereign, high yield, and/or emerging market debt. Core-plus is an assigned style.

LONG

To be classified as a Long manager, an investment manager's portfolio must have a duration that is greater than 120% of the Lehman Brothers Aggregate's and an average quality rating of at least 6.3. Long managers believe that the increased return provided by the long end of the maturity spectrum compensates for the higher volatility of longer duration issues.

HIGH YIELD

A High Yield Manager invests in lower quality, higher yielding issues; generally companies in financial difficulty or with limited financing means. The debt issued by these types of companies carry higher rates to compensate for the increased credit risk. A High Yield manager emphasizes security selection to take advantage of the superior return produced by the debt of less credit-worthy companies. A High Yield manager's portfolio must have a current yield to maturity that is at least 120% of the Lehman Brothers Aggregate's and an average quality rating less than or equal to 6.3.

VERMONT MUNICIPAL EMPLOYEES

FIXED INCOME MANAGER STYLE ANALYSIS - TOTAL RETURNS

QUARTER ENDING 6/05

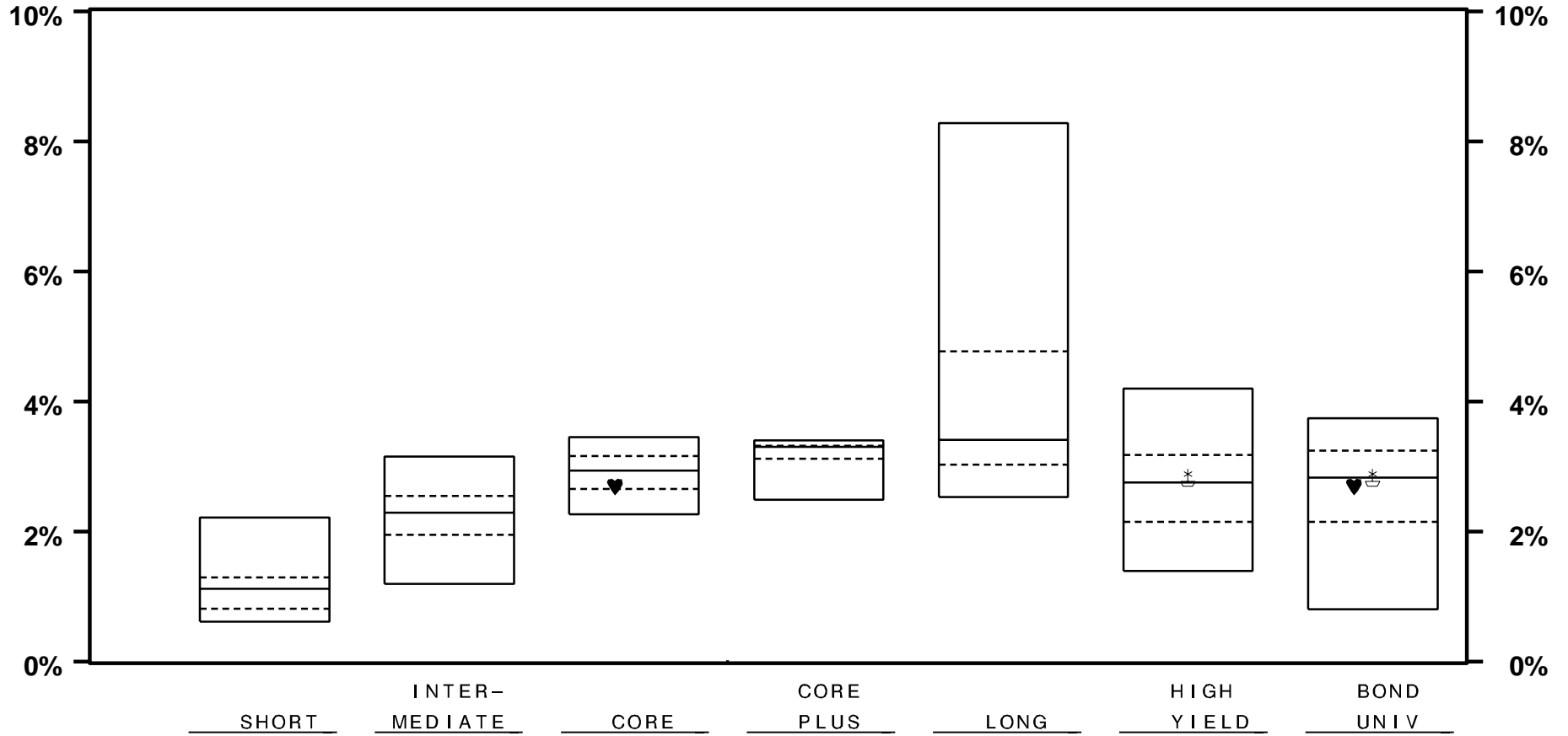

♥ SEIX CORE
 ✚ SEIX HIGH YIELD

MEDIAN	1.1	2.3	2.9	3.3	3.4	2.8	2.8
			2.7 72			2.8 41	2.7 55 2.8 50

VERMONT MUNICIPAL EMPLOYEES

FIXED INCOME MANAGER STYLE ANALYSIS - TOTAL RETURNS

YEAR ENDING 6/05

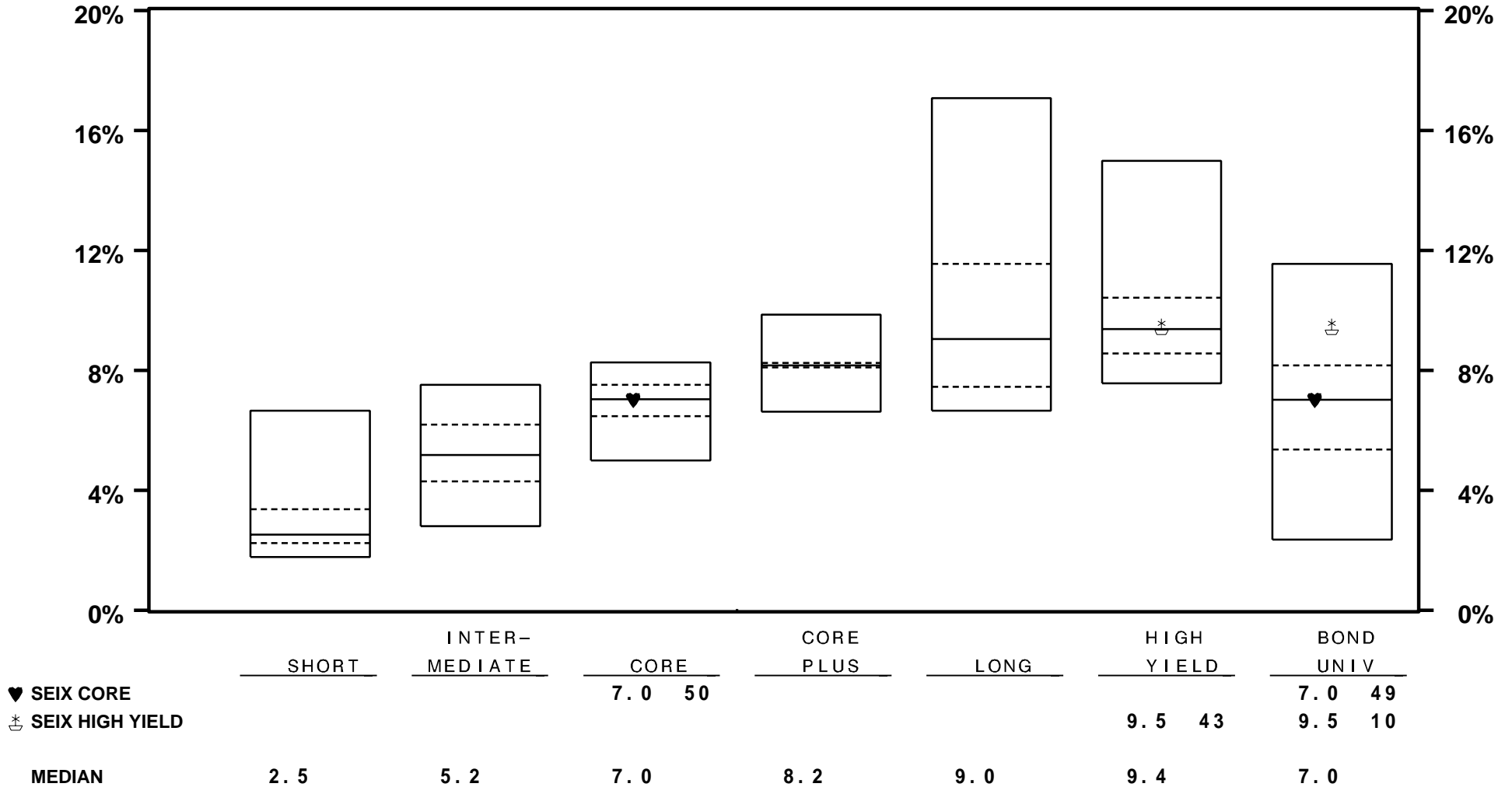

VERMONT MUNICIPAL EMPLOYEES

FIXED INCOME MANAGER STYLE ANALYSIS - TOTAL RETURNS

TWO YEARS ENDING 6/05

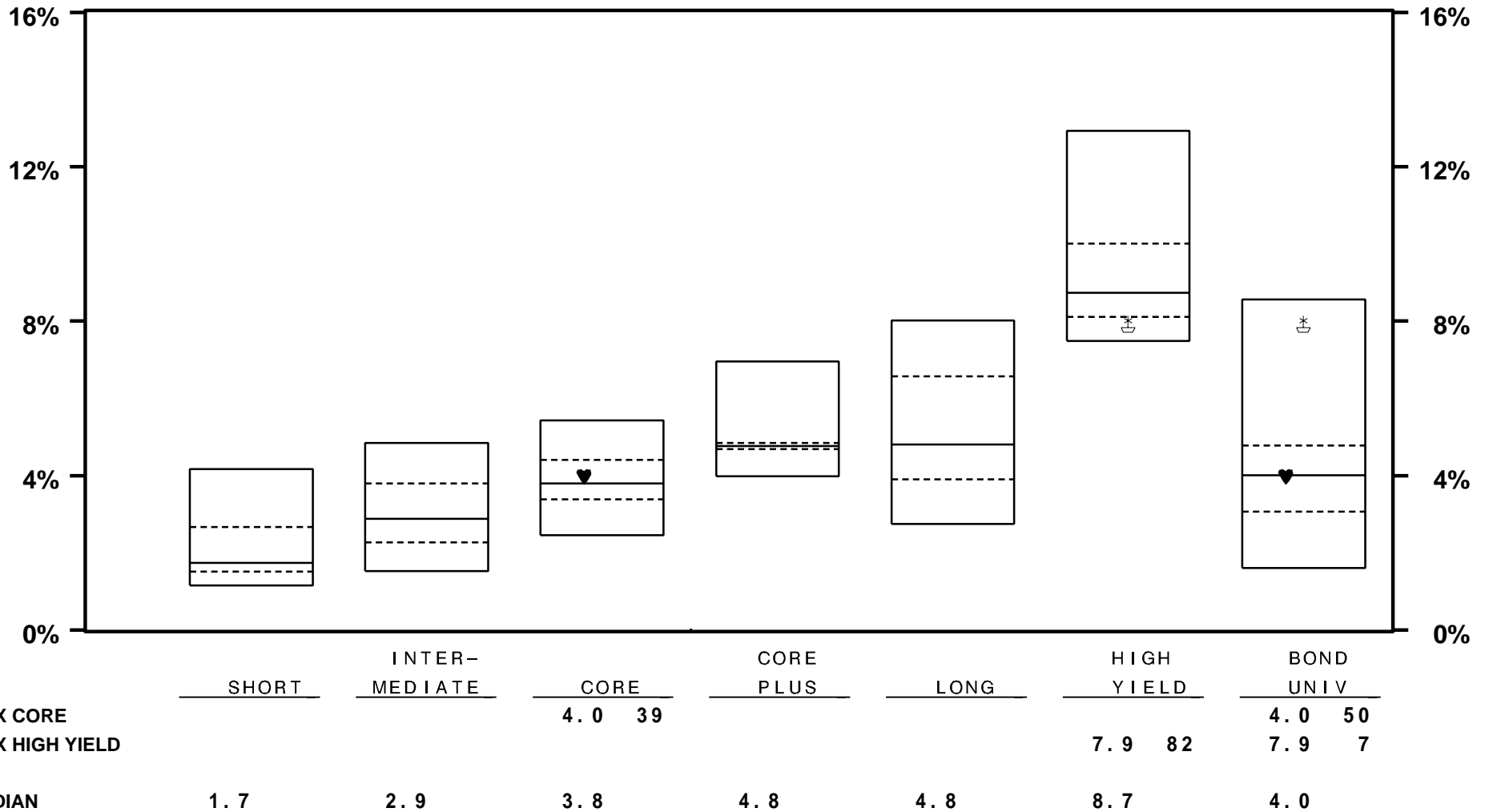

VERMONT MUNICIPAL EMPLOYEES

FIXED INCOME MANAGER STYLE ANALYSIS - TOTAL RETURNS

THREE YEARS ENDING 6/05

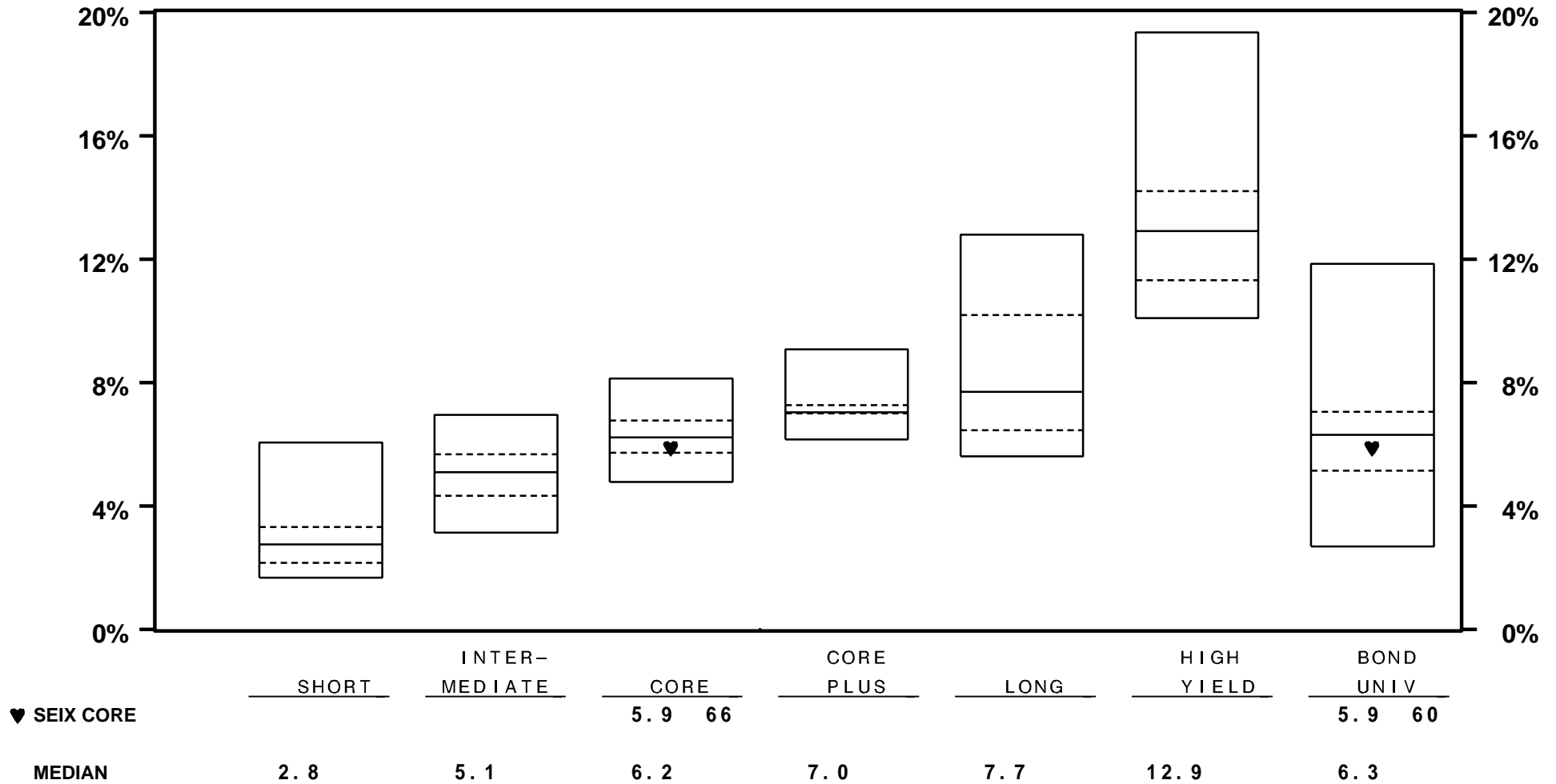

VERMONT MUNICIPAL EMPLOYEES

FIXED INCOME MANAGER STYLE ANALYSIS - TOTAL RETURNS

FOUR YEARS ENDING 6/05

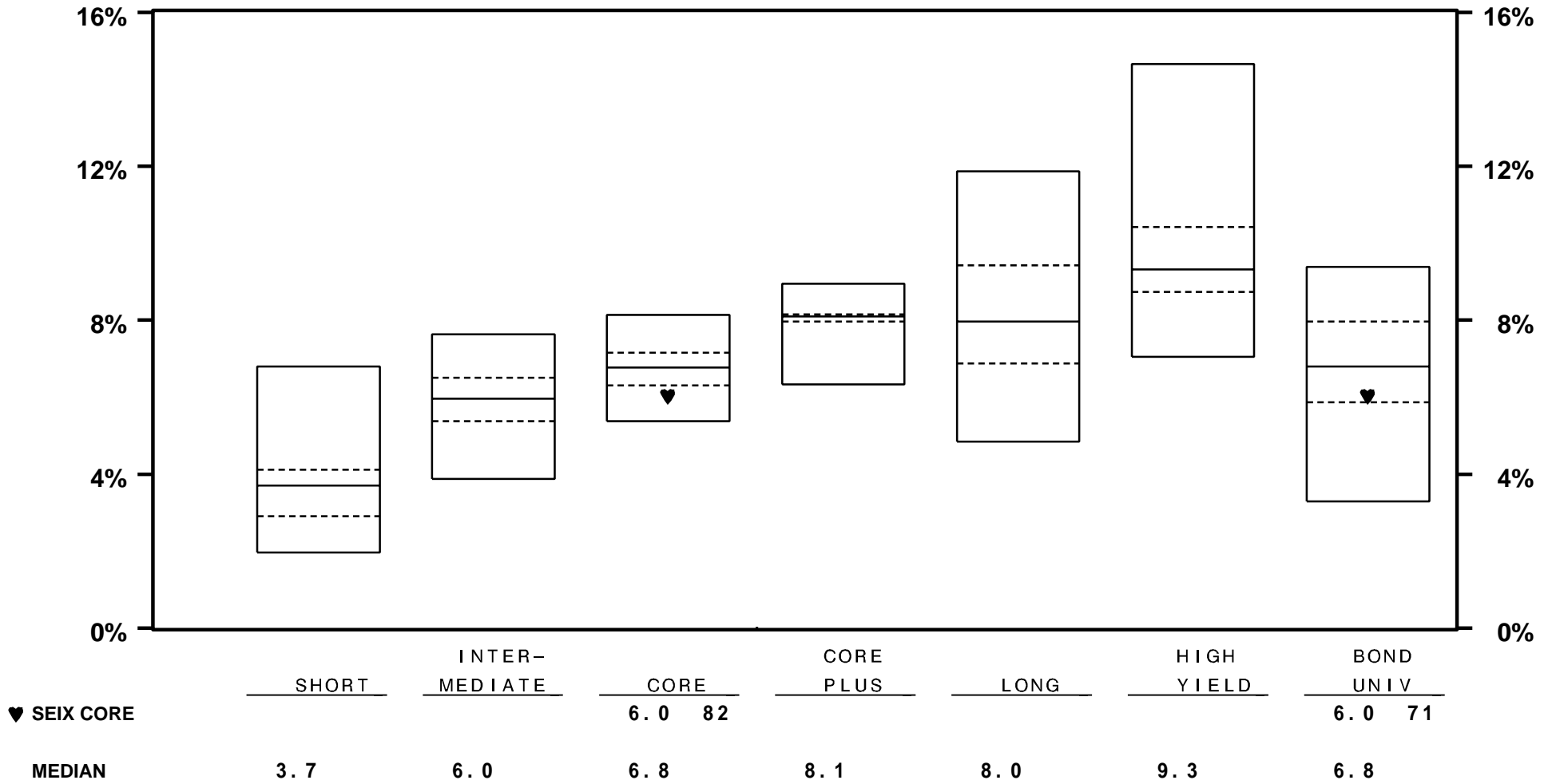

VERMONT MUNICIPAL EMPLOYEES

FIXED INCOME MANAGER STYLE ANALYSIS - TOTAL RETURNS

FIVE YEARS ENDING 6/05

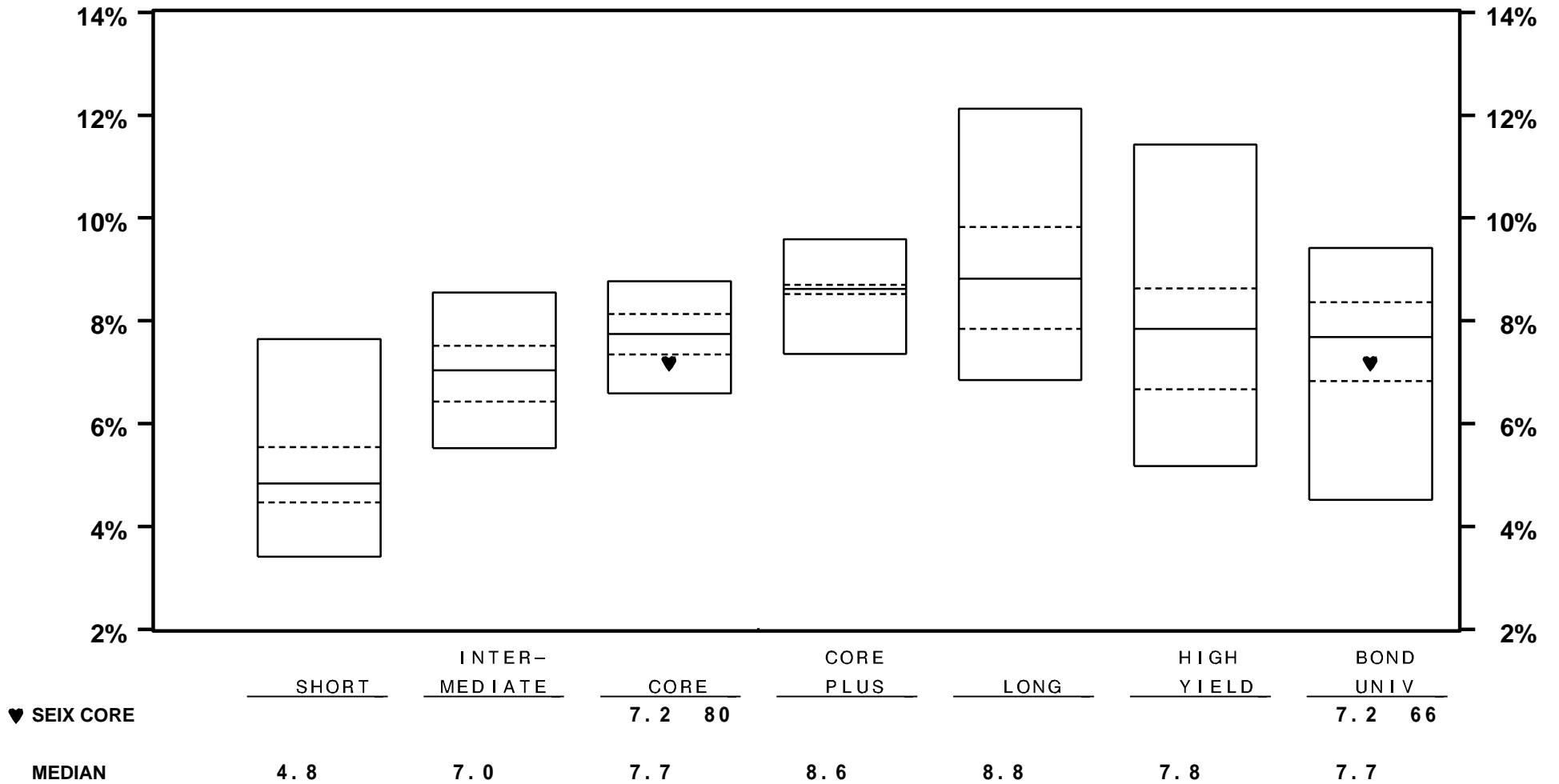

VERMONT MUNICIPAL EMPLOYEES

FIXED INCOME MANAGER STYLE ANALYSIS - BOND ONLY RETURNS

QUARTER ENDING 6/05

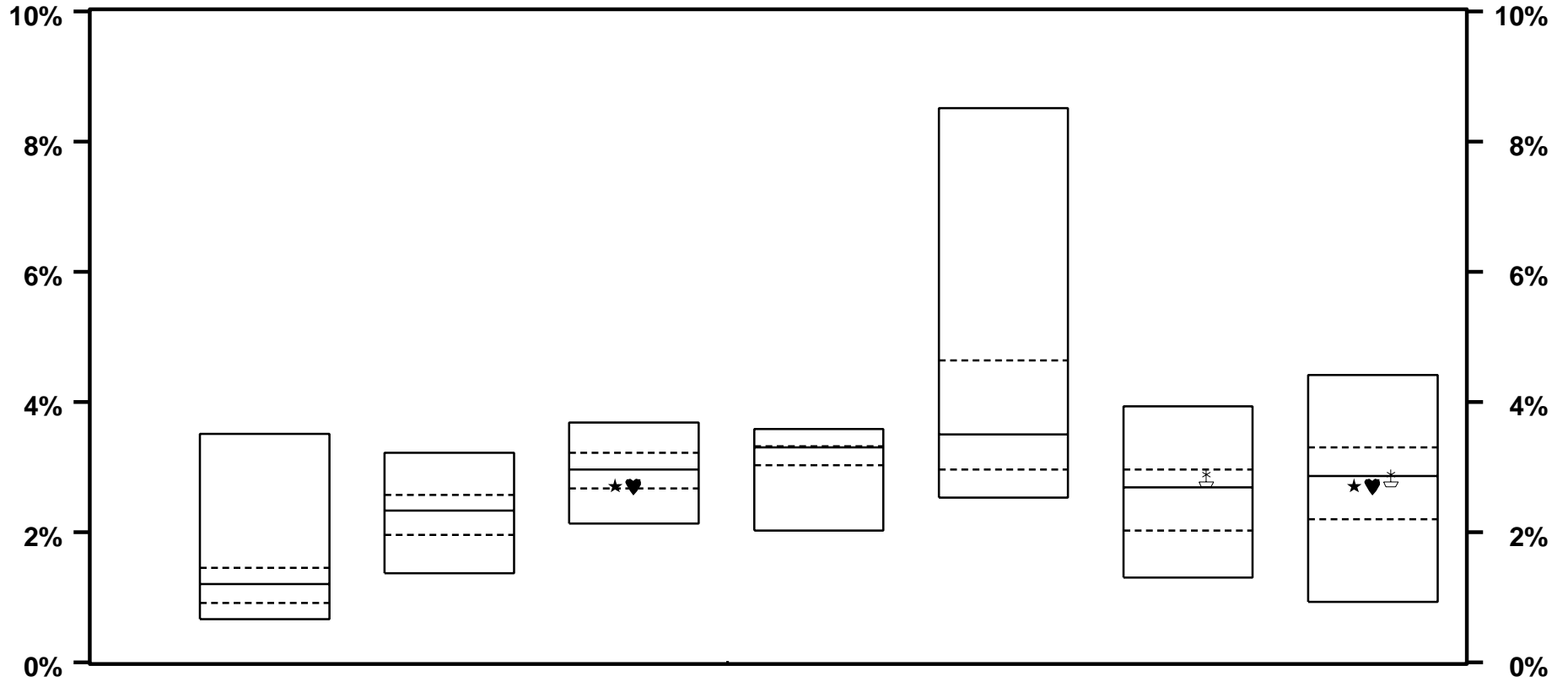

★ MUNI COMPOSITE
 ♥ SEIX CORE
 ⚖ SEIX HIGH YIELD

Style	Median	SEIX	Count
CORE	2.7	70	
CORE PLUS	2.7	71	
HIGH YIELD	2.8	34	
BOND UNIV	2.7	55	
BOND UNIV	2.7	55	
BOND UNIV	2.8	50	

Style	Median
SHORT	1.2
INTER-MEDIATE	2.3
CORE	3.0
CORE PLUS	3.3
LONG	3.5
HIGH YIELD	2.7
BOND UNIV	2.9

VERMONT MUNICIPAL EMPLOYEES

FIXED INCOME MANAGER STYLE ANALYSIS - BOND ONLY RETURNS

YEAR ENDING 6/05

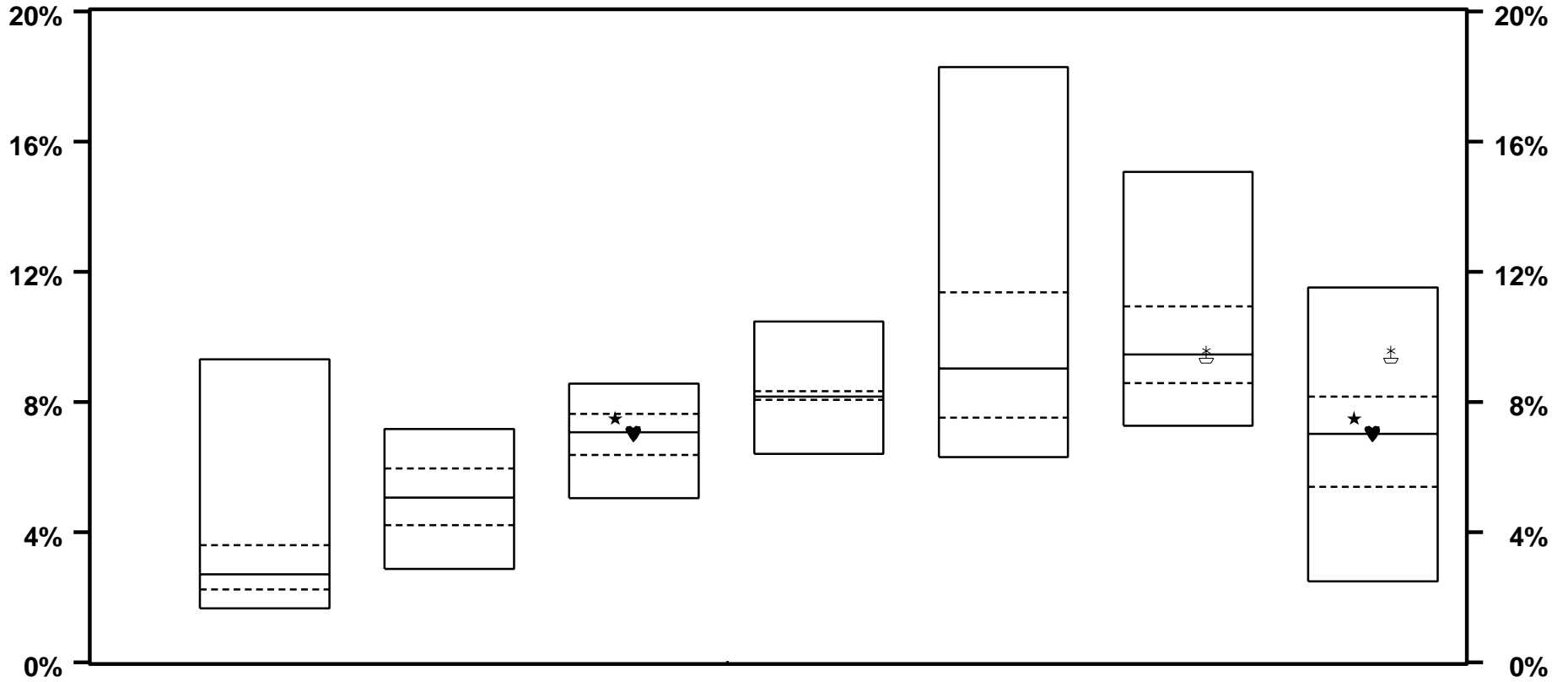

	SHORT	INTER-MEDIATE	CORE	CORE PLUS	LONG	HIGH YIELD	BOND UNIV
★ MUNI COMPOSITE			7.5 30				7.5 40
♥ SEIX CORE			7.0 53				7.0 49
⊕ SEIX HIGH YIELD						9.5 49	9.5 11
MEDIAN	2.7	5.1	7.1	8.2	9.0	9.5	7.0

VERMONT MUNICIPAL EMPLOYEES

FIXED INCOME MANAGER STYLE ANALYSIS - BOND ONLY RETURNS

TWO YEARS ENDING 6/05

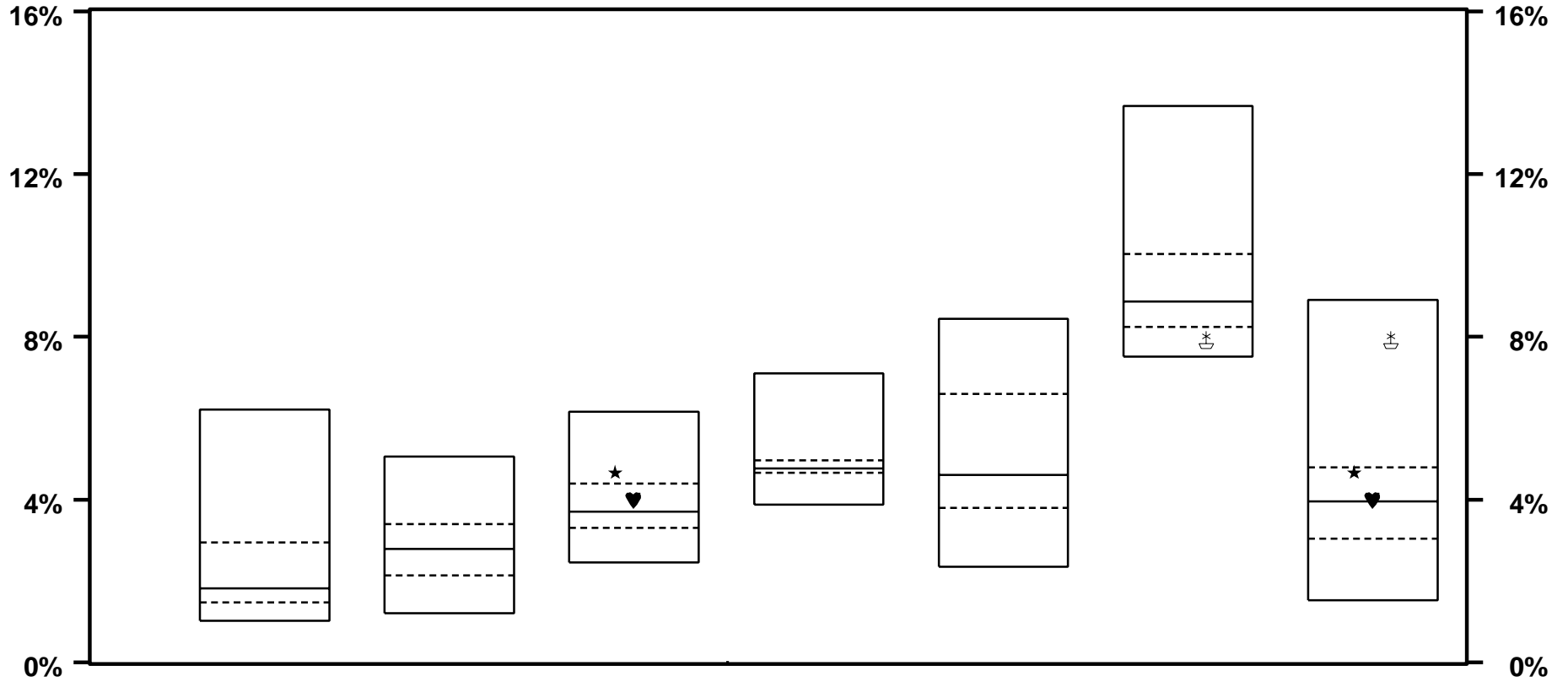

	SHORT	INTER-MEDIATE	CORE	CORE PLUS	LONG	HIGH YIELD	BOND UNIV
★ MUNI COMPOSITE			4.7 19				4.7 34
♥ SEIX CORE			4.0 38				4.0 49
⊕ SEIX HIGH YIELD						7.9 86	7.9 8
MEDIAN	1.8	2.8	3.7	4.8	4.6	8.9	4.0

VERMONT MUNICIPAL EMPLOYEES

FIXED INCOME MANAGER STYLE ANALYSIS - BOND ONLY RETURNS

THREE YEARS ENDING 6/05

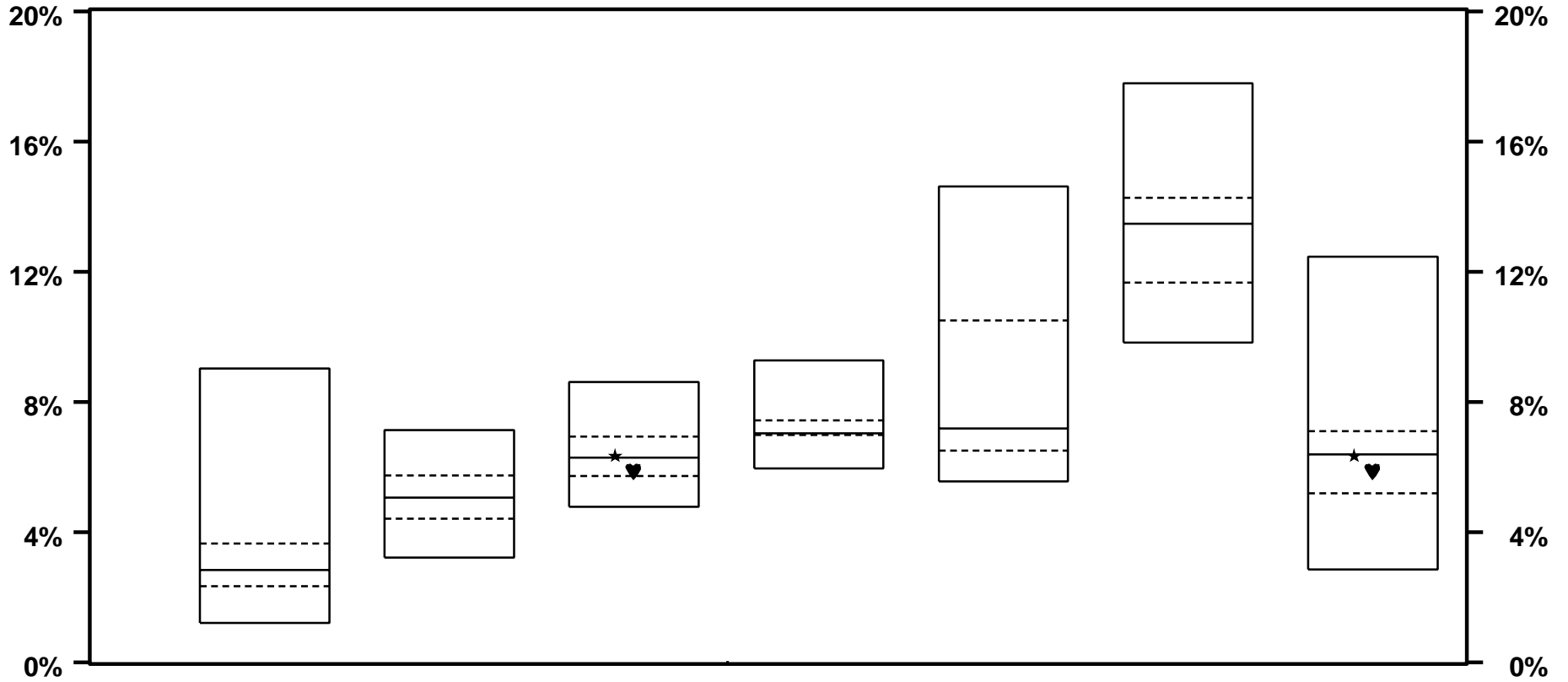

	SHORT	INTER-MEDIATE	CORE	CORE PLUS	LONG	HIGH YIELD	BOND UNIV
★ MUNI COMPOSITE			6.4				6.4
♥ SEIX CORE			5.9				5.9
MEDIAN	2.8	5.1	6.3	7.0	7.2	13.5	6.4

VERMONT MUNICIPAL EMPLOYEES

FIXED INCOME MANAGER STYLE ANALYSIS - BOND ONLY RETURNS

FOUR YEARS ENDING 6/05

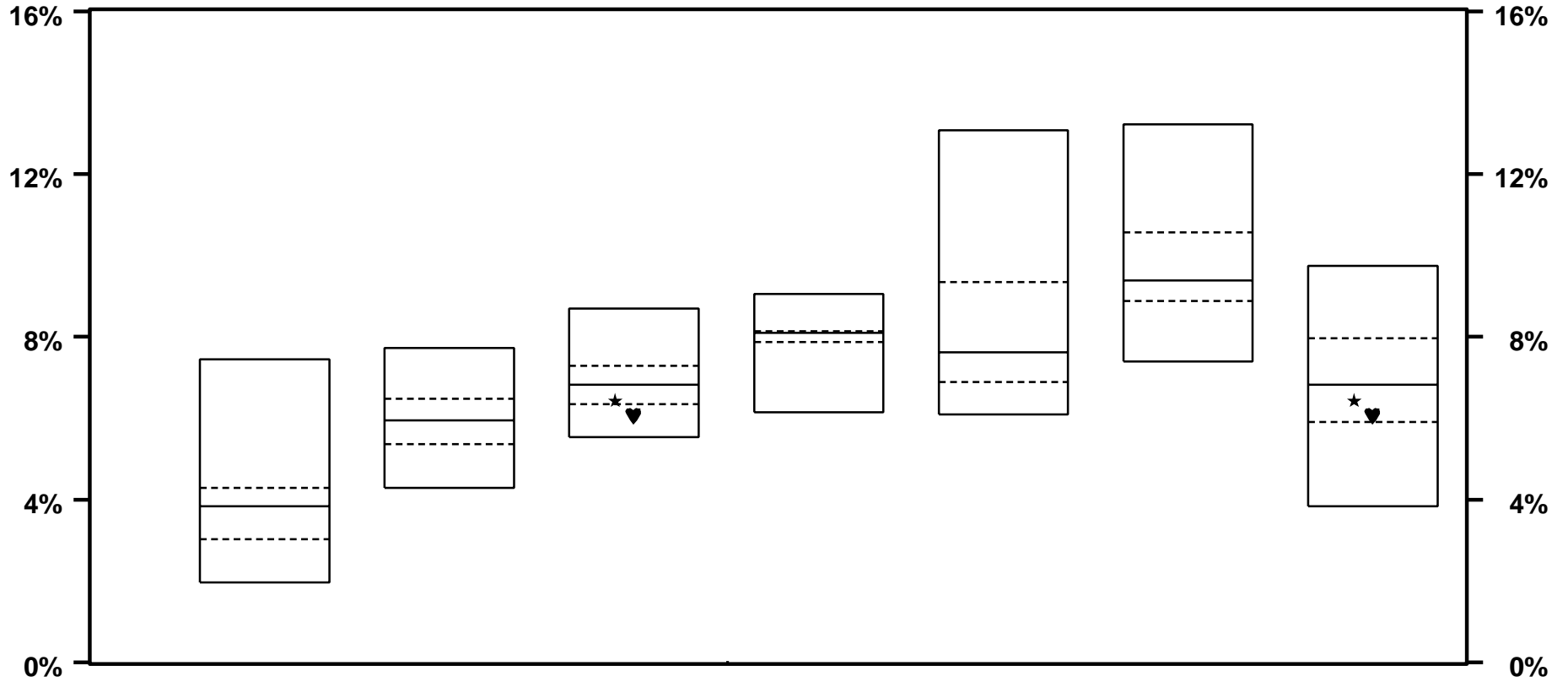

	SHORT	INTER-MEDIATE	CORE	CORE PLUS	LONG	HIGH YIELD	BOND UNIV
★ MUNI COMPOSITE			6.4				6.4
♥ SEIX CORE			6.1				6.1
MEDIAN	3.8	5.9	6.8	8.1	7.6	9.4	6.8

VERMONT MUNICIPAL EMPLOYEES

FIXED INCOME MANAGER STYLE ANALYSIS - BOND ONLY RETURNS

FIVE YEARS ENDING 6/05

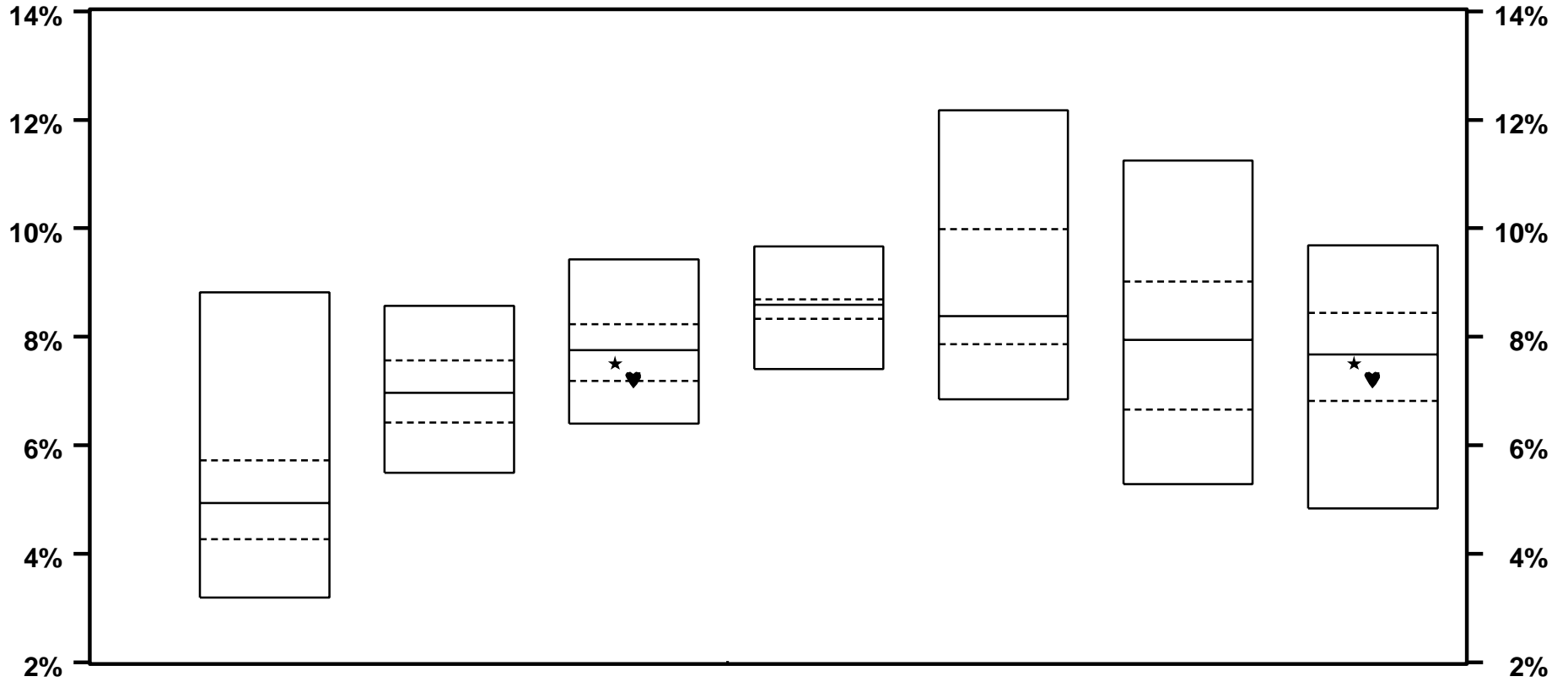

	SHORT	INTER-MEDIATE	CORE	CORE PLUS	LONG	HIGH YIELD	BOND UNIV
★ MUNI COMPOSITE			7.5 63				7.5 54
♥ SEIX CORE			7.2 74				7.2 64
MEDIAN	4.9	7.0	7.8	8.6	8.4	7.9	7.7

VERMONT MUNICIPAL EMPLOYEES

SOURCES OF PORTFOLIO GROWTH (\$000)

MUNICIPAL SYSTEM COMPOSITE

PERIOD ENDING	BEGINNING MARKET VALUE	NET CONTRIB	INCOME RECEIVED	GAIN (LOSS)	ENDING MARKET VALUE	TOTAL RETURN
9/00	171,940	-4,637	0	937	168,240	0.5
12/00	168,240	366	0	2,035	170,641	1.2
3/01	170,641	-25	0	-7,468	163,148	-4.4
6/01	163,148	3,226	837	4,904	172,115	3.5
9/01	172,115	472	848	-10,618	162,817	-5.7
12/01	162,817	243	513	9,484	173,055	6.1
3/02	173,055	1,135	490	2,296	176,977	1.6
6/02	176,977	857	761	-6,878	171,715	-3.5
9/02	171,715	994	1,201	-17,722	156,188	-9.7
12/02	156,188	2,089	759	6,029	165,064	4.3
3/03	165,064	5,941	868	-4,721	167,152	-2.3
6/03	167,152	270	799	17,100	185,321	10.7
9/03	185,321	664	891	5,261	192,137	3.3
12/03	192,137	2,358	970	14,746	210,212	8.1
3/04	210,212	2,901	831	4,250	218,194	2.4
6/04	218,194	1,635	694	203	220,726	0.4
9/04	220,726	1,004	1,139	-1,129	221,740	0.0
12/04	221,740	2,177	5,478	10,352	239,747	7.1
3/05	239,747	2,393	837	-4,163	238,815	-1.4
6/05	238,815	1,153	484	5,286	245,739	2.4

VERMONT MUNICIPAL EMPLOYEES

SOURCES OF PORTFOLIO GROWTH (\$000)

DOMESTIC EQUITY COMPOSITE

PERIOD ENDING	BEGINNING MARKET VALUE	NET CONTRIB	INCOME RECEIVED	GAIN (LOSS)	ENDING MARKET VALUE	TOTAL RETURN
9/00	73,237	0	0	698	73,935	1.0
12/00	73,935	1	0	-1,513	72,423	-2.1
3/01	72,423	0	0	-6,591	65,832	-9.1
6/01	65,832	-33	155	4,286	70,241	6.7
9/01	70,241	-30	172	-8,997	61,386	-12.6
12/01	61,386	14	143	8,272	69,816	13.7
3/02	69,816	-33	142	1,528	71,452	2.4
6/02	71,452	1,965	150	-7,660	65,908	-10.4
9/02	65,908	6,721	668	-11,998	61,299	-17.6
12/02	61,299	219	168	2,827	64,514	4.9
3/03	64,514	9,969	176	-2,633	72,027	-3.6
6/03	72,027	1,993	191	11,543	85,754	16.1
9/03	85,754	-40	207	3,577	89,499	4.4
12/03	89,499	-5,041	210	9,788	94,456	11.8
3/04	94,456	-44	219	2,102	96,733	2.5
6/04	96,733	957	147	1,704	99,540	1.9
9/04	99,540	-43	277	-3,479	96,296	-3.2
12/04	96,296	1,954	4,337	5,179	107,767	9.7
3/05	107,767	-2,049	229	-3,735	102,212	-3.3
6/05	102,212	1,957	231	3,183	107,582	3.3

VERMONT MUNICIPAL EMPLOYEES

SOURCES OF PORTFOLIO GROWTH (\$000)

DELAWARE

PERIOD ENDING	BEGINNING MARKET VALUE	NET CONTRIB	INCOME RECEIVED	GAIN (LOSS)	ENDING MARKET VALUE	TOTAL RETURN
9/00	24,252	0	0	2,102	26,354	8.7
12/00	26,354	0	0	2,630	28,984	10.0
3/01	28,984	0	0	-1,141	27,843	-3.9
6/01	27,843	0	155	926	28,925	3.9
9/01	28,925	0	160	-3,452	25,632	-11.4
12/01	25,632	49	143	2,049	27,874	8.6
3/02	27,874	0	142	1,406	29,422	5.5
6/02	29,422	0	149	-2,363	27,208	-7.5
9/02	27,208	0	152	-5,222	22,137	-18.6
12/02	22,137	0	161	1,611	23,909	8.0
3/03	23,909	4,500	176	-1,650	26,935	-5.4
6/03	26,935	1,527	191	4,819	33,472	18.2
9/03	33,472	1	207	648	34,329	2.6
12/03	34,329	-1,000	210	4,121	37,660	12.9
3/04	37,660	0	219	450	38,329	1.8
6/04	38,329	0	147	585	39,060	1.9
9/04	39,060	0	213	-672	38,601	-1.2
12/04	38,601	0	207	3,167	41,975	8.7
3/05	41,975	0	229	-766	41,437	-1.3
6/05	41,437	0	231	312	41,980	1.3

VERMONT MUNICIPAL EMPLOYEES

SOURCES OF PORTFOLIO GROWTH (\$000)

ALLIANCE LARGE CAP GROWTH FUND

PERIOD ENDING	BEGINNING MARKET VALUE	NET CONTRIB	INCOME RECEIVED	GAIN (LOSS)	ENDING MARKET VALUE	TOTAL RETURN
9/00	35,650	0	0	-2,072	33,578	-5.8
12/00	33,578	0	0	-4,985	28,593	-14.9
3/01	28,593	0	0	-4,990	23,603	-17.4
6/01	23,603	0	0	1,479	25,082	6.3
9/01	25,082	0	0	-3,889	21,193	-15.5
12/01	21,193	0	0	3,222	24,415	15.2
3/02	24,415	0	0	-1,130	23,285	-4.6
6/02	23,285	2,000	1	-3,597	21,689	-14.9
9/02	21,689	4,750	9	-2,949	23,499	-15.0
12/02	23,499	250	6	413	24,168	1.8
3/03	24,168	4,500	0	-181	28,487	-1.1
6/03	28,487	0	0	3,620	32,107	12.7
9/03	32,107	0	0	1,262	33,369	3.9
12/03	33,369	-2,000	0	2,753	34,121	8.8
3/04	34,121	0	0	549	34,671	1.6
6/04	34,671	1,000	0	639	36,310	1.8
9/04	36,310	0	0	-2,084	34,225	-5.7
12/04	34,225	2,000	0	3,343	39,569	9.2
3/05	39,569	0	0	-2,453	37,116	-6.2
6/05	37,116	0	0	2,389	39,505	6.4

VERMONT MUNICIPAL EMPLOYEES

SOURCES OF PORTFOLIO GROWTH (\$000)

LAZARD SMALL CAP FUND

PERIOD ENDING	BEGINNING MARKET VALUE	NET CONTRIB	INCOME RECEIVED	GAIN (LOSS)	ENDING MARKET VALUE	TOTAL RETURN
9/00	13,335	0	0	668	14,003	5.0
12/00	14,003	0	0	843	14,846	6.0
3/01	14,846	0	0	-460	14,386	-2.9
6/01	14,386	-33	0	1,882	16,234	13.1
9/01	16,234	-30	13	-1,656	14,562	-10.1
12/01	14,562	-36	0	3,001	17,527	20.6
3/02	17,527	-33	0	1,252	18,746	7.2
6/02	18,746	-35	0	-1,699	17,012	-9.1
9/02	17,012	1,971	507	-3,827	15,664	-19.3
12/02	15,664	-31	0	804	16,437	5.1
3/03	16,437	969	0	-801	16,605	-4.9
6/03	16,605	466	0	3,103	20,174	18.4
9/03	20,174	-40	0	1,667	21,801	8.3
12/03	21,801	-2,041	0	2,914	22,675	14.7
3/04	22,675	-44	0	1,103	23,733	4.9
6/04	23,733	-43	0	480	24,171	1.7
9/04	24,171	-44	65	-722	23,469	-2.7
12/04	23,469	-46	4,130	-1,331	26,223	11.9
3/05	26,223	-2,049	0	-516	23,659	-1.8
6/05	23,659	1,957	0	482	26,098	2.0

VERMONT MUNICIPAL EMPLOYEES

SOURCES OF PORTFOLIO GROWTH (\$000)

BRINSON - UBS

PERIOD ENDING	BEGINNING MARKET VALUE	NET CONTRIB	INCOME RECEIVED	GAIN (LOSS)	ENDING MARKET VALUE	TOTAL RETURN
9/ 00	26, 395	- 25	0	- 1, 922	24, 448	- 7. 3
12/ 00	24, 448	0	0	469	24, 917	1. 9
3/ 01	24, 917	9, 000	0	- 2, 923	30, 994	- 11. 7
6/ 01	30, 994	- 12	4	638	31, 624	2. 1
9/ 01	31, 624	0	0	- 3, 480	28, 143	- 11. 0
12/ 01	28, 143	0	0	2, 158	30, 301	7. 7
3/ 02	30, 301	0	0	1, 006	31, 307	3. 3
6/ 02	31, 307	2, 000	0	- 145	33, 163	- 0. 3
9/ 02	33, 163	3, 000	0	- 6, 800	29, 363	- 20. 3
12/ 02	29, 363	0	1	2, 620	31, 984	8. 9
3/ 03	31, 984	- 6, 000	0	- 2, 502	23, 482	- 8. 1
6/ 03	23, 482	495	0	4, 288	28, 265	18. 2
9/ 03	28, 265	0	0	1, 955	30, 220	6. 9
12/ 03	30, 220	0	0	4, 931	35, 152	16. 3
3/ 04	35, 152	0	0	985	36, 136	2. 8
6/ 04	36, 136	- 6	0	- 58	36, 073	- 0. 2
9/ 04	36, 073	0	0	566	36, 639	1. 6
12/ 04	36, 639	0	0	5, 249	41, 888	14. 3
3/ 05	41, 888	- 2, 000	- 4	- 161	39, 723	- 0. 4
6/ 05	39, 723	0	0	- 375	39, 348	- 1. 0

VERMONT MUNICIPAL EMPLOYEES

SOURCES OF PORTFOLIO GROWTH (\$000)

MET LIFE / SSR TOWER FUND

PERIOD ENDING	BEGINNING MARKET VALUE	NET CONTRIB	INCOME RECEIVED	GAIN (LOSS)	ENDING MARKET VALUE	TOTAL RETURN
9/ 00	11, 355	0	0	317	11, 672	2. 8
12/ 00	11, 672	0	0	509	12, 181	4. 4
3/ 01	12, 181	0	0	222	12, 403	1. 8
6/ 01	12, 403	- 2	0	228	12, 628	1. 8
9/ 01	12, 628	0	0	70	12, 698	0. 6
12/ 01	12, 698	- 38	0	79	12, 740	0. 6
3/ 02	12, 740	- 38	0	4	12, 705	0. 0
6/ 02	12, 705	- 38	262	- 147	12, 782	0. 9
9/ 02	12, 782	- 37	242	- 189	12, 799	0. 4
12/ 02	12, 799	18	218	- 146	12, 889	0. 6
3/ 03	12, 889	- 31	226	2	13, 086	1. 8
6/ 03	13, 086	- 33	232	48	13, 334	2. 1
9/ 03	13, 334	- 34	0	321	13, 621	2. 4
12/ 03	13, 621	- 35	219	- 144	13, 660	0. 6
3/ 04	13, 660	- 34	0	140	13, 767	1. 0
6/ 04	13, 767	- 35	0	393	14, 125	2. 9
9/ 04	14, 125	- 42	0	22	14, 106	0. 2
12/ 04	14, 106	- 42	0	340	14, 404	2. 4
3/ 05	14, 404	1, 958	0	641	17, 003	4. 4
6/ 05	17, 003	- 49	0	713	17, 668	4. 2

VERMONT MUNICIPAL EMPLOYEES

SOURCES OF PORTFOLIO GROWTH (\$000)

SEIX CORE

PERIOD ENDING	BEGINNING MARKET VALUE	NET CONTRIB	INCOME RECEIVED	GAIN (LOSS)	ENDING MARKET VALUE	TOTAL RETURN
9/00	53,366	-1	0	1,741	55,106	3.3
12/00	55,106	-1	0	2,505	57,610	4.5
3/01	57,610	-7,003	0	1,730	52,337	3.0
6/01	52,337	44	598	-256	52,723	0.6
9/01	52,723	1	631	1,780	55,136	4.6
12/01	55,136	-1	352	-1,025	54,463	-1.2
3/02	54,463	0	307	-230	54,540	0.1
6/02	54,540	0	331	1,279	56,150	3.0
9/02	56,150	-8,000	259	1,238	49,647	2.7
12/02	49,647	0	364	729	50,740	2.2
3/03	50,740	3,000	436	464	54,640	1.7
6/03	54,640	-8,500	374	1,220	47,733	2.9
9/03	47,733	0	635	-645	47,723	0.0
12/03	47,723	4,000	333	-90	51,967	0.5
3/04	51,967	0	433	942	53,342	2.6
6/04	53,342	6,000	314	-1,441	58,214	-2.0
9/04	58,214	1,500	648	1,434	61,797	3.5
12/04	61,797	500	323	223	62,842	0.9
3/05	62,842	3,000	413	-557	65,698	-0.3
6/05	65,698	0	547	1,226	67,472	2.7

VERMONT MUNICIPAL EMPLOYEES

SOURCES OF PORTFOLIO GROWTH (\$000)

SEIX HIGH YIELD

PERIOD ENDING	BEGINNING MARKET VALUE	NET CONTRIB	INCOME RECEIVED	GAIN (LOSS)	ENDING MARKET VALUE	TOTAL RETURN
9/00						
12/00						
3/01						
6/01						
9/01						
12/01						
3/02						
6/02						
9/02						
12/02						
3/03						
6/03		9,000		55	9,055	
9/03	9,055	-12	48	46	9,137	1.1
12/03	9,137	986	191	263	10,579	4.5
3/04	10,579	-15	169	71	10,804	2.3
6/04	10,804	-15	163	-321	10,632	-1.5
9/04	10,632	-15	181	347	11,145	5.0
12/04	11,145	-16	306	25	11,461	3.0
3/05	11,461	984	179	-356	12,269	-1.5
6/05	12,269	-17	193	153	12,598	2.8

VERMONT MUNICIPAL EMPLOYEES
SOURCES OF PORTFOLIO GROWTH (\$000)

ALTERNATIVE INVESTMENTS

PERIOD ENDING	BEGINNING MARKET VALUE	NET CONTRIB	INCOME RECEIVED	GAIN (LOSS)	ENDING MARKET VALUE	TOTAL RETURN
9/ 00	1, 036	0	0	0	1, 036	0. 0
12/ 00	1, 036	0	0	1	1, 037	0. 0
3/ 01	1, 037	0	0	19	1, 056	1. 9
6/ 01	1, 056	0	60	0	1, 117	5. 7
9/ 01	1, 117	0	1	0	1, 117	0. 1
12/ 01	1, 117	0	1	0	1, 118	0. 0
3/ 02	1, 118	0	0	0	1, 118	0. 0
6/ 02	1, 118	0	0	- 232	887	- 20. 7
9/ 02	887	0	0	0	887	0. 0
12/ 02	887	0	0	0	888	0. 0
3/ 03	888	0	0	0	888	0. 0
6/ 03	888	0	0	- 59	829	- 6. 6
9/ 03	829	0	0	0	830	0. 0
12/ 03	830	0	0	0	830	0. 0
3/ 04	830	0	0	0	830	0. 0
6/ 04	830	0	0	0	830	0. 0
9/ 04	830	0	0	0	831	0. 0
12/ 04	831	80	0	- 171	740	- 18. 7
3/ 05	740	0	1	0	741	0. 1
6/ 05	741	0	1	- 109	632	- 14. 6

VERMONT MUNICIPAL EMPLOYEES

SOURCES OF PORTFOLIO GROWTH (\$000)

VERMONT INVESTMENTS

PERIOD ENDING	BEGINNING MARKET VALUE	NET CONTRIB	INCOME RECEIVED	GAIN (LOSS)	ENDING MARKET VALUE	TOTAL RETURN
9/00	6,551	-4,611	0	104	2,044	1.9
12/00	2,044	366	0	63	2,473	2.1
3/01	2,473	-2,022	0	75	526	2.6
6/01	526	3,229	20	8	3,782	1.1
9/01	3,782	500	44	9	4,335	1.3
12/01	4,335	267	17	-1	4,619	0.4
3/02	4,619	1,206	41	-12	5,854	0.6
6/02	5,854	-3,071	17	25	2,825	0.9
9/02	2,825	-690	31	28	2,193	1.8
12/02	2,193	1,851	9	-2	4,050	0.1
3/03	4,050	-997	30	-54	3,030	-0.8
6/03	3,030	-2,685	1	5	351	0.6
9/03	351	750	0	7	1,108	1.3
12/03	1,108	2,447	16	-2	3,569	0.5
3/04	3,569	2,994	10	9	6,581	0.4
6/04	6,581	-5,267	71	-74	1,311	-0.3
9/04	1,311	-396	32	-20	926	0.8
12/04	926	-300	512	-494	645	1.1
3/05	645	500	20	5	1,170	1.8
6/05	1,170	-738	-488	494	438	0.5

VERMONT MUNICIPAL EMPLOYEES

PORTFOLIO ASSET GROWTH BY SEGMENT (\$000)

QUARTER ENDING 6/05

<u>PORTFOLIO</u>	<u>BEGINNING VALUE</u>	<u>NET CONTR</u>	<u>INCOME RECEIVED</u>	<u>GAIN (LOSS)</u>	<u>END VALUE</u>
MUNI COMPOSITE	238,815	1,153	484	5,286	245,739
COMMON STOCK	101,980	1,871	231	3,183	107,265
INT'L C/S	39,715	0	0	-375	39,340
BONDS	78,283	-17	741	1,375	80,382
CASH EQUIV	1,252	-652	-487	499	612
REAL ESTATE	17,003	-49	0	713	17,668
PRIVATE INVEST	582	0	0	-109	472
EQTY COMPOSITE	102,212	1,957	231	3,183	107,582
COMMON STOCK	101,980	1,871	231	3,183	107,265
CASH EQUIV	232	85	0	0	317
DELAWARE	41,437	0	231	312	41,980
COMMON STOCK	41,206	-85	231	312	41,663
CASH EQUIV	232	85	0	0	317
ALLIANCE	37,116	0	0	2,389	39,505
COMMON STOCK	37,116	0	0	2,389	39,505
LAZARD	23,659	1,957	0	482	26,098
COMMON STOCK	23,659	1,957	0	482	26,098

VERMONT MUNICIPAL EMPLOYEES

PORTFOLIO ASSET GROWTH BY SEGMENT (\$000)

QUARTER ENDING 6/05

<u>PORTFOLIO</u>	<u>BEGINNING VALUE</u>	<u>NET CONTR</u>	<u>INCOME RECEIVED</u>	<u>GAIN (LOSS)</u>	<u>END VALUE</u>
UBS	39,723	0	0	- 375	39,348
INT'L C/S	39,715	0	0	- 375	39,340
CASH EQUIV	8	0	0	0	8
SSR TOWER FUND	17,003	- 49	0	713	17,668
REAL ESTATE	17,003	- 49	0	713	17,668
SEIX CORE	65,698	0	547	1,226	67,472
BONDS	65,698	0	547	1,226	67,472
SEIX HIGH YIELD	12,269	- 17	193	153	12,598
BONDS	12,269	- 17	193	153	12,598
ALT. ASSETS	741	0	1	- 109	632
CASH EQUIV	159	0	1	0	160
PRIVATE INVEST	582	0	0	- 109	472
VERMONT INVEST	1,170	- 738	- 488	494	438
BONDS	317	0	0	- 5	312
CASH EQUIV	853	- 738	- 488	499	127

VERMONT MUNICIPAL EMPLOYEES

PORTFOLIO ASSET GROWTH BY SEGMENT (\$000)

YEAR TO DATE

<u>PORTFOLIO</u>	<u>BEGINNING VALUE</u>	<u>NET CONTR</u>	<u>INCOME RECEIVED</u>	<u>GAIN (LOSS)</u>	<u>END VALUE</u>
MUNI COMPOSITE	239,747	3,547	1,321	1,123	245,739
COMMON STOCK	107,767	-409	459	-552	107,265
INT'L C/S	41,880	-2,000	0	-540	39,340
BONDS	74,617	3,967	1,332	466	80,382
CASH EQUIV	498	79	-470	505	612
REAL ESTATE	14,404	1,909	0	1,354	17,668
PRIVATE INVEST	582	0	0	-109	472
EQTY COMPOSITE	107,767	-92	459	-552	107,582
COMMON STOCK	107,767	-409	459	-552	107,265
CASH EQUIV	0	317	0	0	317
DELAWARE	41,975	0	459	-455	41,980
COMMON STOCK	41,975	-317	459	-455	41,663
CASH EQUIV	0	317	0	0	317
ALLIANCE	39,569	0	0	-64	39,505
COMMON STOCK	39,569	0	0	-64	39,505
LAZARD	26,223	-92	0	-33	26,098
COMMON STOCK	26,223	-92	0	-33	26,098

VERMONT MUNICIPAL EMPLOYEES

PORTFOLIO ASSET GROWTH BY SEGMENT (\$000)

YEAR TO DATE

<u>PORTFOLIO</u>	<u>BEGINNING VALUE</u>	<u>NET CONTR</u>	<u>INCOME RECEIVED</u>	<u>GAIN (LOSS)</u>	<u>END VALUE</u>
UBS	41,888	- 2,000	- 4	- 536	39,348
INT'L C/S	41,880	- 2,000	0	- 540	39,340
CASH EQUIV	8	0	- 4	4	8
SSR TOWER FUND	14,404	1,909	0	1,354	17,668
REAL ESTATE	14,404	1,909	0	1,354	17,668
SEIX CORE	62,842	3,000	960	670	67,472
BONDS	62,842	3,000	960	670	67,472
SEIX HIGH YIELD	11,461	967	372	- 202	12,598
BONDS	11,461	967	372	- 202	12,598
ALT. ASSETS	740	0	2	- 109	632
CASH EQUIV	158	0	2	0	160
PRIVATE INVEST	582	0	0	- 109	472
VERMONT INVEST	645	- 238	- 468	500	438
BONDS	313	0	0	- 2	312
CASH EQUIV	331	- 238	- 468	501	127

VERMONT MUNICIPAL EMPLOYEES

PORTFOLIO ASSET GROWTH BY SEGMENT (\$000)

YEAR ENDING 6/05

<u>PORTFOLIO</u>	<u>BEGINNING VALUE</u>	<u>NET CONTR</u>	<u>INCOME RECEIVED</u>	<u>GAIN (LOSS)</u>	<u>END VALUE</u>
MUNI COMPOSITE	220,726	6,728	7,938	10,346	245,739
COMMON STOCK	99,540	1,502	5,073	1,149	107,265
INT'L C/S	36,065	-2,000	0	5,275	39,340
BONDS	69,174	5,911	2,815	2,482	80,382
CASH EQUIV	1,069	-511	50	4	612
REAL ESTATE	14,125	1,826	0	1,717	17,668
PRIVATE INVEST	753	0	0	-280	472
EQTY COMPOSITE	99,540	1,819	5,073	1,149	107,582
COMMON STOCK	99,540	1,502	5,073	1,149	107,265
CASH EQUIV	0	317	0	0	317
DELAWARE	39,060	0	879	2,040	41,980
COMMON STOCK	39,060	-316	879	2,040	41,663
CASH EQUIV	0	317	0	0	317
ALLIANCE	36,310	2,000	0	1,195	39,505
COMMON STOCK	36,310	2,000	0	1,195	39,505
LAZARD	24,171	-181	4,195	-2,086	26,098
COMMON STOCK	24,171	-181	4,195	-2,086	26,098

VERMONT MUNICIPAL EMPLOYEES

PORTFOLIO ASSET GROWTH BY SEGMENT (\$000)

YEAR ENDING 6/05

<u>PORTFOLIO</u>	<u>BEGINNING VALUE</u>	<u>NET CONTR</u>	<u>INCOME RECEIVED</u>	<u>GAIN (LOSS)</u>	<u>END VALUE</u>
UBS	36,073	- 2,000	- 4	5,279	39,348
INT'L C/S	36,065	- 2,000	0	5,275	39,340
CASH EQUIV	8	0	- 4	4	8
SSR TOWER FUND	14,125	1,826	0	1,717	17,668
REAL ESTATE	14,125	1,826	0	1,717	17,668
SEIX CORE	58,214	5,000	1,931	2,327	67,472
BONDS	58,214	5,000	1,931	2,327	67,472
SEIX HIGH YIELD	10,632	937	860	170	12,598
BONDS	10,632	937	860	170	12,598
ALT. ASSETS	830	80	2	- 280	632
CASH EQUIV	78	80	2	0	160
PRIVATE INVEST	753	0	0	- 280	472
VERMONT INVEST	1,311	- 934	76	- 15	438
BONDS	328	- 26	24	- 14	312
CASH EQUIV	983	- 908	52	0	127

VERMONT MUNICIPAL EMPLOYEES
PERFORMANCE ANALYSIS
MUNICIPAL SYSTEM COMPOSITE

PERIODS ENDING 6/05

	<u>LAST QTR</u>		<u>LAST 2 QTRS</u>		<u>LAST 3 QTRS</u>		<u>LAST YEAR</u>		<u>LAST 3 YEARS</u>		<u>LAST 5 YEARS</u>	
TOTAL FUND	2.4	34	1.0	63	8.1	62	8.1	61	8.2	71	4.6	37
ALLOCATION IDX	2.3	40	1.0	60	9.1	41	9.5	35	9.6	39	3.0	70
MEDIAN	2.1		1.2		8.8		8.8		9.2		3.9	
EQUITIES	3.3	33	0.0	56	9.7	65	6.2	74	7.8	83	1.8	52
S&P 500	1.4	77	-0.8	74	8.3	80	6.3	72	8.3	78	-2.4	77
R 1000(R) GR	2.5	49	-1.7	83	7.3	87	1.7	93	7.3	87	-10.4	97
R 1000(R) VALUE	1.7	66	1.8	29	12.3	43	14.1	18	11.0	46	6.6	36
R 2000(R)	4.3	19	-1.3	80	12.7	39	9.4	47	12.8	32	5.7	40
MEDIAN	2.4		0.3		11.6		8.7		10.6		2.4	
BONDS	2.7	55	2.3	54	3.5	53	7.5	40	6.4	50	7.5	54
LB AGGREGATE	3.0	41	2.5	45	3.5	55	6.8	56	5.8	64	7.4	59
ML HIGH YLD II	2.6	59	1.1	84	5.7	7	10.6	6	14.2	2	7.1	67
MEDIAN	2.9		2.4		3.6		7.0		6.4		7.7	
INT'L EQUITIES	-1.0	68	-1.4	74	12.8	75	14.6	58	11.3	73		
MS EAFE NET	-1.0	70	-1.2	70	14.0	62	13.7	63	12.1	69	-0.5	81
CITI PMI EPAC	-0.6	58	-0.7	61	14.7	50	14.7	58	12.5	65	0.0	78
MEDIAN	-0.4		0.0		14.8		15.4		13.5		4.2	

VERMONT MUNICIPAL EMPLOYEES
PERFORMANCE ANALYSIS
MUNI POLICY INDEX

PERIODS ENDING 6/05

	<u>LAST QTR</u>		<u>LAST 2 QTRS</u>		<u>LAST 3 QTRS</u>		<u>LAST YEAR</u>		<u>LAST 3 YEARS</u>		<u>LAST 5 YEARS</u>	
TOTAL FUND	2.2	42	0.9	67	8.5	55	9.1	43	9.3	47	3.3	66
MEDIAN	2.1		1.2		8.8		8.8		9.2		3.9	

VERMONT MUNICIPAL EMPLOYEES
PERFORMANCE ANALYSIS
DOMESTIC EQUITY COMPOSITE

PERIODS ENDING 6/05

	<u>LAST QTR</u>		<u>LAST 2 QTRS</u>		<u>LAST 3 QTRS</u>		<u>LAST YEAR</u>		<u>LAST 3 YEARS</u>		<u>LAST 5 YEARS</u>	
TOTAL FUND	3.3	32	0.0	57	9.7	64	6.1	74	7.7	83	1.8	53
ALLOCATION IDX	2.6	47	-0.3	62	10.5	57	8.3	51	9.6	59	-1.4	66
MEDIAN	2.4		0.3		11.5		8.6		10.6		3.1	
EQUITIES	3.3	33	0.0	56	9.7	65	6.2	74	7.8	83	1.8	52
S&P 500	1.4	77	-0.8	74	8.3	80	6.3	72	8.3	78	-2.4	77
R 1000(R) GR	2.5	49	-1.7	83	7.3	87	1.7	93	7.3	87	-10.4	97
R 1000(R) VALUE	1.7	66	1.8	29	12.3	43	14.1	18	11.0	46	6.6	36
R 2000(R)	4.3	19	-1.3	80	12.7	39	9.4	47	12.8	32	5.7	40
MEDIAN	2.4		0.3		11.6		8.7		10.6		2.4	

VERMONT MUNICIPAL EMPLOYEES
PERFORMANCE ANALYSIS
DELAWARE

PERIODS ENDING 6/05

	<u>LAST QTR</u>		<u>LAST 2 QTRS</u>		<u>LAST 3 QTRS</u>		<u>LAST YEAR</u>		<u>LAST 3 YEARS</u>		<u>LAST 5 YEARS</u>	
TOTAL FUND	1.3	79	0.0	56	8.7	72	7.5	57	8.2	78	7.3	35
ALLOCATION IDX	1.7	66	1.8	29	12.3	42	14.1	17	10.5	50	3.6	48
MEDIAN	2.4		0.3		11.5		8.6		10.6		3.1	
EQUITIES	1.3	80	0.0	55	8.8	72	7.5	57	8.2	79	7.3	33
S&P 500	1.4	77	-0.8	74	8.3	80	6.3	72	8.3	78	-2.4	77
R 1000(R) GR	2.5	49	-1.7	83	7.3	87	1.7	93	7.3	87	-10.4	97
R 1000(R) VALUE	1.7	66	1.8	29	12.3	43	14.1	18	11.0	46	6.6	36
R 2000(R)	4.3	19	-1.3	80	12.7	39	9.4	47	12.8	32	5.7	40
MEDIAN	2.4		0.3		11.6		8.7		10.6		2.4	

VERMONT MUNICIPAL EMPLOYEES
PERFORMANCE ANALYSIS
ALLIANCE LARGE CAP GROWTH FUND

PERIODS ENDING 6/05

	LAST QTR		LAST 2 QTRS		LAST 3 QTRS		LAST YEAR		LAST 3 YEARS		LAST 5 YEARS	
TOTAL FUND	6.4	4	-0.2	59	9.1	69	2.8	90	5.1	95	-8.4	95
ALLOCATION IDX	2.5	49	-1.7	84	7.3	87	1.7	93	6.9	88	-10.4	97
MEDIAN	2.4		0.3		11.5		8.6		10.6		3.1	
EQUITIES	6.4	5	-0.2	58	9.1	70	2.8	89	5.3	94	-8.4	96
S&P 500	1.4	77	-0.8	74	8.3	80	6.3	72	8.3	78	-2.4	77
R 1000(R) GR	2.5	49	-1.7	83	7.3	87	1.7	93	7.3	87	-10.4	97
R 1000(R) VALUE	1.7	66	1.8	29	12.3	43	14.1	18	11.0	46	6.6	36
R 2000(R)	4.3	19	-1.3	80	12.7	39	9.4	47	12.8	32	5.7	40
MEDIAN	2.4		0.3		11.6		8.7		10.6		2.4	

VERMONT MUNICIPAL EMPLOYEES
PERFORMANCE ANALYSIS
LAZARD SMALL CAP FUND

PERIODS ENDING 6/05

	<u>LAST QTR</u>		<u>LAST 2 QTRS</u>		<u>LAST 3 QTRS</u>		<u>LAST YEAR</u>		<u>LAST 3 YEARS</u>		<u>LAST 5 YEARS</u>	
TOTAL FUND	2.0	59	0.1	54	12.1	44	9.0	48	11.4	43	12.3	20
ALLOCATION IDX	4.3	18	-1.3	81	12.7	38	9.4	46	12.8	31	5.7	42
MEDIAN	2.4		0.3		11.5		8.6		10.6		3.1	
EQUITIES	2.0	60	0.1	53	12.1	45	9.0	49	11.4	44	12.2	20
S&P 500	1.4	77	-0.8	74	8.3	80	6.3	72	8.3	78	-2.4	77
R 1000(R) GR	2.5	49	-1.7	83	7.3	87	1.7	93	7.3	87	-10.4	97
R 1000(R) VALUE	1.7	66	1.8	29	12.3	43	14.1	18	11.0	46	6.6	36
R 2000(R)	4.3	19	-1.3	80	12.7	39	9.4	47	12.8	32	5.7	40
MEDIAN	2.4		0.3		11.6		8.7		10.6		2.4	

VERMONT MUNICIPAL EMPLOYEES
PERFORMANCE ANALYSIS
SEIX CORE

PERIODS ENDING 6/05

	<u>LAST QTR</u>		<u>LAST 2 QTRS</u>		<u>LAST 3 QTRS</u>		<u>LAST YEAR</u>		<u>LAST 3 YEARS</u>		<u>LAST 5 YEARS</u>	
TOTAL FUND	2.7	55	2.4	51	3.4	64	7.0	49	5.9	60	7.2	66
ALLOCATION IDX	3.0	40	2.5	45	3.5	58	6.8	56	5.8	64	7.4	60
MEDIAN	2.8		2.5		3.7		7.0		6.3		7.7	
BONDS	2.7	55	2.4	49	3.4	60	7.0	49	5.9	60	7.2	64
LB AGGREGATE	3.0	41	2.5	45	3.5	55	6.8	56	5.8	64	7.4	59
ML HIGH YLD II	2.6	59	1.1	84	5.7	7	10.6	6	14.2	2	7.1	67
MEDIAN	2.9		2.4		3.6		7.0		6.4		7.7	

VERMONT MUNICIPAL EMPLOYEES
PERFORMANCE ANALYSIS
SEIX HIGH YIELD

PERIODS ENDING 6/05

	<u>LAST QTR</u>		<u>LAST 2 QTRS</u>		<u>LAST 3 QTRS</u>		<u>LAST YEAR</u>		<u>LAST 3 YEARS</u>		<u>LAST 5 YEARS</u>	
TOTAL FUND	2.8	50	1.3	82	4.3	32	9.5	10				
ALLOCATION IDX	2.6	60	1.3	80	5.1	12	10.1	6				
MEDIAN	2.8		2.5		3.7		7.0		6.3		7.7	
BONDS	2.8	50	1.3	81	4.3	30	9.5	11				
LB AGGREGATE	3.0	41	2.5	45	3.5	55	6.8	56	5.8	64	7.4	59
ML HIGH YLD II	2.6	59	1.1	84	5.7	7	10.6	6	14.2	2	7.1	67
MEDIAN	2.9		2.4		3.6		7.0		6.4		7.7	

VERMONT MUNICIPAL EMPLOYEES
PERFORMANCE ANALYSIS
VERMONT INVESTMENTS

PERIODS ENDING 6/05

	<u>LAST QTR</u>		<u>LAST 2 QTRS</u>		<u>LAST 3 QTRS</u>		<u>LAST YEAR</u>		<u>LAST 3 YEARS</u>		<u>LAST 5 YEARS</u>	
TOTAL FUND	0.5	86	2.3	7	3.4	9	4.3	9	2.5	12	3.7	13
ALLOCATION IDX	1.2	11	1.8	10	2.4	12	3.3	11	2.1	18	3.1	24
MEDIAN	0.7		1.3		1.7		2.0		1.5		2.7	
CASH EQUIV.	0.8	18	2.7	3	3.7	3	4.1	4	2.0	14		
MEDIAN	0.7		1.3		1.7		2.0		1.5		2.6	
BONDS	- 1.6	99	- 0.5	98	0.8	98	3.0	90	2.9	94		
LB AGGREGATE	3.0	41	2.5	45	3.5	55	6.8	56	5.8	64	7.4	59
ML HIGH YLD II	2.6	59	1.1	84	5.7	7	10.6	6	14.2	2	7.1	67
MEDIAN	2.9		2.4		3.6		7.0		6.4		7.7	

VERMONT MUNICIPAL EMPLOYEES
REAL ESTATE SEGMENT RATES OF RETURN
PERIODS ENDING 6/05

		ASSETS AT MKT \$MM	PCT OF ACCT	LAST QTR	LAST 2 QTRS	LAST 3 QTRS	LAST YEAR	LAST 3 YEARS	LAST 5 YEARS
MUNICIPAL SYSTEM COMPOSITE	INCOME APPRECIATION			0.0 4.2	0.0 8.8	0.0 11.4	0.0 11.6	2.9 4.9	2.2 5.2
	TOTAL	17.7	7.2	4.2	8.8	11.4	11.6	7.8	7.3
MET LIFE / SSR TOWER FUND	INCOME APPRECIATION			0.0 4.2	0.0 8.8	0.0 11.4	0.0 11.6	2.9 4.9	2.2 5.2
	TOTAL	17.7	100.0	4.2	8.8	11.4	11.6	7.8	7.3

VERMONT MUNICIPAL EMPLOYEES

PERFORMANCE HISTORY

MUNICIPAL SYSTEM COMPOSITE

QUARTER ENDING	TOTAL FUND	ALLOC INDEX	EQUITY SEGMENT	S&P 500 INDEX	BOND SEGMENT	LEHMN AGG INDX	CASH SEGMENT	91-DAY T-BILL
09/ 95	5. 8	5. 1						
12/ 95	4. 5	4. 6						
03/ 96	2. 4	2. 9						
06/ 96	3. 6	2. 5	3. 2	4. 5	0. 4	0. 6		
ANNUAL	17. 4	16. 0						
09/ 96	2. 8	1. 9	3. 6	3. 1	2. 1	1. 8		
12/ 96	6. 3	4. 9	9. 6	8. 3	3. 5	3. 0		
03/ 97	0. 3	0. 4	0. 8	2. 7	- 0. 1	- 0. 6		
06/ 97	10. 4	11. 6	17. 7	17. 5	3. 7	3. 7		
ANNUAL	20. 9	19. 8	34. 7	34. 7	9. 5	8. 2		
09/ 97	7. 0	5. 1	11. 3	7. 5	3. 4	3. 3		
12/ 97	0. 6	0. 3	0. 6	2. 9	2. 0	2. 9		
03/ 98	10. 1	10. 5	16. 5	13. 9	- 1. 5	1. 5		
06/ 98	2. 2	2. 4	3. 2	3. 3	1. 8	2. 3		
ANNUAL	21. 0	19. 2	34. 5	30. 2	5. 8	10. 5		
09/ 98	- 4. 2	- 5. 9	- 12. 2	- 9. 9	5. 4	4. 2		
12/ 98	13. 2	14. 0	22. 0	21. 3	2. 6	0. 3		
03/ 99	2. 7	2. 4	6. 1	5. 0	- 1. 5	- 0. 5		
06/ 99	2. 6	3. 3	5. 5	7. 0	- 1. 3	- 0. 9		
ANNUAL	14. 3	13. 4	19. 9	22. 8	5. 1	3. 1		
09/ 99	- 2. 7	- 1. 7	- 7. 7	- 6. 2	0. 6	0. 7		
12/ 99	6. 9	10. 7	10. 9	14. 9	- 0. 5	- 0. 1		
03/ 00	1. 4	5. 0	1. 9	2. 3	2. 4	2. 2		
06/ 00	0. 4	- 1. 3	- 1. 6	- 2. 7	1. 8	1. 7		
ANNUAL	5. 9	12. 7	2. 7	7. 3	4. 3	4. 6		

VERMONT MUNICIPAL EMPLOYEES

PERFORMANCE HISTORY

MUNICIPAL SYSTEM COMPOSITE

<u>QUARTER ENDING</u>	<u>INT'L C/S</u>	<u>INT'L BOND</u>	<u>CONV</u>	<u>MORT</u>	<u>REAL ESTATE</u>	<u>SV ASSETS</u>	<u>PRVT INVEST</u>	<u>MISC</u>
09/ 95								5.8
12/ 95								4.5
03/ 96								2.4
06/ 96					1.1		3.1	
ANNUAL								
09/ 96					2.2		-1.3	
12/ 96					2.2		0.0	
03/ 97					2.0		1.3	
06/ 97					2.2		-2.0	
ANNUAL					8.8		-2.0	
09/ 97					3.1		1.6	
12/ 97					3.0		-1.0	
03/ 98					3.6		0.0	
06/ 98					3.1		0.0	
ANNUAL					13.4		0.7	
09/ 98					3.4		0.0	
12/ 98					3.2		0.0	
03/ 99					2.3		0.0	
06/ 99					3.2		11.2	
ANNUAL					12.7		11.2	
09/ 99					2.5		0.0	
12/ 99					2.9		0.0	
03/ 00					2.8		0.0	
06/ 00					2.3		53.7	
ANNUAL					11.0		53.8	

VERMONT MUNICIPAL EMPLOYEES

PERFORMANCE HISTORY

MUNICIPAL SYSTEM COMPOSITE

QUARTER ENDING	TOTAL FUND	ALLOC INDEX	EQUITY SEGMENT	S&P 500 INDEX	BOND SEGMENT	LEHMN AGG INDX	CASH SEGMENT	91-DAY T-BILL
09/00	0.5	0.3	1.0	-1.0	3.3	3.0		
12/00	1.2	-3.2	-2.1	-7.8	4.5	4.2		
03/01	-4.4	-6.3	-9.1	-11.9	3.0	3.0		
06/01	3.5	3.5	6.7	5.9	0.7	0.6	1.1	1.1
ANNUAL	0.6	-5.7	-4.1	-14.8	11.9	11.2		
09/01	-5.7	-8.8	-12.6	-14.7	4.6	4.6	0.9	1.1
12/01	6.1	6.6	13.7	10.7	-1.2	0.0	0.5	0.6
03/02	-1.6	0.4	-2.4	0.3	0.1	0.1	0.5	0.4
06/02	-3.5	-4.2	-10.5	-13.4	3.1	3.7	0.4	0.5
ANNUAL	-1.8	-6.5	-9.0	-18.0	6.7	8.6	2.3	2.6
09/02	-9.7	-9.4	-17.8	-17.3	2.7	4.6	0.5	0.5
12/02	4.3	4.6	5.2	8.4	2.2	1.6	0.3	0.4
03/03	-2.3	-2.2	-3.6	-3.1	1.6	1.4	0.3	0.3
06/03	10.7	11.3	16.1	15.4	3.0	2.5	0.2	0.3
ANNUAL	1.9	3.2	-3.2	0.3	9.8	10.4	1.3	1.5
09/03	3.3	3.5	4.4	2.6	0.2	-0.1	0.3	0.2
12/03	8.1	9.2	11.8	12.2	1.1	0.3	0.2	0.3
03/04	2.4	3.0	2.5	1.7	2.6	2.7	0.3	0.2
06/04	0.4	0.1	1.9	1.7	-1.9	-2.4	0.1	0.2
ANNUAL	14.8	16.5	21.8	19.1	1.9	0.3	0.9	1.0
09/04	0.0	0.3	-3.2	-1.9	3.8	3.2	0.3	0.4
12/04	7.1	8.0	9.7	9.2	1.2	1.0	0.9	0.5
03/05	-1.4	-1.2	-3.3	-2.1	-0.4	-0.5	1.6	0.6
06/05	2.4	2.3	3.3	1.4	2.7	3.0	0.7	0.7
ANNUAL	8.1	9.5	6.2	6.3	7.5	6.8	3.6	2.2
HISTORICAL CUMULATIVE	160.1	145.8	151.8	114.0	83.0	85.3	9.4	8.7
ANNUAL EQUIVALENT	10.0	9.4	10.5	8.6	6.8	6.9	2.1	2.0

VERMONT MUNICIPAL EMPLOYEES

PERFORMANCE HISTORY

MUNICIPAL SYSTEM COMPOSITE

<u>QUARTER ENDING</u>	<u>INT'L C/S</u>	<u>INT'L BOND</u>	<u>CONV</u>	<u>MORT</u>	<u>REAL ESTATE</u>	<u>SV ASSETS</u>	<u>PRVT INVEST</u>	<u>MISC</u>
09/00					2.8		0.0	
12/00					4.4		0.0	
03/01					1.8		1.9	
06/01	2.1				1.8		5.9	
ANNUAL					11.3		8.0	
09/01	-11.0				0.6		0.0	
12/01	7.7				0.6		0.0	
03/02	3.3				0.0		0.0	
06/02	-0.3				0.9		-22.2	
ANNUAL	-1.3				2.1		-22.2	
09/02	-20.3				0.4		0.0	
12/02	8.9				0.6		0.0	
03/03	-8.1				1.8		0.0	
06/03	18.2				2.1		-7.2	
ANNUAL	-5.7				5.0		-7.2	
09/03	6.9				2.4		0.0	
12/03	16.3				0.6		0.0	
03/04	2.8				1.0		0.0	
06/04	-0.2				2.9		0.0	
ANNUAL	27.7				7.0		0.0	
09/04	1.6				0.2		0.0	
12/04	14.3				2.4		-22.7	
03/05	-0.4				4.4		0.0	
06/05	-1.0				4.2		-18.8	
ANNUAL	14.6				11.6		-37.3	
HISTORICAL CUMULATIVE	39.0				122.2		-14.9	
ANNUAL EQUIVALENT	8.1				9.0		-1.7	

VERMONT MUNICIPAL EMPLOYEES

PERFORMANCE HISTORY

MUNI POLICY INDEX

QUARTER ENDING	TOTAL FUND	ALLOC INDEX	EQUITY SEGMENT	S&P 500 INDEX	BOND SEGMENT	LEHMN AGG INDX	CASH SEGMENT	91-DAY T-BILL
09/ 95	4. 3							
12/ 95	4. 5							
03/ 96	2. 0							
06/ 96	2. 7							
ANNUAL	14. 2							
09/ 96	2. 6							
12/ 96	5. 4							
03/ 97	1. 0							
06/ 97	10. 6							
ANNUAL	20. 8							
09/ 97	5. 0							
12/ 97	2. 1							
03/ 98	8. 4							
06/ 98	2. 9							
ANNUAL	19. 5							
09/ 98	- 4. 2							
12/ 98	12. 3							
03/ 99	2. 5							
06/ 99	3. 4							
ANNUAL	14. 0							
09/ 99	- 1. 6							
12/ 99	8. 9							
03/ 00	2. 1							
06/ 00	- 0. 8							
ANNUAL	8. 6							

VERMONT MUNICIPAL EMPLOYEES

PERFORMANCE HISTORY

MUNI POLICY INDEX

QUARTER ENDING	TOTAL FUND	ALLOC INDEX	EQUITY SEGMENT	S&P 500 INDEX	BOND SEGMENT	LEHMN AGG INDX	CASH SEGMENT	91-DAY T-BILL
09/00	- 0.2							
12/00	- 2.1							
03/01	- 6.2							
06/01	3.7							
ANNUAL	- 5.0							
09/01	- 8.3							
12/01	7.0							
03/02	1.0							
06/02	- 4.4							
ANNUAL	- 5.3							
09/02	- 10.2							
12/02	5.2							
03/03	- 2.0							
06/03	11.4							
ANNUAL	3.2							
09/03	3.5							
12/03	8.8							
03/04	3.0							
06/04	0.1							
ANNUAL	16.1							
09/04	0.5							
12/04	7.6							
03/05	- 1.3							
06/05	2.2							
ANNUAL	9.1							
HISTORICAL CUMULATIVE	140.2							
ANNUAL EQUIVALENT	9.2							

VERMONT MUNICIPAL EMPLOYEES

PERFORMANCE HISTORY

DOMESTIC EQUITY COMPOSITE

QUARTER ENDING	TOTAL FUND	ALLOC INDEX	EQUITY SEGMENT	S&P 500 INDEX	BOND SEGMENT	LEHMN AGG INDX	CASH SEGMENT	91-DAY T-BILL
09/ 95								
12/ 95								
03/ 96								
06/ 96	3. 2	4. 0	3. 2	4. 5				
ANNUAL								
09/ 96	3. 6	3. 1	3. 6	3. 1				
12/ 96	9. 6	7. 9	9. 6	8. 3				
03/ 97	0. 8	1. 2	0. 8	2. 7				
06/ 97	17. 7	16. 5	17. 7	17. 5				
ANNUAL	34. 7	31. 2	34. 7	34. 7				
09/ 97	11. 3	8. 4	11. 3	7. 5				
12/ 97	0. 6	1. 9	0. 6	2. 9				
03/ 98	16. 5	13. 2	16. 5	13. 9				
06/ 98	3. 2	2. 7	3. 2	3. 3				
ANNUAL	34. 5	28. 3	34. 5	30. 2				
09/ 98	- 12. 2	- 11. 0	- 12. 2	- 9. 9				
12/ 98	22. 0	22. 4	22. 0	21. 3				
03/ 99	6. 1	4. 7	6. 1	5. 0				
06/ 99	5. 5	6. 9	5. 5	7. 0				
ANNUAL	19. 9	22. 0	19. 9	22. 8				
09/ 99	- 7. 7	- 6. 3	- 7. 7	- 6. 2				
12/ 99	10. 9	18. 0	10. 9	14. 9				
03/ 00	1. 9	5. 3	1. 9	2. 3				
06/ 00	- 1. 6	- 3. 2	- 1. 6	- 2. 7				
ANNUAL	2. 7	12. 8	2. 7	7. 3				

VERMONT MUNICIPAL EMPLOYEES

PERFORMANCE HISTORY

DOMESTIC EQUITY COMPOSITE

QUARTER ENDING	TOTAL FUND	ALLOC INDEX	EQUITY SEGMENT	S&P 500 INDEX	BOND SEGMENT	LEHMN AGG INDX	CASH SEGMENT	91-DAY T-BILL
09/ 00	1. 0	0. 7	1. 0	- 1. 0				
12/ 00	- 2. 1	- 9. 8	- 2. 1	- 7. 8				
03/ 01	- 9. 1	- 11. 7	- 9. 1	- 11. 9				
06/ 01	6. 7	8. 0	6. 7	5. 9				
ANNUAL	- 4. 1	- 13. 4	- 4. 1	- 14. 8				
09/ 01	- 12. 6	- 18. 4	- 12. 6	- 14. 7			0. 7	1. 1
12/ 01	13. 7	13. 5	13. 7	10. 7			0. 7	0. 6
03/ 02	- 2. 4	0. 7	- 2. 4	0. 3			0. 4	0. 4
06/ 02	- 10. 4	- 12. 5	- 10. 5	- 13. 4			0. 5	0. 5
ANNUAL	- 8. 7	- 18. 3	- 9. 0	- 18. 0			2. 4	2. 6
09/ 02	- 17. 6	- 18. 4	- 17. 8	- 17. 3			0. 5	0. 5
12/ 02	4. 9	6. 7	5. 2	8. 4			0. 4	0. 4
03/ 03	- 3. 6	- 3. 3	- 3. 6	- 3. 1				
06/ 03	16. 1	17. 5	16. 1	15. 4				
ANNUAL	- 3. 3	- 1. 0	- 3. 2	0. 3				
09/ 03	4. 4	4. 4	4. 4	2. 6				
12/ 03	11. 8	12. 9	11. 8	12. 2				
03/ 04	2. 5	3. 0	2. 5	1. 7				
06/ 04	1. 9	1. 2	1. 9	1. 7				
ANNUAL	21. 8	22. 8	21. 8	19. 1				
09/ 04	- 3. 2	- 2. 0	- 3. 2	- 1. 9				
12/ 04	9. 7	10. 8	9. 7	9. 2				
03/ 05	- 3. 3	- 2. 8	- 3. 3	- 2. 1				
06/ 05	3. 3	2. 6	3. 3	1. 4			0. 0	0. 7
ANNUAL	6. 1	8. 3	6. 2	6. 3				
HISTORICAL CUMULATIVE	152. 1	124. 2	151. 8	114. 0			0. 0	0. 7
ANNUAL EQUIVALENT	10. 5	9. 1	10. 5	8. 6			0. 0	0. 7

VERMONT MUNICIPAL EMPLOYEES

PERFORMANCE HISTORY

DELAWARE

QUARTER ENDING	TOTAL FUND	ALLOC INDEX	EQUITY SEGMENT	S&P 500 INDEX	BOND SEGMENT	LEHMN AGG INDX	CASH SEGMENT	91-DAY T-BILL
09/ 95	8. 3	8. 0	8. 3	7. 9				
12/ 95	6. 7	6. 5	6. 7	6. 0				
03/ 96	5. 3	6. 4	5. 3	5. 4				
06/ 96	2. 7	2. 0	2. 7	4. 5				
ANNUAL	25. 1	24. 8	25. 1	25. 9				
09/ 96	4. 0	2. 6	4. 0	3. 1				
12/ 96	8. 4	9. 5	8. 4	8. 3				
03/ 97	2. 4	1. 8	2. 4	2. 7				
06/ 97	15. 7	14. 5	15. 7	17. 5				
ANNUAL	33. 6	30. 9	33. 6	34. 7				
09/ 97	9. 0	9. 2	9. 0	7. 5				
12/ 97	2. 5	2. 2	2. 5	2. 9				
03/ 98	11. 5	11. 6	11. 5	13. 9				
06/ 98	- 0. 8	0. 5	- 0. 8	3. 3				
ANNUAL	23. 5	25. 1	23. 5	30. 2				
09/ 98	- 12. 0	- 12. 9	- 12. 0	- 9. 9				
12/ 98	14. 0	17. 4	14. 0	21. 3				
03/ 99	- 0. 3	2. 9	- 0. 3	5. 0				
06/ 99	6. 7	10. 8	6. 7	7. 0				
ANNUAL	6. 7	16. 5	6. 7	22. 8				
09/ 99	- 9. 6	- 9. 2	- 9. 6	- 6. 2				
12/ 99	3. 5	9. 0	3. 5	14. 9				
03/ 00	- 5. 3	0. 2	- 5. 3	2. 3				
06/ 00	0. 1	- 4. 3	0. 1	- 2. 7				
ANNUAL	- 11. 3	- 5. 1	- 11. 3	7. 3				

VERMONT MUNICIPAL EMPLOYEES

PERFORMANCE HISTORY

DELAWARE

QUARTER ENDING	TOTAL FUND	ALLOC INDEX	EQUITY SEGMENT	S&P 500 INDEX	BOND SEGMENT	LEHMN AGG INDX	CASH SEGMENT	91-DAY T-BILL
09/ 00	8.7	8.8	8.7	- 1.0				
12/ 00	10.0	1.6	10.0	- 7.8				
03/ 01	- 3.9	- 6.5	- 3.9	- 11.9				
06/ 01	3.9	4.4	3.9	5.9				
ANNUAL	19.3	7.9	19.3	- 14.8				
09/ 01	- 11.4	- 16.2	- 11.4	- 14.7			0.7	1.1
12/ 01	8.6	8.0	8.6	10.7			0.7	0.6
03/ 02	- 5.5	1.3	- 5.6	0.3			0.4	0.4
06/ 02	- 7.5	- 10.6	- 7.6	- 13.4			0.6	0.5
ANNUAL	- 6.1	- 18.1	- 6.1	- 18.0			2.4	2.6
09/ 02	- 18.6	- 20.3	- 18.7	- 17.3			0.5	0.5
12/ 02	8.0	9.9	8.0	8.4			0.5	0.4
03/ 03	- 5.4	- 4.9	- 5.4	- 3.1				
06/ 03	18.2	17.3	18.2	15.4				
ANNUAL	- 1.7	- 2.3	- 1.7	0.3				
09/ 03	2.6	2.1	2.6	2.6				
12/ 03	12.9	14.2	12.9	12.2				
03/ 04	1.8	3.0	1.8	1.7				
06/ 04	1.9	0.9	1.9	1.7				
ANNUAL	20.0	21.1	20.0	19.1				
09/ 04	- 1.2	1.5	- 1.2	- 1.9				
12/ 04	8.7	10.4	8.8	9.2				
03/ 05	- 1.3	0.1	- 1.3	- 2.1				
06/ 05	1.3	1.7	1.3	1.4			0.0	0.7
ANNUAL	7.5	14.1	7.5	6.3				
HISTORICAL CUMULATIVE	177.4	169.9	177.3	157.9			0.0	0.7
ANNUAL EQUIVALENT	10.7	10.4	10.7	9.9			0.0	0.7

VERMONT MUNICIPAL EMPLOYEES

PERFORMANCE HISTORY

ALLIANCE LARGE CAP GROWTH FUND

QUARTER ENDING	TOTAL FUND	ALLOC INDEX	EQUITY SEGMENT	S&P 500 INDEX	BOND SEGMENT	LEHMN AGG INDX	CASH SEGMENT	91-DAY T-BILL
09/ 95	11. 8	9. 1	11. 8	7. 9				
12/ 95	- 0. 5	4. 6	- 0. 5	6. 0				
03/ 96	7. 4	5. 4	7. 4	5. 4				
06/ 96	3. 8	6. 4	3. 8	4. 5				
ANNUAL	24. 0	27. 8	24. 0	25. 9				
09/ 96	3. 2	3. 6	3. 2	3. 1				
12/ 96	11. 0	6. 0	11. 0	8. 3				
03/ 97	- 1. 2	0. 5	- 1. 2	2. 7				
06/ 97	20. 1	18. 9	20. 1	17. 5				
ANNUAL	36. 0	31. 3	36. 0	34. 7				
09/ 97	13. 3	7. 5	13. 3	7. 5				
12/ 97	- 1. 8	1. 5	- 1. 8	2. 9				
03/ 98	21. 6	15. 2	21. 6	13. 9				
06/ 98	8. 3	4. 5	8. 3	3. 3				
ANNUAL	46. 6	31. 4	46. 6	30. 2				
09/ 98	- 12. 5	- 9. 1	- 12. 5	- 9. 9				
12/ 98	32. 0	26. 7	32. 0	21. 3				
03/ 99	10. 8	6. 4	10. 8	5. 0				
06/ 99	3. 8	3. 8	3. 8	7. 0				
ANNUAL	32. 8	27. 3	32. 8	22. 8				
09/ 99	- 5. 2	- 3. 7	- 5. 2	- 6. 2				
12/ 99	21. 7	25. 1	21. 7	14. 9				
03/ 00	6. 6	7. 1	6. 6	2. 3				
06/ 00	- 3. 3	- 2. 7	- 3. 3	- 2. 7				
ANNUAL	18. 9	25. 6	18. 9	7. 3				

VERMONT MUNICIPAL EMPLOYEES

PERFORMANCE HISTORY

ALLIANCE LARGE CAP GROWTH FUND

QUARTER ENDING	TOTAL FUND	ALLOC INDEX	EQUITY SEGMENT	S&P 500 INDEX	BOND SEGMENT	LEHMN AGG INDX	CASH SEGMENT	91-DAY T-BILL
09/00	- 5.8	- 5.4	- 5.8	- 1.0				
12/00	- 14.9	- 21.3	- 14.9	- 7.8				
03/01	- 17.4	- 20.9	- 17.4	- 11.9				
06/01	6.3	8.4	6.3	5.9				
ANNUAL	- 29.6	- 36.2	- 29.6	- 14.8				
09/01	- 15.5	- 19.4	- 15.5	- 14.7			1.0	1.1
12/01	15.2	15.1	15.2	10.7			0.7	0.6
03/02	- 4.6	- 2.6	- 4.6	0.3			0.5	0.4
06/02	- 14.9	- 17.9	- 15.5	- 13.4			0.5	0.5
ANNUAL	- 21.0	- 25.8	- 21.5	- 18.0			2.8	2.6
09/02	- 15.0	- 13.6	- 15.0	- 17.3			0.5	0.5
12/02	1.8	4.2	2.5	8.4				
03/03	- 1.1	- 1.1	- 1.1	- 3.1				
06/03	12.7	14.3	12.7	15.4				
ANNUAL	- 3.5	1.8	- 2.8	0.3				
09/03	3.9	3.9	3.9	2.6				
12/03	8.8	10.4	8.8	12.2				
03/04	1.6	0.8	1.6	1.7				
06/04	1.8	1.9	1.8	1.7				
ANNUAL	16.9	17.9	16.9	19.1				
09/04	- 5.7	- 5.2	- 5.7	- 1.9				
12/04	9.2	9.2	9.2	9.2				
03/05	- 6.2	- 4.1	- 6.2	- 2.1				
06/05	6.4	2.5	6.4	1.4				
ANNUAL	2.8	1.7	2.8	6.3				
HISTORICAL CUMULATIVE	151.7	103.7	151.6	157.9				
ANNUAL EQUIVALENT	9.7	7.4	9.7	9.9				

VERMONT MUNICIPAL EMPLOYEES

PERFORMANCE HISTORY

LAZARD SMALL CAP FUND

<u>QUARTER ENDING</u>	<u>TOTAL FUND</u>	<u>ALLOC INDEX</u>	<u>EQUITY SEGMENT</u>	<u>S&P 500 INDEX</u>	<u>BOND SEGMENT</u>	<u>LEHMN AGG INDX</u>	<u>CASH SEGMENT</u>	<u>91-DAY T-BILL</u>
09/ 95								
12/ 95								
03/ 96								
06/ 96								
ANNUAL								
09/ 96								
12/ 96								
03/ 97								
06/ 97								
ANNUAL								
09/ 97								
12/ 97								
03/ 98								
06/ 98								
ANNUAL								
09/ 98								
12/ 98								
03/ 99								
06/ 99								
ANNUAL								
09/ 99	- 9.2	- 6.3	- 9.2	- 6.2				
12/ 99	1.0	18.4	1.0	14.9				
03/ 00	3.9	7.1	3.9	2.3				
06/ 00	0.2	- 3.8	0.2	- 2.7				
ANNUAL	- 4.5	14.3	- 4.5	7.3				

VERMONT MUNICIPAL EMPLOYEES

PERFORMANCE HISTORY

LAZARD SMALL CAP FUND

QUARTER ENDING	TOTAL FUND	ALLOC INDEX	EQUITY SEGMENT	S&P 500 INDEX	BOND SEGMENT	LEHMN AGG INDX	CASH SEGMENT	91-DAY T-BILL
09/00	5.0	1.1	5.0	-1.0				
12/00	6.0	-6.9	6.0	-7.8				
03/01	-2.9	-6.5	-2.9	-11.9				
06/01	13.1	14.3	13.1	5.9				
ANNUAL	22.2	0.6	22.2	-14.8				
09/01	-10.1	-20.8	-10.3	-14.7				
12/01	20.6	21.1	20.6	10.7				
03/02	7.2	4.0	7.2	0.3				
06/02	-9.1	-8.4	-9.1	-13.4				
ANNUAL	5.6	-8.6	5.4	-18.0				
09/02	-19.3	-21.4	-19.3	-17.3				
12/02	5.1	6.2	5.1	8.4				
03/03	-4.9	-4.5	-4.9	-3.1				
06/03	18.4	23.4	18.4	15.4				
ANNUAL	-4.4	-1.6	-4.4	0.3				
09/03	8.3	9.1	8.3	2.6				
12/03	14.7	14.5	14.7	12.2				
03/04	4.9	6.3	4.9	1.7				
06/04	1.7	0.5	1.7	1.7				
ANNUAL	32.5	33.4	32.5	19.1				
09/04	-2.7	-2.9	-2.7	-1.9				
12/04	11.9	14.1	11.9	9.2				
03/05	-1.8	-5.3	-1.8	-2.1				
06/05	2.0	4.3	2.0	1.4				
ANNUAL	9.0	9.4	9.0	6.3				
HISTORICAL CUMULATIVE	70.1	50.9	69.8	-4.9				
ANNUAL EQUIVALENT	9.3	7.1	9.2	-0.8				

VERMONT MUNICIPAL EMPLOYEES

PERFORMANCE HISTORY

BRINSON - UBS

QUARTER ENDING	TOTAL FUND	ALLOC INDEX	EQUITY SEGMENT	S&P 500 INDEX	BOND SEGMENT	LEHMN AGG INDX	CASH SEGMENT	91-DAY T-BILL
09/ 95	6. 1	4. 2						
12/ 95	5. 8	4. 0						
03/ 96	1. 4	2. 9						
06/ 96	2. 6	1. 6						
ANNUAL	16. 8	13. 3						
09/ 96	2. 7	- 0. 1						
12/ 96	4. 4	1. 6						
03/ 97	- 1. 4	- 1. 6						
06/ 97	7. 1	13. 0						
ANNUAL	13. 2	12. 8						
09/ 97	2. 4	- 0. 7						
12/ 97	- 1. 5	- 7. 8						
03/ 98	5. 4	14. 7						
06/ 98	0. 9	1. 1						
ANNUAL	7. 2	6. 1						
09/ 98	- 0. 2	- 14. 2						
12/ 98	18. 0	20. 7						
03/ 99	- 0. 1	1. 4						
06/ 99	3. 6	2. 5						
ANNUAL	21. 9	7. 6						
09/ 99	2. 6	4. 4						
12/ 99	14. 8	17. 0						
03/ 00	- 3. 4	- 0. 1						
06/ 00	0. 7	- 4. 0						
ANNUAL	14. 4	17. 2						

VERMONT MUNICIPAL EMPLOYEES

PERFORMANCE HISTORY

BRINSON - UBS

<u>QUARTER ENDING</u>	<u>INT'L C/S</u>	<u>INT'L BOND</u>	<u>CONV</u>	<u>MORT</u>	<u>REAL ESTATE</u>	<u>SV ASSETS</u>	<u>PRVT INVEST</u>	<u>MISC</u>
09/ 95	6. 1							
12/ 95	5. 8							
03/ 96	1. 4							
06/ 96	2. 6							
ANNUAL	16. 8							
09/ 96	2. 7							
12/ 96	4. 4							
03/ 97	- 1. 4							
06/ 97	7. 1							
ANNUAL	13. 2							
09/ 97	2. 4							
12/ 97	- 1. 5							
03/ 98	5. 4							
06/ 98	0. 9							
ANNUAL	7. 2							
09/ 98	- 0. 2							
12/ 98	18. 0							
03/ 99	- 0. 1							
06/ 99	3. 6							
ANNUAL	21. 9							
09/ 99	2. 6							
12/ 99	14. 8							
03/ 00	- 3. 4							
06/ 00	0. 7							
ANNUAL	14. 4							

VERMONT MUNICIPAL EMPLOYEES

PERFORMANCE HISTORY

BRINSON - UBS

QUARTER ENDING	TOTAL FUND	ALLOC INDEX	EQUITY SEGMENT	S&P 500 INDEX	BOND SEGMENT	LEHMN AGG INDX	CASH SEGMENT	91-DAY T-BILL
09/00	- 7.3	- 8.1						
12/00	1.9	- 2.7						
03/01	- 11.7	- 13.6						
06/01	2.1	- 1.0						
ANNUAL	- 14.8	- 23.5						
09/01	- 11.0	- 14.0						
12/01	7.7	7.0					0.7	0.6
03/02	3.3	0.5					0.4	0.4
06/02	- 0.3	- 2.1					0.6	0.5
ANNUAL	- 1.3	- 9.5						
09/02	- 20.3	- 19.7					0.5	0.5
12/02	8.9	6.5					0.4	0.4
03/03	- 8.1	- 8.2					0.4	0.3
06/03	18.2	19.3					0.5	0.3
ANNUAL	- 5.6	- 6.5					1.8	1.5
09/03	6.9	8.1					0.3	0.2
12/03	16.3	17.1					0.3	0.3
03/04	2.8	4.3					0.3	0.2
06/04	- 0.2	0.2					0.3	0.2
ANNUAL	27.7	32.4					1.2	1.0
09/04	1.6	- 0.3					0.3	0.4
12/04	14.3	15.3					0.4	0.5
03/05	- 0.4	- 0.2					0.4	0.6
06/05	- 1.0	- 1.0					0.7	0.7
ANNUAL	14.6	13.7					1.9	2.2
HISTORICAL CUMULATIVE	129.6	66.6					6.7	6.3
ANNUAL EQUIVALENT	8.7	5.2					1.7	1.7

VERMONT MUNICIPAL EMPLOYEES

PERFORMANCE HISTORY

BRINSON - UBS

<u>QUARTER ENDING</u>	<u>INT'L C/S</u>	<u>INT'L BOND</u>	<u>CONV</u>	<u>MORT</u>	<u>REAL ESTATE</u>	<u>SV ASSETS</u>	<u>PRVT INVEST</u>	<u>MISC</u>
09/00	- 7.3							
12/00	1.9							
03/01	- 11.7							
06/01	2.1							
ANNUAL	- 14.8							
09/01	- 11.0							
12/01	7.7							
03/02	3.3							
06/02	- 0.3							
ANNUAL	- 1.3							
09/02	- 20.3							
12/02	8.9							
03/03	- 8.1							
06/03	18.2							
ANNUAL	- 5.7							
09/03	6.9							
12/03	16.3							
03/04	2.8							
06/04	- 0.2							
ANNUAL	27.7							
09/04	1.6							
12/04	14.3							
03/05	- 0.4							
06/05	- 1.0							
ANNUAL	14.6							
HISTORICAL CUMULATIVE	129.5							
ANNUAL EQUIVALENT	8.7							

VERMONT MUNICIPAL EMPLOYEES

PERFORMANCE HISTORY

MET LIFE / SSR TOWER FUND

QUARTER ENDING	TOTAL FUND	ALLOC INDEX	EQUITY SEGMENT	S&P 500 INDEX	BOND SEGMENT	LEHMN AGG INDX	CASH SEGMENT	91-DAY T-BILL
09/ 95	0. 0	2. 2						
12/ 95	5. 9	1. 8						
03/ 96	- 3. 7	2. 6						
06/ 96	1. 1	2. 6						
ANNUAL	3. 1	9. 6						
09/ 96	2. 2	3. 0						
12/ 96	2. 2	2. 5						
03/ 97	2. 0	2. 5						
06/ 97	2. 2	3. 1						
ANNUAL	8. 8	11. 6						
09/ 97	3. 1	3. 7						
12/ 97	3. 0	4. 7						
03/ 98	3. 6	4. 1						
06/ 98	3. 1	4. 6						
ANNUAL	13. 4	18. 2						
09/ 98	3. 4	3. 9						
12/ 98	3. 2	3. 7						
03/ 99	2. 3	2. 7						
06/ 99	3. 2	2. 8						
ANNUAL	12. 7	13. 7						
09/ 99	2. 5	3. 1						
12/ 99	2. 9	2. 8						
03/ 00	2. 8	2. 6						
06/ 00	2. 3	3. 4						
ANNUAL	11. 0	12. 5						

VERMONT MUNICIPAL EMPLOYEES

PERFORMANCE HISTORY

MET LIFE / SSR TOWER FUND

<u>QUARTER ENDING</u>	<u>INT'L C/S</u>	<u>INT'L BOND</u>	<u>CONV</u>	<u>MORT</u>	<u>REAL ESTATE</u>	<u>SV ASSETS</u>	<u>PRVT INVEST</u>	<u>MISC</u>
09/ 95					0. 0			
12/ 95					5. 9			
03/ 96					- 3. 7			
06/ 96					1. 1			
ANNUAL					3. 1			
09/ 96					2. 2			
12/ 96					2. 2			
03/ 97					2. 0			
06/ 97					2. 2			
ANNUAL					8. 8			
09/ 97					3. 1			
12/ 97					3. 0			
03/ 98					3. 6			
06/ 98					3. 1			
ANNUAL					13. 4			
09/ 98					3. 4			
12/ 98					3. 2			
03/ 99					2. 3			
06/ 99					3. 2			
ANNUAL					12. 7			
09/ 99					2. 5			
12/ 99					2. 9			
03/ 00					2. 8			
06/ 00					2. 3			
ANNUAL					11. 0			

VERMONT MUNICIPAL EMPLOYEES

PERFORMANCE HISTORY

MET LIFE / SSR TOWER FUND

QUARTER ENDING	TOTAL FUND	ALLOC INDEX	EQUITY SEGMENT	S&P 500 INDEX	BOND SEGMENT	LEHMN AGG INDX	CASH SEGMENT	91-DAY T-BILL
09/ 00	2. 8	3. 2						
12/ 00	4. 4	3. 1						
03/ 01	1. 8	2. 3						
06/ 01	1. 8	2. 3						
ANNUAL	11. 3	11. 4						
09/ 01	0. 6	2. 4						
12/ 01	0. 6	1. 4						
03/ 02	0. 0	0. 7						
06/ 02	0. 9	1. 1						
ANNUAL	2. 1	5. 7						
09/ 02	0. 4	1. 0						
12/ 02	0. 6	1. 3						
03/ 03	1. 8	1. 3						
06/ 03	2. 1	1. 9						
ANNUAL	5. 0	5. 6						
09/ 03	2. 4	2. 1						
12/ 03	0. 6	4. 0						
03/ 04	1. 0	2. 8						
06/ 04	2. 9	2. 6						
ANNUAL	7. 0	11. 9						
09/ 04	0. 2	3. 4						
12/ 04	2. 4	3. 4						
03/ 05	4. 4	4. 7						
06/ 05	4. 2	5. 3						
ANNUAL	11. 6	18. 0						
HISTORICAL CUMULATIVE	126. 5	203. 2						
ANNUAL EQUIVALENT	8. 5	11. 7						

VERMONT MUNICIPAL EMPLOYEES

PERFORMANCE HISTORY

MET LIFE / SSR TOWER FUND

<u>QUARTER ENDING</u>	<u>INT'L C/S</u>	<u>INT'L BOND</u>	<u>CONV</u>	<u>MORT</u>	<u>REAL ESTATE</u>	<u>SV ASSETS</u>	<u>PRVT INVEST</u>	<u>MISC</u>
09/ 00					2. 8			
12/ 00					4. 4			
03/ 01					1. 8			
06/ 01					1. 8			
ANNUAL					11. 3			
09/ 01					0. 6			
12/ 01					0. 6			
03/ 02					0. 0			
06/ 02					0. 9			
ANNUAL					2. 1			
09/ 02					0. 4			
12/ 02					0. 6			
03/ 03					1. 8			
06/ 03					2. 1			
ANNUAL					5. 0			
09/ 03					2. 4			
12/ 03					0. 6			
03/ 04					1. 0			
06/ 04					2. 9			
ANNUAL					7. 0			
09/ 04					0. 2			
12/ 04					2. 4			
03/ 05					4. 4			
06/ 05					4. 2			
ANNUAL					11. 6			
HISTORICAL CUMULATIVE					126. 5			
ANNUAL EQUIVALENT					8. 5			

VERMONT MUNICIPAL EMPLOYEES

PERFORMANCE HISTORY

SEIX CORE

<u>QUARTER ENDING</u>	<u>TOTAL FUND</u>	<u>ALLOC INDEX</u>	<u>EQUITY SEGMENT</u>	<u>S&P 500 INDEX</u>	<u>BOND SEGMENT</u>	<u>LEHMN AGG INDX</u>	<u>CASH SEGMENT</u>	<u>91-DAY T-BILL</u>
09/ 95								
12/ 95								
03/ 96								
06/ 96								
ANNUAL								
09/ 96								
12/ 96								
03/ 97								
06/ 97								
ANNUAL								
09/ 97								
12/ 97								
03/ 98								
06/ 98								
ANNUAL								
09/ 98								
12/ 98								
03/ 99								
06/ 99								
ANNUAL								
09/ 99								
12/ 99								
03/ 00								
06/ 00	1.8	1.7			1.8	1.7		
ANNUAL								

VERMONT MUNICIPAL EMPLOYEES

PERFORMANCE HISTORY

SEIX CORE

QUARTER ENDING	TOTAL FUND	ALLOC INDEX	EQUITY SEGMENT	S&P 500 INDEX	BOND SEGMENT	LEHMN AGG INDX	CASH SEGMENT	91-DAY T-BILL
09/ 00	3.3	3.0			3.3	3.0		
12/ 00	4.5	4.2			4.5	4.2		
03/ 01	3.0	3.0			3.0	3.0		
06/ 01	0.6	0.5			0.6	0.6	1.2	1.1
ANNUAL	11.9	11.2			11.9	11.2		
09/ 01	4.6	4.6			4.6	4.6		
12/ 01	-1.2	0.0			-1.2	0.0		
03/ 02	0.1	0.1			0.1	0.1	0.4	0.4
06/ 02	3.0	3.7			3.1	3.7		
ANNUAL	6.5	8.6			6.6	8.6		
09/ 02	2.7	4.6			2.7	4.6		
12/ 02	2.2	1.6			2.2	1.6		
03/ 03	1.7	1.4			1.7	1.4		
06/ 03	2.9	2.5			2.9	2.5		
ANNUAL	9.8	10.4			9.8	10.4		
09/ 03	0.0	-0.1			0.0	-0.1		
12/ 03	0.5	0.3			0.5	0.3		
03/ 04	2.6	2.7			2.6	2.7		
06/ 04	-2.0	-2.4			-2.0	-2.4		
ANNUAL	1.0	0.3			1.0	0.3		
09/ 04	3.5	3.2			3.5	3.2		
12/ 04	0.9	1.0			0.9	1.0		
03/ 05	-0.3	-0.5			-0.3	-0.5		
06/ 05	2.7	3.0			2.7	3.0		
ANNUAL	7.0	6.8			7.0	6.8		
HISTORICAL CUMULATIVE	44.0	45.4			44.2	45.4		
ANNUAL EQUIVALENT	7.2	7.4			7.2	7.4		

VERMONT MUNICIPAL EMPLOYEES

PERFORMANCE HISTORY

SEIX HIGH YIELD

QUARTER ENDING	TOTAL FUND	ALLOC INDEX	EQUITY SEGMENT	S&P 500 INDEX	BOND SEGMENT	LEHMN AGG INDX	CASH SEGMENT	91-DAY T-BILL
09/00								
12/00								
03/01								
06/01								
ANNUAL								
09/01								
12/01								
03/02								
06/02								
ANNUAL								
09/02								
12/02								
03/03								
06/03								
ANNUAL								
09/03	1.1	1.9			1.1	-0.1		
12/03	4.5	6.0			4.5	0.3		
03/04	2.3	2.0			2.3	2.7		
06/04	-1.5	-0.9			-1.5	-2.4		
ANNUAL	6.4	9.2			6.4	0.3		
09/04	5.0	4.8			5.0	3.2		
12/04	3.0	3.8			3.0	1.0		
03/05	-1.5	-1.2			-1.5	-0.5		
06/05	2.8	2.6			2.8	3.0		
ANNUAL	9.5	10.1			9.5	6.8		
HISTORICAL CUMULATIVE	16.5	20.2			16.5	7.1		
ANNUAL EQUIVALENT	7.9	9.7			7.9	3.5		

VERMONT MUNICIPAL EMPLOYEES

PERFORMANCE HISTORY

ALTERNATIVE INVESTMENTS

QUARTER ENDING	TOTAL FUND	ALLOC INDEX	EQUITY SEGMENT	S&P 500 INDEX	BOND SEGMENT	LEHMN AGG INDX	CASH SEGMENT	91-DAY T-BILL
09/ 95	- 5. 1	11. 8						
12/ 95	0. 0	0. 8						
03/ 96	7. 6	4. 7						
06/ 96	3. 1	7. 6						
ANNUAL	5. 2	27. 0						
09/ 96	- 1. 3	3. 5						
12/ 96	0. 0	5. 2						
03/ 97	- 1. 3	- 5. 4						
06/ 97	- 2. 0	18. 0						
ANNUAL	- 2. 0	21. 7						
09/ 97	1. 6	16. 9						
12/ 97	- 1. 0	- 6. 8						
03/ 98	0. 0	16. 9						
06/ 98	0. 0	3. 2						
ANNUAL	0. 7	31. 4						
09/ 98	0. 0	- 10. 6						
12/ 98	0. 0	29. 5						
03/ 99	0. 0	12. 3						
06/ 99	11. 2	9. 1						
ANNUAL	11. 2	41. 8						
09/ 99	0. 0	2. 2						
12/ 99	0. 0	48. 2						
03/ 00	0. 0	12. 4						
06/ 00	53. 7	- 13. 3						
ANNUAL	53. 8	47. 6						

VERMONT MUNICIPAL EMPLOYEES

PERFORMANCE HISTORY

ALTERNATIVE INVESTMENTS

<u>QUARTER ENDING</u>	<u>INT'L C/S</u>	<u>INT'L BOND</u>	<u>CONV</u>	<u>MORT</u>	<u>REAL ESTATE</u>	<u>SV ASSETS</u>	<u>PRVT INVEST</u>	<u>MISC</u>
09/ 95							- 5. 1	
12/ 95							0. 0	
03/ 96							7. 6	
06/ 96							3. 1	
ANNUAL							5. 2	
09/ 96							- 1. 3	
12/ 96							0. 0	
03/ 97							1. 3	
06/ 97							- 2. 0	
ANNUAL							- 2. 0	
09/ 97							1. 6	
12/ 97							- 1. 0	
03/ 98							0. 0	
06/ 98							0. 0	
ANNUAL							0. 7	
09/ 98							0. 0	
12/ 98							0. 0	
03/ 99							0. 0	
06/ 99							11. 2	
ANNUAL							11. 2	
09/ 99							0. 0	
12/ 99							0. 0	
03/ 00							0. 0	
06/ 00							53. 7	
ANNUAL							53. 8	

VERMONT MUNICIPAL EMPLOYEES

PERFORMANCE HISTORY

ALTERNATIVE INVESTMENTS

QUARTER ENDING	TOTAL FUND	ALLOC INDEX	EQUITY SEGMENT	S&P 500 INDEX	BOND SEGMENT	LEHMN AGG INDX	CASH SEGMENT	91-DAY T-BILL
09/00	0.0	-7.4						
12/00	0.0	-32.7						
03/01	1.9	-25.1						
06/01	5.7	17.1					1.1	1.1
ANNUAL	7.8	-45.4						
09/01	0.1	-28.8					1.0	1.1
12/01	0.0	28.0					0.7	0.6
03/02	0.0	-5.0					0.5	0.4
06/02	-20.7	-19.2					0.5	0.5
ANNUAL	-20.6	-29.9					2.6	2.6
09/02	0.0	-18.3					0.3	0.5
12/02	0.0	12.9					0.5	0.4
03/03	0.0	0.4					0.3	0.3
06/03	-6.6	19.1					0.2	0.3
ANNUAL	-6.5	10.3					1.4	1.5
09/03	0.0	9.2					0.3	0.2
12/03	0.0	11.0					0.2	0.3
03/04	0.0	-0.4					0.4	0.2
06/04	0.0	2.5					0.2	0.2
ANNUAL	0.1	23.7					1.1	1.0
09/04	0.0	-6.6					0.3	0.4
12/04	-18.7	13.0					0.3	0.5
03/05	0.1	-6.3					0.5	0.6
06/05	-14.6	2.2					0.7	0.7
ANNUAL	-30.5	1.1					1.9	2.2
HISTORICAL CUMULATIVE	-1.1	124.4					8.3	8.7
ANNUAL EQUIVALENT	-0.1	8.4					1.9	2.0

VERMONT MUNICIPAL EMPLOYEES

PERFORMANCE HISTORY

ALTERNATIVE INVESTMENTS

<u>QUARTER ENDING</u>	<u>INT'L C/S</u>	<u>INT'L BOND</u>	<u>CONV</u>	<u>MORT</u>	<u>REAL ESTATE</u>	<u>SV ASSETS</u>	<u>PRVT INVEST</u>	<u>MISC</u>
09/ 00							0. 0	
12/ 00							0. 0	
03/ 01							1. 9	
06/ 01							5. 9	
ANNUAL							8. 0	
09/ 01							0. 0	
12/ 01							0. 0	
03/ 02							0. 0	
06/ 02							- 22. 2	
ANNUAL							- 22. 2	
09/ 02							0. 0	
12/ 02							0. 0	
03/ 03							0. 0	
06/ 03							- 7. 2	
ANNUAL							- 7. 2	
09/ 03							0. 0	
12/ 03							0. 0	
03/ 04							0. 0	
06/ 04							0. 0	
ANNUAL							0. 0	
09/ 04							0. 0	
12/ 04							- 22. 7	
03/ 05							0. 0	
06/ 05							- 18. 8	
ANNUAL							- 37. 3	
HISTORICAL CUMULATIVE							- 13. 1	
ANNUAL EQUIVALENT							- 1. 4	

VERMONT MUNICIPAL EMPLOYEES

PERFORMANCE HISTORY

VERMONT INVESTMENTS

QUARTER ENDING	TOTAL FUND	ALLOC INDEX	EQUITY SEGMENT	S&P 500 INDEX	BOND SEGMENT	LEHMN AGG INDX	CASH SEGMENT	91-DAY T-BILL
09/ 95	1. 7	1. 4						
12/ 95	2. 0	1. 5						
03/ 96	0. 0	1. 2						
06/ 96	0. 9	1. 3						
ANNUAL	4. 7	5. 5						
09/ 96	1. 2	1. 4						
12/ 96	1. 6	1. 3						
03/ 97	0. 6	1. 3						
06/ 97	1. 0	1. 4						
ANNUAL	4. 6	5. 4						
09/ 97	2. 0	1. 3						
12/ 97	0. 5	1. 3						
03/ 98	2. 0	1. 3						
06/ 98	1. 0	1. 3						
ANNUAL	5. 7	5. 3						
09/ 98	1. 9	1. 4						
12/ 98	1. 7	1. 1						
03/ 99	1. 0	1. 1						
06/ 99	- 0. 4	1. 2						
ANNUAL	4. 3	4. 9						
09/ 99	1. 2	1. 3						
12/ 99	1. 1	1. 2						
03/ 00	1. 3	1. 4						
06/ 00	1. 4	1. 5						
ANNUAL	5. 1	5. 6						

VERMONT MUNICIPAL EMPLOYEES

PERFORMANCE HISTORY

VERMONT INVESTMENTS

QUARTER ENDING	TOTAL FUND	ALLOC INDEX	EQUITY SEGMENT	S&P 500 INDEX	BOND SEGMENT	LEHMN AGG INDX	CASH SEGMENT	91-DAY T-BILL
09/00	1.9	1.5						
12/00	2.1	1.6						
03/01	2.6	2.0						
06/01	1.1	0.3			1.5	0.6	1.1	1.1
ANNUAL	8.0	5.6						
09/01	1.3	1.7			4.6	4.6	0.7	1.1
12/01	0.4	0.5			-0.4	0.0	0.5	0.6
03/02	0.6	0.4			2.0	0.1	0.3	0.4
06/02	0.9	0.9			4.0	3.7	0.5	0.5
ANNUAL	3.1	3.6			10.5	8.6	2.0	2.6
09/02	1.8	1.3			6.9	4.6	0.5	0.5
12/02	0.1	0.5			-0.4	1.6	0.3	0.4
03/03	-0.8	0.6			-6.4	1.4	0.3	0.3
06/03	0.6	0.3			1.1	2.5	0.2	0.3
ANNUAL	1.6	2.7			0.8	10.4	1.3	1.5
09/03	1.3	-0.1			2.1	-0.1	0.2	0.2
12/03	0.5	0.0			3.0	0.3	0.2	0.3
03/04	0.4	0.4			1.5	2.7	0.3	0.2
06/04	-0.3	0.1			-1.7	-2.4	0.1	0.2
ANNUAL	1.7	0.4			4.9	0.3	0.8	1.0
09/04	0.8	0.9			2.2	3.2	0.3	0.4
12/04	1.1	0.6			1.3	1.0	1.0	0.5
03/05	1.8	0.6			1.1	-0.5	2.0	0.6
06/05	0.5	1.2			-1.6	3.0	0.8	0.7
ANNUAL	4.3	3.3			3.0	6.8	4.1	2.2
HISTORICAL CUMULATIVE	52.3	51.2			22.2	29.2	9.5	8.7
ANNUAL EQUIVALENT	4.3	4.2			4.8	6.2	2.2	2.0

VERMONT MUNICIPAL EMPLOYEES

ASSET ALLOCATION HISTORY

MUNICIPAL SYSTEM COMPOSITE

QUARTER ENDING	TOTAL VALUE	COMMON STOCK	INT'L C/S	BOND	INT'L BOND	CONV	CASH EQUIV	MORT	REAL ESTATE	SV ASSETS	PRVT INVEST	MISC
09/95	\$77,000,000											100.0
12/95	\$80,900,000											100.0
03/96	\$80,800,000											100.0
06/96	\$86,000,000	0.0		0.0					0.0		0.0	100.0
ANNUAL AVERAGE	\$81,925,000	0.0	0.0	0.0	0.0	0.0	0.0	0.0	0.0	0.0	0.0	100.0
09/96	\$0											
12/96	\$96,900,000	49.9	5.2	27.6	9.5		2.8		4.1		0.0	1.0
03/97	\$100,800,000	47.7	4.8	27.2	8.7		6.7		4.0		0.0	1.0
06/97	\$100,000,000	52.0	5.0	26.0	8.0		2.0		6.0		0.0	1.0
ANNUAL AVERAGE	\$74,425,000	37.4	3.7	20.2	6.6	0.0	2.9	0.0	3.5	0.0	0.0	0.8
09/97	\$100,000,000	53.0	5.0	25.0	8.0		2.0		6.0		0.0	1.0
12/97	\$100,000,000	48.0	6.0	28.0	7.0		4.0		7.0		0.0	
03/98	\$123,341,000	57.0	4.1	5.2	7.0		20.8		5.4		0.5	
06/98	\$134,807,000	52.4	4.0	26.8	6.8		4.5		5.2		0.3	
ANNUAL AVERAGE	\$116,037,000	52.6	4.8	21.3	7.2	0.0	7.8	0.0	5.9	0.0	0.2	0.3
09/98	\$126,294,000	44.5	14.9	28.9			5.4		5.7		0.6	
12/98	\$146,172,000	47.0	15.2	28.7			1.8		6.9		0.4	
03/99	\$151,042,000	48.2	14.7	27.4			2.4		6.9		0.4	
06/99	\$157,985,000	45.3	14.6	29.2			3.7		6.3		0.9	
ANNUAL AVERAGE	\$145,373,250	46.3	14.9	28.6	0.0	0.0	3.3	0.0	6.5	0.0	0.6	0.0
09/99	\$152,699,000	43.3	15.5	30.4			3.6		6.8		0.4	
12/99	\$167,650,000	43.5	16.2	27.5			6.0		6.3		0.5	
03/00	\$163,188,000	43.6	15.3	34.2					6.5		0.4	
06/00	\$171,940,000	41.6	15.0	36.5					6.4		0.5	
ANNUAL AVERAGE	\$165,369,250	43.0	15.5	32.2	0.0	0.0	2.4	0.0	6.5	0.0	0.4	0.0

VERMONT MUNICIPAL EMPLOYEES

ASSET ALLOCATION HISTORY

MUNICIPAL SYSTEM COMPOSITE

QUARTER ENDING	TOTAL VALUE	COMMON STOCK	INT'L C/S	BOND	INT'L BOND	CONV	CASH EQUIV	MORT	REAL ESTATE	SV ASSETS	PRVT INVEST	MISC
09/00	\$ 168,240,000	44.6	14.5	30.7			2.6		6.9		0.7	
12/00	\$ 170,641,000	42.7	14.6	30.1			4.9		7.1		0.6	
03/01	\$ 163,148,377	40.4	19.0	32.4			0.0		7.6		0.6	
06/01	\$ 172,114,864	40.8	18.4	31.0			1.9		7.3		0.6	
ANNUAL AVERAGE	\$ 168,536,060	42.1	16.6	31.1	0.0	0.0	2.3	0.0	7.2	0.0	0.6	0.0
09/01	\$ 162,816,654	37.6	17.3	34.3			2.4		7.8		0.6	
12/01	\$ 173,055,437	40.3	17.5	31.9			2.4		7.4		0.6	
03/02	\$ 178,976,642	39.3	17.3	35.9					7.0		0.6	
06/02	\$ 171,715,255	36.9	19.3	33.1			2.8		7.4		0.5	
ANNUAL AVERAGE	\$ 171,140,997	38.5	17.8	33.8	0.0	0.0	1.9	0.0	7.4	0.0	0.6	0.0
09/02	\$ 156,188,036	34.9	18.8	32.2			5.4		8.2		0.5	
12/02	\$ 163,064,127	39.1	19.4	31.2			2.1		7.8		0.5	
03/03	\$ 163,152,409	43.1	14.0	32.9			1.7		7.8		0.5	
06/03	\$ 183,321,463	46.3	15.3	30.8			0.1		7.2		0.4	
ANNUAL AVERAGE	\$ 168,431,509	40.8	16.9	31.8	0.0	0.0	2.3	0.0	7.8	0.0	0.5	0.0
09/03	\$ 192,137,407	46.6	15.7	29.8			0.4		7.1		0.4	
12/03	\$ 210,211,569	44.9	16.7	29.9			1.6		6.5		0.4	
03/04	\$ 218,193,787	44.3	16.6	29.6			2.9		6.3		0.3	
06/04	\$ 220,725,831	45.1	16.3	31.3			0.5		6.4		0.3	
ANNUAL AVERAGE	\$ 210,317,149	45.2	16.3	30.1	0.0	0.0	1.4	0.0	6.6	0.0	0.4	0.0
09/04	\$ 221,739,594	43.4	16.5	33.0			0.3		6.4		0.3	
12/04	\$ 233,747,213	45.0	17.5	31.1			0.2		6.0		0.2	
03/05	\$ 233,815,040	42.7	16.6	32.8			0.5		7.1		0.2	
06/05	\$ 243,738,518	43.6	16.0	32.7			0.3		7.2		0.2	
ANNUAL AVERAGE	\$ 236,510,091	43.7	16.7	32.4	0.0	0.0	0.3	0.0	6.7	0.0	0.3	0.0
OVERALL AVERAGE	\$ 153,806,531	39.0	12.3	26.1	1.4	0.0	2.5	0.0	5.8	0.0	0.4	10.1

VERMONT MUNICIPAL EMPLOYEES

ASSET ALLOCATION HISTORY

DOMESTIC EQUITY COMPOSITE

QUARTER ENDING	TOTAL VALUE	COMMON STOCK	INT'L C/S	BOND	INT'L BOND	CONV	CASH EQUIV	MORT	REAL ESTATE	SV ASSETS	PRVT INVEST	MISC
09/95												
12/95												
03/96												
06/96	\$ 0											
ANNUAL AVERAGE	\$ 0	0.0	0.0	0.0	0.0	0.0	0.0	0.0	0.0	0.0	0.0	0.0
09/96	\$ 0											
12/96	\$ 0											
03/97	\$ 0											
06/97	\$ 0											
ANNUAL AVERAGE	\$ 0	0.0	0.0	0.0	0.0	0.0	0.0	0.0	0.0	0.0	0.0	0.0
09/97	\$ 0											
12/97	\$ 0											
03/98	\$70,256,000	100.0										
06/98	\$67,408,000	100.0										
ANNUAL AVERAGE	\$34,416,000	50.0	0.0	0.0	0.0	0.0	0.0	0.0	0.0	0.0	0.0	0.0
09/98	\$58,000,000	100.0										
12/98	\$68,698,000	100.0										
03/99	\$72,866,000	100.0										
06/99	\$71,308,000	100.0										
ANNUAL AVERAGE	\$67,718,000	100.0	0.0	0.0	0.0	0.0	0.0	0.0	0.0	0.0	0.0	0.0
09/99	\$65,822,000	100.0										
12/99	\$72,977,000	100.0										
03/00	\$74,396,000	100.0										
06/00	\$73,237,000	100.0										
ANNUAL AVERAGE	\$71,608,000	100.0	0.0	0.0	0.0	0.0	0.0	0.0	0.0	0.0	0.0	0.0

VERMONT MUNICIPAL EMPLOYEES

ASSET ALLOCATION HISTORY

DOMESTIC EQUITY COMPOSITE

QUARTER ENDING	TOTAL VALUE	COMMON STOCK	INT'L C/S	BOND	INT'L BOND	CONV	CASH EQUIV	MORT	REAL ESTATE	SV ASSETS	PRVT INVEST	MISC
09/00	\$73,935,000	100.0										
12/00	\$72,423,000	100.0										
03/01	\$65,831,828	100.0										
06/01	\$70,240,677	100.0					0.0					
ANNUAL AVERAGE	\$70,607,626	100.0	0.0	0.0	0.0	0.0	0.0	0.0	0.0	0.0	0.0	0.0
09/01	\$61,386,357	99.8					0.2					
12/01	\$69,815,580	100.0					0.0					
03/02	\$77,452,309	99.9					0.1					
06/02	\$63,908,483	96.1					3.9					
ANNUAL AVERAGE	\$67,140,682	99.0	0.0	0.0	0.0	0.0	1.0	0.0	0.0	0.0	0.0	0.0
09/02	\$61,299,498	88.9					11.1					
12/02	\$64,513,754	100.0					0.0					
03/03	\$72,026,513	100.0										
06/03	\$83,753,952	100.0										
ANNUAL AVERAGE	\$70,898,429	97.2	0.0	0.0	0.0	0.0	2.8	0.0	0.0	0.0	0.0	0.0
09/03	\$89,498,541	100.0										
12/03	\$94,455,722	100.0										
03/04	\$96,733,008	100.0										
06/04	\$99,540,459	100.0										
ANNUAL AVERAGE	\$95,056,933	100.0	0.0	0.0	0.0	0.0	0.0	0.0	0.0	0.0	0.0	0.0
09/04	\$96,296,101	100.0										
12/04	\$107,766,695	100.0										
03/05	\$102,211,676	99.8					0.2					
06/05	\$107,581,762	99.7					0.3					
ANNUAL AVERAGE	\$103,464,059	99.9	0.0	0.0	0.0	0.0	0.1	0.0	0.0	0.0	0.0	0.0
OVERALL AVERAGE	\$62,801,052	80.7	0.0	0.0	0.0	0.0	0.4	0.0	0.0	0.0	0.0	0.0

VERMONT MUNICIPAL EMPLOYEES

ASSET ALLOCATION HISTORY

DELAWARE

QUARTER ENDING	TOTAL VALUE	COMMON STOCK	INT'L C/S	BOND	INT'L BOND	CONV	CASH EQUIV	MORT	REAL ESTATE	SV ASSETS	PRVT INVEST	MISC
09/95	\$18,967,000	100.0										
12/95	\$20,239,000	100.0										
03/96	\$20,315,000	100.0										
06/96	\$21,901,000	100.0										
ANNUAL AVERAGE	\$20,605,500	100.0	0.0	0.0	0.0	0.0	0.0	0.0	0.0	0.0	0.0	0.0
09/96	\$22,773,000	100.0										
12/96	\$24,693,000	100.0										
03/97	\$25,294,000	100.0										
06/97	\$29,267,000	100.0										
ANNUAL AVERAGE	\$25,506,750	100.0	0.0	0.0	0.0	0.0	0.0	0.0	0.0	0.0	0.0	0.0
09/97	\$32,057,000	100.0										
12/97	\$35,888,000	100.0										
03/98	\$36,896,000	100.0										
06/98	\$31,460,000	100.0										
ANNUAL AVERAGE	\$33,325,250	100.0	0.0	0.0	0.0	0.0	0.0	0.0	0.0	0.0	0.0	0.0
09/98	\$27,719,000	100.0										
12/98	\$31,794,000	100.0										
03/99	\$31,985,000	100.0										
06/99	\$27,349,000	100.0										
ANNUAL AVERAGE	\$29,711,750	100.0	0.0	0.0	0.0	0.0	0.0	0.0	0.0	0.0	0.0	0.0
09/99	\$24,719,000	100.0										
12/99	\$25,580,000	100.0										
03/00	\$24,227,000	100.0										
06/00	\$24,252,000	100.0										
ANNUAL AVERAGE	\$24,694,500	100.0	0.0	0.0	0.0	0.0	0.0	0.0	0.0	0.0	0.0	0.0

VERMONT MUNICIPAL EMPLOYEES

ASSET ALLOCATION HISTORY

DELAWARE

QUARTER ENDING	TOTAL VALUE	COMMON STOCK	INT'L C/S	BOND	INT'L BOND	CONV	CASH EQUIV	MORT	REAL ESTATE	SV ASSETS	PRVT INVEST	MISC
09/00	\$26,354,000	100.0										
12/00	\$28,984,000	100.0										
03/01	\$27,843,000	100.0										
06/01	\$28,924,644	99.9					0.1					
ANNUAL AVERAGE	\$28,026,411	100.0	0.0	0.0	0.0	0.0	0.0	0.0	0.0	0.0	0.0	0.0
09/01	\$25,632,004	99.6					0.4					
12/01	\$27,873,588	99.9					0.1					
03/02	\$26,421,666	99.9					0.1					
06/02	\$27,207,577	98.0					2.0					
ANNUAL AVERAGE	\$27,533,709	99.4	0.0	0.0	0.0	0.0	0.6	0.0	0.0	0.0	0.0	0.0
09/02	\$22,136,855	99.8					0.3					
12/02	\$25,908,736	100.0					0.0					
03/03	\$28,934,653	100.0										
06/03	\$33,472,227	100.0										
ANNUAL AVERAGE	\$26,613,118	99.9	0.0	0.0	0.0	0.0	0.1	0.0	0.0	0.0	0.0	0.0
09/03	\$34,328,601	100.0										
12/03	\$37,659,710	100.0										
03/04	\$38,328,861	100.0										
06/04	\$39,060,113	100.0										
ANNUAL AVERAGE	\$37,344,321	100.0	0.0	0.0	0.0	0.0	0.0	0.0	0.0	0.0	0.0	0.0
09/04	\$38,601,324	100.0										
12/04	\$41,975,083	100.0										
03/05	\$41,437,411	99.4					0.6					
06/05	\$41,979,641	99.2					0.8					
ANNUAL AVERAGE	\$40,998,365	99.7	0.0	0.0	0.0	0.0	0.3	0.0	0.0	0.0	0.0	0.0
OVERALL AVERAGE	\$29,435,967	99.9	0.0	0.0	0.0	0.0	0.1	0.0	0.0	0.0	0.0	0.0

VERMONT MUNICIPAL EMPLOYEES

ASSET ALLOCATION HISTORY

ALLIANCE LARGE CAP GROWTH FUND

QUARTER ENDING	TOTAL VALUE	COMMON STOCK	INT'L C/S	BOND	INT'L BOND	CONV	CASH EQUIV	MORT	REAL ESTATE	SV ASSETS	PRVT INVEST	MISC
09/95	\$12,952,000	100.0										
12/95	\$17,889,000	100.0										
03/96	\$17,473,000	100.0										
06/96	\$18,133,000	100.0										
ANNUAL AVERAGE	\$15,361,750	100.0	0.0	0.0	0.0	0.0	0.0	0.0	0.0	0.0	0.0	0.0
09/96	\$18,720,000	100.0										
12/96	\$20,779,000	100.0										
03/97	\$20,525,000	100.0										
06/97	\$24,652,000	100.0										
ANNUAL AVERAGE	\$21,169,000	100.0	0.0	0.0	0.0	0.0	0.0	0.0	0.0	0.0	0.0	0.0
09/97	\$27,935,000	100.0										
12/97	\$27,433,000	100.0										
03/98	\$33,360,000	100.0										
06/98	\$33,948,000	100.0										
ANNUAL AVERAGE	\$31,169,000	100.0	0.0	0.0	0.0	0.0	0.0	0.0	0.0	0.0	0.0	0.0
09/98	\$27,952,000	100.0										
12/98	\$36,903,000	100.0										
03/99	\$40,881,000	100.0										
06/99	\$29,988,000	100.0										
ANNUAL AVERAGE	\$33,931,000	100.0	0.0	0.0	0.0	0.0	0.0	0.0	0.0	0.0	0.0	0.0
09/99	\$28,421,000	100.0										
12/99	\$34,587,000	100.0										
03/00	\$33,857,000	100.0										
06/00	\$33,650,000	100.0										
ANNUAL AVERAGE	\$33,878,750	100.0	0.0	0.0	0.0	0.0	0.0	0.0	0.0	0.0	0.0	0.0

VERMONT MUNICIPAL EMPLOYEES

ASSET ALLOCATION HISTORY

ALLIANCE LARGE CAP GROWTH FUND

QUARTER ENDING	TOTAL VALUE	COMMON STOCK	INT'L C/S	BOND	INT'L BOND	CONV	CASH EQUIV	MORT	REAL ESTATE	SV ASSETS	PRVT INVEST	MISC
09/00	\$33,578,000	100.0										
12/00	\$33,593,000	100.0										
03/01	\$33,603,000	100.0										
06/01	\$23,081,654	100.0					0.0					
ANNUAL AVERAGE	\$27,713,914	100.0	0.0	0.0	0.0	0.0	0.0	0.0	0.0	0.0	0.0	0.0
09/01	\$21,192,830	100.0					0.0					
12/01	\$24,414,973	100.0					0.0					
03/02	\$27,284,861	100.0					0.0					
06/02	\$21,688,804	90.7					9.3					
ANNUAL AVERAGE	\$22,645,367	97.7	0.0	0.0	0.0	0.0	2.3	0.0	0.0	0.0	0.0	0.0
09/02	\$23,499,088	71.2					28.8					
12/02	\$24,168,257	100.0										
03/03	\$28,486,854	100.0										
06/03	\$2,107,299	100.0										
ANNUAL AVERAGE	\$27,065,375	92.8	0.0	0.0	0.0	0.0	7.2	0.0	0.0	0.0	0.0	0.0
09/03	\$33,368,796	100.0										
12/03	\$34,121,301	100.0										
03/04	\$34,670,760	100.0										
06/04	\$36,309,751	100.0										
ANNUAL AVERAGE	\$34,617,652	100.0	0.0	0.0	0.0	0.0	0.0	0.0	0.0	0.0	0.0	0.0
09/04	\$34,225,443	100.0										
12/04	\$39,568,923	100.0										
03/05	\$37,115,764	100.0										
06/05	\$39,504,571	100.0										
ANNUAL AVERAGE	\$37,603,675	100.0	0.0	0.0	0.0	0.0	0.0	0.0	0.0	0.0	0.0	0.0
OVERALL AVERAGE	\$28,515,548	99.0	0.0	0.0	0.0	0.0	1.0	0.0	0.0	0.0	0.0	0.0

VERMONT MUNICIPAL EMPLOYEES

ASSET ALLOCATION HISTORY

LAZARD SMALL CAP FUND

QUARTER ENDING	TOTAL VALUE	COMMON STOCK	INT'L C/S	BOND	INT'L BOND	CONV	CASH EQUIV	MORT	REAL ESTATE	SV ASSETS	PRVT INVEST	MISC
09/95 12/95 03/96 06/96												
ANNUAL AVERAGE	\$0	0.0	0.0	0.0	0.0	0.0	0.0	0.0	0.0	0.0	0.0	0.0
09/96 12/96 03/97 06/97												
ANNUAL AVERAGE	\$0	0.0	0.0	0.0	0.0	0.0	0.0	0.0	0.0	0.0	0.0	0.0
09/97 12/97 03/98 06/98												
ANNUAL AVERAGE	\$0	0.0	0.0	0.0	0.0	0.0	0.0	0.0	0.0	0.0	0.0	0.0
09/98 12/98 03/99 06/99	\$13,970,000	100.0										
ANNUAL AVERAGE	\$13,970,000	100.0	0.0	0.0	0.0	0.0	0.0	0.0	0.0	0.0	0.0	0.0
09/99 12/99 03/00 06/00	\$12,682,000 \$12,810,000 \$13,312,000 \$13,335,000	100.0 100.0 100.0 100.0										
ANNUAL AVERAGE	\$13,034,750	100.0	0.0	0.0	0.0	0.0	0.0	0.0	0.0	0.0	0.0	0.0

VERMONT MUNICIPAL EMPLOYEES

ASSET ALLOCATION HISTORY

LAZARD SMALL CAP FUND

QUARTER ENDING	TOTAL VALUE	COMMON STOCK	INT'L C/S	BOND	INT'L BOND	CONV	CASH EQUIV	MORT	REAL ESTATE	SV ASSETS	PRVT INVEST	MISC
09/00	\$14,003,000	100.0										
12/00	\$14,846,000	100.0										
03/01	\$14,385,828	100.0										
06/01	\$16,234,379	100.0										
ANNUAL AVERAGE	\$14,867,302	100.0	0.0	0.0	0.0	0.0	0.0	0.0	0.0	0.0	0.0	0.0
09/01	\$14,561,523	100.0										
12/01	\$17,527,019	100.0										
03/02	\$19,745,782	100.0										
06/02	\$17,012,102	100.0										
ANNUAL AVERAGE	\$16,961,607	100.0	0.0	0.0	0.0	0.0	0.0	0.0	0.0	0.0	0.0	0.0
09/02	\$15,663,555	100.0										
12/02	\$16,436,761	100.0										
03/03	\$18,605,006	100.0										
06/03	\$20,174,426	100.0										
ANNUAL AVERAGE	\$17,219,937	100.0	0.0	0.0	0.0	0.0	0.0	0.0	0.0	0.0	0.0	0.0
09/03	\$21,801,144	100.0										
12/03	\$22,674,711	100.0										
03/04	\$23,733,387	100.0										
06/04	\$24,170,595	100.0										
ANNUAL AVERAGE	\$23,094,959	100.0	0.0	0.0	0.0	0.0	0.0	0.0	0.0	0.0	0.0	0.0
09/04	\$23,469,334	100.0										
12/04	\$26,222,689	100.0										
03/05	\$23,658,501	100.0										
06/05	\$26,097,550	100.0										
ANNUAL AVERAGE	\$24,862,019	100.0	0.0	0.0	0.0	0.0	0.0	0.0	0.0	0.0	0.0	0.0
OVERALL AVERAGE	\$18,165,292	100.0	0.0	0.0	0.0	0.0	0.0	0.0	0.0	0.0	0.0	0.0

VERMONT MUNICIPAL EMPLOYEES

ASSET ALLOCATION HISTORY

BRINSON - UBS

QUARTER ENDING	TOTAL VALUE	COMMON STOCK	INT'L C/S	BOND	INT'L BOND	CONV	CASH EQUIV	MORT	REAL ESTATE	SV ASSETS	PRVT INVEST	MISC
09/95	\$16,086,000		100.0									
12/95	\$17,023,000		100.0									
03/96	\$19,474,000		100.0									
06/96	\$19,977,000		100.0									
ANNUAL AVERAGE	\$18,140,000	0.0	100.0	0.0	0.0	0.0	0.0	0.0	0.0	0.0	0.0	0.0
09/96	\$20,513,000		100.0									
12/96	\$21,422,000		100.0									
03/97	\$21,111,000		100.0									
06/97	\$22,605,000		100.0									
ANNUAL AVERAGE	\$21,412,750	0.0	100.0	0.0	0.0	0.0	0.0	0.0	0.0	0.0	0.0	0.0
09/97	\$23,144,000		100.0									
12/97	\$22,817,000		100.0									
03/98	\$24,028,000		100.0									
06/98	\$24,235,000		100.0									
ANNUAL AVERAGE	\$23,556,000	0.0	100.0	0.0	0.0	0.0	0.0	0.0	0.0	0.0	0.0	0.0
09/98	\$24,188,000		100.0									
12/98	\$22,289,000		100.0									
03/99	\$22,269,000		100.0									
06/99	\$23,069,000		100.0									
ANNUAL AVERAGE	\$22,953,750	0.0	100.0	0.0	0.0	0.0	0.0	0.0	0.0	0.0	0.0	0.0
09/99	\$23,660,000		100.0									
12/99	\$27,156,000		100.0									
03/00	\$26,222,000		100.0									
06/00	\$26,395,000		100.0									
ANNUAL AVERAGE	\$25,858,250	0.0	100.0	0.0	0.0	0.0	0.0	0.0	0.0	0.0	0.0	0.0

VERMONT MUNICIPAL EMPLOYEES

ASSET ALLOCATION HISTORY

BRINSON - UBS

QUARTER ENDING	TOTAL VALUE	COMMON STOCK	INT'L C/S	BOND	INT'L BOND	CONV	CASH EQUIV	MORT	REAL ESTATE	SV ASSETS	PRVT INVEST	MISC
09/00	\$24,448,000		100.0									
12/00	\$24,917,000		100.0									
03/01	\$25,994,000		100.0									
06/01	\$31,623,739		100.0									
ANNUAL AVERAGE	\$27,995,685	0.0	100.0	0.0	0.0	0.0	0.0	0.0	0.0	0.0	0.0	0.0
09/01	\$28,143,429		100.0				0.0					
12/01	\$30,301,064		100.0				0.0					
03/02	\$31,307,322		100.0				0.0					
06/02	\$33,162,921		100.0				0.0					
ANNUAL AVERAGE	\$30,728,684	0.0	100.0	0.0	0.0	0.0	0.0	0.0	0.0	0.0	0.0	0.0
09/02	\$29,362,509		100.0				0.0					
12/02	\$31,683,528		100.0				0.0					
03/03	\$31,481,991		100.0				0.0					
06/03	\$28,264,951		100.0				0.0					
ANNUAL AVERAGE	\$28,273,245	0.0	100.0	0.0	0.0	0.0	0.0	0.0	0.0	0.0	0.0	0.0
09/03	\$30,220,275		100.0				0.0					
12/03	\$35,151,536		100.0				0.0					
03/04	\$38,136,452		100.0				0.0					
06/04	\$36,072,855		100.0				0.0					
ANNUAL AVERAGE	\$34,395,280	0.0	100.0	0.0	0.0	0.0	0.0	0.0	0.0	0.0	0.0	0.0
09/04	\$36,639,208		100.0				0.0					
12/04	\$41,888,190		100.0				0.0					
03/05	\$37,723,228		100.0				0.0					
06/05	\$39,348,285		100.0				0.0					
ANNUAL AVERAGE	\$39,399,728	0.0	100.0	0.0	0.0	0.0	0.0	0.0	0.0	0.0	0.0	0.0
OVERALL AVERAGE	\$27,271,337	0.0	100.0	0.0	0.0	0.0	0.0	0.0	0.0	0.0	0.0	0.0

VERMONT MUNICIPAL EMPLOYEES

ASSET ALLOCATION HISTORY

MET LIFE / SSR TOWER FUND

QUARTER ENDING	TOTAL VALUE	COMMON STOCK	INT'L C/S	BOND	INT'L BOND	CONV	CASH EQUIV	MORT	REAL ESTATE	SV ASSETS	PRVT INVEST	MISC
09/95	\$1,886,000								100.0			
12/95	\$1,927,000								100.0			
03/96	\$1,856,000								100.0			
06/96	\$739,000								100.0			
ANNUAL AVERAGE	\$1,602,000	0.0	0.0	0.0	0.0	0.0	0.0	0.0	100.0	0.0	0.0	0.0
09/96	\$739,000								100.0			
12/96	\$749,000								100.0			
03/97	\$1,045,000								100.0			
06/97	\$6,572,000								100.0			
ANNUAL AVERAGE	\$3,026,250	0.0	0.0	0.0	0.0	0.0	0.0	0.0	100.0	0.0	0.0	0.0
09/97	\$6,652,000								100.0			
12/97	\$6,838,000								100.0			
03/98	\$7,020,000								100.0			
06/98	\$7,020,000								100.0			
ANNUAL AVERAGE	\$6,882,500	0.0	0.0	0.0	0.0	0.0	0.0	0.0	100.0	0.0	0.0	0.0
09/98	\$7,248,000								100.0			
12/98	\$10,085,000								100.0			
03/99	\$10,389,000								100.0			
06/99	\$10,024,000								100.0			
ANNUAL AVERAGE	\$9,436,500	0.0	0.0	0.0	0.0	0.0	0.0	0.0	100.0	0.0	0.0	0.0
09/99	\$10,340,000								100.0			
12/99	\$10,598,000								100.0			
03/00	\$11,208,000								100.0			
06/00	\$11,355,000								100.0			
ANNUAL AVERAGE	\$10,875,250	0.0	0.0	0.0	0.0	0.0	0.0	0.0	100.0	0.0	0.0	0.0

VERMONT MUNICIPAL EMPLOYEES

ASSET ALLOCATION HISTORY

MET LIFE / SSR TOWER FUND

QUARTER ENDING	TOTAL VALUE	COMMON STOCK	INT'L C/S	BOND	INT'L BOND	CONV	CASH EQUIV	MORT	REAL ESTATE	SV ASSETS	PRVT INVEST	MISC
09/00	\$11,672,000								100.0			
12/00	\$12,181,000								100.0			
03/01	\$12,403,000								100.0			
06/01	\$12,628,498								100.0			
ANNUAL AVERAGE	\$12,221,125	0.0	0.0	0.0	0.0	0.0	0.0	0.0	100.0	0.0	0.0	0.0
09/01	\$12,698,462								100.0			
12/01	\$12,739,788								100.0			
03/02	\$12,705,292								100.0			
06/02	\$12,782,391								100.0			
ANNUAL AVERAGE	\$12,731,483	0.0	0.0	0.0	0.0	0.0	0.0	0.0	100.0	0.0	0.0	0.0
09/02	\$12,798,823								100.0			
12/02	\$12,889,065								100.0			
03/03	\$13,086,370								100.0			
06/03	\$13,334,203								100.0			
ANNUAL AVERAGE	\$13,027,115	0.0	0.0	0.0	0.0	0.0	0.0	0.0	100.0	0.0	0.0	0.0
09/03	\$13,620,576								100.0			
12/03	\$13,660,495								100.0			
03/04	\$13,766,796								100.0			
06/04	\$14,125,010								100.0			
ANNUAL AVERAGE	\$13,793,219	0.0	0.0	0.0	0.0	0.0	0.0	0.0	100.0	0.0	0.0	0.0
09/04	\$14,105,906								100.0			
12/04	\$14,404,492								100.0			
03/05	\$17,002,951								100.0			
06/05	\$17,667,544								100.0			
ANNUAL AVERAGE	\$15,795,223	0.0	0.0	0.0	0.0	0.0	0.0	0.0	100.0	0.0	0.0	0.0
OVERALL AVERAGE	\$9,939,067	0.0	0.0	0.0	0.0	0.0	0.0	0.0	100.0	0.0	0.0	0.0

VERMONT MUNICIPAL EMPLOYEES

ASSET ALLOCATION HISTORY

SEIX CORE

QUARTER ENDING	TOTAL VALUE	COMMON STOCK	INT'L C/S	BOND	INT'L BOND	CONV	CASH EQUIV	MORT	REAL ESTATE	SV ASSETS	PRVT INVEST	MISC
09/95 12/95 03/96 06/96												
ANNUAL AVERAGE	\$0	0.0	0.0	0.0	0.0	0.0	0.0	0.0	0.0	0.0	0.0	0.0
09/96 12/96 03/97 06/97												
ANNUAL AVERAGE	\$0	0.0	0.0	0.0	0.0	0.0	0.0	0.0	0.0	0.0	0.0	0.0
09/97 12/97 03/98 06/98												
ANNUAL AVERAGE	\$0	0.0	0.0	0.0	0.0	0.0	0.0	0.0	0.0	0.0	0.0	0.0
09/98 12/98 03/99 06/99												
ANNUAL AVERAGE	\$0	0.0	0.0	0.0	0.0	0.0	0.0	0.0	0.0	0.0	0.0	0.0
09/99 12/99 03/00 06/00	\$52,397,000 \$53,366,000			100.0 100.0								
ANNUAL AVERAGE	\$52,881,500	0.0	0.0	100.0	0.0	0.0	0.0	0.0	0.0	0.0	0.0	0.0

VERMONT MUNICIPAL EMPLOYEES

ASSET ALLOCATION HISTORY

SEIX CORE

QUARTER ENDING	TOTAL VALUE	COMMON STOCK	INT'L C/S	BOND	INT'L BOND	CONV	CASH EQUIV	MORT	REAL ESTATE	SV ASSETS	PRVT INVEST	MISC
09/00	\$55,106,000			100.0								
12/00	\$57,610,000			100.0								
03/01	\$52,337,307			100.0								
06/01	\$52,723,091			100.0			0.0					
ANNUAL AVERAGE	\$54,444,100	0.0	0.0	100.0	0.0	0.0	0.0	0.0	0.0	0.0	0.0	0.0
09/01	\$55,135,870			100.0								
12/01	\$54,462,538			100.0								
03/02	\$54,539,509			100.0								
06/02	\$56,149,808			100.0								
ANNUAL AVERAGE	\$55,071,931	0.0	0.0	100.0	0.0	0.0	0.0	0.0	0.0	0.0	0.0	0.0
09/02	\$49,646,988			100.0								
12/02	\$50,739,841			100.0								
03/03	\$50,640,083			100.0								
06/03	\$47,733,386			100.0								
ANNUAL AVERAGE	\$50,690,075	0.0	0.0	100.0	0.0	0.0	0.0	0.0	0.0	0.0	0.0	0.0
09/03	\$47,723,141			100.0								
12/03	\$51,966,772			100.0								
03/04	\$53,341,763			100.0								
06/04	\$56,213,956			100.0								
ANNUAL AVERAGE	\$52,811,408	0.0	0.0	100.0	0.0	0.0	0.0	0.0	0.0	0.0	0.0	0.0
09/04	\$61,796,577			100.0								
12/04	\$62,842,119			100.0								
03/05	\$65,697,950			100.0								
06/05	\$67,471,617			100.0								
ANNUAL AVERAGE	\$64,452,066	0.0	0.0	100.0	0.0	0.0	0.0	0.0	0.0	0.0	0.0	0.0
OVERALL AVERAGE	\$55,256,423	0.0	0.0	100.0	0.0	0.0	0.0	0.0	0.0	0.0	0.0	0.0

VERMONT MUNICIPAL EMPLOYEES

ASSET ALLOCATION HISTORY

SEIX HIGH YIELD

QUARTER ENDING	TOTAL VALUE	COMMON STOCK	INT'L C/S	BOND	INT'L BOND	CONV	CASH EQUIV	MORT	REAL ESTATE	SV ASSETS	PRVT INVEST	MISC
09/00												
12/00												
03/01												
06/01												
ANNUAL AVERAGE	\$0	0.0	0.0	0.0	0.0	0.0	0.0	0.0	0.0	0.0	0.0	0.0
09/01												
12/01												
03/02												
06/02												
ANNUAL AVERAGE	\$0	0.0	0.0	0.0	0.0	0.0	0.0	0.0	0.0	0.0	0.0	0.0
09/02												
12/02												
03/03												
06/03	\$9,054,927			100.0								
ANNUAL AVERAGE	\$9,054,927	0.0	0.0	100.0	0.0	0.0	0.0	0.0	0.0	0.0	0.0	0.0
09/03	\$9,137,381			100.0								
12/03	\$10,578,524			100.0								
03/04	\$10,804,414			100.0								
06/04	\$10,631,852			100.0								
ANNUAL AVERAGE	\$10,288,043	0.0	0.0	100.0	0.0	0.0	0.0	0.0	0.0	0.0	0.0	0.0
09/04	\$11,144,985			100.0			0.0					
12/04	\$11,461,056			100.0								
03/05	\$12,268,684			100.0								
06/05	\$12,598,449			100.0								
ANNUAL AVERAGE	\$11,868,294	0.0	0.0	100.0	0.0	0.0	0.0	0.0	0.0	0.0	0.0	0.0
OVERALL AVERAGE	\$10,853,364	0.0	0.0	100.0	0.0	0.0	0.0	0.0	0.0	0.0	0.0	0.0

VERMONT MUNICIPAL EMPLOYEES

ASSET ALLOCATION HISTORY

ALTERNATIVE INVESTMENTS

QUARTER ENDING	TOTAL VALUE	COMMON STOCK	INT'L C/S	BOND	INT'L BOND	CONV	CASH EQUIV	MORT	REAL ESTATE	SV ASSETS	PRVT INVEST	MISC
09/95	\$570,000										100.0	
12/95	\$570,000										100.0	
03/96	\$613,000										100.0	
06/96	\$614,000										100.0	
ANNUAL AVERAGE	\$591,750	0.0	0.0	0.0	0.0	0.0	0.0	0.0	0.0	0.0	100.0	0.0
09/96	\$606,000										100.0	
12/96	\$606,000										100.0	
03/97	\$614,000										100.0	
06/97	\$602,000										100.0	
ANNUAL AVERAGE	\$607,000	0.0	0.0	0.0	0.0	0.0	0.0	0.0	0.0	0.0	100.0	0.0
09/97	\$611,000										100.0	
12/97	\$605,000										100.0	
03/98	\$605,000										100.0	
06/98	\$606,000										100.0	
ANNUAL AVERAGE	\$606,750	0.0	0.0	0.0	0.0	0.0	0.0	0.0	0.0	0.0	100.0	0.0
09/98	\$606,000										100.0	
12/98	\$606,000										100.0	
03/99	\$606,000										100.0	
06/99	\$674,000										100.0	
ANNUAL AVERAGE	\$623,000	0.0	0.0	0.0	0.0	0.0	0.0	0.0	0.0	0.0	100.0	0.0
09/99	\$674,000										100.0	
12/99	\$674,000										100.0	
03/00	\$674,000										100.0	
06/00	\$1,036,000										100.0	
ANNUAL AVERAGE	\$764,500	0.0	0.0	0.0	0.0	0.0	0.0	0.0	0.0	0.0	100.0	0.0

VERMONT MUNICIPAL EMPLOYEES

ASSET ALLOCATION HISTORY

ALTERNATIVE INVESTMENTS

QUARTER ENDING	TOTAL VALUE	COMMON STOCK	INT'L C/S	BOND	INT'L BOND	CONV	CASH EQUIV	MORT	REAL ESTATE	SV ASSETS	PRVT INVEST	MISC
09/00	\$1,036,000										100.0	
12/00	\$1,037,000										100.0	
03/01	\$1,056,137						1.3				98.7	
06/01	\$1,116,579						6.6				93.4	
ANNUAL AVERAGE	\$1,061,429	0.0	0.0	0.0	0.0	0.0	2.0	0.0	0.0	0.0	98.0	0.0
09/01	\$1,117,282						6.7				93.3	
12/01	\$1,117,792						6.7				93.3	
03/02	\$1,118,176						6.8				93.3	
06/02	\$886,926						8.6				91.5	
ANNUAL AVERAGE	\$1,060,044	0.0	0.0	0.0	0.0	0.0	7.2	0.0	0.0	0.0	92.8	0.0
09/02	\$887,273						8.6				91.4	
12/02	\$887,581						8.6				91.4	
03/03	\$887,819						8.6				91.4	
06/03	\$829,498						9.3				90.7	
ANNUAL AVERAGE	\$873,043	0.0	0.0	0.0	0.0	0.0	8.8	0.0	0.0	0.0	91.2	0.0
09/03	\$829,689						9.3				90.7	
12/03	\$829,881						9.3				90.7	
03/04	\$830,073						9.3				90.7	
06/04	\$830,258						9.4				90.6	
ANNUAL AVERAGE	\$829,975	0.0	0.0	0.0	0.0	0.0	9.3	0.0	0.0	0.0	90.7	0.0
09/04	\$830,501						9.4				90.6	
12/04	\$739,976						21.4				78.6	
03/05	\$740,729						21.5				78.5	
06/05	\$632,414						25.3				74.7	
ANNUAL AVERAGE	\$735,905	0.0	0.0	0.0	0.0	0.0	19.4	0.0	0.0	0.0	80.6	0.0
OVERALL AVERAGE	\$775,340	0.0	0.0	0.0	0.0	0.0	4.7	0.0	0.0	0.0	95.3	0.0

VERMONT MUNICIPAL EMPLOYEES

ASSET ALLOCATION HISTORY

VERMONT INVESTMENTS

QUARTER ENDING	TOTAL VALUE	COMMON STOCK	INT'L C/S	BOND	INT'L BOND	CONV	CASH EQUIV	MORT	REAL ESTATE	SV ASSETS	PRVT INVEST	MISC
09/95	\$4,038,000						100.0					
12/95	\$4,592,000						100.0					
03/96	\$4,034,000						100.0					
06/96	\$3,359,000						100.0					
ANNUAL AVERAGE	\$3,505,750	0.0	0.0	0.0	0.0	0.0	100.0	0.0	0.0	0.0	0.0	0.0
09/96	\$5,435,000						100.0					
12/96	\$6,345,000						100.0					
03/97	\$7,030,000						100.0					
06/97	\$2,826,000						100.0					
ANNUAL AVERAGE	\$5,409,000	0.0	0.0	0.0	0.0	0.0	100.0	0.0	0.0	0.0	0.0	0.0
09/97	\$2,484,000						100.0					
12/97	\$1,899,000						100.0					
03/98	\$3,671,000						100.0					
06/98	\$3,311,000						100.0					
ANNUAL AVERAGE	\$3,091,250	0.0	0.0	0.0	0.0	0.0	100.0	0.0	0.0	0.0	0.0	0.0
09/98	\$2,566,000						100.0					
12/98	\$3,136,000						100.0					
03/99	\$4,155,000						100.0					
06/99	\$6,676,000						100.0					
ANNUAL AVERAGE	\$4,133,250	0.0	0.0	0.0	0.0	0.0	100.0	0.0	0.0	0.0	0.0	0.0
09/99	\$5,699,000						100.0					
12/99	\$3,978,000						100.0					
03/00	\$4,291,000						100.0					
06/00	\$6,551,000						100.0					
ANNUAL AVERAGE	\$6,629,750	0.0	0.0	0.0	0.0	0.0	100.0	0.0	0.0	0.0	0.0	0.0

VERMONT MUNICIPAL EMPLOYEES

ASSET ALLOCATION HISTORY

VERMONT INVESTMENTS

QUARTER ENDING	TOTAL VALUE	COMMON STOCK	INT'L C/S	BOND	INT'L BOND	CONV	CASH EQUIV	MORT	REAL ESTATE	SV ASSETS	PRVT INVEST	MISC
09/00	\$2,044,000						100.0					
12/00	\$2,473,000						100.0					
03/01	\$526,105			100.0								
06/01	\$3,782,280			17.6			82.4					
ANNUAL AVERAGE	\$2,206,346	0.0	0.0	29.4	0.0	0.0	70.6	0.0	0.0	0.0	0.0	0.0
09/01	\$4,335,254			15.2			84.8					
12/01	\$4,618,675			14.2			85.8					
03/02	\$854,034			11.0			89.0					
06/02	\$2,824,726			23.8			76.2					
ANNUAL AVERAGE	\$4,408,172	0.0	0.0	16.0	0.0	0.0	84.0	0.0	0.0	0.0	0.0	0.0
09/02	\$2,192,945			31.4			68.6					
12/02	\$4,050,358			17.0			83.0					
03/03	\$3,029,633			10.8			89.2					
06/03	\$350,546			95.0			5.0					
ANNUAL AVERAGE	\$2,405,871	0.0	0.0	38.6	0.0	0.0	61.4	0.0	0.0	0.0	0.0	0.0
09/03	\$1,107,804			30.7			69.3					
12/03	\$3,568,639			9.2			90.8					
03/04	\$3,581,281			5.1			94.9					
06/04	\$1,311,441			25.0			75.0					
ANNUAL AVERAGE	\$3,142,291	0.0	0.0	17.5	0.0	0.0	82.5	0.0	0.0	0.0	0.0	0.0
09/04	\$926,316			33.4			66.6					
12/04	\$644,685			48.6			51.4					
03/05	\$1,169,822			27.1			72.9					
06/05	\$438,447			71.1			28.9					
ANNUAL AVERAGE	\$794,818	0.0	0.0	45.0	0.0	0.0	55.0	0.0	0.0	0.0	0.0	0.0
OVERALL AVERAGE	\$3,572,650	0.0	0.0	14.7	0.0	0.0	85.3	0.0	0.0	0.0	0.0	0.0

VERMONT MUNICIPAL EMPLOYEES

POLICY INDEX DETAIL

POLICY ACCOUNT: R2W0200

MUNI POLICY INDEX

EFFECTIVE DATE: 03/ 92

40% S&P 500
5% 90 DAY T-BILLS
5% NCREIF CL PROP

35% LB AGGREGATE
5% PRIVATE EQ 12%

5% SSB WGBI EX US
5% MS EAFE NET

EFFECTIVE DATE: 03/ 96

48% S&P 500
7% CITI WGBI EX US

28% LB AGGREGATE
6% MS EAFE NET

7% NCREIF CL PROP
4% PRIVATE EQ 12%

EFFECTIVE DATE: 03/ 98

48% S&P 500
6% MS EAFE NET

30% LB AGGREGATE
5% CITI WGBI EX US

7% NCREIF CL PROP
4% PRIVATE EQ 12%

EFFECTIVE DATE: 09/ 98

43% S&P 500
7% NCREIF CL PROP

32% LB AGGREGATE
4% PRIVATE EQ 13%

14% MS EAFE NET

EFFECTIVE DATE: 03/ 01

30% LB AGGREGATE
15% R 1000(R) GR
2% PRIVATE EQ 13%

20% MS EAFE NET
10% R 2000(R)

16% R 1000(R) VALUE
7% NCREIF CL PROP

EFFECTIVE DATE: 10/ 02

32% LB AGGREGATE
14% MS EAFE NET
4% PRIVATE EQ 13%

17% R 1000(R) VALUE
10% R 2000(R)

16% R 1000(R) GR
7% NCREIF CL PROP

EFFECTIVE DATE: 05/ 03

27% LB AGGREGATE

17% R 1000(R) VALUE

16% R 1000(R) GR

VERMONT MUNICIPAL EMPLOYEES

POLICY INDEX DETAIL

16% MS EAFE NET
5% ML HIGH YIELD

10% R 2000(R)
2% PRIVATE EQ 13%

7% NCREIF PROPERTY

VERMONT MUNICIPAL EMPLOYEES

ALLOCATION INDEX DETAIL

ACCOUNT: R2W0201 DELAWARE

EFFECTIVE DATE: 06/ 00

COMMON STOCK:	S&P VALUE	CONVERTIBLES:	FB CONV BOND
CASH EQUIV.:	90 DAY T-BILLS	BONDS:	LB AGGREGATE
MORTGAGES:	CITI MORTGAGE	REAL ESTATE:	NCREIF CL PROP
INTL COMMON STK:	MS EAFE NET	INT'L BONDS:	ML WORLD BOND
STABLE VAL ASTS:	5YR GIC ROR	MISC:	DELAWARE
PRIVATE INVEST:	NASDAQ COMP	CASH:	DELAWARE

EFFECTIVE DATE: 10/ 02

COMMON STOCK:	R 1000(R) VALUE	CONVERTIBLES:	FB CONV BOND
CASH EQUIV.:	90 DAY T-BILLS	BONDS:	LB AGGREGATE
MORTGAGES:	CITI MORTGAGE	REAL ESTATE:	NCREIF CL PROP
INTL COMMON STK:	MS EAFE NET	INT'L BONDS:	ML WORLD BOND
STABLE VAL ASTS:	5YR GIC ROR	MISC:	DELAWARE
PRIVATE INVEST:	NASDAQ COMP	CASH:	DELAWARE

ACCOUNT: R2W0202 ALLIANCE LARGE CAP GROWTH FUND

EFFECTIVE DATE: 06/ 00

COMMON STOCK:	R 1000(R) GR	CONVERTIBLES:	FB CONV BOND
CASH EQUIV.:	90 DAY T-BILLS	BONDS:	LB AGGREGATE
MORTGAGES:	CITI MORTGAGE	REAL ESTATE:	NCREIF CL PROP
INTL COMMON STK:	MS EAFE NET	INT'L BONDS:	ML WORLD BOND
STABLE VAL ASTS:	5YR GIC ROR	MISC:	ALLIANCE
PRIVATE INVEST:	NASDAQ COMP	CASH:	ALLIANCE

VERMONT MUNICIPAL EMPLOYEES

ALLOCATION INDEX DETAIL

ACCOUNT: R2W0203

LAZARD SMALL CAP FUND

EFFECTIVE DATE: 06/00

COMMON STOCK:	R 2000(R)	CONVERTIBLES:	FB CONV BOND
CASH EQUIV.:	90 DAY T-BILLS	BONDS:	LB AGGREGATE
MORTGAGES:	CITI MORTGAGE	REAL ESTATE:	NCREIF CL PROP
INTL COMMON STK:	MS EAFE NET	INT'L BONDS:	ML WORLD BOND
STABLE VAL ASTS:	5YR GIC ROR	MISC:	LAZARD
PRIVATE INVEST:	NASDAQ COMP	CASH:	LAZARD

ACCOUNT: R2W0204

BRINSON - UBS

EFFECTIVE DATE: 06/00

COMMON STOCK:	S&P 500	CONVERTIBLES:	FB CONV BOND
CASH EQUIV.:	90 DAY T-BILLS	BONDS:	LB AGGREGATE
MORTGAGES:	CITI MORTGAGE	REAL ESTATE:	NCREIF CL PROP
INTL COMMON STK:	MS EAFE NET	INT'L BONDS:	ML WORLD BOND
STABLE VAL ASTS:	5YR GIC ROR	MISC:	UBS
PRIVATE INVEST:	NASDAQ COMP	CASH:	UBS

ACCOUNT: R2W0207

MET LIFE / SSR TOWER FUND

EFFECTIVE DATE: 06/00

COMMON STOCK:	S&P 500	CONVERTIBLES:	FB CONV BOND
CASH EQUIV.:	90 DAY T-BILLS	BONDS:	LB AGGREGATE
MORTGAGES:	CITI MORTGAGE	REAL ESTATE:	NCREIF PROPERTY
INTL COMMON STK:	MS EAFE NET	INT'L BONDS:	ML WORLD BOND
STABLE VAL ASTS:	5YR GIC ROR	MISC:	SSR TOWER FUND
PRIVATE INVEST:	NASDAQ COMP	CASH:	SSR TOWER FUND

VERMONT MUNICIPAL EMPLOYEES

ALLOCATION INDEX DETAIL

ACCOUNT: R2W0208 SEIX CORE

EFFECTIVE DATE: 06/ 00

COMMON STOCK:	S&P 500	CONVERTIBLES:	FB CONV BOND
CASH EQUIV.:	90 DAY T-BILLS	BONDS:	LB AGGREGATE
MORTGAGES:	CITI MORTGAGE	REAL ESTATE:	NCREIF CL PROP
INTL COMMON STK:	MS EAFE NET	INT'L BONDS:	ML WORLD BOND
STABLE VAL ASTS:	5YR GIC ROR	MISC:	SEIX CORE
PRIVATE INVEST:	NASDAQ COMP	CASH:	SEIX CORE

ACCOUNT: R2W0211 SEIX HIGH YIELD

EFFECTIVE DATE: 06/ 03

COMMON STOCK:	S&P 500	CONVERTIBLES:	FB CONV BOND
CASH EQUIV.:	90 DAY T-BILLS	BONDS:	CITI BB&B ALL
MORTGAGES:	CITI MORTGAGE	REAL ESTATE:	NCREIF CL PROP
INTL COMMON STK:	MS EAFE NET	INT'L BONDS:	ML WORLD BOND
STABLE VAL ASTS:	5YR GIC ROR	MISC:	SEIX HIGH YIELD
PRIVATE INVEST:	NASDAQ COMP	CASH:	SEIX HIGH YIELD

ACCOUNT: R2W0209 ALTERNATIVE INVESTMENTS

EFFECTIVE DATE: 06/ 00

COMMON STOCK:	S&P 500	CONVERTIBLES:	FB CONV BOND
CASH EQUIV.:	90 DAY T-BILLS	BONDS:	LB AGGREGATE
MORTGAGES:	CITI MORTGAGE	REAL ESTATE:	NCREIF CL PROP
INTL COMMON STK:	MS EAFE NET	INT'L BONDS:	ML WORLD BOND
STABLE VAL ASTS:	5YR GIC ROR	MISC:	ALT. ASSETS
PRIVATE INVEST:	NASDAQ COMP	CASH:	ALT. ASSETS

VERMONT MUNICIPAL EMPLOYEES

ALLOCATION INDEX DETAIL

ACCOUNT: R2W0210

VERMONT INVESTMENTS

EFFECTIVE DATE: 03/01

COMMON STOCK:	S&P 500	CONVERTIBLES:	FB CONV BOND
CASH EQUIV.:	90 DAY T-BILLS	BONDS:	LB AGGREGATE
MORTGAGES:	CITI MORTGAGE	REAL ESTATE:	NCREIF CL PROP
INTL COMMON STK:	MS EAFE NET	INT'L BONDS:	ML WORLD BOND
STABLE VAL ASTS:	5YR GIC ROR	MISC:	VERMONT INVEST
PRIVATE INVEST:	NASDAQ COMP	CASH:	VERMONT INVEST

VERMONT MUNICIPAL EMPLOYEES
COMMON STOCK HOLDINGS
AS OF 6/05

DELAWARE

<u>COMPANY NAME</u>	<u>SHARES</u>	<u>PRICE</u>	<u>PORT WT</u>	<u>MKT CAP</u>	<u>DIV YLD</u>	<u>P/E</u>	<u>P/B</u>	<u>QUARTER RETURN</u>
CONSUMER DISCRETIONARY STOCK								
KNIGHT RIDDER INC	11100	61.34	1.7	4.61	2.2	14.3	3.3	- 8.3
MCDONALD'S CORP	22100	27.75	1.5	35.17	2.0	14.1	2.4	- 10.9
NIKE INC	5800	86.60	1.2	22.73	1.2	18.8	4.0	4.3
VIACOM INC	25800	32.02	2.0	51.56	0.9	N/ A	1.3	- 7.9
WESTWOOD ONE INC	16700	20.43	0.8	1.89	2.0	20.8	2.5	0.9
			<u>7.3</u>	<u>26.79</u>	<u>1.6</u>	<u>16.3</u>	<u>2.6</u>	<u>- 5.5</u>
CONSUMER STAPLES STOCK								
ANHEUSER BUSCH COS INC COM	18000	45.75	2.0	35.52	2.1	16.5	13.7	- 3.0
CLOROX CO COM	5800	55.72	0.8	8.59	2.0	19.9	N/ A	- 11.2
GENERAL MILLS INC	12500	46.79	1.4	17.27	2.8	14.0	3.0	- 4.2
GILLETTE CO COM	4000	50.63	0.5	50.38	1.3	28.4	N/ M	0.6
PEPSICO INC COM	12800	53.93	1.7	90.44	1.9	21.4	6.5	2.2
PROCTER & GAMBLE CO	13900	52.75	1.8	131.58	2.1	19.1	7.1	0.1
WAL MART STORES INC	14900	48.20	1.8	201.57	1.2	19.4	4.3	- 3.5
			<u>10.0</u>	<u>87.35</u>	<u>2.0</u>	<u>18.8</u>	<u>7.3</u>	<u>- 2.3</u>
ENERGY RELATED STOCK								
BP AMOCO P L C	8600	62.38	1.3	223.80	3.0	13.0	2.9	0.8
CHEVRON CORP	13800	55.92	1.9	117.33	3.2	9.0	2.5	- 3.3
EXXON MOBIL CORP	16984	57.47	2.4	365.80	2.0	13.3	3.5	- 3.1
MARATHON OIL CORP	12800	53.37	1.7	18.56	2.1	13.9	2.2	14.5
MURPHY OIL CORP COM	8200	52.23	1.1	9.63	0.9	18.2	3.5	6.1
			<u>8.3</u>	<u>172.12</u>	<u>2.3</u>	<u>13.0</u>	<u>2.9</u>	<u>2.2</u>

VERMONT MUNICIPAL EMPLOYEES
COMMON STOCK HOLDINGS
AS OF 6/05

DELAWARE

<u>COMPANY NAME</u>	<u>SHARES</u>	<u>PRICE</u>	<u>PORT WT</u>	<u>MKT CAP</u>	<u>DIV YLD</u>	<u>P/E</u>	<u>P/B</u>	<u>QUARTER RETURN</u>
FINANCIAL STOCK								
AMERICAN EXPRESS CO	16100	53.23	2.1	66.27	0.9	18.5	4.1	3.9
BANK OF AMERICA CORP	37138	45.61	4.2	184.05	3.9	11.4	1.9	4.4
BANK OF NEW YORK	14200	28.78	1.0	22.35	2.8	15.3	2.4	-0.2
CITIGROUP INC	35600	46.23	4.0	240.50	3.8	14.1	2.2	3.9
J P MORGAN CHASE & CO	29996	35.32	2.6	124.51	3.9	28.5	1.2	3.1
MBNA CORP	29000	26.16	1.9	33.16	2.1	15.4	2.6	7.2
MELLON FINL CORP	14800	28.69	1.0	12.14	2.8	13.9	2.9	1.2
MERRILL LYNCH & CO INC	22700	55.01	3.1	52.00	1.5	11.4	1.7	-2.5
MORGAN STANLEY DEAN WITTER	28900	52.47	3.7	57.02	2.1	13.0	2.0	-7.9
PMI GROUP INC	19900	38.98	1.9	3.64	0.5	9.7	1.1	2.7
PRUDENTIAL FINL INC	14100	65.66	2.3	34.29	1.0	15.4	1.5	14.4
US BANCORP DEL	33895	29.20	2.5	53.80	4.1	12.9	2.8	2.4
			<u>30.3</u>	<u>95.41</u>	<u>2.6</u>	<u>14.7</u>	<u>2.1</u>	<u>2.4</u>
HEALTH CARE STOCK								
CIGNA CORP COM USD1	6400	107.03	1.7	14.01	0.1	7.9	2.6	19.9
GLAXO SMITHKLINE PLC	16900	48.51	2.0	138.09	3.2	16.5	12.2	6.4
PFIZER INC	55900	27.58	3.8	205.07	2.8	22.1	3.0	5.7
TENET HEALTHCARE CORP	34100	12.24	1.0	5.74	0.0	N/A	3.3	6.2
WYETH	24400	44.50	2.7	59.49	2.1	37.7	5.7	6.0
			<u>11.2</u>	<u>111.24</u>	<u>2.0</u>	<u>22.7</u>	<u>5.3</u>	<u>8.1</u>
INDUSTRIALS STOCK								
ARAMARK CORP	17300	26.40	1.1	4.85	0.8	18.1	3.9	0.7
AVERY DENNISON CORP	6900	52.96	0.9	5.31	2.9	18.5	3.5	-13.9

VERMONT MUNICIPAL EMPLOYEES
COMMON STOCK HOLDINGS
AS OF 6/05

DELAWARE

<u>COMPANY NAME</u>	<u>SHARES</u>	<u>PRICE</u>	<u>PORT WT</u>	<u>MKT CAP</u>	<u>DIV YLD</u>	<u>P/E</u>	<u>P/B</u>	<u>QUARTER RETURN</u>
CATERPILLAR INC	4900	95.31	1.1	32.57	1.7	14.8	4.2	4.7
GENERAL ELEC CO	39300	34.65	3.4	367.50	2.5	21.1	3.3	-3.3
GOODRICH CORP	9700	40.96	1.0	4.94	2.0	26.6	3.5	7.5
HONEYWELL INTL INC	10800	36.63	1.0	31.25	2.3	23.3	2.7	-1.0
PITNEY BOWES	9600	43.55	1.0	10.02	2.8	20.0	7.6	-2.8
			9.5	139.83	2.2	20.4	3.9	-1.5
INFORMATION TECHNOLOGY STOCK								
CISCO SYS INC	46700	19.11	2.2	122.30	0.0	22.7	5.1	6.7
INTEL CORP	33500	26.06	2.1	160.62	1.2	20.7	4.3	12.4
NATIONAL SEMICONDUCTOR COR	38100	22.03	2.1	7.69	0.4	18.7	3.7	7.0
ORACLE CORP	31300	13.20	1.0	67.91	0.0	23.6	6.3	5.8
			7.4	94.04	0.5	21.1	4.7	8.3
MATERIALS STOCK								
AIR PRODS & CHEMS INC COM	10400	60.30	1.5	13.82	2.1	20.2	2.8	-4.2
DOW CHEM CO	18700	44.53	2.1	42.80	3.0	11.5	3.2	-10.0
DU PONT E I DE NEMOURS & C	16200	43.01	1.7	42.83	3.4	20.7	3.7	-15.4
INTERNATIONAL PAPER COMPAN	12824	30.21	1.0	14.81	3.3	29.0	1.8	-17.3
			6.3	31.41	3.0	18.8	3.0	-11.2
TELECOMMUNICATIONS SERVICES STOCK								
ALLTEL CORP	15900	62.28	2.4	18.84	2.4	16.5	2.6	14.3
BCE INC	35900	23.68	2.1	21.94	4.4	17.9	2.1	-4.2
			4.5	20.28	3.4	17.2	2.4	5.7

VERMONT MUNICIPAL EMPLOYEES
COMMON STOCK HOLDINGS
AS OF 6/05

DELAWARE

<u>COMPANY NAME</u>	<u>SHARES</u>	<u>PRICE</u>	<u>PORT WT</u>	<u>MKT CAP</u>	<u>DIV YLD</u>	<u>P/E</u>	<u>P/B</u>	<u>QUARTER RETURN</u>
UTILITIES STOCK								
DOMINION RES INC VA NEW	6100	73.39	1.1	24.95	3.7	19.6	2.3	-0.5
EXELON CORP	6400	51.33	0.8	34.31	3.1	17.3	3.5	12.8
FPL GROUP INC	11400	42.06	1.2	16.49	3.4	17.1	2.0	5.7
			3.1	24.17	3.4	18.1	2.5	5.3

VERMONT MUNICIPAL EMPLOYEES
COMMON STOCK HOLDINGS
AS OF 6/05

ALLIANCE LARGE CAP GROWTH FUND

<u>COMPANY NAME</u>	<u>SHARES</u>	<u>PRICE</u>	<u>PORT WT</u>	<u>MKT CAP</u>	<u>DIV YLD</u>	<u>P/E</u>	<u>P/B</u>	<u>QUARTER RETURN</u>
CONSUMER DISCRETIONARY STOCK								
CARNIVAL CORP COM	7696	54.55	1.1	43.91	1.5	21.1	2.7	5.7
EBAY INC	36164	33.01	3.0	44.53	0.0	52.4	6.2	-11.4
LOWES COS INC	20500	58.22	3.0	45.00	0.3	19.5	3.7	2.1
PULTE HOMES INC	3950	84.25	0.8	10.87	0.2	9.9	2.3	14.5
SCRIPPS E W CO NEW	13825	48.80	1.7	7.97	0.9	26.2	3.7	0.3
STARBUCKS CORP	10080	51.66	1.3	20.56	0.0	46.5	7.9	0.0
TARGET CORP	11510	54.41	1.6	48.06	0.6	24.5	3.7	8.9
XM SATELLITE RADIO HLDGS I	13349	33.66	1.1	7.13	0.0	N/A	N/M	6.4
			<u>13.8</u>	<u>32.95</u>	<u>0.4</u>	<u>31.3</u>	<u>4.6</u>	<u>0.9</u>
CONSUMER STAPLES STOCK								
AVON PRODS INC	24075	37.85	2.3	17.87	1.5	20.7	N/M	-11.5
COLGATE PALMOLIVE CO	6061	49.91	0.8	26.11	2.3	20.9	N/M	-3.8
PROCTER & GAMBLE CO	16686	52.75	2.2	131.58	2.1	19.1	7.1	0.1
WHOLE FOODS MKT INC	1839	118.21	0.6	7.72	0.8	48.8	6.5	16.0
			<u>5.9</u>	<u>61.29</u>	<u>1.8</u>	<u>22.8</u>	<u>7.0</u>	<u>-3.5</u>
ENERGY RELATED STOCK								
BAKER HUGHES INC	11918	51.16	1.5	17.33	0.9	28.0	4.2	15.3
HALLIBURTON CO	15051	47.82	1.8	24.15	1.0	33.0	5.6	10.9
NABORS INDUSTRIES LTD	11510	60.62	1.8	9.56	0.0	25.4	3.0	2.5
			<u>5.2</u>	<u>17.07</u>	<u>0.6</u>	<u>28.8</u>	<u>4.3</u>	<u>9.3</u>
FINANCIAL STOCK								
ACE LTD	13621	44.85	1.6	12.89	1.9	11.7	1.3	9.2

VERMONT MUNICIPAL EMPLOYEES
COMMON STOCK HOLDINGS
AS OF 6/05

ALLIANCE LARGE CAP GROWTH FUND

<u>COMPANY NAME</u>	<u>SHARES</u>	<u>PRICE</u>	<u>PORT WT</u>	<u>MKT CAP</u>	<u>DIV YLD</u>	<u>P/E</u>	<u>P/B</u>	<u>QUARTER RETURN</u>
AFLAC INC	9739	43.28	1.1	21.73	1.0	16.7	2.8	16.5
AMERICAN INTL GROUP INC CO	16550	58.10	2.4	150.76	0.9	13.9	1.8	5.1
CITIGROUP INC	14098	46.23	1.7	240.50	3.8	14.1	2.2	3.9
FRANKLIN RES INC COM	8649	76.98	1.7	19.33	0.5	23.4	3.8	12.3
GOLDMAN SACHS GROUP INC	4086	102.02	1.1	47.66	1.0	11.2	1.9	-7.0
LEGG MASON INC	3473	104.11	0.9	11.38	0.6	26.4	5.0	33.5
PROGRESSIVE CORP OHIO COM	4563	98.81	1.1	19.72	0.1	12.9	3.7	7.7
			<u>11.5</u>	<u>80.27</u>	<u>1.3</u>	<u>15.9</u>	<u>2.6</u>	<u>9.0</u>
HEALTH CARE STOCK								
ALCON INC	10556	109.35	2.9	33.42	0.9	35.9	14.1	23.7
AMGEN INC	13825	60.46	2.1	74.79	0.0	30.1	3.9	3.9
CAREMARK RX INC	15869	44.52	1.8	20.02	0.0	28.2	2.6	11.9
GENENTECH INC	13349	80.28	2.7	84.81	0.0	94.4	12.1	41.8
GILEAD SCIENCES INC	17231	43.99	1.9	19.82	0.0	39.3	9.6	22.9
LILLY ELI & CO	7764	55.71	1.1	63.12	2.7	28.0	5.4	7.6
ST JUDE MED INC COM	25880	43.61	2.9	15.76	0.0	35.9	6.3	21.1
TEVA PHARMACEUTICAL INDS L	24484	31.14	1.9	19.04	0.8	21.2	3.6	0.7
UNITEDHEALTH GROUP INC	25676	52.14	3.4	66.11	0.0	23.5	6.3	9.3
WELLPOINT INC	2316	69.64	0.4	42.65	0.0	21.7	2.1	11.1
ZIMMER HLDGS INC	9126	76.17	1.8	18.81	0.0	30.1	4.5	-2.1
			<u>23.0</u>	<u>43.03</u>	<u>0.3</u>	<u>37.8</u>	<u>7.3</u>	<u>15.7</u>
INDUSTRIALS STOCK								
AMERICAN STD COS INC DEL	9739	41.92	1.0	8.92	1.4	25.4	10.3	-9.5
APOLLO GROUP INC	6538	78.22	1.3	14.12	0.0	64.1	N/ M	5.6
BOEING COM \$US5	3201	66.00	0.5	51.94	1.5	30.7	4.5	13.4

VERMONT MUNICIPAL EMPLOYEES
COMMON STOCK HOLDINGS
AS OF 6/05

ALLIANCE LARGE CAP GROWTH FUND

<u>COMPANY NAME</u>	<u>SHARES</u>	<u>PRICE</u>	<u>PORT WT</u>	<u>MKT CAP</u>	<u>DIV YLD</u>	<u>P/E</u>	<u>P/B</u>	<u>QUARTER RETURN</u>
GENERAL ELEC CO	39093	34.65	3.4	367.50	2.5	21.1	3.3	- 3.3
UNITED PARCEL SVC INC	6334	69.16	1.1	77.18	1.9	22.5	4.7	- 4.5
			<u>7.4</u>	<u>189.30</u>	<u>1.8</u>	<u>30.1</u>	<u>4.8</u>	<u>- 1.6</u>

INFORMATION TECHNOLOGY STOCK

APPLE COMPUTER INC	29898	36.81	2.8	30.30	0.0	38.7	4.7	- 11.7
BROADCOM CORP	16543	35.53	1.5	11.82	0.0	46.1	4.8	18.7
CORNING INC	49445	16.62	2.1	23.63	0.0	N/ A	5.7	49.3
DELL INC	39365	39.46	3.9	96.36	0.0	30.1	N/ M	2.7
E M C CORP MASS	30988	13.71	1.1	32.94	0.0	33.4	2.8	11.3
ELECTRONIC ARTS INC	21385	56.61	3.1	17.57	0.0	34.3	5.0	9.3
GOOGLE INC	6279	294.15	4.7	79.59	0.0	100.4	N/ M	63.0
JUNIPER NETWORKS INC	43247	25.18	2.8	13.72	0.0	76.3	2.2	14.1
MARVELL TECHNOLOGY GROUP L	19070	37.97	1.8	10.61	0.0	54.2	4.1	- 1.0
MICROSOFT CORP	26766	24.84	1.7	268.37	1.3	23.9	5.7	3.1
NETWORK APPLIANCE INC	10148	28.27	0.7	10.35	0.0	44.9	6.2	2.2
QUALCOMM INC	33031	33.01	2.8	54.17	1.1	28.0	5.1	- 9.7
YAHOO INC	48696	34.65	4.3	48.10	0.0	50.2	6.7	2.2
			<u>33.3</u>	<u>56.23</u>	<u>0.2</u>	<u>50.9</u>	<u>4.9</u>	<u>14.2</u>

VERMONT MUNICIPAL EMPLOYEES
COMMON STOCK HOLDINGS
AS OF 6/05

LAZARD SMALL CAP FUND

<u>COMPANY NAME</u>	<u>SHARES</u>	<u>PRICE</u>	<u>PORT WT</u>	<u>MKT CAP</u>	<u>DIV YLD</u>	<u>P/E</u>	<u>P/B</u>	<u>QUARTER RETURN</u>
CONSUMER DISCRETIONARY STOCK								
99 CENTS ONLY STORES	7357	12.71	0.4	0.88	0.0	32.6	1.8	-3.5
ADVO INC	9775	31.85	1.2	1.00	1.4	21.8	6.0	-14.7
ALLIANCE GAMING CORP	19871	14.02	1.1	0.72	0.0	N/A	4.0	46.2
ANNTAYLOR STORES CORP	8377	24.28	0.8	1.77	0.0	35.7	1.8	-5.1
ARBITRON INC	6255	42.90	1.1	1.35	0.9	21.3	N/M	0.2
CARMIKE CINEMAS INC	3381	30.68	0.4	0.38	2.3	12.8	1.5	-16.8
CBRL GROUP INC	4948	38.86	0.8	1.83	1.2	15.9	2.2	-5.6
CSK AUTO INC	12128	16.68	0.8	0.75	0.0	23.5	3.4	-5.5
DICKS SPORTING GOODS INC	4651	38.59	0.7	1.90	0.0	36.4	6.0	5.1
FINISH LINE INC	522	18.92	0.0	0.93	0.5	14.4	2.3	-18.2
FOSSIL INC	6016	22.70	0.5	1.62	0.0	16.4	3.0	-12.4
GYMBOREE CORP	13936	13.66	0.8	0.43	0.0	28.5	1.9	8.9
HELEN OF TROY LTD-NEW	4137	25.46	0.4	0.76	0.0	9.9	1.8	-7.0
HOT TOPIC INC	6522	19.13	0.5	0.86	0.0	22.0	4.4	-12.4
JOURNAL REGISTER CO	15253	17.51	1.1	0.74	0.0	6.4	3.5	4.9
LIBERTY CORP COM	6064	36.81	0.9	0.68	2.7	18.0	2.2	-8.6
R H DONNELLEY CORP	4281	61.98	1.0	1.96	0.0	N/A	N/A	6.7
TBC CORP NEW	7663	27.13	0.8	0.61	0.0	15.7	1.9	-2.6
TIMBERLAND CO	6080	38.72	0.9	2.62	0.0	16.3	5.0	9.2
TRACTOR SUPPLY CO	3871	49.10	0.8	1.91	0.0	30.7	5.0	12.5
WINNEBAGO INDS INC	3847	32.75	0.5	1.09	0.9	16.1	4.9	3.9
			15.5	1.23	0.5	21.0	3.5	1.8
CONSUMER STAPLES STOCK								
DELTA & PINE LD CO	5863	25.06	0.6	0.91	1.9	44.0	5.0	-6.8
PERFORMANCE FOOD GROUP CO	8193	30.21	1.0	1.42	0.0	28.2	1.6	9.1

VERMONT MUNICIPAL EMPLOYEES
COMMON STOCK HOLDINGS
AS OF 6/05

LAZARD SMALL CAP FUND

<u>COMPANY NAME</u>	<u>SHARES</u>	<u>PRICE</u>	<u>PORT WT</u>	<u>MKT CAP</u>	<u>DIV YLD</u>	<u>P/E</u>	<u>P/B</u>	<u>QUARTER RETURN</u>
RALCORP HLDGS INC NEW	1888	41.15	0.3	1.22	0.0	16.9	2.5	-13.1
			1.9	1.23	0.6	31.3	2.8	0.5
ENERGY RELATED STOCK								
BRIGHAM EXPL CO	10080	9.13	0.4	0.38	0.0	21.2	2.1	-1.1
DENBURY RES INC DEL	3149	39.77	0.5	2.26	0.0	24.4	3.9	12.9
ENERGY PARTNERS LTD	5430	26.21	0.6	0.98	0.0	15.7	2.9	0.9
FOREST OIL CORP	4249	42.00	0.7	2.55	0.0	17.3	1.7	3.7
GREY WOLF INC	25839	7.41	0.8	1.41	0.0	37.0	5.4	12.6
KEY ENERGY GROUP INC	37068	12.10	1.8	1.57	0.0	N/A	N/A	5.5
KINDER MORGAN MGMT LLC	6411	46.00	1.2	2.54	0.0	31.1	1.7	15.3
MAVERICK TUBE CORP	7984	29.80	0.9	1.28	0.0	6.5	2.0	-8.3
OIL STS INTL INC	3992	25.17	0.4	1.26	0.0	18.2	2.2	22.5
OMI CORP NEW	10193	19.01	0.8	1.62	1.5	6.3	1.9	-0.3
RANGE RES CORP	7140	26.90	0.8	2.15	0.3	35.4	4.0	15.2
TODCO	7687	25.67	0.8	1.56	0.0	N/M	3.2	-0.7
VERITAS DOC INC	11205	27.74	1.2	0.93	0.0	20.5	1.7	-7.4
			10.7	1.62	0.1	21.5	2.6	4.6
FINANCIAL STOCK								
ALEXANDRIA REAL ESTATE EQU	2313	73.45	0.7	1.55	3.7	32.8	2.9	15.1
ARCH CAPITAL GROUP LTD	6932	45.05	1.2	1.58	0.0	4.4	0.7	12.5
ASSURED GUARANTY LTD COM	13063	23.36	1.2	1.75	0.5	9.7	1.1	30.3
BANK OF THE OZARKS INC	7157	32.84	0.9	0.55	1.1	19.8	4.3	3.7
BANKUNITED FINL CORP CLASS	5100	27.04	0.5	0.82	0.1	14.8	1.6	0.7
BIOMED RLTY TR INC	5759	23.85	0.5	0.75	4.5	53.0	1.8	17.2
BOSTON PRIVATE FINL HLDGS	5703	25.20	0.6	0.71	1.1	19.2	2.1	6.4

VERMONT MUNICIPAL EMPLOYEES
COMMON STOCK HOLDINGS
AS OF 6/05

LAZARD SMALL CAP FUND

<u>COMPANY NAME</u>	<u>SHARES</u>	<u>PRICE</u>	<u>PORT WT</u>	<u>MKT CAP</u>	<u>DIV YLD</u>	<u>P/E</u>	<u>P/B</u>	<u>QUARTER RETURN</u>
BRANDYWINE RLTY TR	4924	30.65	0.6	1.70	5.7	33.3	1.5	9.6
BRISTOL WEST HLDGS INC	9454	18.30	0.7	0.58	1.5	9.1	1.8	18.6
CALAMOS ASSET MGMT INC CL	3181	27.24	0.3	0.63	1.0	16.3	3.8	1.5
CAPITAL AUTOMOTIVE REIT	4843	38.16	0.7	1.67	4.6	27.5	1.8	16.7
CARRAMERICA REALTY CORP	4103	36.18	0.6	2.00	5.5	14.6	2.5	16.4
FINANCIAL FEDERAL CORP	4265	38.64	0.7	0.67	1.0	18.6	2.0	9.2
FIRST CMNTY BANCORP CALIF	4112	47.50	0.8	0.78	2.1	18.9	2.0	7.8
FIRST MIDWEST BANCORP INC	5116	35.08	0.7	1.60	2.9	16.2	3.1	8.8
LEXINGTON CORPORATE PPTYS	5992	24.31	0.6	1.19	5.9	35.8	1.9	12.5
MAF BANCORP INC	5783	42.63	1.0	1.39	2.2	13.9	1.5	3.2
MB FINANCIAL INC	6048	39.83	1.0	1.13	1.3	16.9	2.4	4.3
MILLS CORP	3622	60.79	0.9	3.39	4.1	30.7	6.7	16.2
PRENTISS PPTYS TR	3920	36.44	0.6	1.64	6.1	39.6	2.0	8.3
PROVIDENT BANKSHARES CORP	4377	31.91	0.6	1.06	3.4	15.8	1.7	-2.3
REINSURANCE GROUP AMER INC	2241	46.51	0.4	2.91	0.8	11.6	1.3	9.4
SCOTTISH ANNUITY REGROUP L	4602	24.24	0.4	0.97	0.8	9.5	1.1	7.9
SOUTH FINL GROUP INC	4329	28.42	0.5	2.04	2.3	15.7	1.5	-6.4
STERLING BANCSHARES INC	13478	15.56	0.8	0.70	1.5	25.5	2.2	10.1
TEXAS REGL BANCSHARES INC	6458	30.48	0.8	1.51	1.6	18.0	2.5	1.6
UMPQUA HLDGS CORP	7912	23.54	0.7	1.05	1.0	18.8	1.5	1.1
UNITED BANKSHARES INC	3807	35.61	0.5	1.52	2.9	18.0	2.4	8.3
WESTAMERICA BANCORPORATION	3124	52.81	0.7	1.74	2.3	17.9	4.0	2.6
			<u>20.1</u>	<u>1.38</u>	<u>2.3</u>	<u>19.8</u>	<u>2.3</u>	<u>9.5</u>

HEALTH CARE STOCK

ADVANCED MED OPTICS INC	5181	39.75	0.8	1.48	0.0	N/A	5.7	9.8
ALDERWOODS GROUP INC	5558	14.35	0.3	0.57	0.0	N/A	1.0	15.4
BIOSCRIP INC COM	28939	6.00	0.7	0.22	0.0	20.7	1.0	-0.5

VERMONT MUNICIPAL EMPLOYEES
COMMON STOCK HOLDINGS
AS OF 6/05

LAZARD SMALL CAP FUND

<u>COMPANY NAME</u>	<u>SHARES</u>	<u>PRICE</u>	<u>PORT WT</u>	<u>MKT CAP</u>	<u>DIV YLD</u>	<u>P/E</u>	<u>P/B</u>	<u>QUARTER RETURN</u>
CANDELA CORP	7132	10.45	0.3	0.24	0.0	30.7	3.3	17.2
CONNETICS CORP	10747	17.64	0.7	0.61	0.0	34.6	6.4	-30.2
FIRST HORIZON PHARMACEUTIC	1124	19.04	0.1	0.67	0.0	23.2	2.1	12.8
HANGER ORTHOPEDIC CORP	22666	5.04	0.5	0.11	0.0	N/A	0.7	-15.3
KINDRED HEALTHCARE INC	3494	39.61	0.5	1.52	0.0	14.1	2.0	12.8
LIFEPOINT HOSPS INC	3317	50.55	0.7	1.97	0.0	21.2	3.5	15.3
MATTHEWS INTL CORP CLASS A	2345	38.96	0.4	1.24	0.5	21.3	3.9	19.1
MOLINA HEALTHCARE INC	1896	44.26	0.3	1.17	0.0	20.4	3.4	-4.0
PSS WORLD MED INC	23558	12.45	1.2	0.81	0.0	20.4	2.9	9.5
TARO PHARMACEUTICAL INDS L	8233	29.07	0.9	0.84	0.0	N/M	2.4	-7.9
			7.4	0.93	0.0	22.8	3.2	2.1

INDUSTRIALS STOCK

AIRTRAN HLDGS INC	23526	9.23	0.9	0.80	0.0	N/M	2.4	2.0
APPLIED SIGNAL TECHNOLOGY	2490	19.04	0.2	0.22	2.6	20.9	2.3	-16.3
CHICAGO BRDG & IRON CO N V	7253	22.86	0.7	2.23	0.5	33.1	4.6	3.9
DEVRY INC DEL	6602	19.90	0.5	1.40	0.0	39.0	2.8	5.2
DRS TECHNOLOGIES INC	3775	51.28	0.8	1.41	0.2	23.9	2.1	20.7
ELKCORP	4490	28.55	0.5	0.57	0.7	12.4	2.2	-25.6
ENGINEERED SUPPORT SYS INC	5285	35.83	0.7	1.49	0.1	17.4	3.5	0.5
ESTERLINE CORP	6096	40.08	1.0	1.01	0.0	19.7	1.7	16.0
FEDERAL SIGNAL CORP	7373	15.60	0.5	0.75	1.5	N/A	1.9	3.2
FORWARD AIR CORP	6265	28.27	0.7	0.91	0.6	24.9	4.9	-0.2
KENNAMETAL INC COM	1590	45.85	0.3	1.73	1.5	15.0	1.7	-3.1
KNOLL INC	6128	17.11	0.4	0.86	1.2	28.0	N/A	2.9
LEARNING TREE INTERNATIONA	16642	11.90	0.8	0.20	0.0	N/M	3.0	-17.4
MILLER HERMAN INC COM	4361	30.84	0.5	2.16	0.9	31.8	12.7	2.6
PACER INTL INC TENN	9952	21.79	0.9	0.81	0.0	16.4	2.9	-8.8

VERMONT MUNICIPAL EMPLOYEES
COMMON STOCK HOLDINGS
AS OF 6/05

LAZARD SMALL CAP FUND

<u>COMPANY NAME</u>	<u>SHARES</u>	<u>PRICE</u>	<u>PORT WT</u>	<u>MKT CAP</u>	<u>DIV YLD</u>	<u>P/E</u>	<u>P/B</u>	<u>QUARTER RETURN</u>
ROPER INDS INC	3406	71.37	1.0	3.04	0.6	26.5	2.7	9.1
SHAW GROUP INC	12201	21.51	1.0	1.39	0.0	33.1	1.5	-1.3
SWIFT TRANSN INC	6112	23.29	0.6	1.68	0.0	15.3	2.2	5.2
TETRA TECH INC NEW	16891	13.53	0.9	0.77	0.0	N/A	2.7	7.2
UNITED RENTALS INC	8964	20.21	0.7	1.57	0.0	N/A	1.5	0.0
WABASH NATL CORP	3430	24.23	0.3	0.75	0.7	9.9	4.1	-0.5
WASTE CONNECTIONS INC	4104	37.29	0.6	1.75	0.0	23.5	2.5	7.3
WATSON WYATT & CO HLDGS	10136	25.63	1.0	0.84	1.2	16.1	2.9	-5.5
			15.3	1.27	0.4	23.1	3.0	1.3

INFORMATION TECHNOLOGY STOCK

AMIS HLDGS INC	11574	13.34	0.6	1.07	0.0	38.1	3.9	18.2
AVOCENT CORP	5004	26.14	0.5	1.31	0.0	113.7	1.9	1.9
BEARINGPOINT INC	29172	7.33	0.8	1.46	0.0	N/A	1.2	-16.4
BENCHMARK ELECTRS INC	6671	30.42	0.8	1.27	0.0	17.2	1.6	-4.4
BISYS GROUP INC	13887	14.94	0.8	1.79	0.0	22.3	2.2	-4.7
BROOKS AUTOMATION INC NEW	8226	14.85	0.5	0.67	0.0	39.1	2.1	-2.2
C COR ELECTRONICS INC COM	27059	6.85	0.7	0.33	0.0	N/A	1.5	12.7
COHERENT INC COM	5912	36.01	0.8	1.11	0.0	27.5	1.8	6.7
COMMSCOPE INC	15960	17.41	1.1	0.95	0.0	10.6	2.1	16.4
DOT HILL SYS CORP	27213	5.24	0.6	0.23	0.0	14.2	1.2	-11.9
EXAR CORP	18562	14.89	1.1	0.63	0.0	114.5	1.3	11.1
FOUNDRY NETWORKS INC	18233	8.62	0.6	1.19	0.0	31.9	1.6	-12.9
INTEGRATED DEVICE TECHNOLO	22209	10.75	0.9	1.14	0.0	82.7	1.4	-10.6
METROLOGIC INSTRS INC	9373	12.54	0.5	0.28	0.0	12.7	1.9	-44.2
MPS GROUP INC	22490	9.42	0.8	0.98	0.0	24.8	1.2	-10.4
OPLINK COMMUNICATIONS INC	26209	1.65	0.2	0.25	0.0	N/A	1.1	5.1
PHOTON DYNAMICS INC	8675	20.61	0.7	0.35	0.0	29.0	2.2	8.1

VERMONT MUNICIPAL EMPLOYEES
COMMON STOCK HOLDINGS
AS OF 6/05

LAZARD SMALL CAP FUND

<u>COMPANY NAME</u>	<u>SHARES</u>	<u>PRICE</u>	<u>PORT WT</u>	<u>MKT CAP</u>	<u>DIV YLD</u>	<u>P/E</u>	<u>P/B</u>	<u>QUARTER RETURN</u>
PLEXUS CORP	10675	14.23	0.6	0.62	0.0	N/A	1.7	23.6
POLYCOM INC	14161	14.91	0.8	1.46	0.0	30.4	1.5	-12.0
RADISYS CORP	7108	16.15	0.5	0.32	0.0	24.1	1.6	14.1
ROGERS CORP COM	5582	40.55	0.9	0.66	0.0	20.3	2.4	1.4
SAFENET INC	6000	34.06	0.8	0.84	0.0	N/M	1.4	16.2
SECURE COMPUTING CORP	18048	10.88	0.8	0.39	0.0	26.5	4.1	27.0
SERENA SOFTWARE INC	11590	19.30	0.9	0.79	0.0	36.4	2.9	-18.8
TITAN CORP COM	8032	22.74	0.7	1.93	0.0	68.9	5.2	25.2
TTM TECHNOLOGIES INC	25518	7.61	0.8	0.31	0.0	11.7	1.4	-27.2
WRIGHT EXPRESS CORP	12490	18.47	0.9	0.74	0.0	N/A	N/M	8.0
			<u>19.8</u>	<u>0.90</u>		<u>38.9</u>	<u>2.0</u>	<u>1.1</u>

MATERIALS STOCK

CLEVELAND CLIFFS INC COM	1815	57.76	0.4	1.26	0.7	3.7	2.8	-20.6
FOUNDATION COAL HLDGS INC	5165	25.94	0.5	1.16	0.6	N/A	4.2	10.5
OLIN CORP COM	10586	18.24	0.8	1.30	4.4	15.1	3.3	-17.3
PACKAGING CORP AMER	5687	21.05	0.5	2.26	4.8	25.4	2.8	-12.3
POLYONE CORPORATION-W/I	18032	6.62	0.5	0.61	0.0	15.4	1.6	-25.5
RTI INTL METALS INC	8594	31.41	1.1	0.70	0.0	N/M	2.0	34.2
SCOTTS MIRACLE GRO CO	3984	71.21	1.1	2.37	0.0	19.5	2.6	1.4
SPARTECH CORP	12667	17.80	0.9	0.57	2.7	24.4	1.4	-9.7
			<u>5.7</u>	<u>1.29</u>	<u>1.5</u>	<u>18.4</u>	<u>2.5</u>	<u>-0.8</u>

TELECOMMUNICATIONS SERVICES STOCK

WIRELESS FACS INC	22948	6.33	0.6	0.45	0.0	90.4	2.0	1.3
			<u>0.6</u>	<u>0.45</u>		<u>90.4</u>	<u>2.0</u>	<u>1.3</u>

VERMONT MUNICIPAL EMPLOYEES
COMMON STOCK HOLDINGS
AS OF 6/05

LAZARD SMALL CAP FUND

<u>COMPANY NAME</u>	<u>SHARES</u>	<u>PRICE</u>	<u>PORT WT</u>	<u>MKT CAP</u>	<u>DIV YLD</u>	<u>P/E</u>	<u>P/B</u>	<u>QUARTER RETURN</u>
UTILITIES STOCK								
AGL RES INC	7325	38.65	1.1	2.98	3.2	15.8	2.1	11.6
CLECO CORP NEW	10675	21.57	0.9	1.07	4.2	17.5	2.0	2.4
NEW JERSEY RES CORP COM	3141	48.25	0.6	1.32	2.8	17.0	2.6	11.7
			2.6	1.94	3.5	16.7	2.1	8.4

VERMONT MUNICIPAL EMPLOYEES

BOND HOLDINGS

AS OF 6/05

SEIX CORE

	<u>BOND NAME</u>	<u>MARKET VALUE</u>	<u>COUPON</u>	<u>STATED MATURITY</u>	<u>MOODY RATE</u>	<u>DUR-ATION</u>	<u>YIELD TO MATURITY</u>
0-5 YEARS	AMERICAN STANDARD INC	155,777	7.63	2/15/10	BAA3	3.84	4.77%
	AM_EX_CAMT_2001-001- A	483,154	3.36	9/15/08	AAA	0.04	3.35%
	BANK_ONE_2003-002A- A	398,698	3.27	10/15/08	AAA	0.04	3.40%
	BA_MTG_CC_2001-A- A	466,155	3.34	6/15/08	AAA	0.04	3.37%
	BNP US FDG 144A	130,691	7.74	12/05/07	A1	2.21	4.37%
	CITIBANK_CC_2002-A5- A5	279,363	3.45	9/15/07	AAA	-0.04	4.12%
	DEERE JOHN CAP CORP	65,857	3.90	1/15/08	A3	2.35	4.16%
	GOLDEN WEST FINL	96,756	4.13	8/15/07	A1	1.99	4.01%
	HARLEY DAVIDSON FDG MTN 14	63,337	3.63	12/15/08	A1	3.21	4.19%
	MERRILL LYNCH & CO MTN	39,772	3.70	4/21/08	AA3	2.62	4.14%
	MONUMENTAL GBL FDG 144A	114,423	5.20	1/30/07	AA3	1.48	3.98%
	NCR CORP NEW	37,848	7.13	6/15/09	BAA3	3.45	4.83%
	NORTHERN STATES PWR MN	45,013	2.88	8/01/06	A2	1.04	4.00%
	PANHANDLE EASTERN PL	66,686	4.80	8/15/08	BAA3	2.83	4.37%
	PANHANDLE EASTERN PL	39,252	2.75	3/15/07	BAA3	1.63	4.35%
	PENNZENERGY CO	25,945	10.25	11/01/05	BAA2	0.33	4.44%
	PRUDENTIAL FINL INC MTN	44,629	3.75	5/01/08	A3	2.65	4.08%
	PUB SVC COLO	116,384	4.38	10/01/08	A3	2.98	4.27%
	PULTE HOMES INC	92,383	4.88	7/15/09	BAA3	3.55	4.83%
	SIMON PPTY GROUP	47,500	6.38	11/15/07	BAA2	2.18	4.40%
	UNITED STATES TREAS BILL	1,098,790	0.00	7/14/05	AAA	0.04	2.69%
	UNITED STATES TREAS BONDS	2,399,355	10.75	8/15/05	GOVT	0.12	3.36%
	UNITED STATES TREAS NTS	477,233	6.50	8/15/05	GOVT	0.12	3.21%
	UNITED STATES TREAS NTS	226,550	3.75	5/15/08	AAA	2.69	3.67%
	UNITED STATES TREAS NTS	992,298	3.63	6/15/10	AAA	4.49	3.72%
	UNITED STATES TREAS NTS	7,208,769	6.00	8/15/09	GOVT	3.60	3.72%
	UNITED STATES TREAS NTS	8,607,321	3.13	5/15/07	GOVT	1.79	3.65%
	UNITED STATES TREAS NTS	2,794,386	3.50	11/15/06	GOVT	1.33	3.58%

VERMONT MUNICIPAL EMPLOYEES

BOND HOLDINGS

AS OF 6/05

SEIX CORE

	<u>BOND NAME</u>	<u>MARKET VALUE</u>	<u>COUPON</u>	<u>STATED MATURITY</u>	<u>MOODY RATE</u>	<u>DUR-ATION</u>	<u>YIELD TO MATURITY</u>
	UNITED STATES TREAS NTS	2,404,674	3.50	5/31/07	AAA	1.83	3.67%
	UNITED STATES TREAS NTS	1,512,180	1.50	7/31/05	GOVT	0.08	3.08%
		<u>30,531,177</u>	<u>4.45</u>			<u>1.90</u>	<u>3.59%</u>
5-10 YEARS	BANK OF AMERICA	248,918	7.40	1/15/11	AA3	4.48	4.43%
	CAPITAL ONE FINL CORP	100,373	4.80	2/21/12	BAA3	5.53	4.89%
	CENTERPOINT ENERGY RES	144,899	7.88	4/01/13	BA1	5.88	4.93%
	CIT GROUP INC	174,038	5.13	9/30/14	A2	7.23	4.90%
	CITIGROUP INC	93,994	5.13	5/05/14	AA1	7.04	4.52%
	COMCAST CABLE	230,693	7.13	6/15/13	BAA2	6.17	4.89%
	CORPORACION NACIONAL DEL C	116,381	5.50	10/15/13	A2	N/A	N/A
	COX COMMUNICATIONS INC	97,185	4.63	6/01/13	BAA3	6.52	5.08%
	CREDIT SUISSE FIRST BOSTON	108,231	6.50	1/15/12	AA3	N/A	N/A
	DONNELLEY RR & SONS	158,044	4.95	4/01/14	BAA2	6.94	5.27%
	ENTERGY GULF STATES	124,416	4.88	11/01/11	BAA3	2.90	4.97%
	ERAC USA FIN CO 144A	82,932	5.60	5/01/15	BAA1	7.47	5.16%
	FNMA(15Y)5 03-1.7.18 P390	901,901	5.00	6/30/15	GOVT	N/A	N/A
	FORD MOTOR CRED	205,779	7.00	10/01/13	BAA2	6.21	7.67%
	FUND AMERN COS	236,027	5.88	5/15/13	BAA2	6.26	5.22%
	GENL ELEC CO	410,332	5.00	2/01/13	AAA	6.19	4.49%
	GOLDMAN SACHS GROUP	255,476	4.75	7/15/13	AA3	6.49	4.76%
	GTECH HLDGS CORP	60,200	4.75	10/15/10	BAA1	4.59	4.85%
	HARRAHS OPER INC	65,441	5.38	12/15/13	BAA3	6.74	5.16%
	JP MORGAN CHASE	311,907	6.63	3/15/12	A1	5.38	4.64%
	LENNAR CORP	69,754	5.95	3/01/13	BAA3	6.06	4.96%
	MARRIOTT INTL INC NEW	124,361	4.63	6/15/12	BAA2	5.87	4.79%
	MBNA CORP MTN	235,278	6.13	3/01/13	BAA2	6.03	4.72%
	MERRILL LYNCH & CO MTN	120,285	5.00	1/15/15	AA3	7.38	4.69%

VERMONT MUNICIPAL EMPLOYEES

BOND HOLDINGS

AS OF 6/05

SEIX CORE

	<u>BOND NAME</u>	<u>MARKET VALUE</u>	<u>COUPON</u>	<u>STATED MATURITY</u>	<u>MOODY RATE</u>	<u>DUR-ATION</u>	<u>YIELD TO MATURITY</u>
	METLIFE INC	86,403	5.00	6/15/15	A2	7.77	4.81%
	MORGAN STANLEY GROUP	326,201	5.30	3/01/13	AA3	6.19	4.68%
	MOTIVA ENTERPRISES LLC 144	78,563	5.20	9/15/12	A2	5.91	4.69%
	NEWS AMERICA HLDGS INC	125,053	9.25	2/01/13	BAA3	5.56	5.02%
	PRUDENTIAL FINL INC MTN	83,009	5.10	9/20/14	A3	7.21	4.70%
	PULTE HOMES INC	61,435	5.25	1/15/14	BAA3	6.67	5.25%
	SLM_STUDENT_2005-003- A2	484,441	3.48	10/25/13	AAA	-0.18	3.64%
	UNITED STATES TREAS NTS	1,411,964	4.25	11/15/14	GOVT	7.66	3.95%
	UNITED STATES TREAS NTS	5,581,190	4.25	8/15/13	GOVT	6.74	3.89%
	UNITED TECHNOLOGIES	170,477	4.88	5/01/15	A2	7.70	4.58%
		<u>13,085,579</u>	<u>4.83</u>			<u>6.35</u>	<u>4.27%</u>
10-20 YEARS	FHLMC GOLD POOL - B10460	217,961	4.50	10/01/18	GOVT	3.17	4.59%
	FNMA TBA JUL 15 SINGLE	883,915	4.50	5/30/18	GOVT	N/A	N/A
	FNMA POOL - 713567	105,601	5.50	4/01/18	GOVT	1.50	4.42%
	FNMA POOL - 785268	482,094	5.50	7/01/19	GOVT	1.92	4.52%
	FNMA POOL - 793044	268,124	5.00	8/01/19	GOVT	2.58	4.61%
	FNMA POOL - 793480	285,608	5.00	8/01/19	GOVT	2.58	4.61%
	FNMA POOL - 794330	171,404	5.00	9/01/19	GOVT	2.64	4.61%
	FNMA POOL - 794439	194,269	5.00	10/01/19	GOVT	2.64	4.61%
	INCO LTD	167,989	5.70	10/15/15	BAA3	7.70	5.18%
	MORG_ST_CAP_2003-001- A	297,665	3.58	11/25/15	AAA	0.07	3.56%
	SOUTHWEST AIRLINES	194,806	5.13	3/01/17		N/A	N/A
		<u>3,269,437</u>	<u>4.84</u>			<u>2.50</u>	<u>4.48%</u>
OVER 20 YEARS	AOL TIME WARNER	215,577	7.63	4/15/31	BAA1	12.73	5.76%
	ARC 2002-BC1F A	136,983	2.11	1/25/32	AAA	N/A	N/A
	CITIGROUP INC	121,083	5.85	12/11/34	AA1	14.56	5.15%

VERMONT MUNICIPAL EMPLOYEES

BOND HOLDINGS

AS OF 6/05

SEIX CORE

<u>BOND NAME</u>	<u>MARKET VALUE</u>	<u>COUPON</u>	<u>STATED MATURITY</u>	<u>MOODY RATE</u>	<u>DUR-ATION</u>	<u>YIELD TO MATURITY</u>
COMCAST CORP NEW	29,934	7.05	3/15/33	BAA2	13.32	5.74%
CWABS_HEL_2002-B- A	247,552	3.47	4/15/28	AAA	0.04	3.60%
CWABS_HEL_2002-D- A	98,899	3.46	8/15/28	AAA	0.04	3.59%
DAIMLERCHRYSLER NA CORP	138,462	8.50	1/18/31	A3	12.38	6.37%
DELTA_FND_1999-003- A1F	9,310	7.46	9/15/29	AAA	4.06	7.54%
DEVON FING CORP	86,281	7.88	9/30/31	BAA2	12.74	5.66%
ENTERPRISE PRODUCTS	91,409	6.88	3/01/33	BAA3	13.33	5.93%
EQCC_HEL_1999-003- A7F	23,018	7.45	8/25/29	AAA	1.75	7.53%
EXELON CORP	267,130	5.63	6/15/35	BAA2	14.46	5.57%
FEDERAL NATIONAL MORTGAGE	414,522	5.50	7/14/33	GOVT	N/ A	N/ A
FEDERATED DEPT STORES	52,751	6.90	4/01/29	BAA1	12.43	5.67%
FHLMC	742,100	6.00	7/14/33	GOVT	N/ A	N/ A
FHLMC GOLD POOL - A10098	253,949	5.50	6/01/33	GOVT	2.39	5.01%
FHLMC GOLD POOL - A11080	249,870	5.00	7/01/33	GOVT	3.71	4.97%
FHLMC GOLD POOL - A13482	40,033	6.00	9/01/33	GOVT	1.26	4.54%
FHLMC GOLD POOL - A16521	174,895	6.00	12/01/33	GOVT	1.26	4.54%
FHLMC GOLD POOL - A17597	197,909	6.00	1/01/34	GOVT	1.34	4.64%
FHLMC GOLD POOL - A22067	225,860	6.50	5/01/34	GOVT	0.49	3.92%
FHLMC GOLD POOL - A24756	164,817	6.00	7/01/34	GOVT	1.35	4.64%
FHLMC GOLD POOL - C01672	730,339	6.00	10/01/33	GOVT	1.28	4.54%
FHLMC GOLD POOL - C61720	275,695	6.00	12/01/31	GOVT	1.47	4.67%
FHLMC GOLD POOL - C69011	157,478	6.50	7/01/32	GOVT	0.95	4.39%
FHLMC GOLD POOL - C76371	562,927	5.00	2/01/33	GOVT	3.40	4.97%
FHLMC GOLD POOL - C79584	228,410	5.50	5/01/33	GOVT	2.44	5.01%
FHLMC GOLD TBA 30 YR	405,520	5.50	7/15/33	GOVT	N/ A	N/ A
FHLMC GOLD TBA 30 YR	1,269,619	5.00	7/15/33	GOVT	N/ A	N/ A
FHLMC_T-049- AV	40,918	3.52	12/25/32	GOVT	0.07	3.50%
FLEET_HELOC_2003-001- A	130,721	3.57	1/20/33	AAA	0.06	3.59%

VERMONT MUNICIPAL EMPLOYEES

BOND HOLDINGS

AS OF 6/05

SEIX CORE

<u>BOND NAME</u>	<u>MARKET VALUE</u>	<u>COUPON</u>	<u>STATED MATURITY</u>	<u>MOODY RATE</u>	<u>DUR- ATION</u>	<u>YIELD TO MATURITY</u>
FNMA POOL - 254263	90,765	6.50	4/01/32	GOVT	1.26	4.32%
FNMA POOL - 254767	725,559	5.50	6/01/33	GOVT	2.47	4.98%
FNMA POOL - 535899	97,344	6.00	4/01/31	GOVT	1.78	4.62%
FNMA POOL - 687692	196,113	5.50	3/01/33	GOVT	2.51	4.98%
FNMA POOL - 688251	560,426	5.50	2/01/33	GOVT	2.71	4.98%
FNMA POOL - 689022	498,467	5.00	5/01/33	GOVT	3.66	4.94%
FNMA POOL - 698156	256,616	5.50	4/01/33	GOVT	2.48	4.98%
FNMA POOL - 728734	861,160	5.50	7/01/33	GOVT	2.44	4.98%
FNMA POOL - 743541	706,131	5.50	11/01/33	GOVT	2.16	4.98%
FNMA POOL - 747536	717,184	5.00	11/01/33	GOVT	3.93	4.94%
FNMA POOL - 748109	113,797	6.50	10/01/33	GOVT	0.30	3.74%
FNMA POOL - 751810	90,713	6.50	10/01/33	GOVT	0.41	3.74%
FNMA POOL - 753514	133,336	6.00	11/01/33	GOVT	1.23	4.46%
FNMA POOL - 753994	50,927	6.00	12/01/33	GOVT	1.20	4.46%
FNMA POOL - 755813	60,438	6.50	11/01/33	GOVT	0.41	3.74%
FNMA POOL - 769820	95,921	6.00	3/01/34	GOVT	1.23	4.54%
FNMA POOL - 770327	116,963	6.00	4/01/34	GOVT	1.28	4.54%
FNMA POOL - 770439	97,197	6.00	4/01/34	GOVT	1.25	4.54%
FNMA POOL - 772255	62,840	6.00	11/01/33	GOVT	1.21	4.46%
FNMA POOL - 775075	134,291	6.00	5/01/34	GOVT	1.28	4.54%
FNMA POOL - 787810	159,041	6.50	7/01/34	GOVT	0.33	3.74%
FNMA_2002-T10- IA1	45,690	3.43	6/25/32	AAA	0.08	3.54%
FNMA_2002-T13- A	68,559	3.41	8/25/32	GOVT	0.07	3.46%
GNMA POOL - 604012	696,104	5.50	2/15/33	GOVT	2.98	4.97%
GPHE 2003 1 A	73,350	1.59	4/15/29	AAA	N/A	N/A
HSBC HLDGS PLC 144A	112,465	7.63	5/17/32	AA3	13.19	5.40%
K N CAP TR III	122,841	7.63	4/15/28	BAA3	11.83	6.22%
K N ENERGY	60,948	7.25	3/01/28	BAA2	11.86	5.77%

VERMONT MUNICIPAL EMPLOYEES

BOND HOLDINGS

AS OF 6/05

SEIX CORE

<u>BOND NAME</u>	<u>MARKET VALUE</u>	<u>COUPON</u>	<u>STATED MATURITY</u>	<u>MOODY RATE</u>	<u>DUR-ATION</u>	<u>YIELD TO MATURITY</u>
MELLON_HEL_2001-01- A	128,153	3.50	3/20/27	AAA	0.06	3.75%
NEWS AMER 6.2% 12/15/34	57,819	6.20	12/15/34		N/A	N/A
NEW_CENTURY_1999-NCB- A7	20,765	7.54	9/25/29	AAA	0.78	6.92%
PAC G&E	196,922	6.05	3/01/34	BAA1	13.79	5.35%
SASC_2002-BC3- AMBI	59,179	3.63	6/25/32	N/A	0.07	3.69%
SBC COMMUNICATIONS INC	95,869	6.45	6/15/34	A2	14.24	5.58%
SOUNDVIEW_HEL_2001-01- A	9,624	6.26	4/15/31	AAA	3.87	6.16%
SPRINT CAP CORP	248,879	8.75	3/15/32	BAA3	12.58	5.84%
UNITED STATES TREAS BONDS	4,272,697	5.38	2/15/31	GOVT	14.48	4.22%
VERIZON GLOBAL	149,116	7.75	12/01/30	A2	12.87	5.59%
WASI 2002-HE2 A	195,494	1.78	12/25/32	AAA	N/A	N/A
WASI 2003-HE 1 A1	108,466	1.60	3/25/33	AAA	N/A	N/A
	<u>20,332,137</u>	<u>5.51</u>			<u>6.54</u>	<u>4.70%</u>

VERMONT MUNICIPAL EMPLOYEES

BOND HOLDINGS

AS OF 6/05

SEIX HIGH YIELD

	<u>BOND NAME</u>	<u>MARKET VALUE</u>	<u>COUPON</u>	<u>STATED MATURITY</u>	<u>MOODY RATE</u>	<u>DUR-ATION</u>	<u>YIELD TO MATURITY</u>
0-5 YEARS	ALLEGHENY ENERGY SUPPLY 14	27,808	10.25	11/15/07	B3	2.10	5.68%
	AMERIGAS PARTNERS L P	11,051	10.00	4/15/06	B2	0.75	5.72%
	BALL CORP	1,319	7.75	8/01/06	BA2	1.01	4.41%
	CANANDAIGUA BRANDS INC	46,010	8.63	8/01/06	BA2	1.00	4.79%
	CAPITOL RECORDS INC 144A	65,494	8.38	8/15/09	BA1	3.40	5.95%
	CB RICHARD ELLIS SVCS INC	27,903	9.75	5/15/10	BA3	1.87	5.95%
	CITGO PETE CORP	6,478	7.88	5/15/06	BA2	0.83	4.91%
	CITIZENS COMM	53,953	7.63	8/15/08	BA3	2.70	5.59%
	CSC HLDGS INC	14,914	8.13	7/15/09	B1	3.28	7.76%
	DEAN FOODS CO	89,013	8.15	8/01/07	BA2	1.86	5.33%
	DEX MEDIA EAST LLC/DEX	62,857	9.88	11/15/09	B1	1.32	5.53%
	ECHOSTAR DBS CORP	11,942	9.13	1/15/09	BA3	0.61	5.21%
	EDISON MISSION ENERGY	42,966	7.73	6/15/09	B1	3.39	6.18%
	EDISON MISSION ENERGY	5,607	10.00	8/15/08	B1	2.62	5.66%
	EQUISTAR CHEMICALS	15,835	10.13	9/01/08	B2	2.63	7.16%
	ETHYL CORP	25,721	8.88	5/01/10	B2	3.21	7.76%
	FOREST OIL CORP	50,612	8.00	6/15/08	BA3	2.62	5.76%
	GEORGIA PACIFIC	131,977	8.88	2/01/10	BA2	3.70	5.50%
	GEORGIA PACIFIC	52,916	7.38	7/15/08	BA2	2.64	5.08%
	HCA INC	23,822	5.50	12/01/09	BA2	3.87	5.42%
	HERCULES INC	17,029	11.13	11/15/07	BA2	2.09	5.28%
	HOST MARRIOTT L P	81,526	9.50	1/15/07	BA3	1.38	5.39%
	HOST MARRIOTT L P	26,400	9.25	10/01/07	BA3	2.00	5.42%
	HUNTSMAN INTL LLC	10,635	9.88	3/01/09	B2	0.68	6.35%
	IPALCO ENTERPRISES	54,918	7.38	11/14/08	BA1	2.97	4.85%
	LYONDELL CHEMICAL CO	61,699	9.63	5/01/07	B1	1.66	5.69%
	MANDALAY RESORT GRP	122,850	10.25	8/01/07	BA3	1.82	5.13%
	MCI INC	60,763	5.91	5/01/07	B2	0.82	4.21%

VERMONT MUNICIPAL EMPLOYEES

BOND HOLDINGS

AS OF 6/05

SEIX HIGH YIELD

<u>BOND NAME</u>	<u>MARKET VALUE</u>	<u>COUPON</u>	<u>STATED MATURITY</u>	<u>MOODY RATE</u>	<u>DUR-ATION</u>	<u>YIELD TO MATURITY</u>
MCI INC	22,131	6.69	5/01/09	B2	1.55	4.95%
MGM MIRAGE INC	76,945	9.75	6/01/07	BA3	1.75	5.11%
MIDWEST_GEN_2000- A	36,220	8.30	7/02/09	B1	2.48	5.90%
MILLENNIUM AMER INC	53,783	7.00	11/15/06	B1	1.29	5.28%
NMHG HLDG CO	28,738	10.00	5/15/09	B3	2.23	8.01%
OWENS BROCKWAY GLASS	42,348	8.88	2/15/09	B1	0.98	5.62%
PACIFICARE HEALTH SYS INC	47,947	10.75	6/01/09	BA3	0.87	5.24%
PARK PLACE ENT	88,975	7.50	9/01/09	BAA3	3.53	4.76%
PARK PLACE ENT	20,108	9.38	2/15/07	BA1	1.47	4.53%
PENN NATL GAMING INC	22,087	8.88	3/15/10	B2	0.67	4.91%
PETROLEUM HELICOPTERS INC	26,125	9.38	5/01/09	B1	2.02	7.28%
PREMCO REFNG GROUP	75,491	9.25	2/01/10	BA3	1.48	5.10%
PRIMEDIA INC	10,947	7.63	4/01/08	B2	0.60	6.05%
PSEG ENERGY	12,451	7.75	4/16/07	BA3	1.64	5.81%
PSEG ENERGY HLDGS	143,887	8.63	2/15/08	BA3	2.28	6.01%
PSEG ENERGY HLDGS	10,481	10.00	10/01/09	BA3	3.42	6.64%
ROUSE CO	41,609	8.00	4/30/09	BA1	3.28	5.21%
SALTON SEA FDG CORP	15,493	7.84	5/30/10	BA1	2.53	5.60%
SEAGATE TECHNOLOGY HDD HL	39,947	8.00	5/15/09	BA2	1.20	4.98%
SERVICE CORP INTL	4,221	6.50	3/15/08	BA3	2.42	5.59%
SERVICE CORP INTL	17,582	7.70	4/15/09	BA3	3.24	5.62%
SITHE / INDEPENDENCE FDG C	14,947	8.50	6/30/07	BA2	1.19	6.07%
SMITHFIELD FOODS INC	43,927	8.00	10/15/09	BA2	3.58	5.86%
SWIFT & CO	10,924	12.50	1/01/10	B2	1.19	7.44%
SWIFT & CO	29,111	10.13	10/01/09	B1	1.44	6.46%
TRANSMONTAIGNE OIL CO	15,510	9.13	6/01/10	B3	3.25	7.91%
TXU CORP 144A	33,426	4.80	11/15/09	BA1	3.87	5.27%
UNIVERSAL COMPRESSION	4,634	7.25	5/15/10	BA3	3.06	5.93%

VERMONT MUNICIPAL EMPLOYEES

BOND HOLDINGS

AS OF 6/05

SEIX HIGH YIELD

	<u>BOND NAME</u>	<u>MARKET VALUE</u>	<u>COUPON</u>	<u>STATED MATURITY</u>	<u>MOODY RATE</u>	<u>DUR-ATION</u>	<u>YIELD TO MATURITY</u>
	XEROX CORP	15,615	7.13	6/15/10	BA2	4.16	5.63%
	XEROX CORP	139,500	9.75	1/15/09	BA2	2.92	5.46%
		<u>2,349,129</u>	<u>8.68</u>			<u>2.26</u>	<u>5.54%</u>
5-10 YEARS	AES CORP	26,783	9.38	9/15/10	B1	4.08	6.34%
	AES CORP 144A	124,075	8.75	5/15/13	BA3	2.75	5.68%
	AINSWORTH LMBR LTD	13,497	6.75	3/15/14	B2	6.27	8.22%
	ALLEGHENY ENERGY SUPPLY	114,683	8.25	4/15/12	BA3	5.19	6.06%
	ALLEGHENY ENERGY SUPPLY	16,389	7.80	3/15/11	BA3	4.53	5.92%
	APPLETON PAPERS INC	36,833	8.13	6/15/11	B2	4.44	8.67%
	APPLETON PAPERS INC	14,991	9.75	6/15/14	B3	5.59	10.36%
	AQUILA INC	71,376	11.88	7/01/12	B2	4.85	6.33%
	ARGOSY GAMING CO	90,488	9.00	9/01/11	BA3	1.09	4.46%
	BCP CRYSTAL US HLDGS	36,077	9.63	6/15/14	B3	3.95	7.16%
	BEAR CREEK CORP 144A	15,057	9.00	3/01/13	B3	4.96	9.46%
	BERRY PLASTICS	22,693	10.75	7/15/12	B3	2.44	8.27%
	BOISE CASCADE CORP 144A	26,190	7.13	10/15/14	B2	6.14	7.39%
	BOYD GAMING CORP	1,097	6.75	4/15/14	B1	5.43	6.29%
	CABLEVISION SYS CORP	34,265	8.00	4/15/12	B3	5.06	8.39%
	CANWEST MEDIA INC	39,015	7.63	4/15/13	BA3	3.59	6.13%
	CARTER WILLIAM CO	12,092	10.88	8/15/11	B3	1.03	4.55%
	CASELLA WASTE SYSTEMS	22,294	9.75	2/01/13	B3	3.26	7.93%
	CB RICHARD ELLIS SVCS INC	36,943	11.25	6/15/11	B1	0.91	5.14%
	CHC HELICOPTER CORP 144A	23,387	7.38	5/01/14	B2	5.74	7.41%
	CHC HELICOPTER CORP	25,237	7.38	5/01/14	B2	5.74	7.41%
	CHESAPEAKE ENERGY CORP	29,339	7.75	1/15/15	BA3	3.06	5.76%
	CHESAPEAKE ENERGY CORP	39,805	7.50	6/15/14	BA3	4.50	5.91%
	CHESAPEAKE ENERGY CORP	129,458	7.50	9/15/13	BA3	3.71	5.73%

VERMONT MUNICIPAL EMPLOYEES

BOND HOLDINGS

AS OF 6/05

SEIX HIGH YIELD

<u>BOND NAME</u>	<u>MARKET VALUE</u>	<u>COUPON</u>	<u>STATED MATURITY</u>	<u>MOODY RATE</u>	<u>DUR-ATION</u>	<u>YIELD TO MATURITY</u>
CHESAPEAKE ENERGY CORP 14	39,391	6.38	6/15/15	BA3	6.11	5.95%
CHUMASH CASINO & RESORT E	33,909	9.00	7/15/10	BA3	1.01	5.03%
CITIZENS COMM	28,058	6.25	1/15/13	BA3	5.67	6.81%
CITIZENS COMM	121,979	9.25	5/15/11	BA3	4.53	6.81%
CO INTERSTATE GAS 144A	9,899	5.95	3/15/15	B1	7.14	6.14%
CONSOLIDATED COMM 144A	20,555	9.75	4/01/12	B3	3.82	8.51%
CORRECTIONS CORP AMER	82,100	7.50	5/01/11	B1	3.21	6.27%
CORRECTIONS CORP AMER	29,239	6.25	3/15/13	B1	5.38	6.38%
COUCHE TARD US LP	33,930	7.50	12/15/13	BA3	4.75	6.54%
COVENTRY HEALTH CARE	60,308	8.13	2/15/12	BA1	1.71	5.34%
CROWN EUROPEAN HLDGS	39,658	10.88	3/01/13	B2	2.28	5.63%
CRUM & FOSTER HLDGS CORP	29,796	10.38	6/15/13	BA3	5.45	8.86%
DAVITA INC 144A	43,047	6.63	3/15/13	B2	4.91	5.94%
DAVITA INC 144A	62,006	7.25	3/15/15	B3	5.92	6.78%
DEL MONTE CORPORATION	12,637	8.63	12/15/12	B2	2.53	5.85%
DEX MEDIA INC	9,437	0.00	11/15/13	B3	5.15	7.63%
DEX MEDIA INC	7,098	0.00	11/15/13	B3	5.89	7.19%
DEX MEDIA WEST LLC	121,402	9.88	8/15/13	B2	2.76	6.32%
DEX MEDIA WEST LLC	28,222	8.50	8/15/10	B1	2.42	5.84%
DIRECTV HLDGS	123,620	8.38	3/15/13	BA2	2.64	5.50%
DYNEGY INC	46,006	10.13	7/15/13	B3	2.76	6.84%
ECHOSTAR DBS CORP	104,935	6.38	10/01/11	BA3	5.01	6.54%
EDISON MISSION ENERGY	98,201	9.88	4/15/11	B1	4.44	6.30%
ELIZABETH ARDEN INC	36,663	7.75	1/15/14	B2	4.83	6.93%
ENCORE ACQUISITION	20,428	8.38	6/15/12	B2	2.16	5.77%
EQUISTAR CHEMICALS	11,251	10.63	5/01/11	B2	2.11	7.23%
EXCO RESOURCES	29,388	7.25	1/15/11	B2	3.67	7.25%
FAIRFAX FINL HLDGS	1,598	7.75	4/26/12	BA3	5.09	8.73%

VERMONT MUNICIPAL EMPLOYEES

BOND HOLDINGS

AS OF 6/05

SEIX HIGH YIELD

<u>BOND NAME</u>	<u>MARKET VALUE</u>	<u>COUPON</u>	<u>STATED MATURITY</u>	<u>MOODY RATE</u>	<u>DUR- ATION</u>	<u>YIELD TO MATURITY</u>
FERRELLGAS LP	6,699	6.75	5/01/14	BA3	6.11	7.29%
FERRELLGAS PARTNERS L P/F	41,835	8.75	6/15/12	B2	4.49	8.75%
FIRSTENERGY CORP	31,854	6.45	11/15/11	BAA3	5.22	4.75%
FOREST OIL CORP	43,976	8.00	12/15/11	BA3	5.07	6.06%
GAYLORD ENTERTAINMENT	16,396	8.00	11/15/13	B3	6.05	7.17%
GENERAL CABLE CORP	48,079	9.50	11/15/10	B2	4.16	7.87%
GEO GROUP INC	34,577	8.25	7/15/13	B1	5.26	8.87%
GEORGIA PACIFIC	26,772	9.50	12/01/11	BA3	4.93	5.60%
GEORGIA PACIFIC	48,008	8.13	5/15/11	BA3	4.69	5.55%
GEORGIA PACIFIC	1,441	9.38	2/01/13	BA2	2.28	5.56%
GOLD KIST INC	26,781	10.25	3/15/14	B2	5.75	8.13%
GRAPHIC PKG INTL	11,040	9.50	8/15/13	B3	4.86	9.33%
GRAY TELEVISION INC	38,268	9.25	12/15/11	B1	1.54	6.14%
HANOVER COMPRESSOR	19,350	8.63	12/15/10	B3	3.48	7.10%
HANOVER COMPRESSOR	18,781	9.00	6/01/14	B3	4.80	7.77%
HANOVER EQUIP TR 2001A	38,677	8.75	9/01/11	B2	1.92	6.75%
HCA INC	58,906	7.88	2/01/11	BA2	4.42	5.75%
HCA INC	76,613	8.75	9/01/10	BA2	4.11	5.66%
HCA INC	12,556	6.30	10/01/12	BA2	5.70	5.84%
HOST MARRIOTT L P 144A	27,349	6.38	3/15/15	BA3	6.43	6.51%
HOUGHTON MIFFLIN CO	46,270	8.25	2/01/11	B3	3.03	7.04%
HUNTSMAN LLC	52,951	11.63	10/15/10	B1	2.00	5.92%
INERGY LTD PARTNERS 144A	35,242	6.88	12/15/14	B1	6.42	7.28%
INMARSAT FIN PLC	78,324	7.63	6/30/12	B2	3.76	6.45%
INSIGHT MIDWEST LP	22,205	10.50	11/01/10	B2	0.96	7.68%
INTELSAT LTD 144A	13,712	8.63	1/15/15	B2	5.25	7.65%
INTELSAT LTD 144A	133,246	8.25	1/15/13	B2	4.57	7.52%
ISLE CAPRI CASINOS INC	29,987	9.00	3/15/12	B2	1.79	6.06%

VERMONT MUNICIPAL EMPLOYEES

BOND HOLDINGS

AS OF 6/05

SEIX HIGH YIELD

<u>BOND NAME</u>	<u>MARKET VALUE</u>	<u>COUPON</u>	<u>STATED MATURITY</u>	<u>MOODY RATE</u>	<u>DUR-ATION</u>	<u>YIELD TO MATURITY</u>
JOSTENS INC	27,280	7.63	10/01/12	B3	4.92	7.85%
KABEL DEUTSCHLAND GMBH 14	49,494	10.63	7/01/14	B2	4.25	8.90%
KINETIC CONCEPTS	23,979	7.38	5/15/13	B2	4.34	6.44%
KOPPERS INC	35,516	9.88	10/15/13	B2	5.60	8.51%
L-3 COMMUNICATIONS CORP	36,184	7.63	6/15/12	BA3	2.75	5.92%
LEUCADIA NATL 144A	40,418	7.00	8/15/13	BA2	5.96	7.00%
LUSCAR COAL LTD	41,847	9.75	10/15/11	BA3	1.20	5.32%
LYONDELL CHEM WW	49,954	10.25	11/01/10	B1	4.08	7.91%
MARKWEST ENERGY PART 144A	18,713	6.88	11/01/14	B1	6.13	6.95%
MCI INC	217,255	7.73	5/01/14	B2	3.58	5.02%
MERITAGE CORP	10,576	6.25	3/15/15	BA3	6.71	7.00%
MGM MIRAGE INC	184,366	8.50	9/15/10	BA2	4.15	6.01%
MILLAR WESTN FST PRODS	32,445	7.75	11/15/13	B2	5.78	8.82%
MSW ENERGY HLDGS	47,970	8.50	9/01/10	BA3	3.15	6.89%
MSW ENERGY HLDGS	66,254	7.38	9/01/10	BA3	3.58	6.67%
NALCO CO	89,130	7.75	11/15/11	B2	3.24	6.04%
NEENAH PAPER INC 144A	22,396	7.38	11/15/14	B1	6.24	7.83%
NEXTEL COMM INC	114,446	6.88	10/31/13	BA3	4.14	5.43%
NEXTEL COMM INC	62,791	5.95	3/15/14	BA3	5.10	5.25%
NRG ENERGY INC 144A	32	8.00	12/15/13	B1	4.65	6.93%
OMEGA HEALTHCARE	23,313	7.00	4/01/14	B1	6.37	6.88%
OWENS BROCKWAY GLASS	17,495	8.25	5/15/13	B2	3.35	6.25%
OWENS BROCKWAY GLASS	71,702	8.75	11/15/12	B1	2.37	5.81%
PANAMSAT CORP NEW	30,424	9.00	8/15/14	B1	4.44	7.32%
PANTRY INC	32,939	7.75	2/15/14	B3	5.23	7.36%
PENN NATL GAMING INC 144A	16,188	6.75	3/01/15	B3	6.31	6.86%
PILGRIMS PRIDE CORP	19,934	9.63	9/15/11	BA2	1.12	5.50%
PLASTIPAK HLDGS INC	16,296	10.75	9/01/11	B3	1.07	6.03%

VERMONT MUNICIPAL EMPLOYEES

BOND HOLDINGS

AS OF 6/05

SEIX HIGH YIELD

<u>BOND NAME</u>	<u>MARKET VALUE</u>	<u>COUPON</u>	<u>STATED MATURITY</u>	<u>MOODY RATE</u>	<u>DUR-ATION</u>	<u>YIELD TO MATURITY</u>
PQ CORP 144A	19,480	7.50	2/15/13	B3	5.15	7.81%
PREMCOR REFNG GROUP	33,875	6.75	2/01/11	BA3	4.55	5.09%
PREMCOR REFNG GROUP	27,864	6.13	5/01/11	BA3	4.85	5.02%
PREMCOR REFNG GROUP	58,523	7.75	2/01/12	B2	2.84	5.29%
PREMCOR REFNG GROUP	54,918	6.75	5/01/14	BA3	4.48	5.29%
PRIMEDIA INC	23,352	8.88	5/15/11	B2	2.38	7.44%
PRIMEDIA INC	52,833	8.00	5/15/13	B2	5.71	7.95%
QUEBECOR MEDIA INC	43,215	11.13	7/15/11	B2	0.94	5.27%
QWEST CORP	31,307	6.69	6/15/13	BA3	0.34	6.36%
QWEST CORP 144A	9,589	8.88	3/15/12	BA3	4.97	7.20%
QWEST CORP 144A	97,661	7.88	9/01/11	BA3	4.75	7.01%
R H DONNELLEY CORP	101,745	10.88	12/15/12	B2	2.18	5.78%
R H DONNELLEY CORP	41,914	10.88	12/15/12	B2	2.18	5.78%
RADIO ONE INC	29,826	8.88	7/01/11	B2	0.99	5.58%
RAINBOW NATL SVCS 144A	76,152	8.75	9/01/12	B3	3.58	6.60%
READERS DIGEST ASSN	63,900	6.50	3/01/11	BA2	4.10	6.12%
RELIANT RES INC	31,667	9.25	7/15/10	B1	2.42	6.61%
ROCKWOOD SPECIALTIES	40,515	10.63	5/15/11	B3	1.92	7.36%
ROCKWOOD SPECIALTIES 144A	44,060	7.50	11/15/14	B3	6.08	7.61%
ROGERS WIRELESS	60,262	6.38	3/01/14	BA3	6.48	6.11%
ROUSE CO	27,188	7.20	9/15/12	BA1	5.54	5.86%
SITHE / INDEPENDENCE FDG C	91,013	9.00	12/30/13	BA2	4.52	7.37%
SMITHFIELD FOODS INC	55,778	7.75	5/15/13	BA2	5.89	6.28%
SUBURBAN PROPANE PART 144A	53,213	6.88	12/15/13	B1	6.01	7.69%
SYBRON DENTAL SPECIALTIES	28,272	8.13	6/15/12	B1	2.66	6.25%
TEXAS GENCO LLC 144A	130,194	6.88	12/15/14	B1	5.53	5.99%
TRANSCONTINENTAL GAS PIPE	12,312	8.88	7/15/12	BA2	5.21	5.58%
TRIAD HOSPS INC	66,577	7.00	5/15/12	B2	4.12	5.98%

VERMONT MUNICIPAL EMPLOYEES

BOND HOLDINGS

AS OF 6/05

SEIX HIGH YIELD

	<u>BOND NAME</u>	<u>MARKET VALUE</u>	<u>COUPON</u>	<u>STATED MATURITY</u>	<u>MOODY RATE</u>	<u>DUR-ATION</u>	<u>YIELD TO MATURITY</u>
	TXU CORP 144A	65,646	5.55	11/15/14	BA1	7.14	5.97%
	UNITED AGRI PRODUCST	32,232	8.25	12/15/11	B1	4.96	7.55%
	UNITED AUTO GROUP INC	7,487	9.63	3/15/12	B3	2.68	7.86%
	UNITED RENTALS NA	13,789	6.50	2/15/12	B1	4.69	6.81%
	US CONCRETE	20,458	8.38	4/01/14	B3	5.88	9.39%
	UTILICORP UNITED	24,719	7.95	2/01/11	B2	4.40	6.13%
	VALOR TELECOMM ENT 144A	31,849	7.75	2/15/15	B1	6.09	8.01%
	WARNER MUSIC GROUP	68,075	7.38	4/15/14	B3	5.56	7.18%
	WILLIAMS COS	167,284	7.13	9/01/11	B1	4.90	5.57%
	WILLIAMS COS	71,964	8.13	3/15/12	B1	5.15	5.67%
	WYNN LAS VEGAS LLC/CAP 14	126,990	6.63	12/01/14	B2	6.44	7.03%
	XEROX CORP	36,900	6.88	8/15/11	BA2	4.88	5.70%
		<u>6,800,655</u>	<u>8.19</u>			<u>4.13</u>	<u>6.42%</u>
10-20 YEARS	AES RED OAK L L C *	18,060	8.54	11/30/19	B2	7.73	7.19%
	CHESAPEAKE ENERGY CORP	8,502	6.88	1/15/16	BA3	5.18	6.08%
	CROWN CORK & SEAL CO	7,752	8.00	4/15/23	B3	6.62	8.27%
	CSC HLDGS INC	6,476	7.88	2/15/18	B1	7.63	8.06%
	CSC HLDGS INC	17,952	7.63	7/15/18	B1	7.77	8.06%
	FAIRFAX FINL HLDGS	6,167	7.38	4/15/18	BA3	7.56	9.49%
	FPL ENERGY NAT WIN 144A	23,744	6.13	3/25/19	BA2	8.90	6.45%
	FPL ENERGY WIND FDG 144A	32,772	6.88	6/27/17	BA2	8.27	6.63%
	HOMER CITY FDG LLC	29,867	8.14	10/01/19	BA2	5.74	6.14%
	MIDWEST_GEN_2000- B	122,311	8.56	1/02/16	B1	4.93	6.57%
	NEXTEL COMM INC	114,726	7.38	8/01/15	BA3	3.73	5.56%
	SALTON SEA FDG CORP	13,932	7.47	11/30/18	BA1	6.74	6.04%
		<u>402,261</u>	<u>7.75</u>			<u>5.59</u>	<u>6.42%</u>

VERMONT MUNICIPAL EMPLOYEES

BOND HOLDINGS

AS OF 6/05

SEIX HIGH YIELD

	<u>BOND NAME</u>	<u>MARKET VALUE</u>	<u>COUPON</u>	<u>STATED MATURITY</u>	<u>MOODY RATE</u>	<u>DUR- ATION</u>	<u>YIELD TO MATURITY</u>
OVER 20 YEARS	AES RED OAK L L C *	25,454	9.20	11/30/29	B2	9.91	7.99%
	AFC CAP TR I	44,041	8.21	2/03/27	BA2	10.34	7.00%
	ALLMERICA FINL CORP	17,258	7.65	10/15/25	BA1	10.46	6.74%
	AT&T CORP	248,179	9.75	11/15/31	BA1	10.96	7.19%
	CITIZENS COMM	21,106	9.00	8/15/31	BA3	9.74	8.75%
	COLUMBIA/HCA HEALTHCARE	63,441	7.50	11/15/95	BA2	12.75	7.72%
	EL PASO NAT GAS	19,205	8.38	6/15/32	B1	11.53	7.02%
	FAIRFAX FINL HLDGS	3,966	8.30	4/15/26	BA3	8.73	9.96%
	FAIRFAX FINL HLDGS	9,927	7.75	7/15/37	BA3	9.39	9.87%
	FIRSTENERGY CORP	10,093	7.38	11/15/31	BAA3	12.91	5.73%
	GEORGIA PACIFIC	55,681	8.88	5/15/31	BA3	11.27	6.89%
	HCA INC	43,032	7.50	11/06/33	BA2	11.99	6.89%
	HOMER CITY FUND	42,979	8.73	10/01/26	BA2	10.15	7.16%
	LEUCADIA NATL	1,417	8.65	1/15/27	BA3	5.24	8.24%
	LUCENT TECHNOLOGIES	37,953	6.45	3/15/29	B1	11.08	7.39%
	MARKEL CAP TR I	45,494	8.71	1/01/46	BA1	1.37	4.02%
	MARKEL CORP	19,556	7.35	8/15/34	BAA3	12.91	6.42%
	MIDWEST GENERATION LLC /	7,832	8.75	5/01/34	B1	3.76	6.21%
	SOUTHERN NATURAL GAS	15,825	8.00	3/01/32	B1	11.46	6.87%
	TENNESSEE GAS PIPELINE	10,016	8.38	6/15/32	B1	11.61	6.92%
	US WEST COMM	697	7.20	11/10/26	BA3	9.19	8.20%
	US WEST COMM	19,858	7.25	10/15/35	BA3	10.22	8.27%
	WILLIAMS COS	6,575	7.75	6/15/31	B1	11.62	6.90%
	WILLIAMS COS	121,337	8.75	3/15/32	B1	11.17	7.06%
	XEROX CAP TRUST I	15,298	8.00	2/01/27	BA3	3.96	7.11%
		<u>906,220</u>	<u>8.62</u>			<u>10.43</u>	<u>7.08%</u>

VERMONT MUNICIPAL EMPLOYEES

TOTAL PUBLIC FUNDS - EQUITY COMMITMENT

ASSET ALLOCATION HISTORY

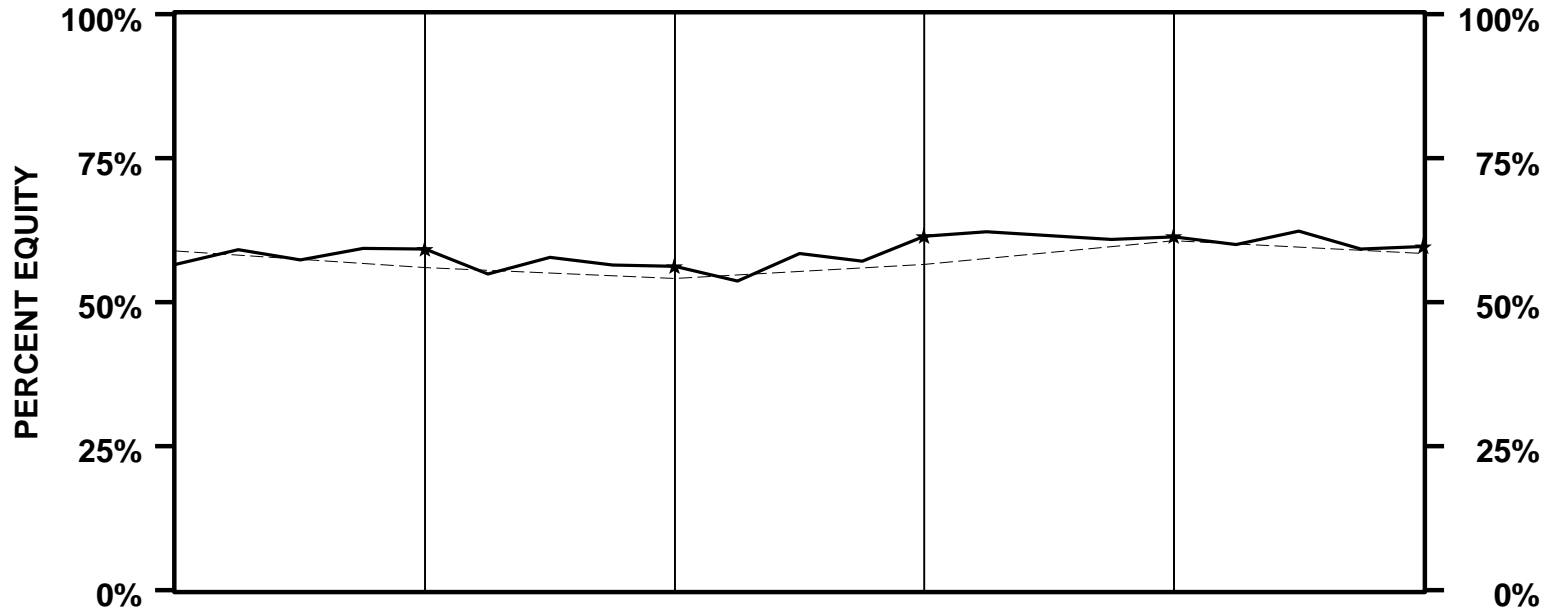

	6/00		6/01		6/02		6/03		6/04		6/05	
HIGH	71.8		70.3		67.7		70.8		72.6		70.7	
1ST QTL	63.9		60.3		58.2		62.2		64.8		63.8	
■ MEDIAN	58.9		56.0		54.1		56.6		60.7		58.5	
3RD QTL	51.9		46.9		45.5		48.5		53.5		51.5	
LOW	0.0		0.0		0.0		0.0		0.0		0.0	
★ MUNI COMPOSITE	56.6	63	59.2	31	56.2	37	61.5	26	61.4	46	59.7	43

* Includes International Segment

VERMONT MUNICIPAL EMPLOYEES

TOTAL PUBLIC FUNDS - BOND COMMITMENT

ASSET ALLOCATION HISTORY

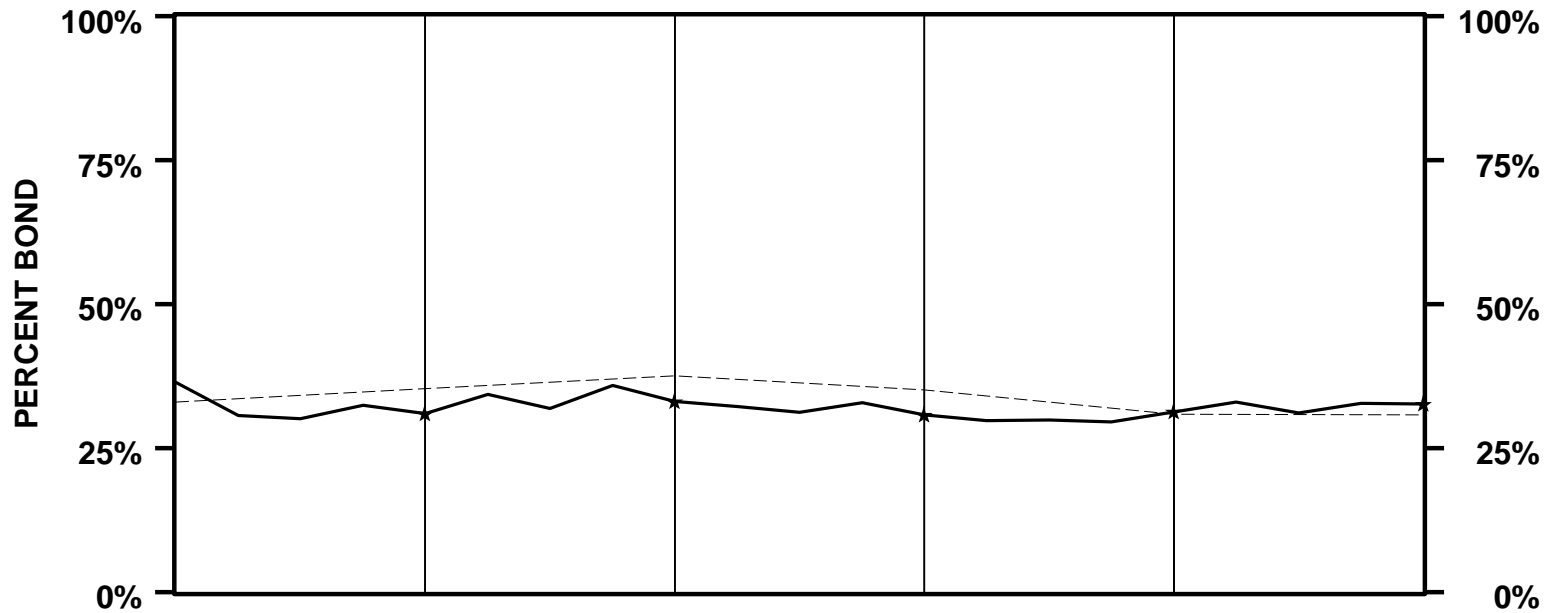

	6/00	6/01	6/02	6/03	6/04	6/05
HIGH	68.2	65.2	65.3	65.2	56.9	55.2
1ST QTL	39.2	41.0	43.7	42.8	36.8	36.9
■ MEDIAN	33.0	35.4	37.6	35.1	30.9	30.8
3RD QTL	25.7	27.1	28.5	28.7	25.9	25.4
LOW	0.0	0.0	0.0	4.0	0.0	0.0
★ MUNI COMPOSITE	36.5	31.0	33.1	30.8	31.3	32.7
	33	63	62	66	48	41

* Includes International Segment

VERMONT MUNICIPAL EMPLOYEES

BOND LARGE FUNDS - BOND COMMITMENT

ASSET ALLOCATION HISTORY

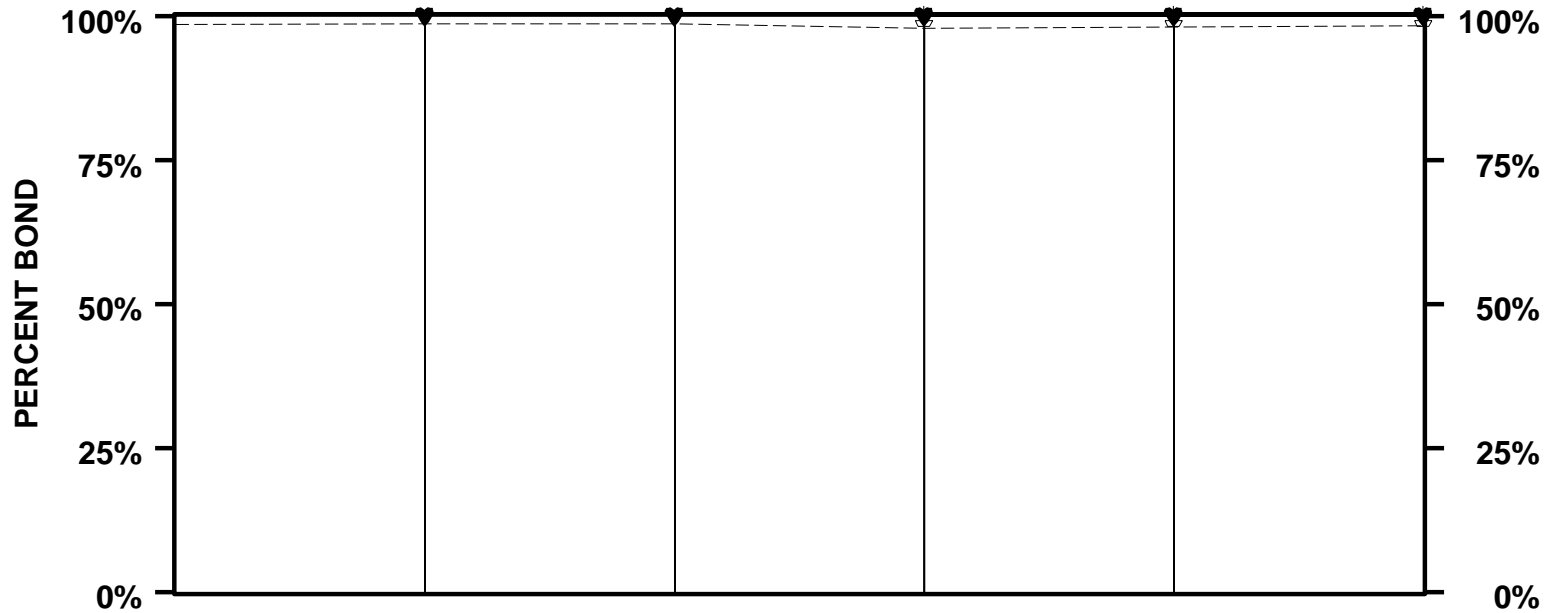

	6/00	6/01	6/02	6/03	6/04	6/05
HIGH	100.0	100.0	100.0	100.0	100.0	100.0
1ST QTL	100.0	100.0	100.0	100.0	100.0	100.0
MEDIAN	98.6	98.7	98.7	97.9	98.2	98.4
3RD QTL	90.5	92.4	92.5	92.7	93.4	95.4
LOW	11.3	34.4	0.0	16.3	0.0	0.0
♥ SEIX CORE	100.0	2	100.0	1	100.0	1
⚡ SEIX HIGH YIELD				100.0	1	100.0

* Includes International Segment

VERMONT MUNICIPAL EMPLOYEES

BOND PUBLIC FUNDS - BOND COMMITMENT

ASSET ALLOCATION HISTORY

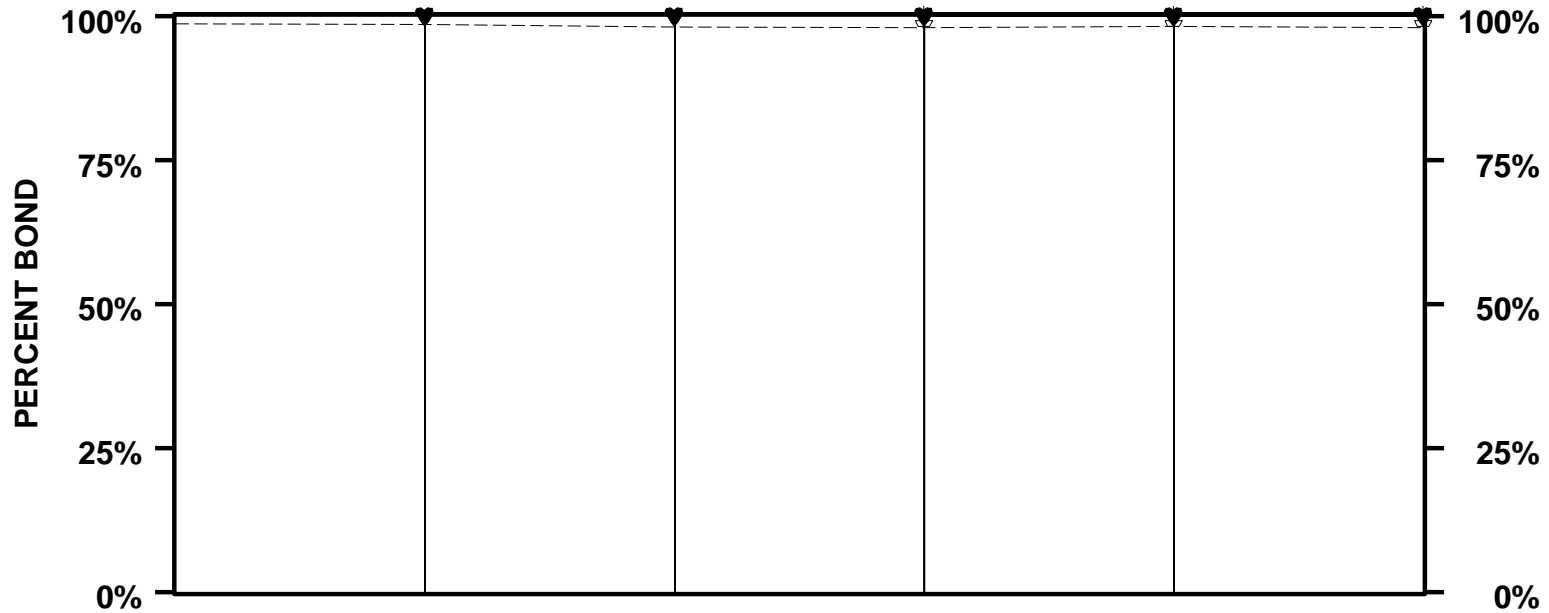

	6/00	6/01	6/02	6/03	6/04	6/05
HIGH	100.0	100.0	100.0	100.0	100.0	100.0
1ST QTL	100.0	100.0	100.0	100.0	100.0	100.0
MEDIAN	98.7	98.6	98.1	98.0	98.3	98.0
3RD QTL	94.9	95.1	94.0	92.0	94.6	91.6
LOW	0.0	34.4	43.4	13.5	23.9	0.0
♥ SEIX CORE	100.0	100.0	100.0	100.0	100.0	100.0
⚡ SEIX HIGH YIELD				100.0	100.0	100.0

* Includes International Segment

VERMONT MUNICIPAL EMPLOYEES

TOTAL PUBLIC FUNDS - TOTAL RATES OF RETURN

PERIODS ENDING 6/05

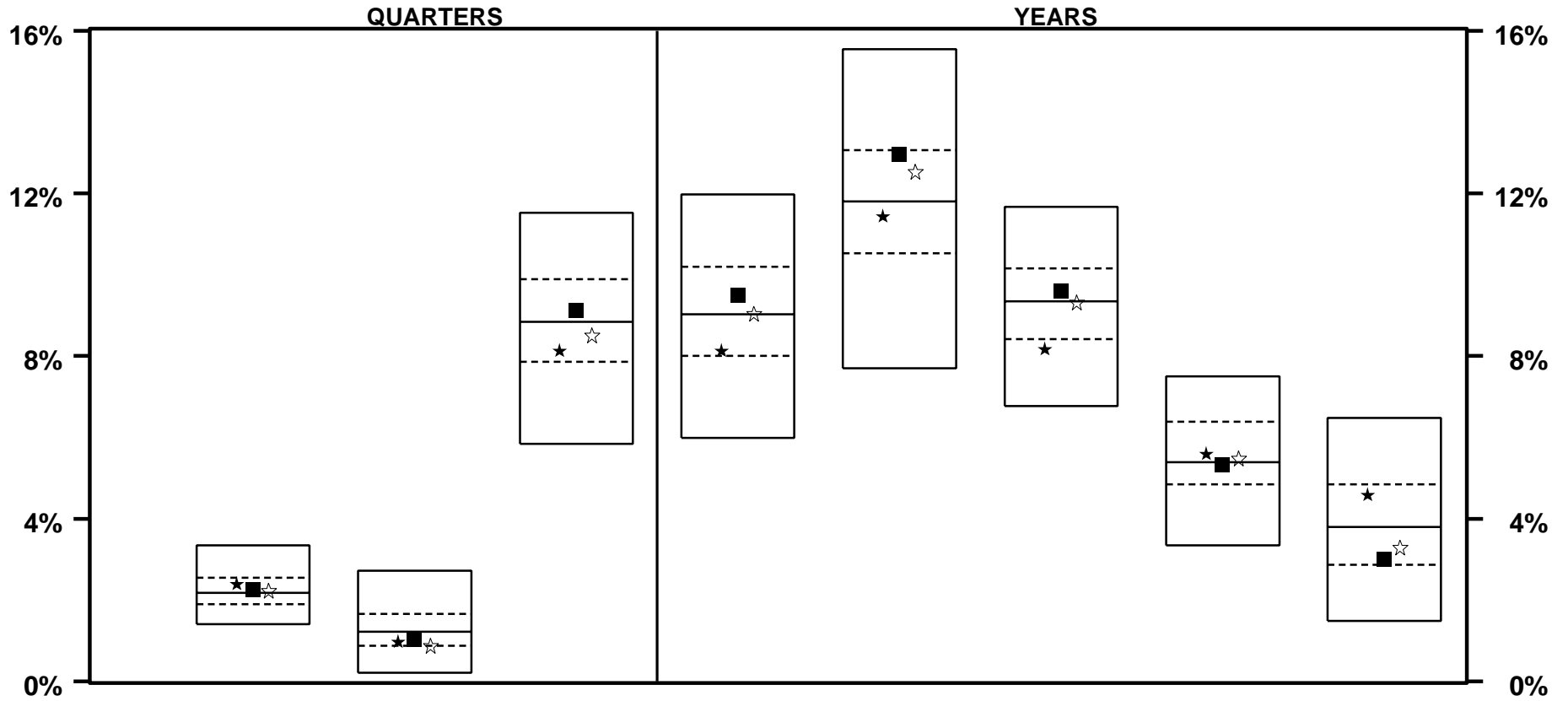

	LAST QTR		LAST 2 QTRS		LAST 3 QTRS		LAST YEAR		LAST 2 YEARS		LAST 3 YEARS		LAST 4 YEARS		LAST 5 YEARS	
★ MUNI COMPOSITE	2.4	33	1.0	71	8.1	71	8.1	71	11.4	58	8.2	79	5.6	41	4.6	31
■ ALLOC INDEX	2.3	43	1.0	67	9.1	42	9.5	39	13.0	27	9.6	39	5.3	51	3.0	70
☆ POLICY INDEX	2.2	44	0.9	74	8.5	62	9.1	48	12.5	33	9.3	50	5.5	46	3.3	63
MEDIAN	2.2		1.2		8.8		9.0		11.8		9.3		5.4		3.8	

VERMONT MUNICIPAL EMPLOYEES

TOTAL PUBLIC FUNDS - TOTAL RATES OF RETURN

PERIODS ENDING 6/05

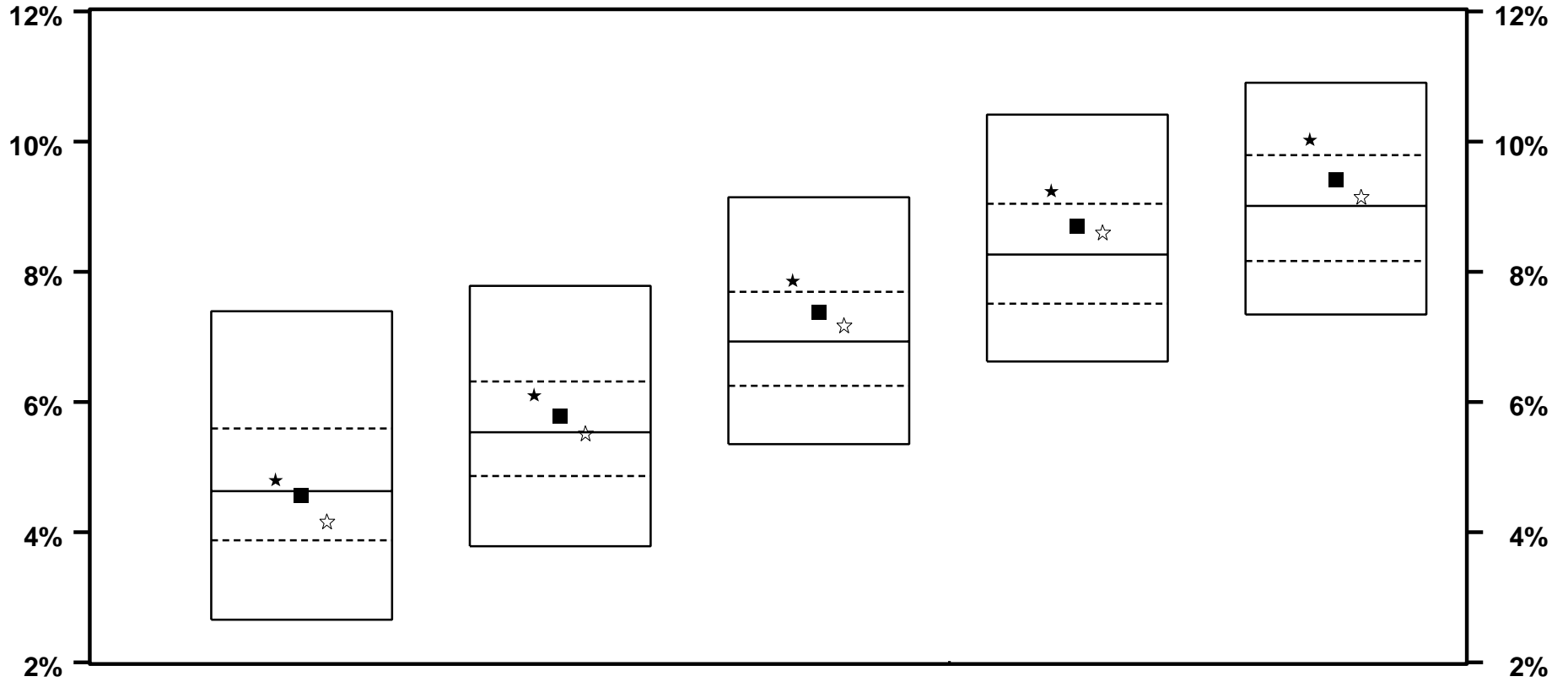

	LAST 6 YEARS		LAST 7 YEARS		LAST 8 YEARS		LAST 9 YEARS		LAST 10 YEARS	
★ MUNI COMPOSITE	4.8	46	6.1	33	7.9	21	9.2	19	10.0	15
■ ALLOC INDEX	4.6	51	5.8	41	7.4	35	8.7	33	9.4	39
☆ POLICY INDEX	4.2	68	5.5	50	7.2	42	8.6	38	9.2	46
MEDIAN	4.6		5.5		6.9		8.3		9.0	

VERMONT MUNICIPAL EMPLOYEES

TOTAL PUBLIC FUNDS - TOTAL RATES OF RETURN

YEARS ENDING

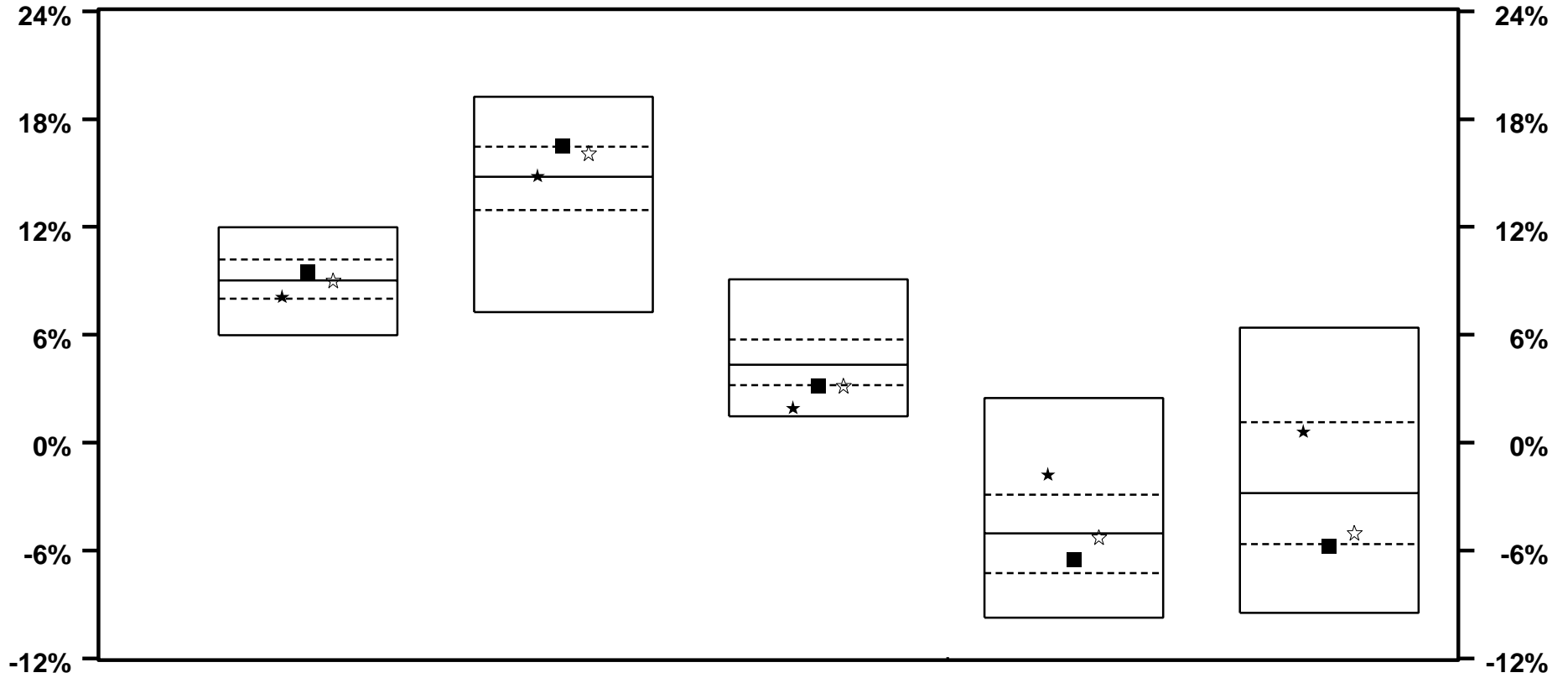

	6 / 05		6 / 04		6 / 03		6 / 02		6 / 01	
★ MUNI COMPOSITE	8.1	71	14.8	49	1.9	92	-1.8	13	0.6	26
■ ALLOC INDEX	9.5	39	16.5	23	3.2	75	-6.5	68	-5.7	76
☆ POLICY INDEX	9.1	48	16.1	30	3.2	75	-5.3	53	-5.0	69
MEDIAN	9.0		14.8		4.3		-5.0		-2.8	

VERMONT MUNICIPAL EMPLOYEES

TOTAL PUBLIC FUNDS - TOTAL RATES OF RETURN

YEARS ENDING

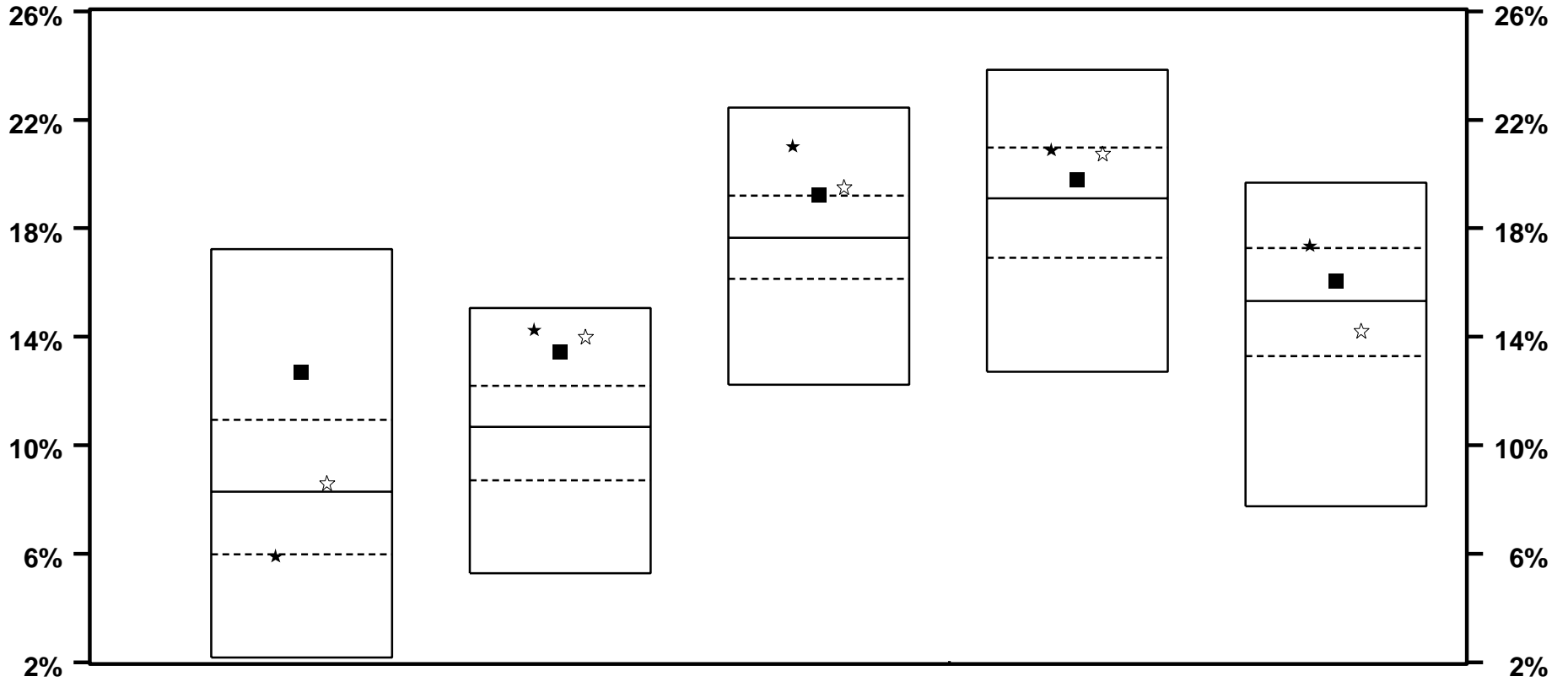

	6 / 00		6 / 99		6 / 98		6 / 97		6 / 96	
★ MUNI COMPOSITE	5.9	75	14.3	7	21.0	11	20.9	26	17.4	23
■ ALLOC INDEX	12.7	12	13.4	10	19.2	24	19.8	38	16.0	39
☆ POLICY INDEX	8.6	46	14.0	9	19.5	19	20.8	27	14.2	65
MEDIAN	8.3		10.7		17.7		19.1		15.3	

VERMONT MUNICIPAL EMPLOYEES

TOTAL PUBLIC FUNDS - TOTAL RETURN VS RISK

3 YEARS ENDING 6/05

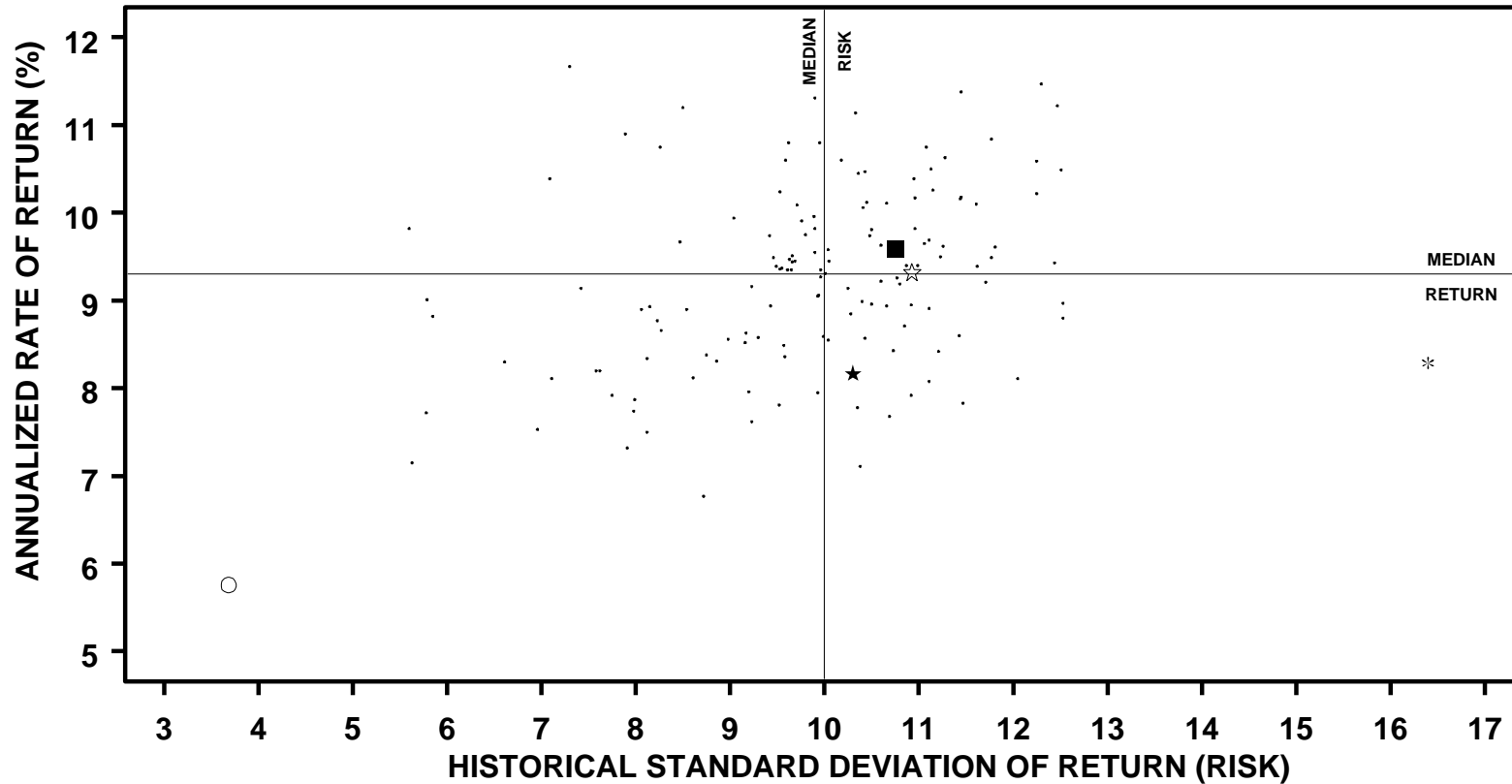

	ANNUALIZED RETURN		STANDARD DEVIATION		SHARPE RATIO	
	VALUE	RANK	VALUE	RANK	VALUE	RANK
★ MUNI COMPOSITE	8.2	79	10.3	43	0.7	88
■ ALLOC INDEX	9.6	39	10.8	32	0.8	61
☆ POLICY INDEX	9.3	50	10.9	28	0.7	71
* S&P 500	8.3	78	16.4	1	0.5	100
○ LB AGGREGATE	5.8	99	3.7	99	1.1	6
MEDIAN	9.3		10.0		0.8	

VERMONT MUNICIPAL EMPLOYEES

TOTAL PUBLIC FUNDS - TOTAL RETURN VS RISK

5 YEARS ENDING 6/05

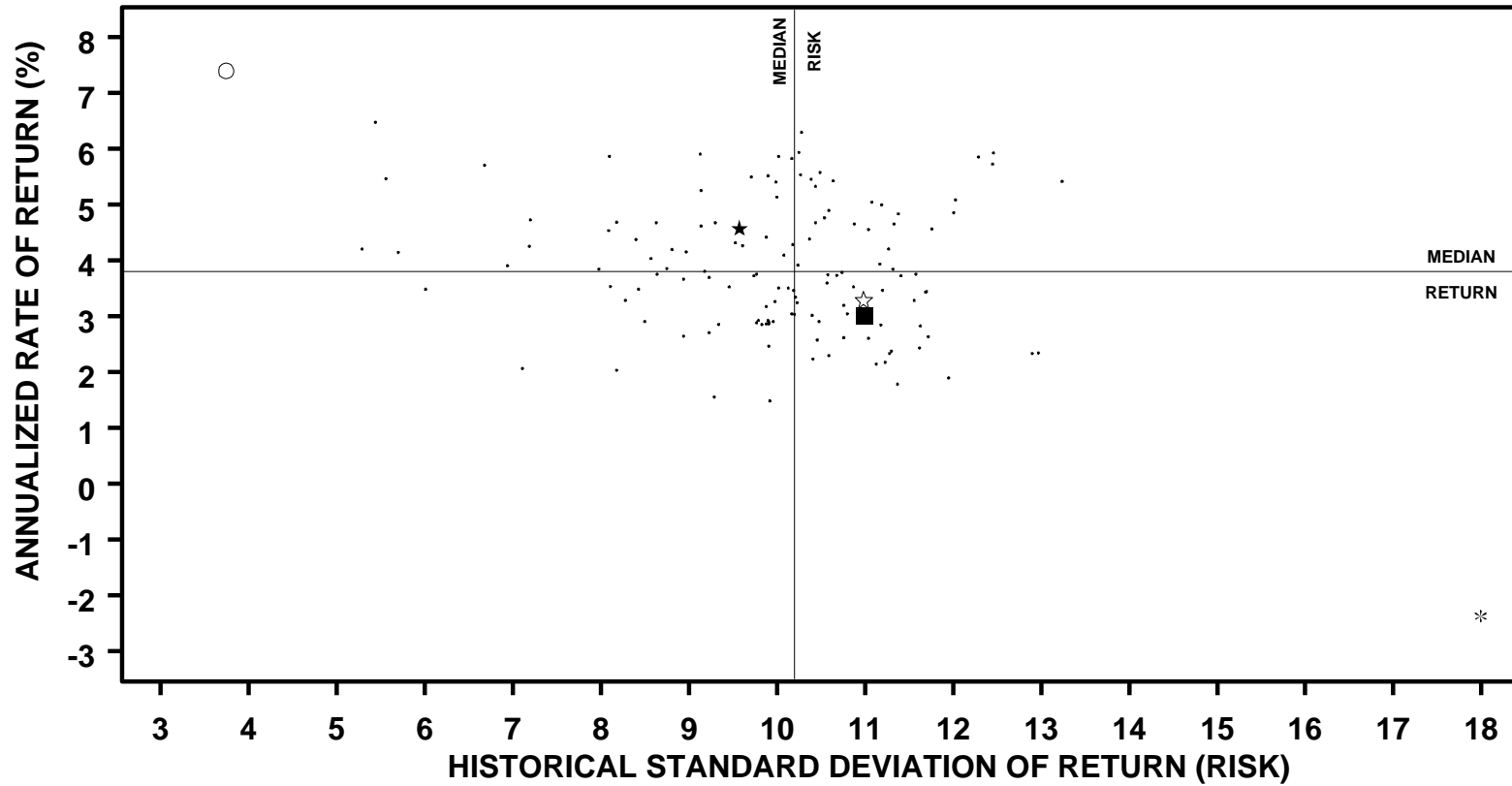

	ANNUALIZED RETURN		STANDARD DEVIATION		SHARPE RATIO	
	VALUE	RANK	VALUE	RANK	VALUE	RANK
★ MUNI COMPOSITE	4.6	31	9.6	67	0.2	31
■ ALLOC INDEX	3.0	70	11.0	29	0.1	68
☆ POLICY INDEX	3.3	63	11.0	29	0.1	64
* S&P 500	-2.4	100	18.0	1	-0.2	
○ LB AGGREGATE	7.4	2	3.8	99	1.2	1
MEDIAN	3.8		10.2		0.2	

VERMONT MUNICIPAL EMPLOYEES

EQUITY LARGE FUNDS - TOTAL RATES OF RETURN

PERIODS ENDING 6/05

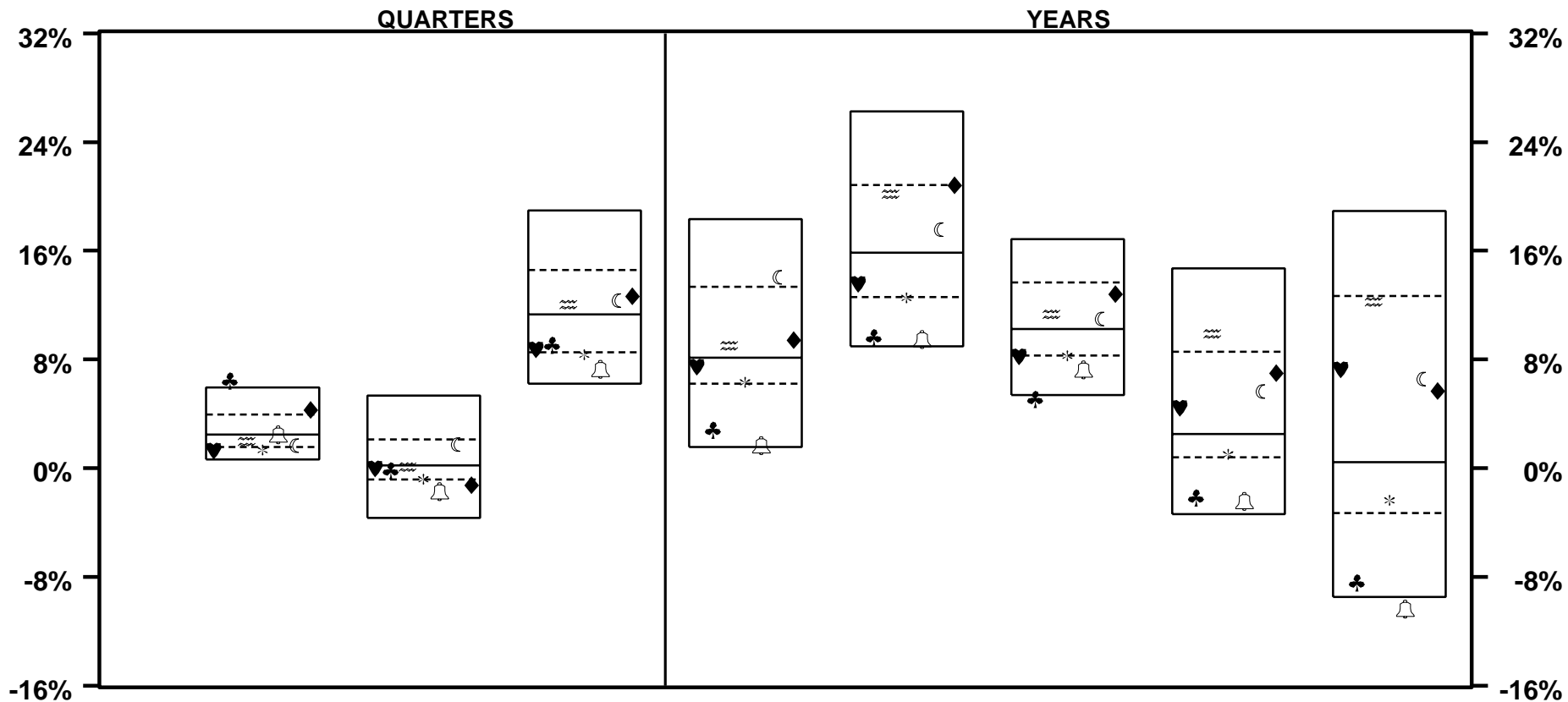

	LAST QTR		LAST 2 QTRS		LAST 3 QTRS		LAST YEAR		LAST 2 YEARS		LAST 3 YEARS		LAST 4 YEARS		LAST 5 YEARS	
♥ DELAWARE	1.3	88	0.0	55	8.7	73	7.5	56	13.6	63	8.2	75	4.5	42	7.3	40
♣ ALLIANCE	6.4	2	-0.2	58	9.1	70	2.8	87	9.7	93	5.1	95	-2.1	89	-8.4	91
≈ LAZARD	2.0	65	0.1	54	12.1	43	9.0	44	20.2	28	11.4	40	9.9	18	12.3	26
* S&P 500	1.4	82	-0.8	74	8.3	82	6.3	73	12.5	78	8.3	75	1.0	70	-2.4	68
🔔 R 1000(R) GR	2.5	50	-1.7	82	7.3	89	1.7	94	9.5	93	7.3	85	-2.4	90	-10.4	95
☾ R 1000(R) VALUE	1.7	72	1.8	31	12.3	42	14.1	19	17.5	39	11.0	43	5.6	36	6.6	43
◆ R 2000(R)	4.3	19	-1.3	78	12.7	39	9.4	43	20.8	25	12.8	31	7.0	29	5.7	44
MEDIAN	2.5		0.2		11.3		8.1		15.8		10.3		2.5		0.5	

VERMONT MUNICIPAL EMPLOYEES

EQUITY LARGE FUNDS - TOTAL RATES OF RETURN

PERIODS ENDING 6/05

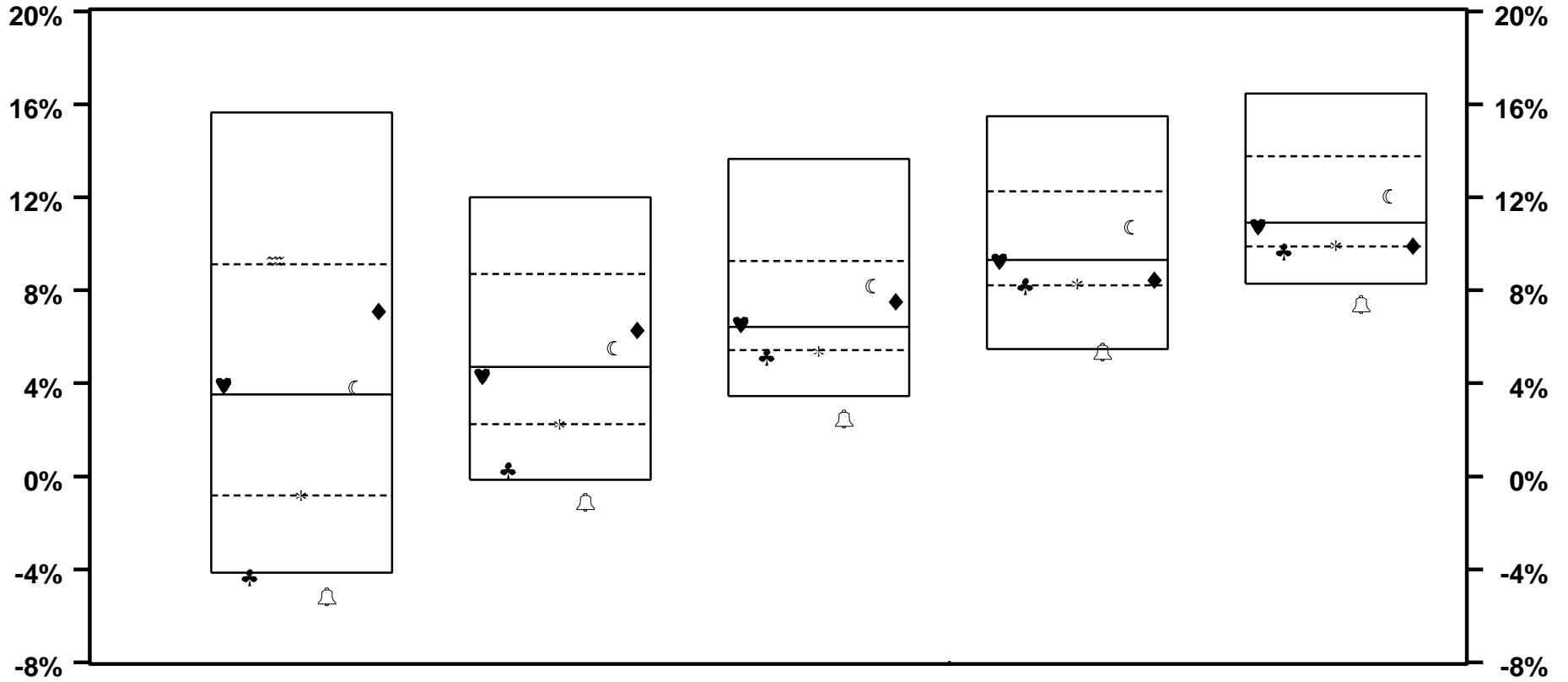

	LAST 6 YEARS		LAST 7 YEARS		LAST 8 YEARS		LAST 9 YEARS		LAST 10 YEARS	
♥ DELAWARE	3.9	46	4.3	51	6.5	48	9.3	51	10.7	53
♣ ALLIANCE	-4.3	95	0.3	91	5.1	84	8.2	75	9.7	77
≈ LAZARD	9.3	23								
* S&P 500	-0.8	74	2.2	74	5.4	78	8.3	71	9.9	70
🔔 R 1000(R) GR	-5.2	96	-1.1	98	2.5	99	5.3	95	7.4	99
☾ R 1000(R) VALUE	3.8	46	5.5	44	8.2	31	10.7	32	12.0	34
♦ R 2000(R)	7.1	33	6.3	37	7.5	41	8.5	59	9.9	74
MEDIAN	3.5		4.7		6.4		9.3		10.9	

VERMONT MUNICIPAL EMPLOYEES

EQUITY LARGE FUNDS - TOTAL RATES OF RETURN

YEARS ENDING

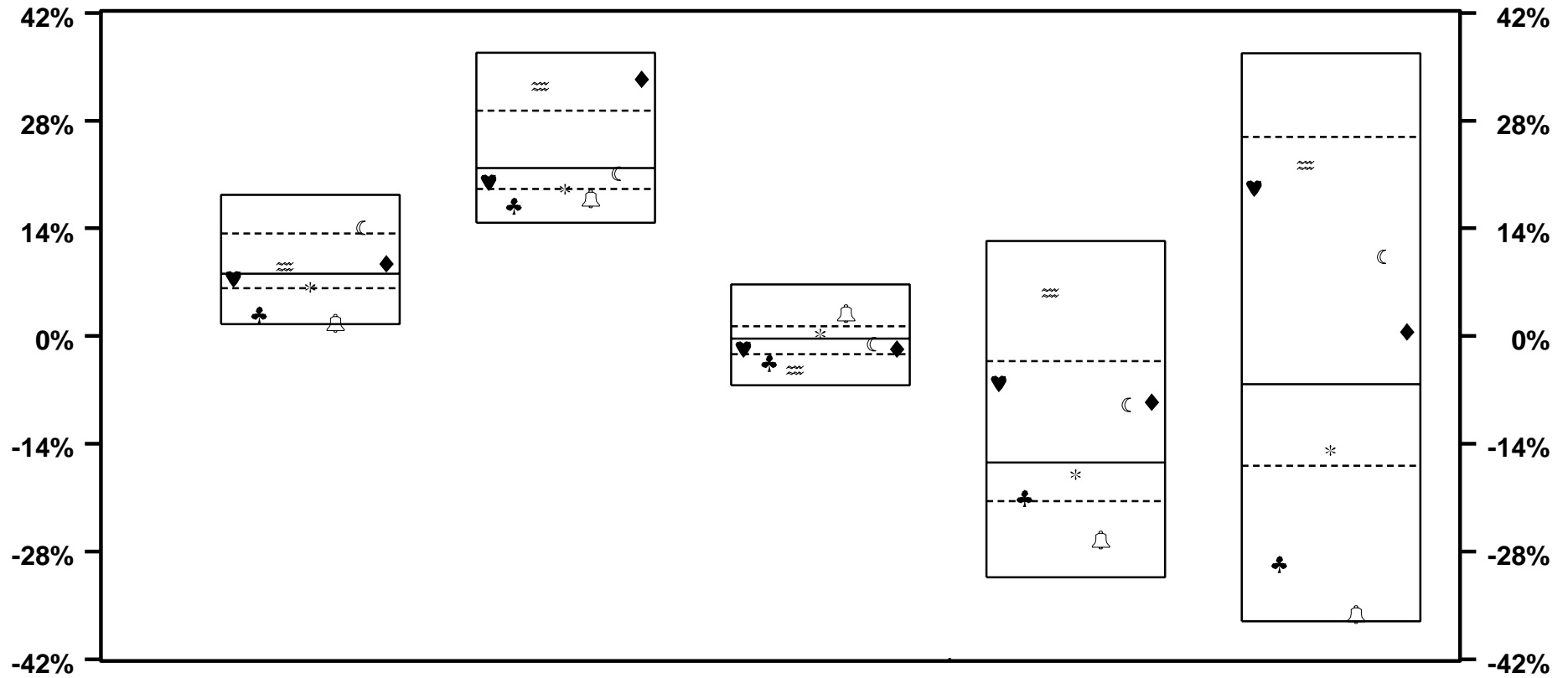

	6 / 05		6 / 04		6 / 03		6 / 02		6 / 01	
♥ DELAWARE	7.5	56	20.0	62	-1.7	67	-6.1	31	19.3	33
♣ ALLIANCE	2.8	87	16.9	89	-3.5	84	-21.0	73	-29.6	90
≈ LAZARD	9.0	44	32.5	14	-4.4	87	5.6	12	22.2	30
* S&P 500	6.3	73	19.1	74	0.3	43	-18.0	65	-14.8	67
🔔 R 1000(R) GR	1.7	94	17.9	84	2.9	14	-26.5	87	-36.2	94
☾ R 1000(R) VALUE	14.1	19	21.1	55	-1.0	59	-9.0	36	10.3	42
◆ R 2000(R)	9.4	43	33.4	12	-1.6	67	-8.6	35	0.6	48
MEDIAN	8.1		21.8		-0.3		-16.4		-6.2	

VERMONT MUNICIPAL EMPLOYEES

EQUITY LARGE FUNDS - TOTAL RATES OF RETURN

YEARS ENDING

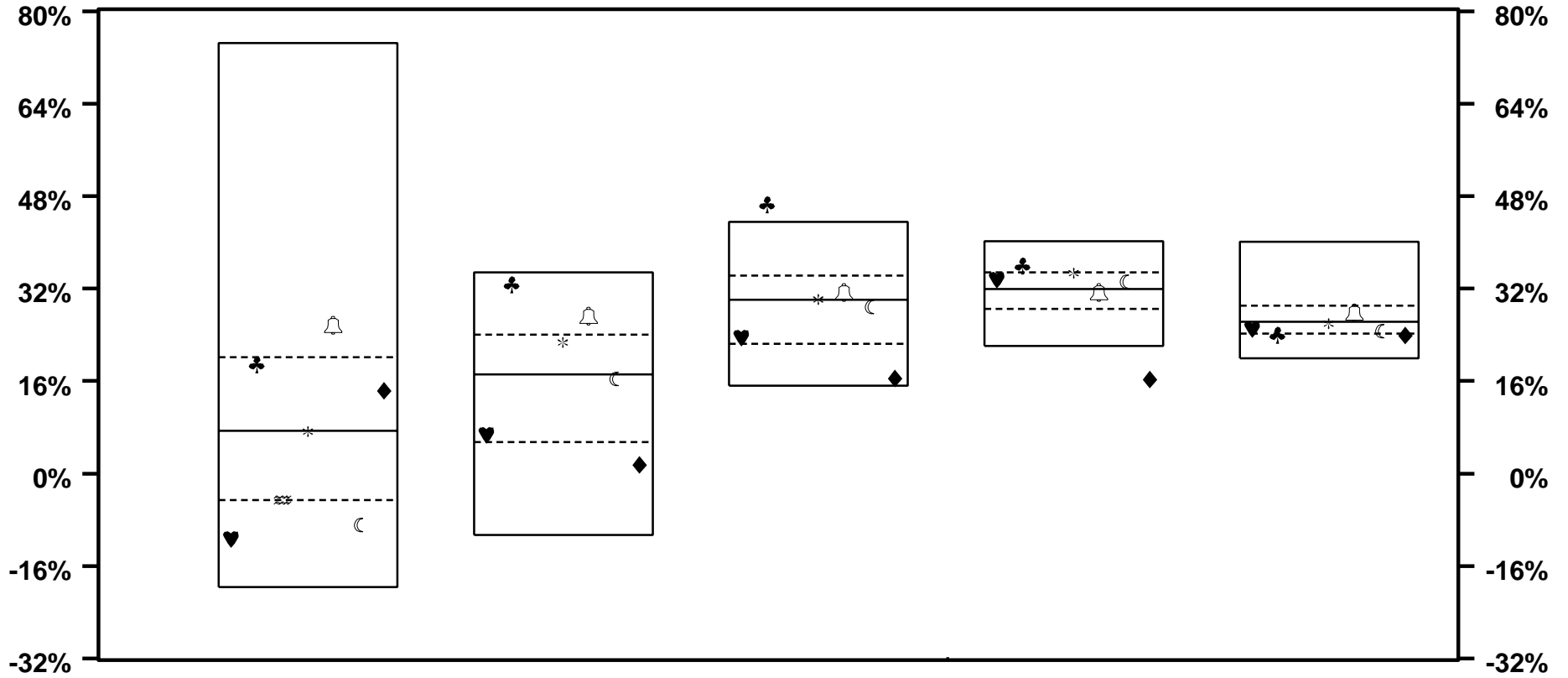

	6 / 00		6 / 99		6 / 98		6 / 97		6 / 96	
♥ DELAWARE	- 11.3	85	6.7	73	23.5	72	33.6	41	25.1	72
♣ ALLIANCE	18.9	26	32.8	7	46.6	1	36.0	18	24.0	76
≈ LAZARD	- 4.5	74								
* S&P 500	7.3	54	22.8	34	30.2	45	34.7	26	25.9	58
🔔 R 1000(R) GR	25.6	16	27.3	15	31.4	36	31.3	55	27.8	38
Ⓒ R 1000(R) VALUE	- 8.9	80	16.4	54	28.8	56	33.2	46	24.6	73
◆ R 2000(R)	14.3	33	1.5	78	16.5	90	16.3	98	23.9	76
MEDIAN	7.4		17.2		30.1		31.9		26.3	

VERMONT MUNICIPAL EMPLOYEES

EQUITY LARGE FUNDS - TOTAL RETURN VS RISK

3 YEARS ENDING 6/05

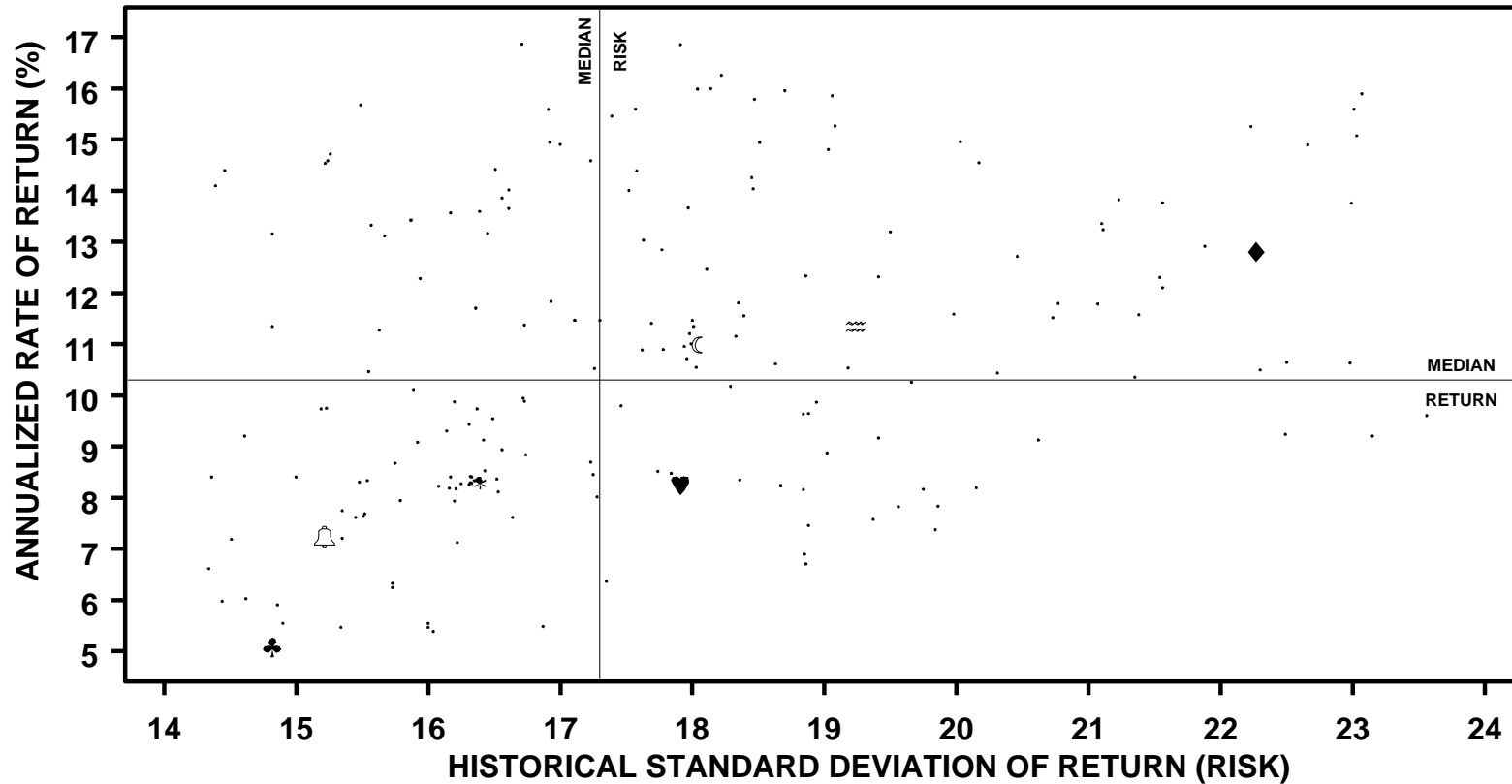

	ANNUALIZED RETURN		STANDARD DEVIATION		SHARPE RATIO	
	VALUE	RANK	VALUE	RANK	VALUE	RANK
♥ DELAWARE	8.2	75	17.9	43	0.5	76
♣ ALLIANCE	5.1	95	14.8	90	0.3	95
≍ LAZARD	11.4	40	19.2	24	0.6	41
* S&P 500	8.3	75	16.4	63	0.5	65
🔔 R 1000(R) GR	7.3	85	15.2	89	0.4	80
☾ R 1000(R) VALUE	11.0	43	18.0	39	0.6	39
◆ R 2000(R)	12.8	31	22.3	9	0.6	39
MEDIAN	10.3		17.3		0.6	

VERMONT MUNICIPAL EMPLOYEES

EQUITY LARGE FUNDS - TOTAL RETURN VS RISK

5 YEARS ENDING 6/05

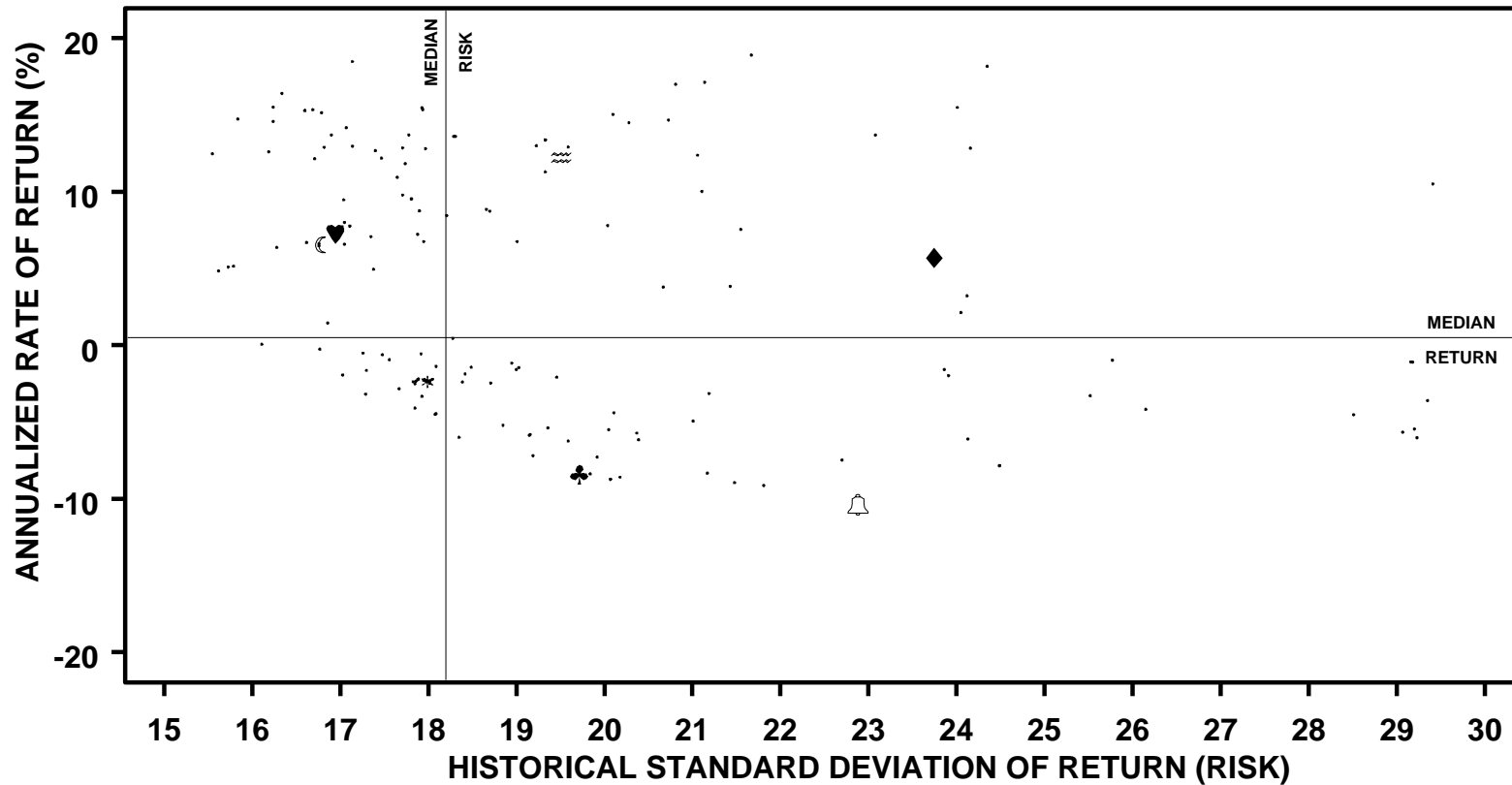

	ANNUALIZED RETURN		STANDARD DEVIATION		SHARPE RATIO	
	VALUE	RANK	VALUE	RANK	VALUE	RANK
♥ DELAWARE	7.3	40	17.0	80	0.4	38
♣ ALLIANCE	-8.4	91	19.7	35	-0.5	
≈ LAZARD	12.3	26	19.5	36	0.6	27
* S&P 500	-2.4	68	18.0	54	-0.2	
🔔 R 1000(R) GR	-10.4	95	22.9	18	-0.5	
☾ R 1000(R) VALUE	6.6	43	16.8	84	0.3	42
♦ R 2000(R)	5.7	44	23.7	17	0.2	44
MEDIAN	0.5		18.2		0.0	

VERMONT MUNICIPAL EMPLOYEES

EQUITY PUBLIC FUNDS - TOTAL RATES OF RETURN

PERIODS ENDING 6/05

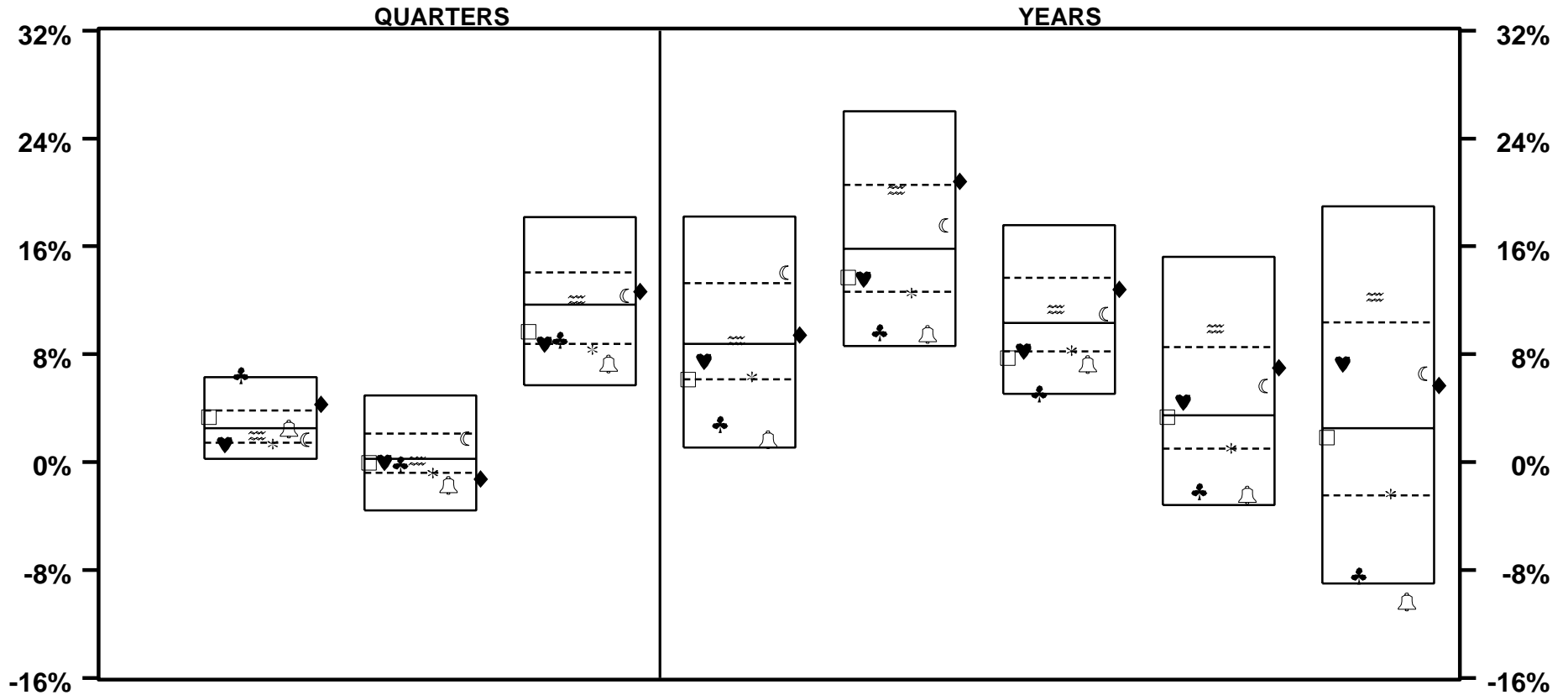

	LAST QTR		LAST 2 QTRS		LAST 3 QTRS		LAST YEAR		LAST 2 YEARS		LAST 3 YEARS		LAST 4 YEARS		LAST 5 YEARS	
□ EQTY COMPOSITE	3.3	32	0.0	58	9.7	67	6.1	74	13.7	66	7.7	79	3.4	51	1.8	52
♥ DELAWARE	1.3	83	0.0	57	8.7	75	7.5	57	13.6	69	8.2	73	4.5	44	7.3	37
♣ ALLIANCE	6.4	4	-0.2	60	9.1	73	2.8	89	9.7	92	5.1	94	-2.1	90	-8.4	93
≡ LAZARD	2.0	65	0.1	54	12.1	44	9.0	48	20.2	27	11.4	41	9.9	20	12.3	20
* S&P 500	1.4	79	-0.8	75	8.3	82	6.3	71	12.5	79	8.3	72	1.0	74	-2.4	73
🔔 R 1000(R) GR	2.5	51	-1.7	83	7.3	88	1.7	93	9.5	93	7.3	83	-2.4	91	-10.4	96
☾ R 1000(R) VALUE	1.7	71	1.8	30	12.3	42	14.1	19	17.5	38	11.0	44	5.6	37	6.6	40
◆ R 2000(R)	4.3	18	-1.3	79	12.7	38	9.4	47	20.8	23	12.8	30	7.0	29	5.7	43
MEDIAN	2.5		0.3		11.7		8.8		15.8		10.3		3.5		2.5	

VERMONT MUNICIPAL EMPLOYEES

EQUITY PUBLIC FUNDS - TOTAL RATES OF RETURN

PERIODS ENDING 6/05

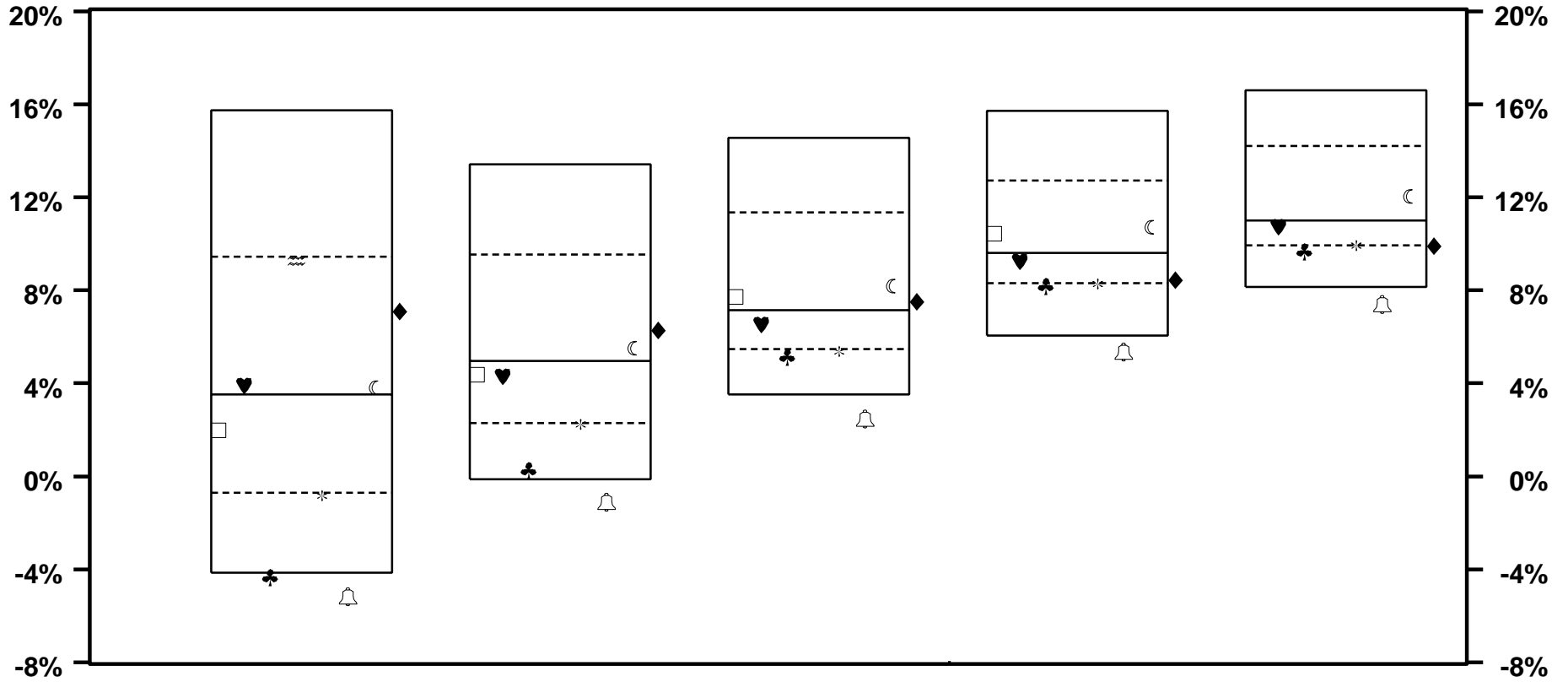

	LAST 6 YEARS		LAST 7 YEARS		LAST 8 YEARS		LAST 9 YEARS		LAST 10 YEARS	
□ EQTY COMPOSITE	2.0	60	4.4	56	7.7	44	10.4	37		
♥ DELAWARE	3.9	45	4.3	57	6.5	58	9.3	57	10.7	54
♣ ALLIANCE	-4.3	95	0.3	93	5.1	84	8.2	78	9.7	83
≍ LAZARD	9.3	25								
* S&P 500	-0.8	80	2.2	79	5.4	80	8.3	77	9.9	75
🔔 R 1000(R) GR	-5.2	97	-1.1	98	2.5	98	5.3	96	7.4	97
☾ R 1000(R) VALUE	3.8	46	5.5	46	8.2	40	10.7	37	12.0	39
◆ R 2000(R)	7.1	31	6.3	41	7.5	45	8.5	65	9.9	77
MEDIAN	3.5		5.0		7.1		9.6		11.0	

VERMONT MUNICIPAL EMPLOYEES

EQUITY PUBLIC FUNDS - TOTAL RATES OF RETURN

YEARS ENDING

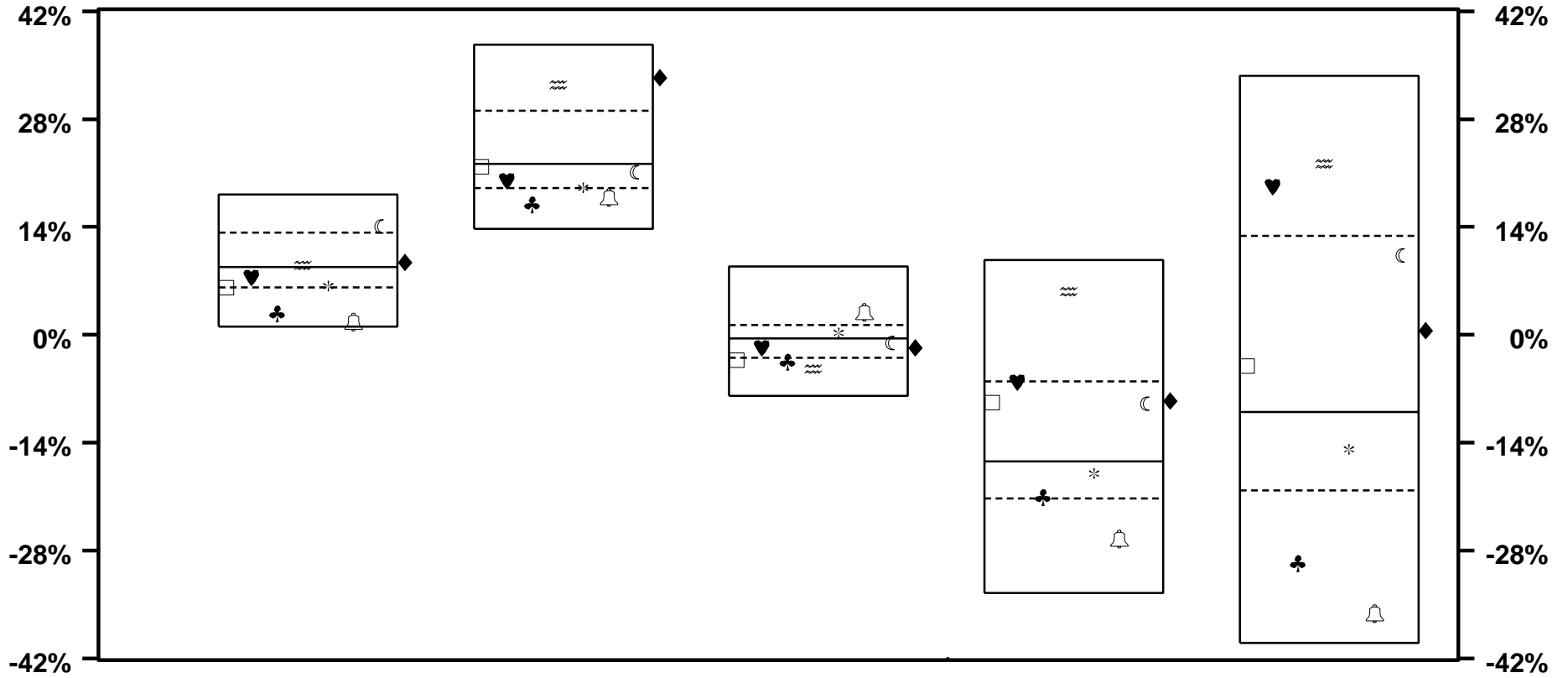

	6 / 05		6 / 04		6 / 03		6 / 02		6 / 01	
□ EQTY COMPOSITE	6.1	74	21.8	51	-3.3	77	-8.7	30	-4.1	45
♥ DELAWARE	7.5	57	20.0	63	-1.7	62	-6.1	25	19.3	18
♣ ALLIANCE	2.8	89	16.9	86	-3.5	78	-21.0	74	-29.6	86
≡ LAZARD	9.0	48	32.5	14	-4.4	84	5.6	9	22.2	16
* S&P 500	6.3	71	19.1	72	0.3	42	-18.0	62	-14.8	64
🔔 R 1000(R) GR	1.7	93	17.9	81	2.9	16	-26.5	85	-36.2	93
☾ R 1000(R) VALUE	14.1	19	21.1	56	-1.0	56	-9.0	31	10.3	30
◆ R 2000(R)	9.4	47	33.4	13	-1.6	62	-8.6	30	0.6	42
MEDIAN	8.8		22.2		-0.5		-16.4		-10.0	

VERMONT MUNICIPAL EMPLOYEES

EQUITY PUBLIC FUNDS - TOTAL RATES OF RETURN

YEARS ENDING

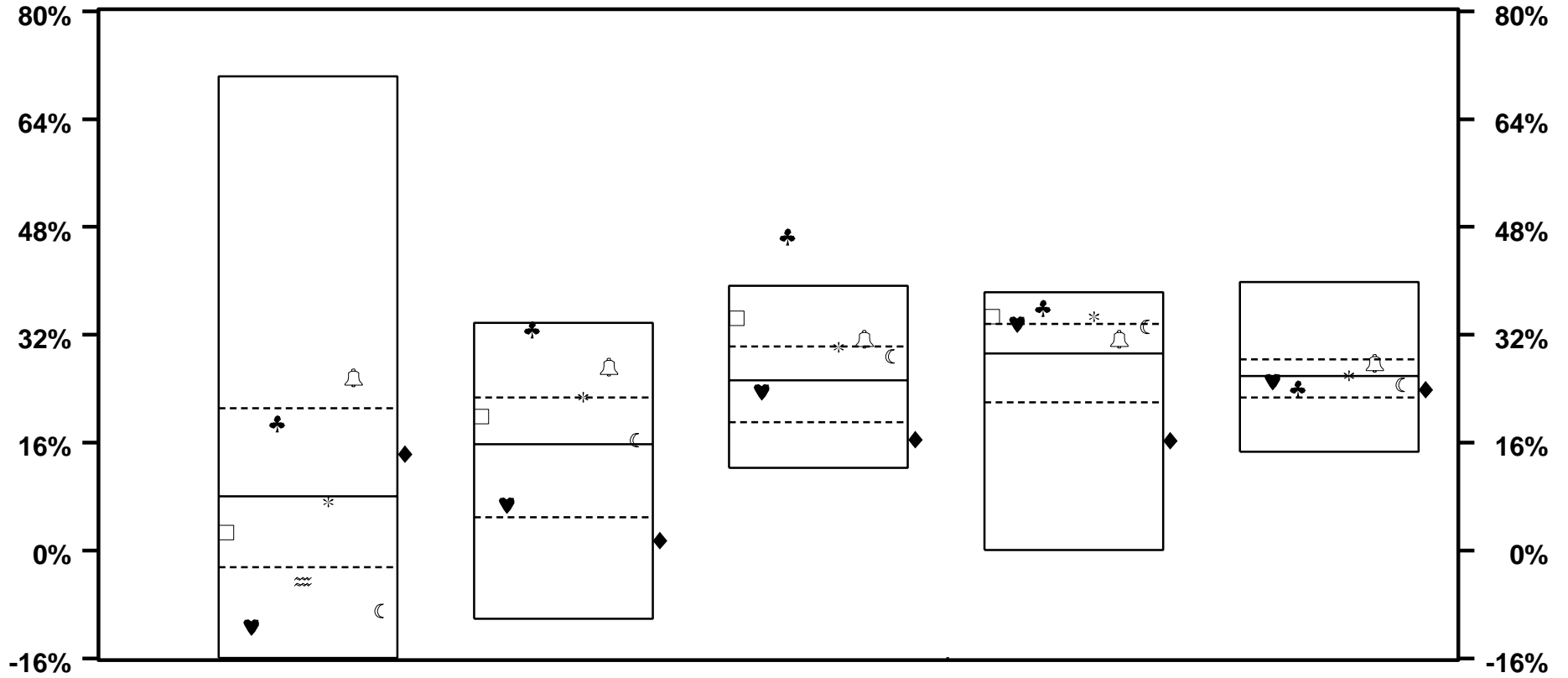

	6 / 00		6 / 99		6 / 98		6 / 97		6 / 96	
□ EQTY COMPOSITE	2.7	67	19.9	35	34.5	9	34.7	17		
♥ DELAWARE	-11.3	90	6.7	72	23.5	57	33.6	24	25.1	58
♣ ALLIANCE	18.9	29	32.8	6	46.6	1	36.0	9	24.0	65
≡ LAZARD	-4.5	78								
* S&P 500	7.3	57	22.8	24	30.2	27	34.7	16	25.9	48
🔔 R 1000(R) GR	25.6	20	27.3	12	31.4	18	31.3	38	27.8	26
☾ R 1000(R) VALUE	-8.9	85	16.4	47	28.8	36	33.2	27	24.6	61
◆ R 2000(R)	14.3	37	1.5	79	16.5	84	16.3	84	23.9	66
MEDIAN	8.0		15.7		25.3		29.2		25.9	

VERMONT MUNICIPAL EMPLOYEES

EQUITY PUBLIC FUNDS - TOTAL RETURN VS RISK

3 YEARS ENDING 6/05

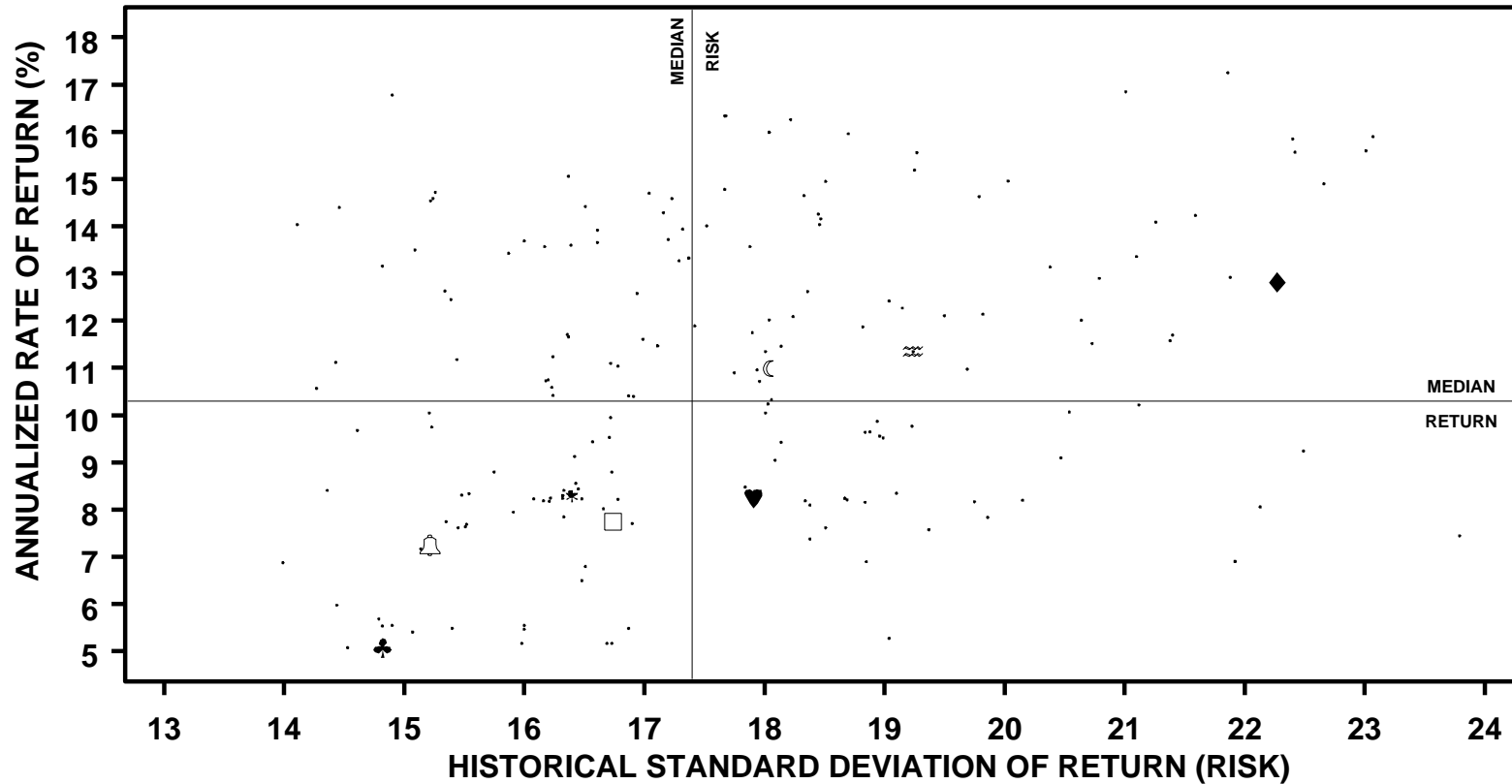

	ANNUALIZED RETURN		STANDARD DEVIATION		SHARPE RATIO	
	VALUE	RANK	VALUE	RANK	VALUE	RANK
□ EQTY COMPOSITE	7.7	79	16.7	59	0.4	77
♥ DELAWARE	8.2	73	17.9	45	0.5	76
♣ ALLIANCE	5.1	94	14.8	88	0.3	93
≈ LAZARD	11.4	41	19.2	29	0.6	46
* S&P 500	8.3	72	16.4	66	0.5	65
🔔 R 1000(R) GR	7.3	83	15.2	86	0.4	78
☾ R 1000(R) VALUE	11.0	44	18.0	44	0.6	44
◆ R 2000(R)	12.8	30	22.3	10	0.6	44
MEDIAN	10.3		17.4		0.6	

VERMONT MUNICIPAL EMPLOYEES

EQUITY PUBLIC FUNDS - TOTAL RETURN VS RISK

5 YEARS ENDING 6/05

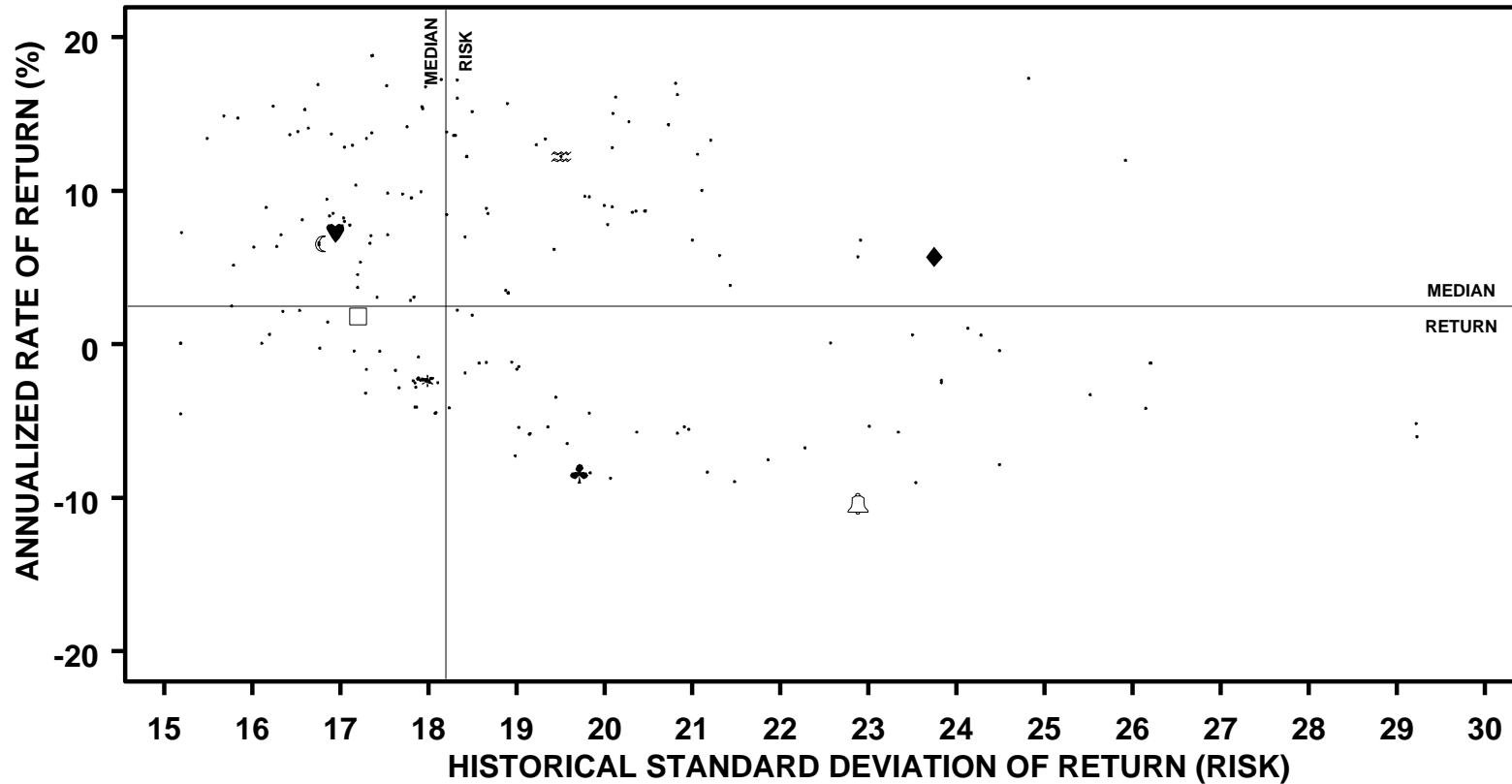

	ANNUALIZED RETURN		STANDARD DEVIATION		SHARPE RATIO	
	VALUE	RANK	VALUE	RANK	VALUE	RANK
□ EQTY COMPOSITE	1.8	52	17.2	74	0.0	53
♥ DELAWARE	7.3	37	17.0	77	0.4	35
♣ ALLIANCE	-8.4	93	19.7	35	-0.5	
⌘ LAZARD	12.3	20	19.5	37	0.6	21
* S&P 500	-2.4	73	18.0	54	-0.2	
🔔 R 1000(R) GR	-10.4	96	22.9	17	-0.5	
☾ R 1000(R) VALUE	6.6	40	16.8	80	0.3	39
◆ R 2000(R)	5.7	43	23.7	15	0.2	43
MEDIAN	2.5		18.2		0.1	

VERMONT MUNICIPAL EMPLOYEES

EQUITY ONLY LARGE FUNDS - RATES OF RETURN

PERIODS ENDING 6/05

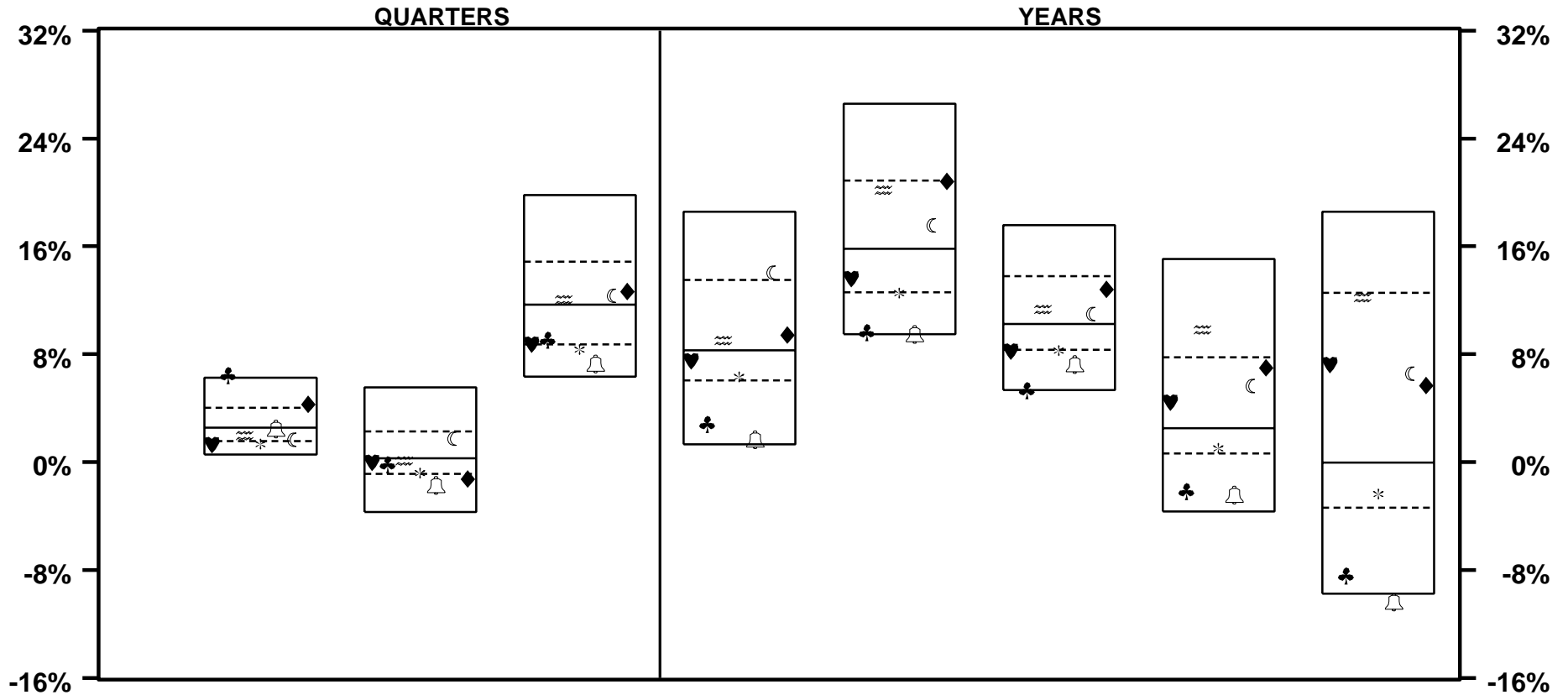

	LAST QTR		LAST 2 QTRS		LAST 3 QTRS		LAST YEAR		LAST 2 YEARS		LAST 3 YEARS		LAST 4 YEARS		LAST 5 YEARS	
♥ DELAWARE	1.3	87	0.0	56	8.8	73	7.5	56	13.6	65	8.2	77	4.5	41	7.3	38
♣ ALLIANCE	6.4	4	-0.2	59	9.1	72	2.8	88	9.7	94	5.3	95	-2.2	88	-8.4	91
≈ LAZARD	2.0	67	0.1	55	12.1	46	9.0	46	20.2	28	11.4	40	9.8	17	12.2	26
* S&P 500	1.4	83	-0.8	74	8.3	83	6.3	73	12.5	78	8.3	76	1.0	69	-2.4	68
🔔 R 1000(R) GR	2.5	52	-1.7	83	7.3	90	1.7	93	9.5	95	7.3	85	-2.4	88	-10.4	95
☾ R 1000(R) VALUE	1.7	73	1.8	32	12.3	43	14.1	20	17.5	40	11.0	42	5.6	34	6.6	40
◆ R 2000(R)	4.3	22	-1.3	78	12.7	41	9.4	45	20.8	25	12.8	31	7.0	29	5.7	42
MEDIAN	2.6		0.3		11.7		8.3		15.8		10.3		2.5		0.0	

VERMONT MUNICIPAL EMPLOYEES

EQUITY ONLY LARGE FUNDS - RATES OF RETURN

PERIODS ENDING 6/05

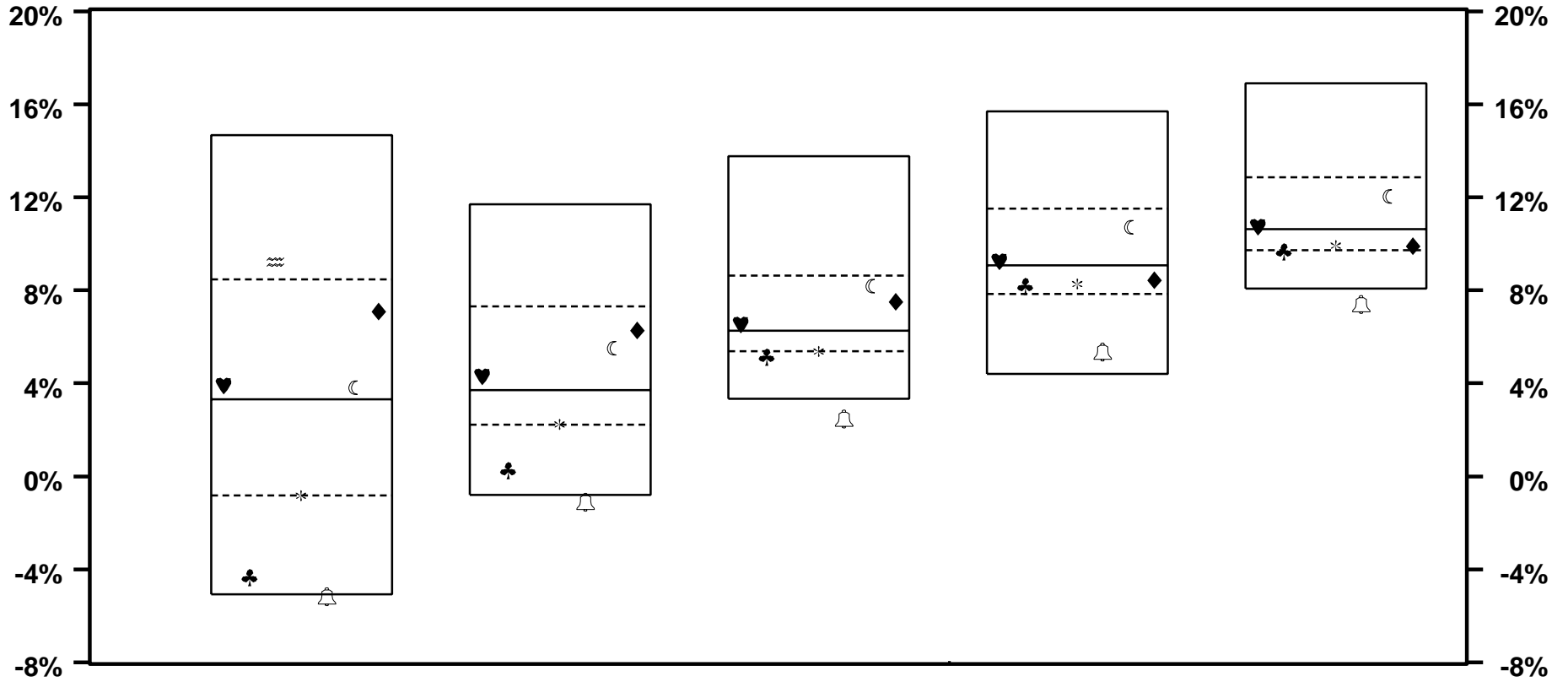

	LAST 6 YEARS		LAST 7 YEARS		LAST 8 YEARS		LAST 9 YEARS		LAST 10 YEARS	
♥ DELAWARE	3.9	41	4.3	47	6.5	47	9.3	45	10.7	47
♣ ALLIANCE	-4.3	91	0.3	89	5.1	81	8.2	73	9.7	75
≈ LAZARD	9.2	20								
* S&P 500	-0.8	75	2.2	73	5.4	76	8.3	67	9.9	67
🔔 R 1000(R) GR	-5.2	95	-1.1	96	2.5	98	5.3	92	7.4	96
☾ R 1000(R) VALUE	3.8	43	5.5	39	8.2	31	10.7	31	12.0	32
◆ R 2000(R)	7.1	26	6.3	34	7.5	38	8.5	54	9.9	70
MEDIAN	3.3		3.7		6.3		9.1		10.6	

VERMONT MUNICIPAL EMPLOYEES

EQUITY ONLY LARGE FUNDS - RATES OF RETURN

YEARS ENDING

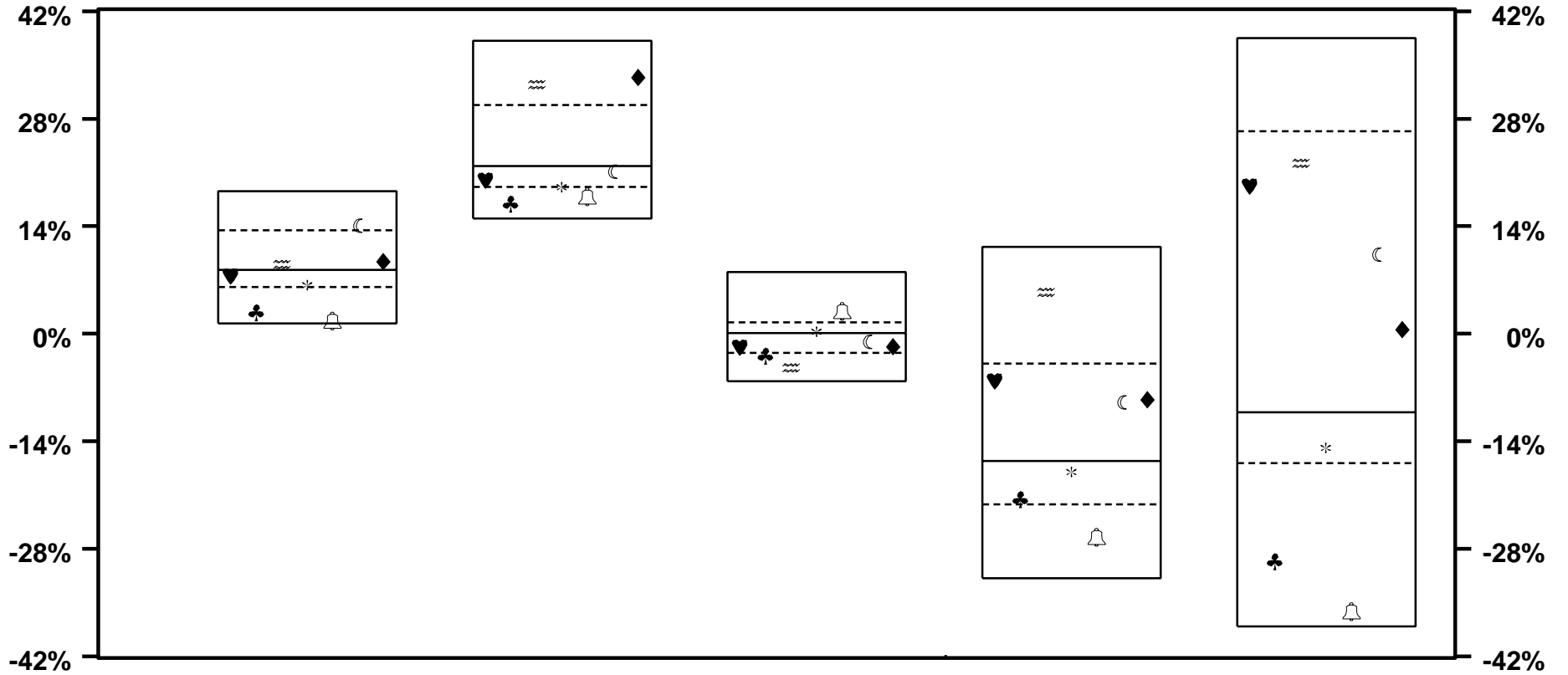

	6 / 05		6 / 04		6 / 03		6 / 02		6 / 01	
♥ DELAWARE	7.5	56	20.0	66	-1.7	68	-6.1	28	19.3	32
♣ ALLIANCE	2.8	88	16.9	91	-2.8	78	-21.5	73	-29.6	90
≈ LAZARD	9.0	46	32.5	14	-4.4	87	5.4	13	22.2	29
* S&P 500	6.3	73	19.1	75	0.3	46	-18.0	62	-14.8	67
🔔 R 1000(R) GR	1.7	93	17.9	86	2.9	16	-26.5	86	-36.2	94
☾ R 1000(R) VALUE	14.1	20	21.1	55	-1.0	61	-9.0	34	10.3	41
◆ R 2000(R)	9.4	45	33.4	13	-1.6	68	-8.6	33	0.6	47
MEDIAN	8.3		21.8		0.1		-16.6		-10.2	

VERMONT MUNICIPAL EMPLOYEES

EQUITY ONLY LARGE FUNDS - RATES OF RETURN

YEARS ENDING

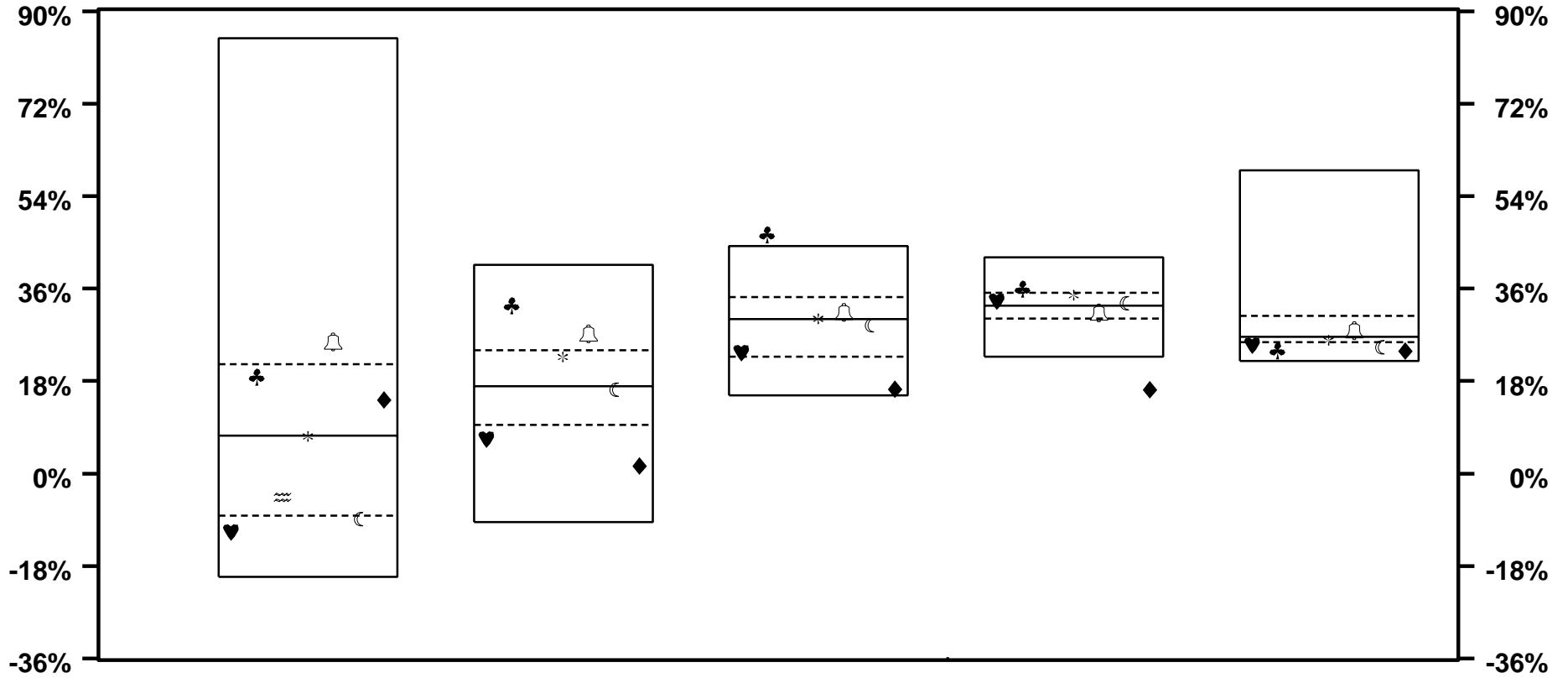

	6 / 00		6 / 99		6 / 98		6 / 97		6 / 96	
♥ DELAWARE	- 11.3	82	6.7	76	23.5	72	33.6	45	25.1	80
♣ ALLIANCE	18.9	28	32.8	10	46.6	2	36.0	22	24.0	86
≡ LAZARD	- 4.5	70								
* S&P 500	7.3	54	22.8	37	30.2	47	34.7	31	25.9	69
🔔 R 1000(R) GR	25.6	20	27.3	16	31.4	35	31.3	62	27.8	41
☾ R 1000(R) VALUE	- 8.9	75	16.4	53	28.8	57	33.2	48	24.6	82
◆ R 2000(R)	14.3	37	1.5	81	16.5	91	16.3	98	23.9	86
MEDIAN	7.4		17.0		30.1		32.7		26.6	

VERMONT MUNICIPAL EMPLOYEES

EQUITY ONLY LARGE FUNDS - RETURN VS RISK

3 YEARS ENDING 6/05

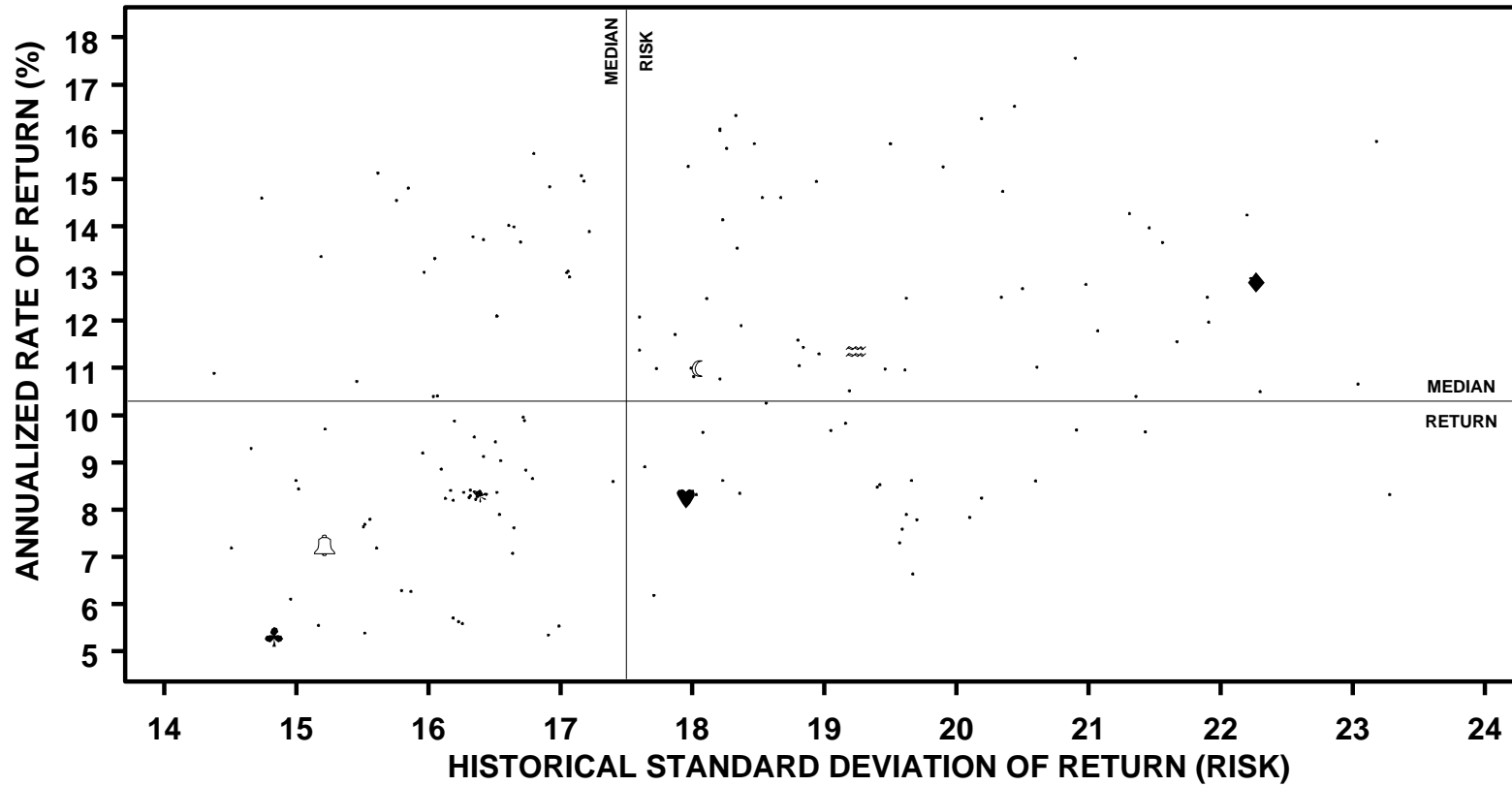

	ANNUALIZED RETURN		STANDARD DEVIATION		SHARPE RATIO	
	VALUE	RANK	VALUE	RANK	VALUE	RANK
♥ DELAWARE	8.2	77	18.0	46	0.5	75
♣ ALLIANCE	5.3	95	14.8	93	0.3	92
≍ LAZARD	11.4	40	19.2	30	0.6	40
* S&P 500	8.3	76	16.4	67	0.5	65
🔔 R 1000(R) GR	7.3	85	15.2	90	0.4	79
☾ R 1000(R) VALUE	11.0	42	18.0	44	0.6	39
♦ R 2000(R)	12.8	31	22.3	8	0.6	39
MEDIAN	10.3		17.5		0.6	

VERMONT MUNICIPAL EMPLOYEES

EQUITY ONLY LARGE FUNDS - RETURN VS RISK

5 YEARS ENDING 6/05

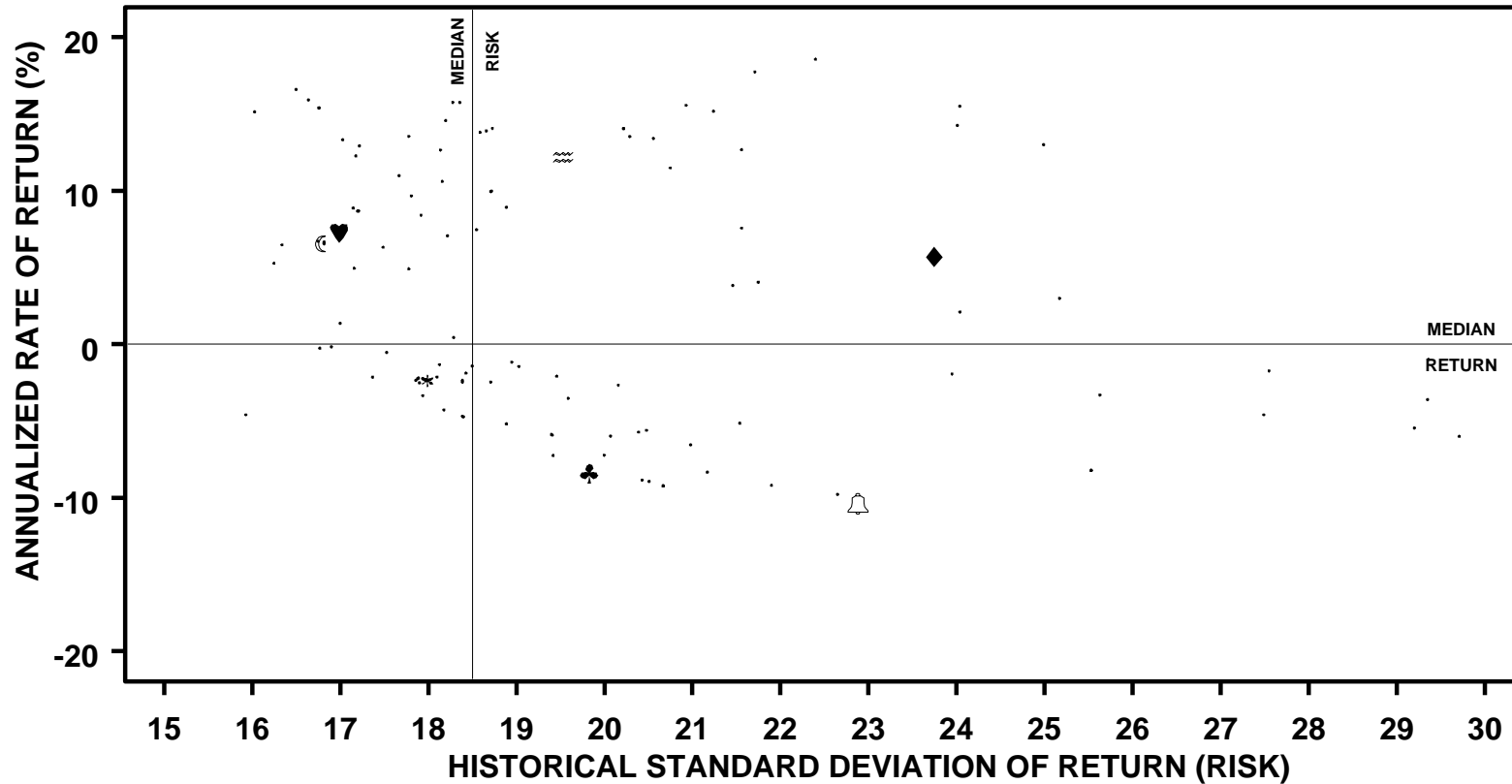

	ANNUALIZED RETURN		STANDARD DEVIATION		SHARPE RATIO	
	VALUE	RANK	VALUE	RANK	VALUE	RANK
♥ DELAWARE	7.3	38	17.0	84	0.3	36
♣ ALLIANCE	-8.4	91	19.8	38	-0.5	
≈ LAZARD	12.2	26	19.5	39	0.6	24
* S&P 500	-2.4	68	18.0	63	-0.2	
🔔 R 1000(R) GR	-10.4	95	22.9	18	-0.5	
☾ R 1000(R) VALUE	6.6	40	16.8	88	0.3	40
♦ R 2000(R)	5.7	42	23.7	17	0.2	42
MEDIAN	0.0		18.5		0.0	

VERMONT MUNICIPAL EMPLOYEES

EQUITY ONLY PUBLIC FUNDS - RATES OF RETURN

PERIODS ENDING 6/05

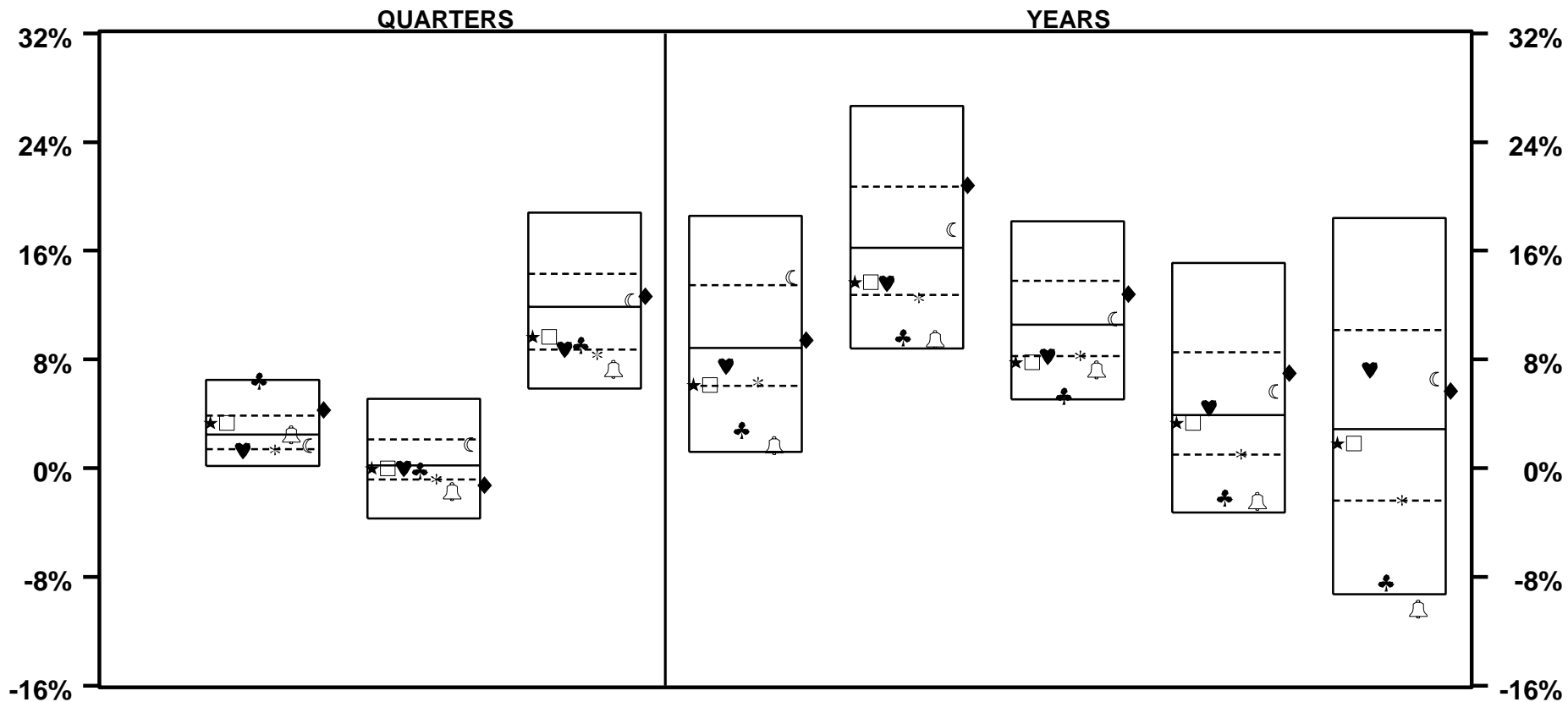

	LAST QTR		LAST 2 QTRS		LAST 3 QTRS		LAST YEAR		LAST 2 YEARS		LAST 3 YEARS		LAST 4 YEARS		LAST 5 YEARS	
★ MUNI COMPOSITE	3.3	32	0.0	56	9.7	67	6.2	74	13.7	68	7.8	80	3.3	52	1.8	52
□ EQTY COMPOSITE	3.3	32	0.0	56	9.7	67	6.2	74	13.7	68	7.8	80	3.3	52	1.8	52
♥ DELAWARE	1.3	82	0.0	55	8.8	74	7.5	56	13.6	69	8.2	75	4.5	45	7.3	36
♣ ALLIANCE	6.4	5	-0.2	59	9.1	72	2.8	89	9.7	93	5.3	93	-2.2	90	-8.4	93
* S&P 500	1.4	78	-0.8	73	8.3	81	6.3	71	12.5	80	8.3	74	1.0	74	-2.4	73
🔔 R 1000(R) GR	2.5	50	-1.7	83	7.3	88	1.7	93	9.5	94	7.3	85	-2.4	92	-10.4	95
☾ R 1000(R) VALUE	1.7	69	1.8	30	12.3	43	14.1	20	17.5	42	11.0	46	5.6	37	6.6	40
◆ R 2000(R)	4.3	18	-1.3	78	12.7	40	9.4	47	20.8	24	12.8	32	7.0	30	5.7	43
MEDIAN	2.5		0.2		11.9		8.8		16.2		10.6		3.9		2.9	

VERMONT MUNICIPAL EMPLOYEES

EQUITY ONLY PUBLIC FUNDS - RATES OF RETURN

PERIODS ENDING 6/05

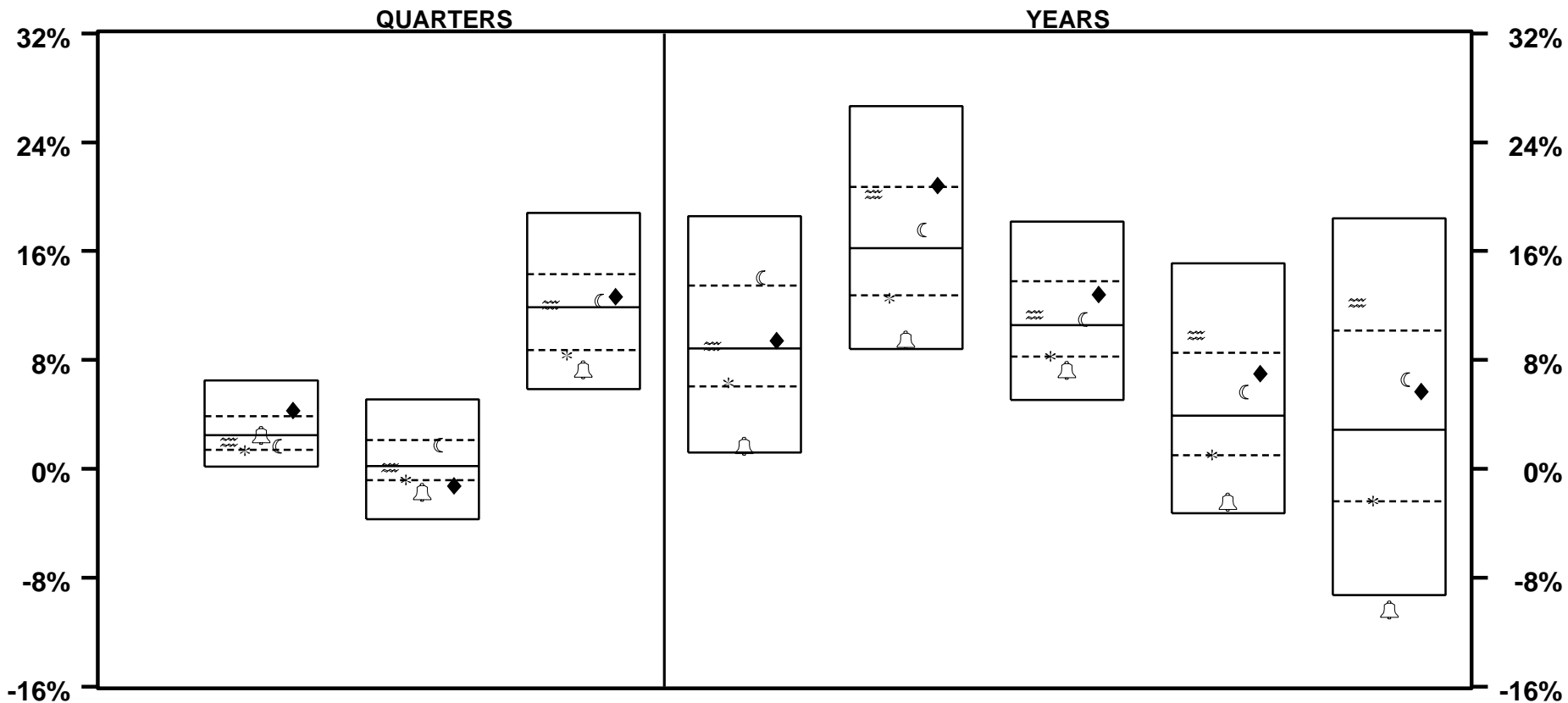

	LAST QTR		LAST 2 QTRS		LAST 3 QTRS		LAST YEAR		LAST 2 YEARS		LAST 3 YEARS		LAST 4 YEARS		LAST 5 YEARS	
≈ LAZARD	2.0	64	0.1	53	12.1	46	9.0	49	20.2	28	11.4	43	9.8	21	12.2	20
* S&P 500	1.4	78	-0.8	73	8.3	81	6.3	71	12.5	80	8.3	74	1.0	74	-2.4	73
🔔 R 1000(R) GR	2.5	50	-1.7	83	7.3	88	1.7	93	9.5	94	7.3	85	-2.4	92	-10.4	95
☾ R 1000(R) VALUE	1.7	69	1.8	30	12.3	43	14.1	20	17.5	42	11.0	46	5.6	37	6.6	40
◆ R 2000(R)	4.3	18	-1.3	78	12.7	40	9.4	47	20.8	24	12.8	32	7.0	30	5.7	43
MEDIAN	2.5		0.2		11.9		8.8		16.2		10.6		3.9		2.9	

VERMONT MUNICIPAL EMPLOYEES

EQUITY ONLY PUBLIC FUNDS - RATES OF RETURN

PERIODS ENDING 6/05

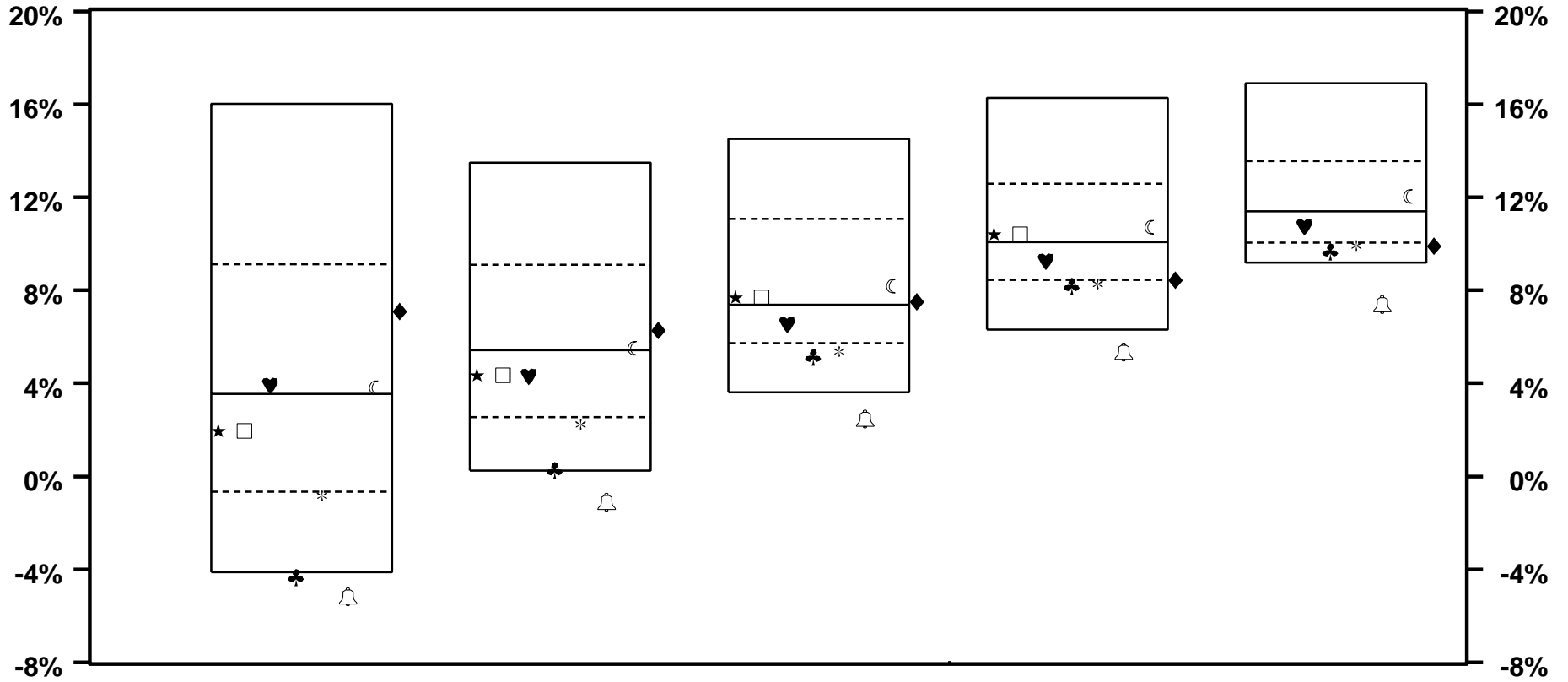

	LAST 6 YEARS		LAST 7 YEARS		LAST 8 YEARS		LAST 9 YEARS		LAST 10 YEARS	
★ MUNI COMPOSITE	2.0	62	4.4	57	7.7	47	10.4	46		
□ EQTY COMPOSITE	2.0	62	4.4	57	7.7	47	10.4	46		
♥ DELAWARE	3.9	45	4.3	57	6.5	64	9.3	63	10.7	58
♣ ALLIANCE	-4.3	95	0.3	94	5.1	85	8.2	83	9.7	86
* S&P 500	-0.8	80	2.2	83	5.4	82	8.3	79	9.9	78
🔔 R 1000(R) GR	-5.2	97	-1.1	99	2.5	100	5.3	98	7.4	98
☾ R 1000(R) VALUE	3.8	47	5.5	48	8.2	44	10.7	42	12.0	41
◆ R 2000(R)	7.1	28	6.3	44	7.5	48	8.5	73	9.9	80
MEDIAN	3.6		5.4		7.4		10.1		11.4	

VERMONT MUNICIPAL EMPLOYEES

EQUITY ONLY PUBLIC FUNDS - RATES OF RETURN

PERIODS ENDING 6/05

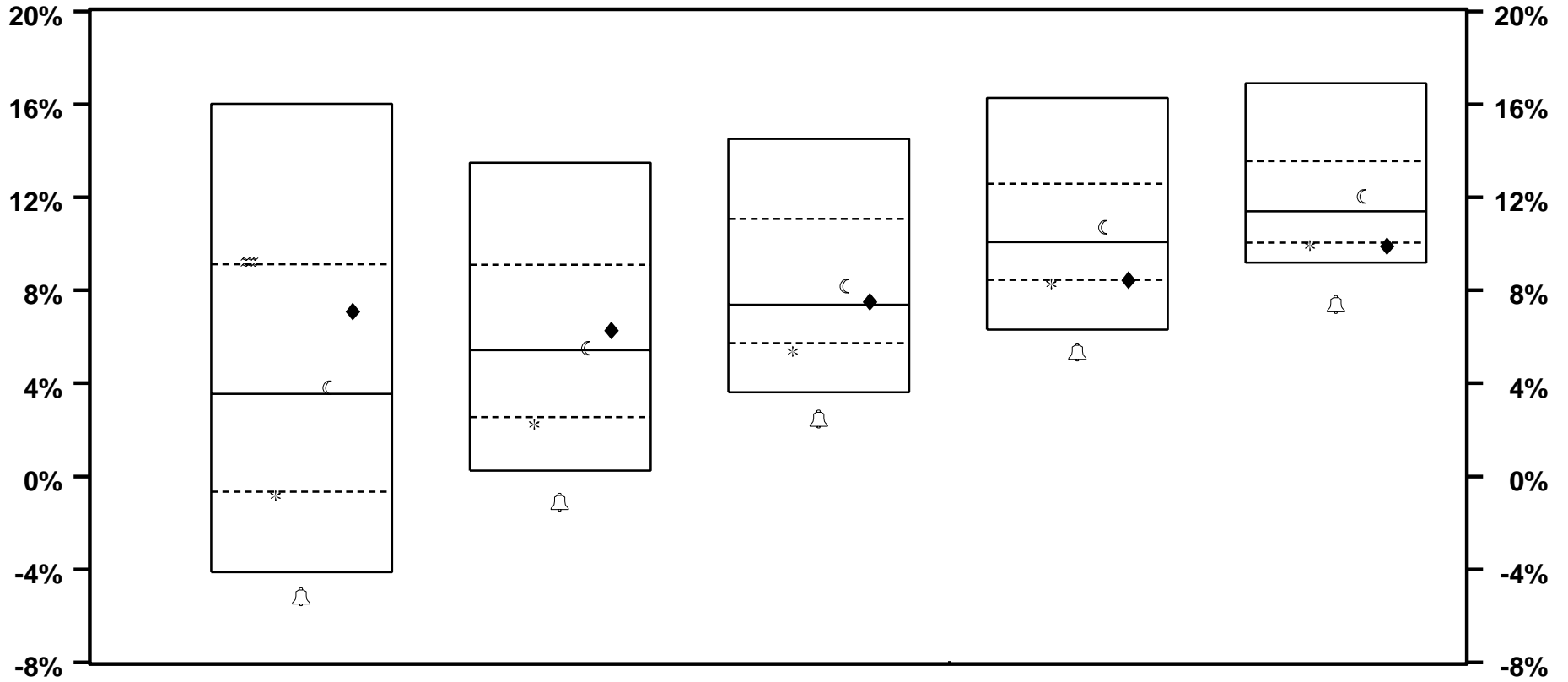

	LAST 6 YEARS		LAST 7 YEARS		LAST 8 YEARS		LAST 9 YEARS		LAST 10 YEARS	
≈ LAZARD	9.2	24								
* S&P 500	-0.8	80	2.2	83	5.4	82	8.3	79	9.9	78
🔔 R 1000(R) GR	-5.2	97	-1.1	99	2.5	100	5.3	98	7.4	98
⊂ R 1000(R) VALUE	3.8	47	5.5	48	8.2	44	10.7	42	12.0	41
◆ R 2000(R)	7.1	28	6.3	44	7.5	48	8.5	73	9.9	80
MEDIAN	3.6		5.4		7.4		10.1		11.4	

VERMONT MUNICIPAL EMPLOYEES

EQUITY ONLY PUBLIC FUNDS - RATES OF RETURN

YEARS ENDING

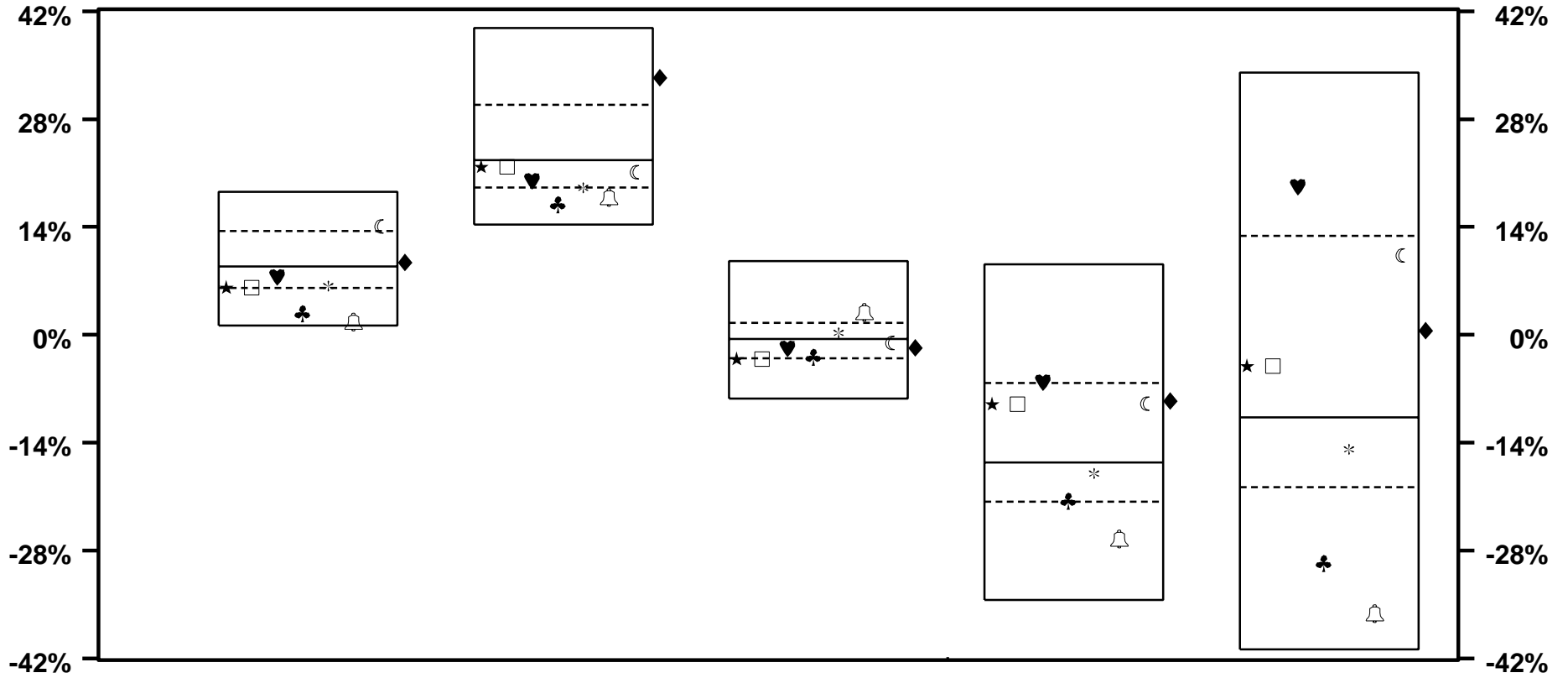

	6 / 05		6 / 04		6 / 03		6 / 02		6 / 01	
★ MUNI COMPOSITE	6.2	74	21.8	55	-3.2	76	-9.0	30	-4.1	44
□ EQTY COMPOSITE	6.2	74	21.8	55	-3.2	76	-9.0	30	-4.1	44
♥ DELAWARE	7.5	56	20.0	66	-1.7	63	-6.1	24	19.3	18
♣ ALLIANCE	2.8	89	16.9	87	-2.8	71	-21.5	74	-29.6	86
* S&P 500	6.3	71	19.1	74	0.3	42	-18.0	61	-14.8	64
🔔 R 1000(R) GR	1.7	93	17.9	83	2.9	17	-26.5	84	-36.2	93
☾ R 1000(R) VALUE	14.1	20	21.1	59	-1.0	56	-9.0	30	10.3	30
◆ R 2000(R)	9.4	47	33.4	15	-1.6	62	-8.6	29	0.6	41
MEDIAN	8.8		22.7		-0.5		-16.6		-10.7	

VERMONT MUNICIPAL EMPLOYEES

EQUITY ONLY PUBLIC FUNDS - RATES OF RETURN

YEARS ENDING

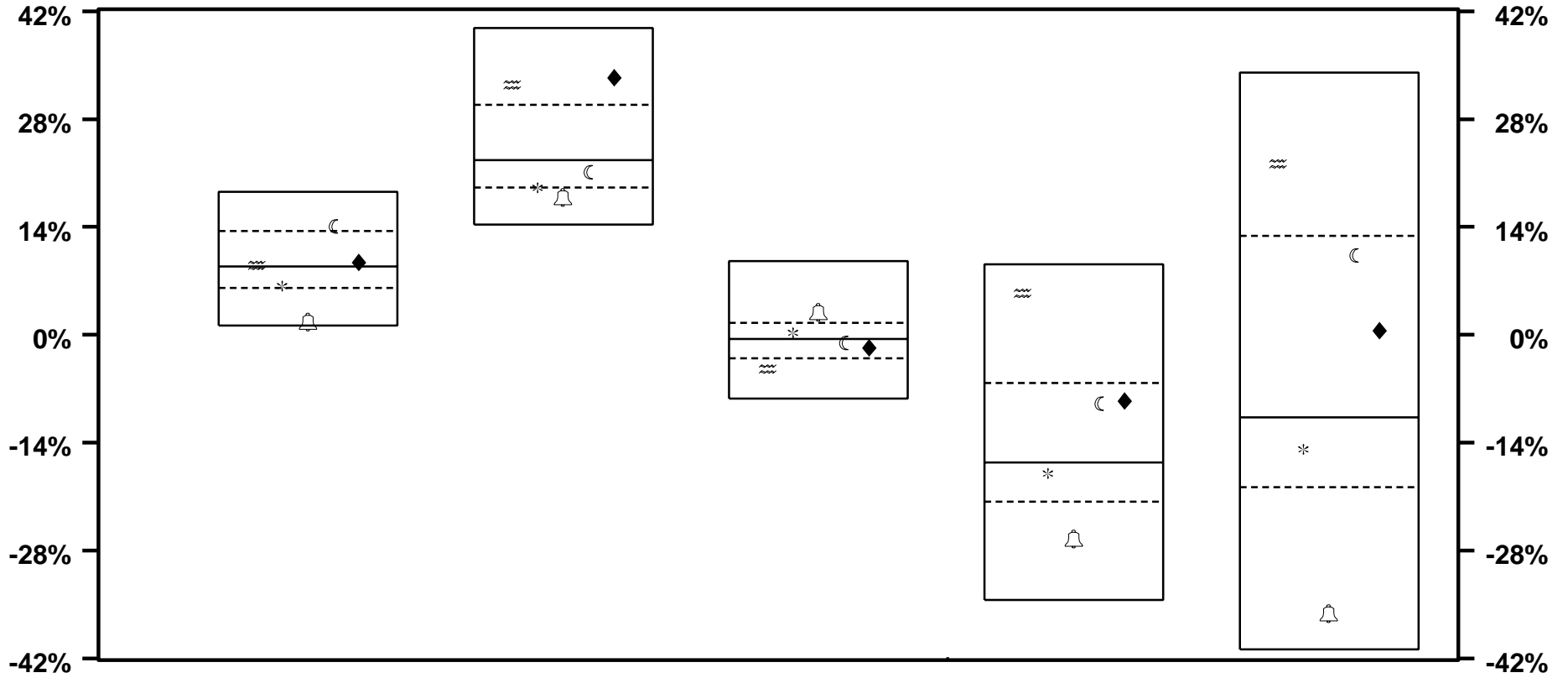

	6 / 05		6 / 04		6 / 03		6 / 02		6 / 01	
≈ LAZARD	9.0	49	32.5	16	-4.4	83	5.4	9	22.2	16
* S&P 500	6.3	71	19.1	74	0.3	42	-18.0	61	-14.8	64
🔔 R 1000(R) GR	1.7	93	17.9	83	2.9	17	-26.5	84	-36.2	93
Ⓒ R 1000(R) VALUE	14.1	20	21.1	59	-1.0	56	-9.0	30	10.3	30
◆ R 2000(R)	9.4	47	33.4	15	-1.6	62	-8.6	29	0.6	41
MEDIAN	8.8		22.7		-0.5		-16.6		-10.7	

VERMONT MUNICIPAL EMPLOYEES

EQUITY ONLY PUBLIC FUNDS - RATES OF RETURN

YEARS ENDING

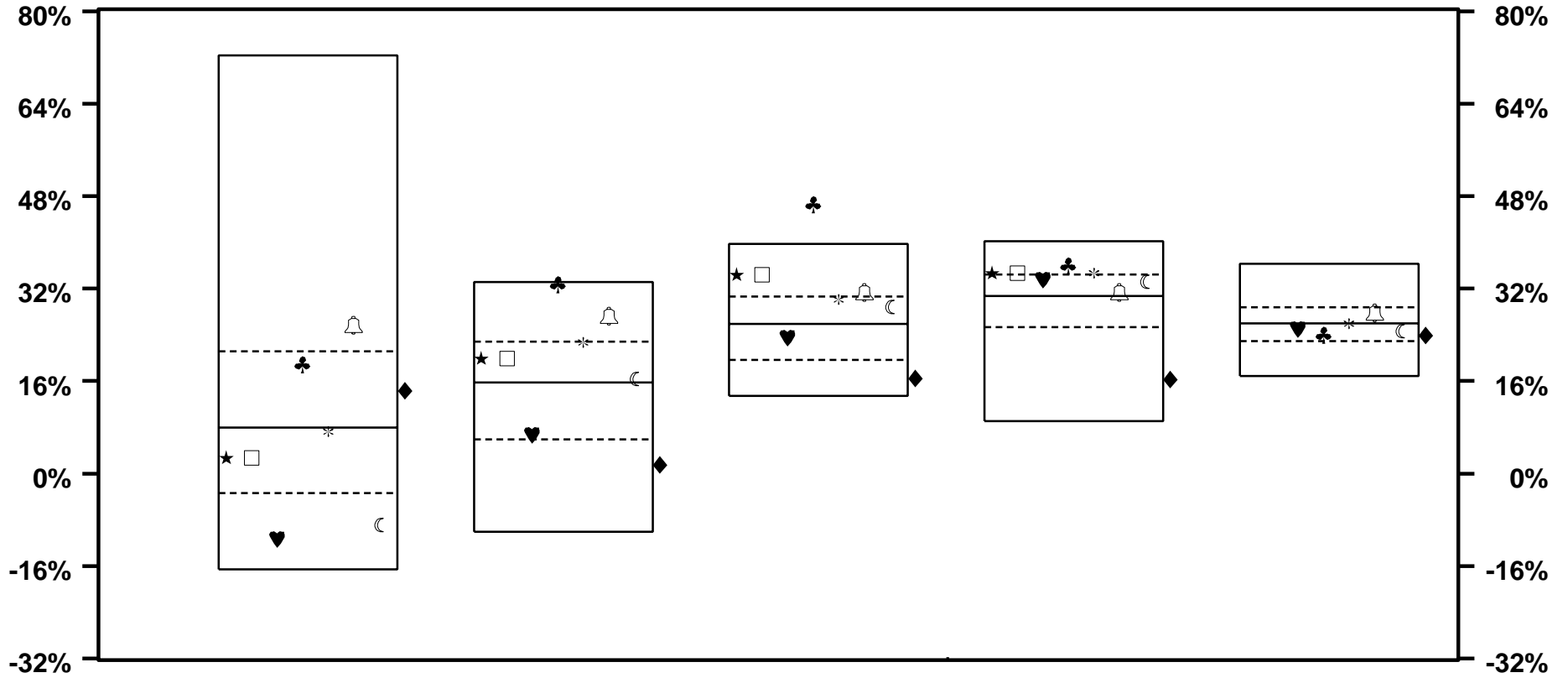

	6 / 00		6 / 99		6 / 98		6 / 97		6 / 96	
★ MUNI COMPOSITE	2.7	65	19.9	36	34.5	11	34.7	23		
□ EQTY COMPOSITE	2.7	65	19.9	36	34.5	11	34.7	23		
♥ DELAWARE	- 11.3	88	6.7	74	23.5	59	33.6	30	25.1	59
♣ ALLIANCE	18.9	28	32.8	5	46.6	1	36.0	14	24.0	67
* S&P 500	7.3	55	22.8	25	30.2	30	34.7	23	25.9	50
🔔 R 1000(R) GR	25.6	20	27.3	12	31.4	20	31.3	45	27.8	31
☾ R 1000(R) VALUE	- 8.9	83	16.4	48	28.8	36	33.2	33	24.6	62
◆ R 2000(R)	14.3	37	1.5	80	16.5	87	16.3	90	23.9	69
MEDIAN	8.0		15.7		25.9		30.7		25.9	

VERMONT MUNICIPAL EMPLOYEES

EQUITY ONLY PUBLIC FUNDS - RATES OF RETURN

YEARS ENDING

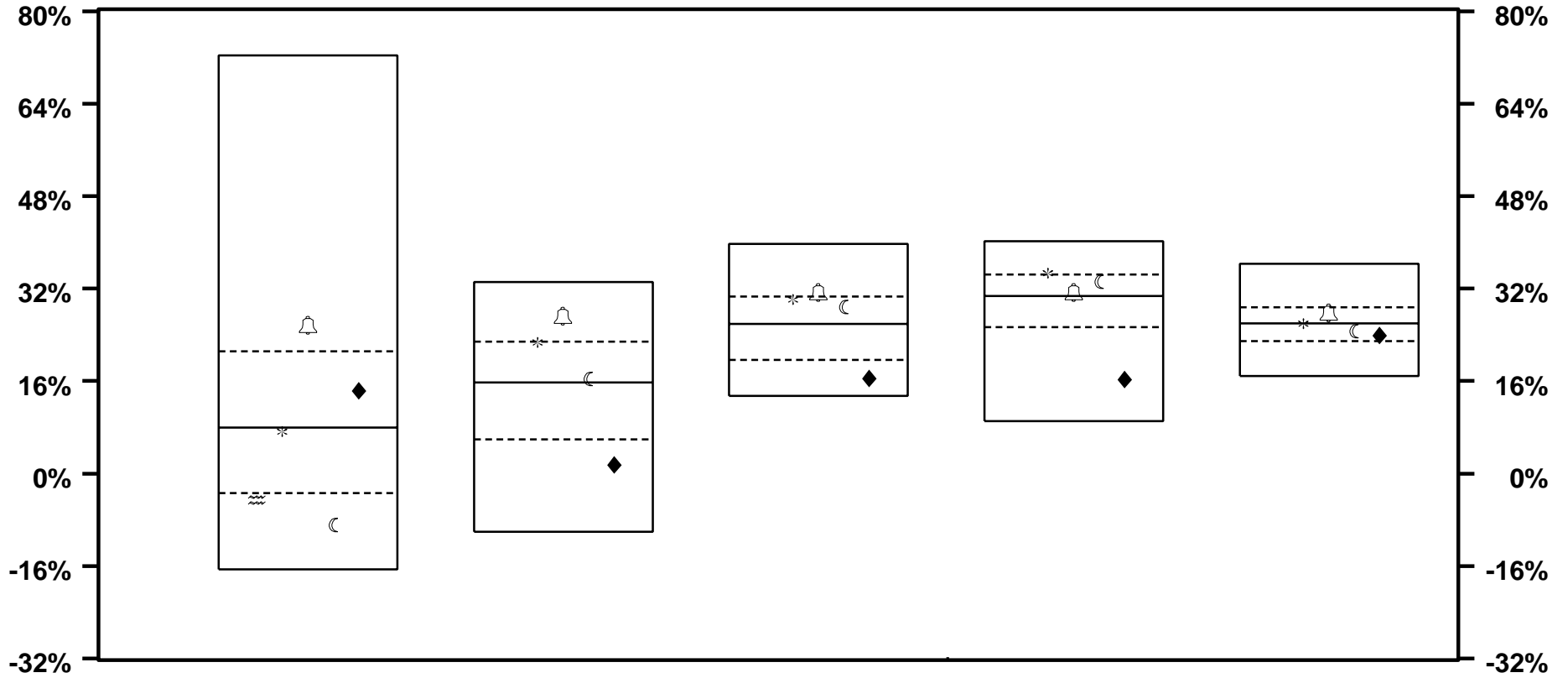

	6 / 00		6 / 99		6 / 98		6 / 97		6 / 96	
≈ LAZARD	- 4.5	76								
* S&P 500	7.3	55	22.8	25	30.2	30	34.7	23	25.9	50
🔔 R 1000(R) GR	25.6	20	27.3	12	31.4	20	31.3	45	27.8	31
Ⓒ R 1000(R) VALUE	- 8.9	83	16.4	48	28.8	36	33.2	33	24.6	62
◆ R 2000(R)	14.3	37	1.5	80	16.5	87	16.3	90	23.9	69
MEDIAN	8.0		15.7		25.9		30.7		25.9	

VERMONT MUNICIPAL EMPLOYEES

EQUITY ONLY PUBLIC FUNDS - RETURN VS RISK

3 YEARS ENDING 6/05

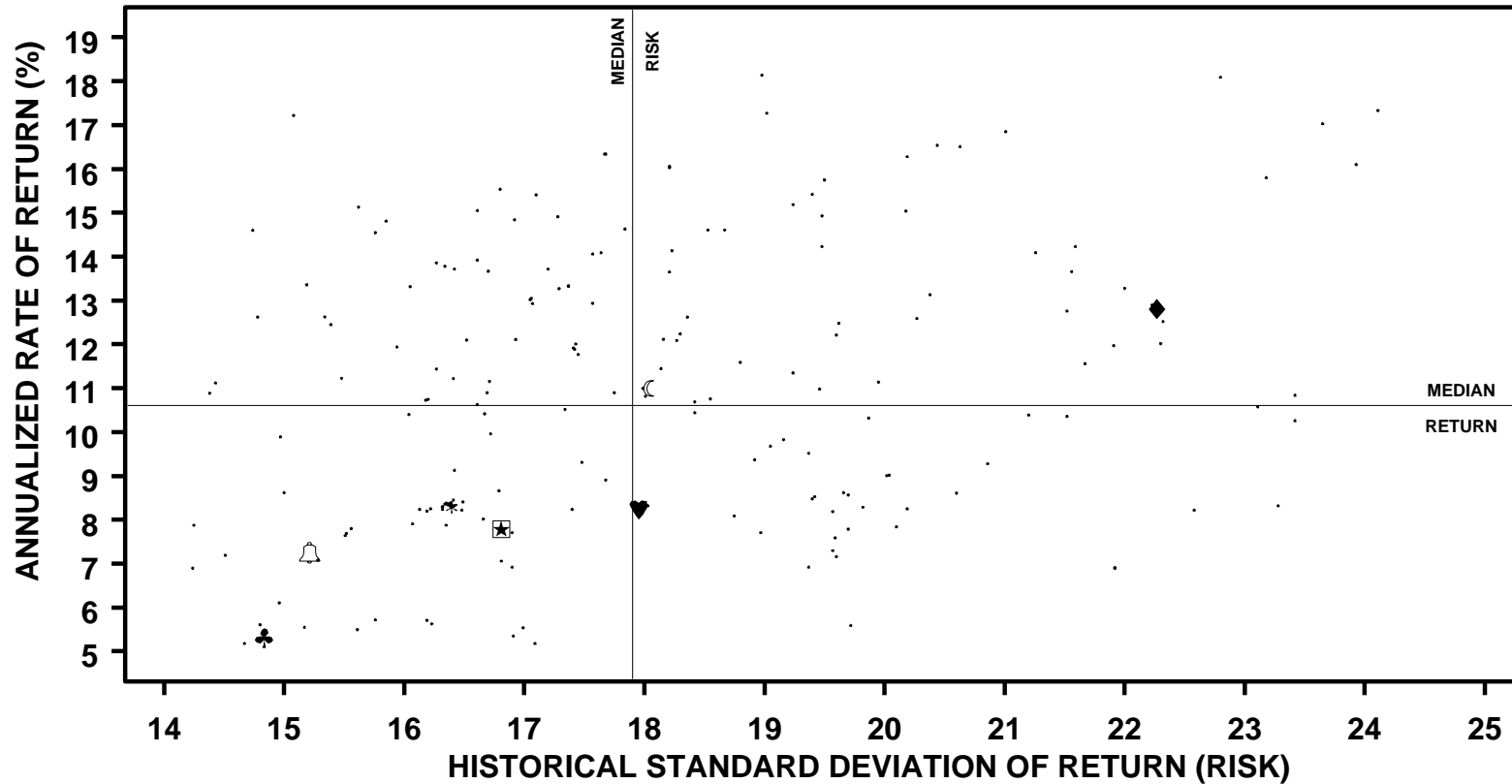

	ANNUALIZED RETURN		STANDARD DEVIATION		SHARPE RATIO	
	VALUE	RANK	VALUE	RANK	VALUE	RANK
★ MUNI COMPOSITE	7.8	80	16.8	62	0.4	77
□ EQTY COMPOSITE	7.8	80	16.8	62	0.4	77
♥ DELAWARE	8.2	75	18.0	49	0.5	74
♣ ALLIANCE	5.3	93	14.8	91	0.3	92
* S&P 500	8.3	74	16.4	70	0.5	65
🔔 R 1000(R) GR	7.3	85	15.2	88	0.4	78
☾ R 1000(R) VALUE	11.0	46	18.0	48	0.6	44
◆ R 2000(R)	12.8	32	22.3	12	0.6	44
MEDIAN	10.6		17.9		0.6	

VERMONT MUNICIPAL EMPLOYEES

EQUITY ONLY PUBLIC FUNDS - RETURN VS RISK

3 YEARS ENDING 6/05

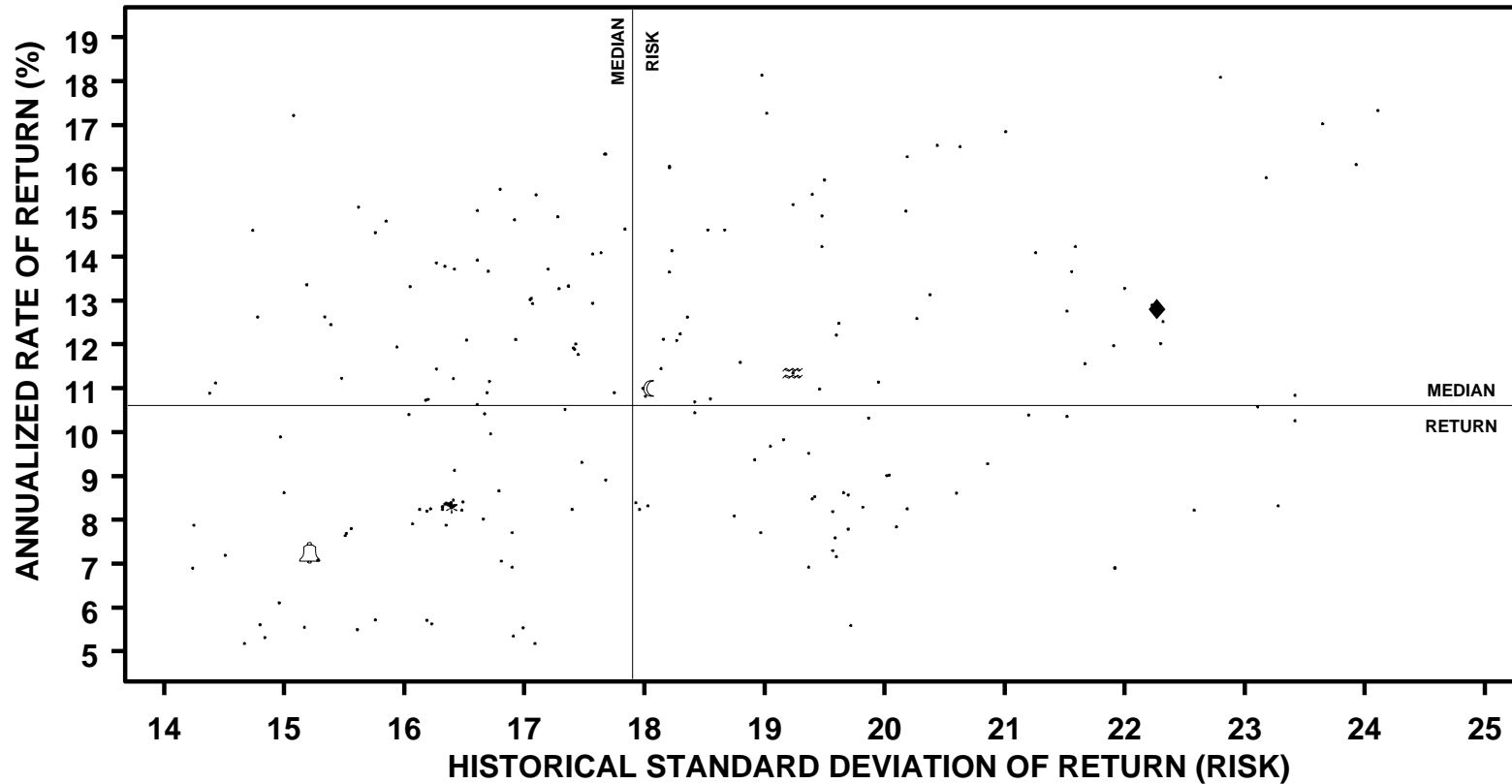

	ANNUALIZED RETURN		STANDARD DEVIATION		SHARPE RATIO	
	VALUE	RANK	VALUE	RANK	VALUE	RANK
≈ LAZARD	11.4	43	19.2	36	0.6	46
* S&P 500	8.3	74	16.4	70	0.5	65
🔔 R 1000(R) GR	7.3	85	15.2	88	0.4	78
☾ R 1000(R) VALUE	11.0	46	18.0	48	0.6	44
◆ R 2000(R)	12.8	32	22.3	12	0.6	44
MEDIAN	10.6		17.9		0.6	

VERMONT MUNICIPAL EMPLOYEES

EQUITY ONLY PUBLIC FUNDS - RETURN VS RISK

5 YEARS ENDING 6/05

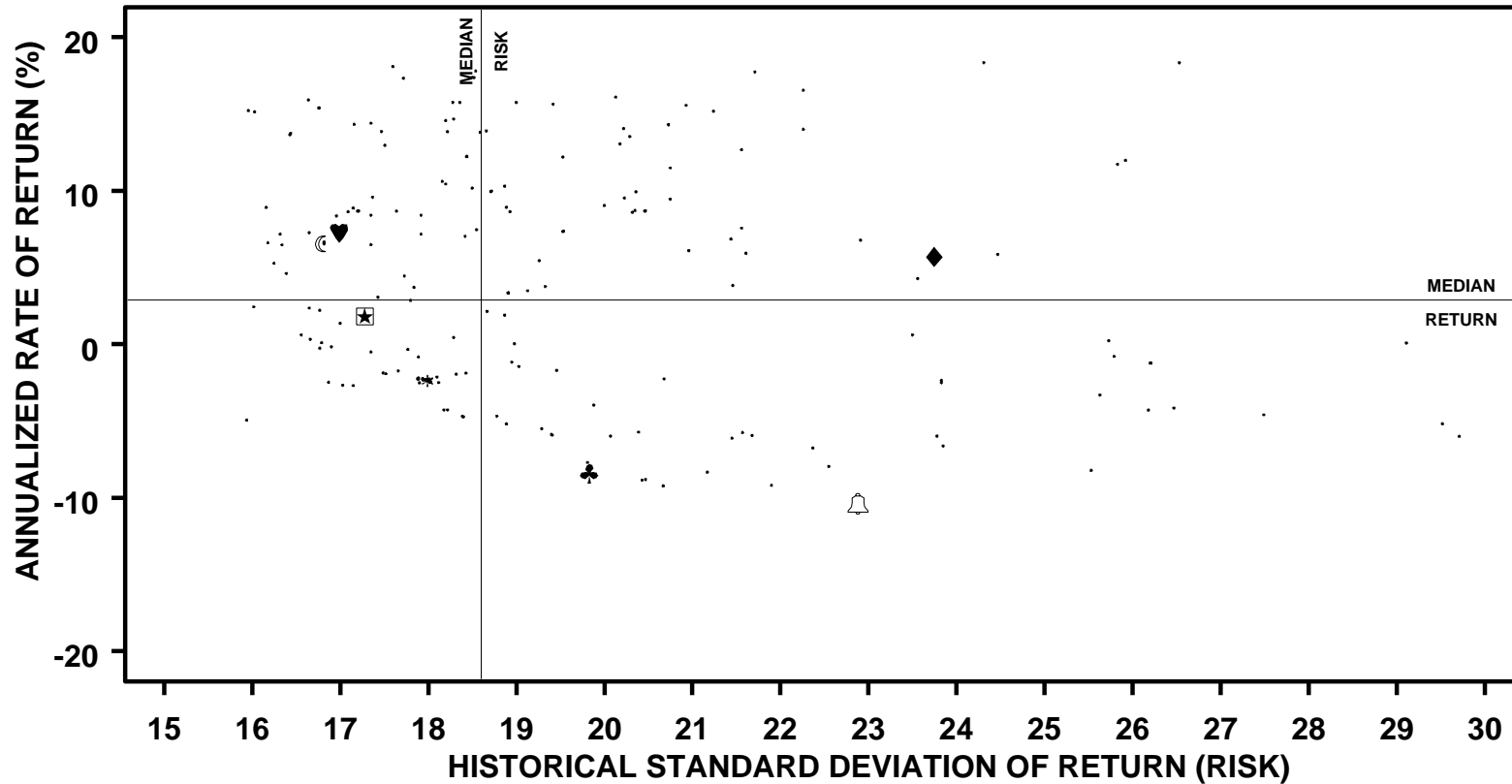

	ANNUALIZED RETURN		STANDARD DEVIATION		SHARPE RATIO	
	VALUE	RANK	VALUE	RANK	VALUE	RANK
★ MUNI COMPOSITE	1.8	52	17.3	78	0.0	54
□ EQTY COMPOSITE	1.8	52	17.3	78	0.0	54
♥ DELAWARE	7.3	36	17.0	82	0.3	35
♣ ALLIANCE	-8.4	93	19.8	37	-0.5	
* S&P 500	-2.4	73	18.0	61	-0.2	
🔔 R 1000(R) GR	-10.4	95	22.9	19	-0.5	
☾ R 1000(R) VALUE	6.6	40	16.8	85	0.3	38
◆ R 2000(R)	5.7	43	23.7	17	0.2	42
MEDIAN	2.9		18.6		0.1	

VERMONT MUNICIPAL EMPLOYEES

EQUITY ONLY PUBLIC FUNDS - RETURN VS RISK

5 YEARS ENDING 6/05

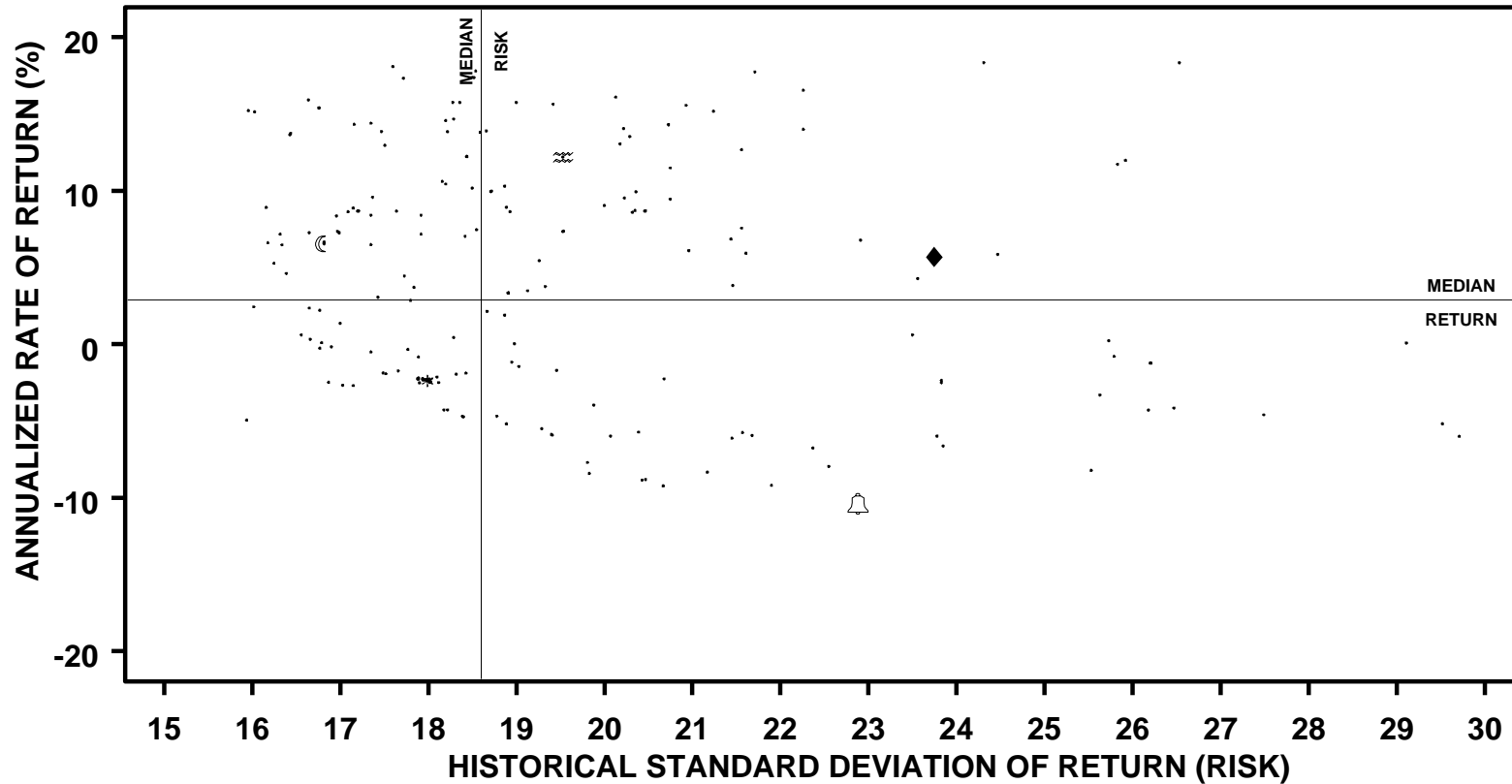

	ANNUALIZED RETURN		STANDARD DEVIATION		SHARPE RATIO	
	VALUE	RANK	VALUE	RANK	VALUE	RANK
≈ LAZARD	12.2	20	19.5	38	0.6	20
* S&P 500	-2.4	73	18.0	61	-0.2	
🔔 R 1000(R) GR	-10.4	95	22.9	19	-0.5	
☾ R 1000(R) VALUE	6.6	40	16.8	85	0.3	38
◆ R 2000(R)	5.7	43	23.7	17	0.2	42
MEDIAN	2.9		18.6		0.1	

VERMONT MUNICIPAL EMPLOYEES

BOND LARGE FUNDS - TOTAL RATES OF RETURN

PERIODS ENDING 6/05

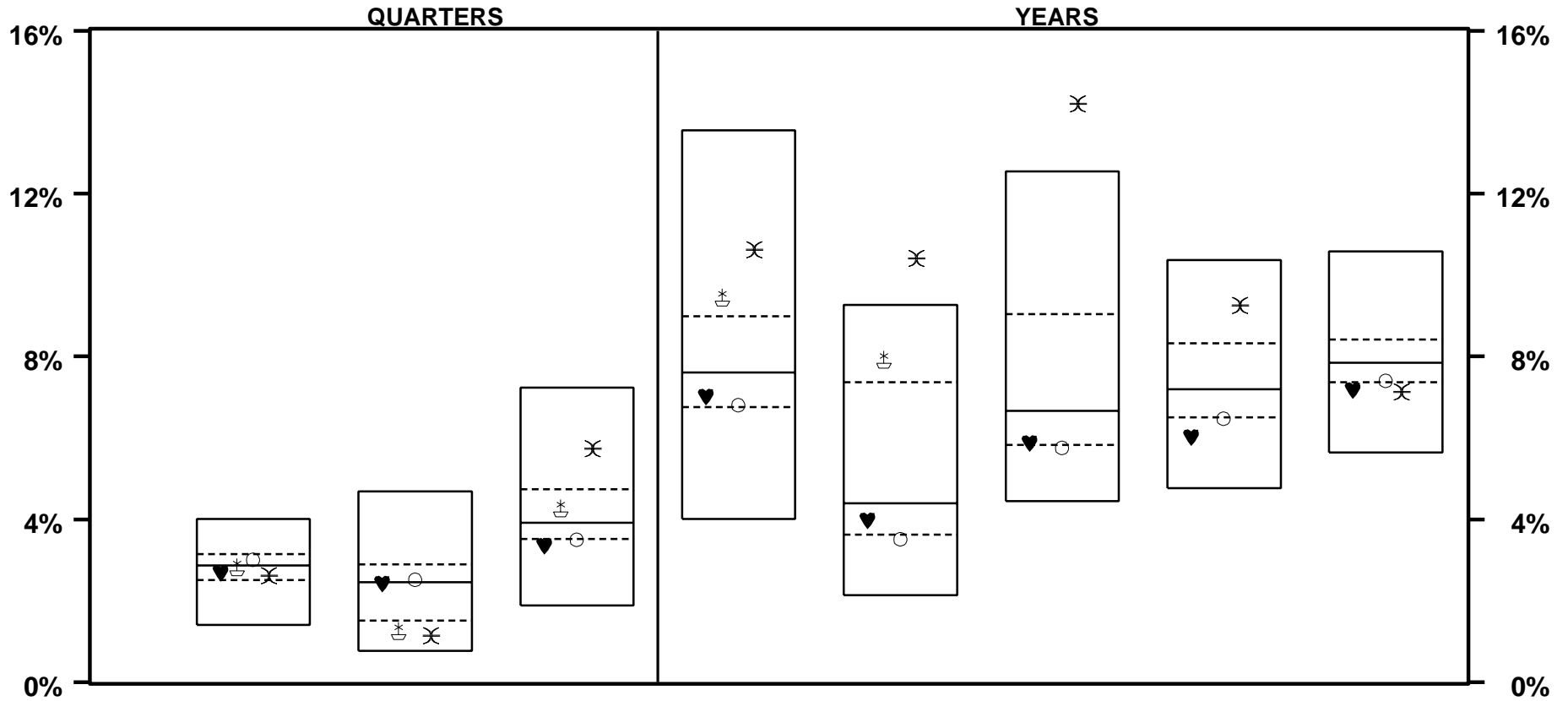

	LAST QTR		LAST 2 QTRS		LAST 3 QTRS		LAST YEAR		LAST 2 YEARS		LAST 3 YEARS		LAST 4 YEARS		LAST 5 YEARS	
♥ SEIX CORE	2.7	62	2.4	51	3.4	81	7.0	64	4.0	63	5.9	74	6.0	88	7.2	82
⊠ SEIX HIGH YIELD	2.8	53	1.3	80	4.3	36	9.5	14	7.9	22						
○ LB AGGREGATE	3.0	41	2.5	40	3.5	75	6.8	71	3.5	80	5.8	82	6.5	76	7.4	73
✕ ML HIGH YLD II	2.6	65	1.1	82	5.7	12	10.6	9	10.4	1	14.2	1	9.3	13	7.1	83
MEDIAN	2.9		2.5		3.9		7.6		4.4		6.7		7.2		7.8	

VERMONT MUNICIPAL EMPLOYEES

BOND LARGE FUNDS - TOTAL RATES OF RETURN

YEARS ENDING

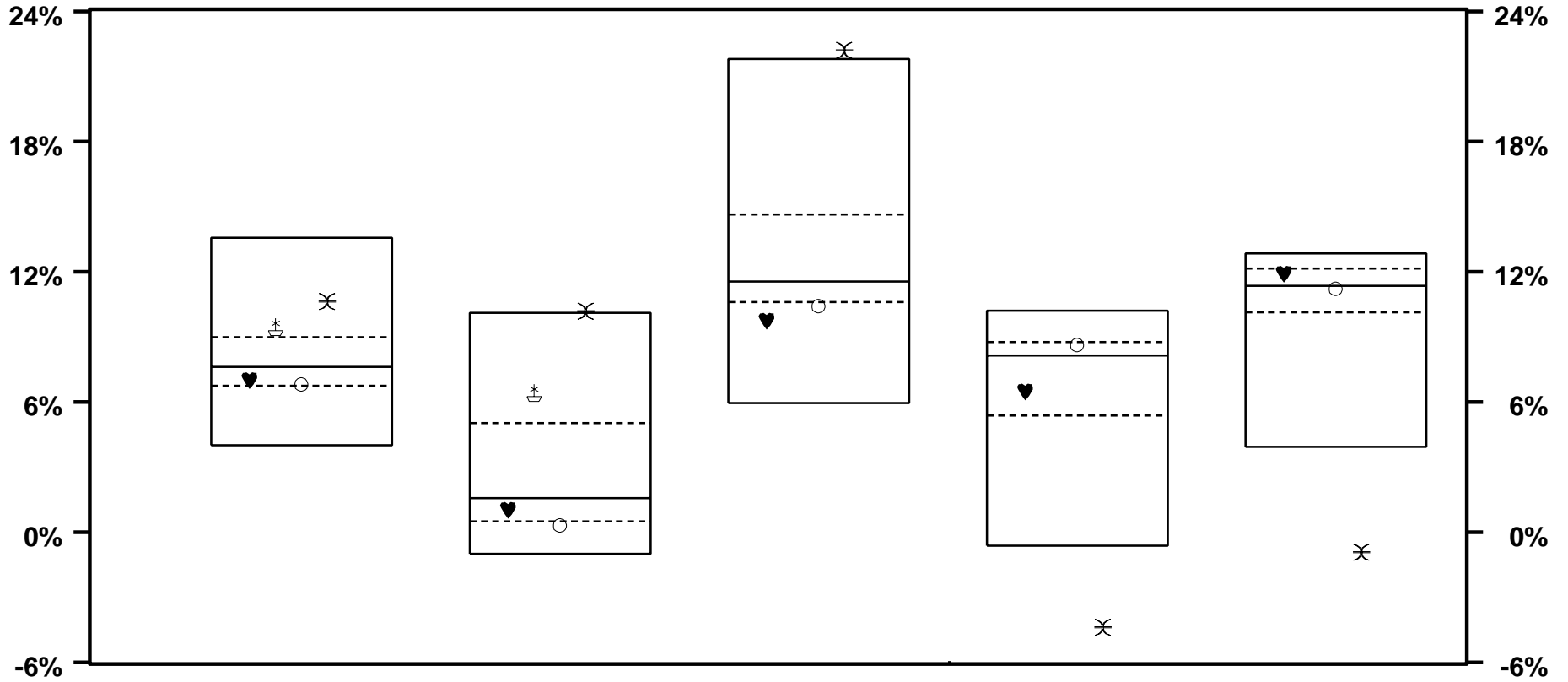

	6 / 05		6 / 04		6 / 03		6 / 02		6 / 01	
♥ SEIX CORE	7.0	64	1.0	58	9.8	85	6.5	65	11.9	32
♣ SEIX HIGH YIELD	9.5	14	6.4	23						
○ LB AGGREGATE	6.8	71	0.3	80	10.4	81	8.6	34	11.2	54
✕ ML HIGH YLD II	10.6	9	10.2	4	22.2	4	-4.4	99	-0.9	97
MEDIAN	7.6		1.6		11.5		8.1		11.3	

VERMONT MUNICIPAL EMPLOYEES

BOND LARGE FUNDS - TOTAL RETURN VS RISK

3 YEARS ENDING 6/05

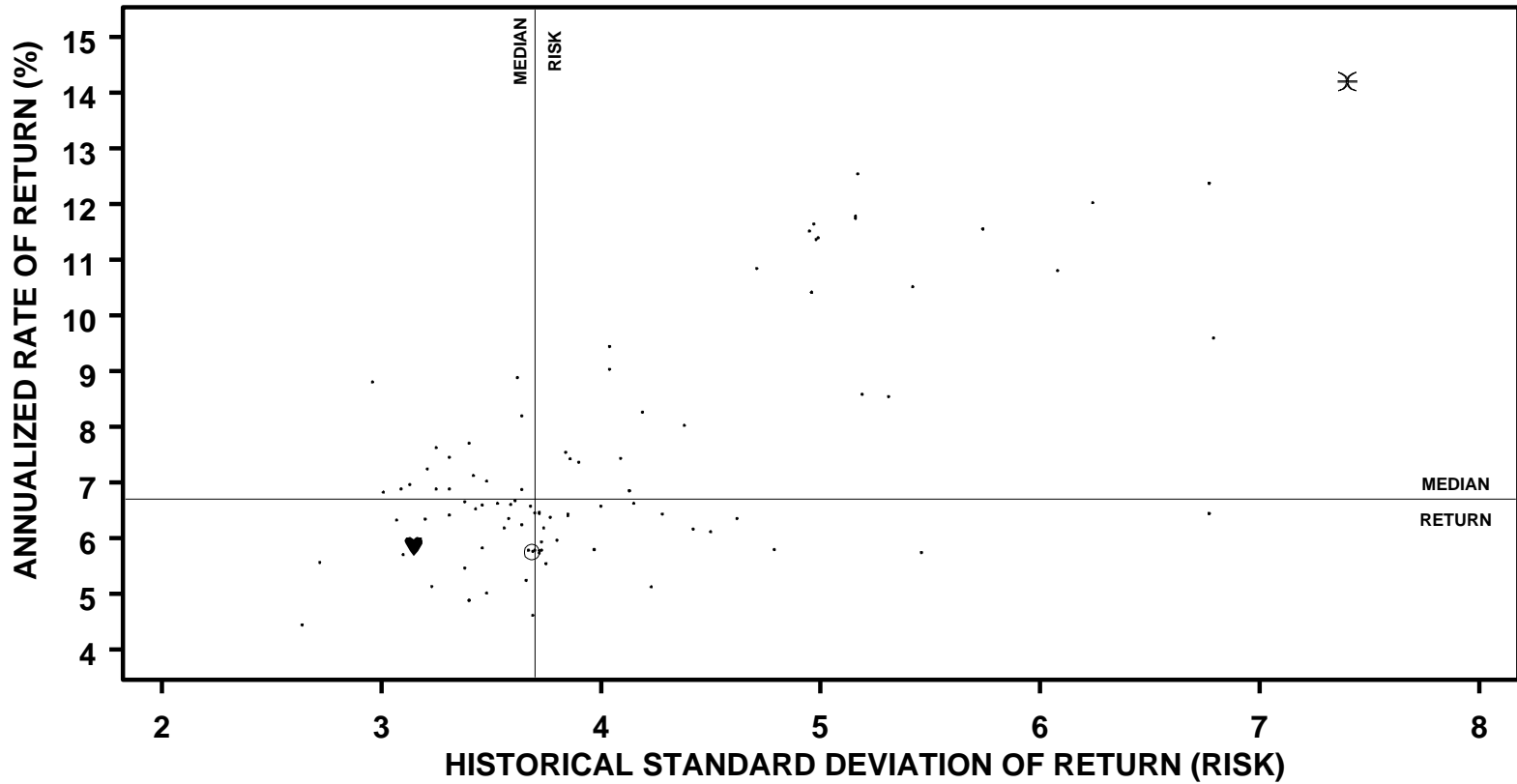

	ANNUALIZED RETURN		STANDARD DEVIATION		SHARPE RATIO	
	VALUE	RANK	VALUE	RANK	VALUE	RANK
♥ SEIX CORE	5.9	74	3.1	86	1.3	49
○ LB AGGREGATE	5.8	82	3.7	58	1.1	72
⌘ ML HIGH YLD II	14.2	1	7.4	4	1.7	24
MEDIAN	6.7		3.7		1.3	

VERMONT MUNICIPAL EMPLOYEES

BOND LARGE FUNDS - TOTAL RETURN VS RISK

5 YEARS ENDING 6/05

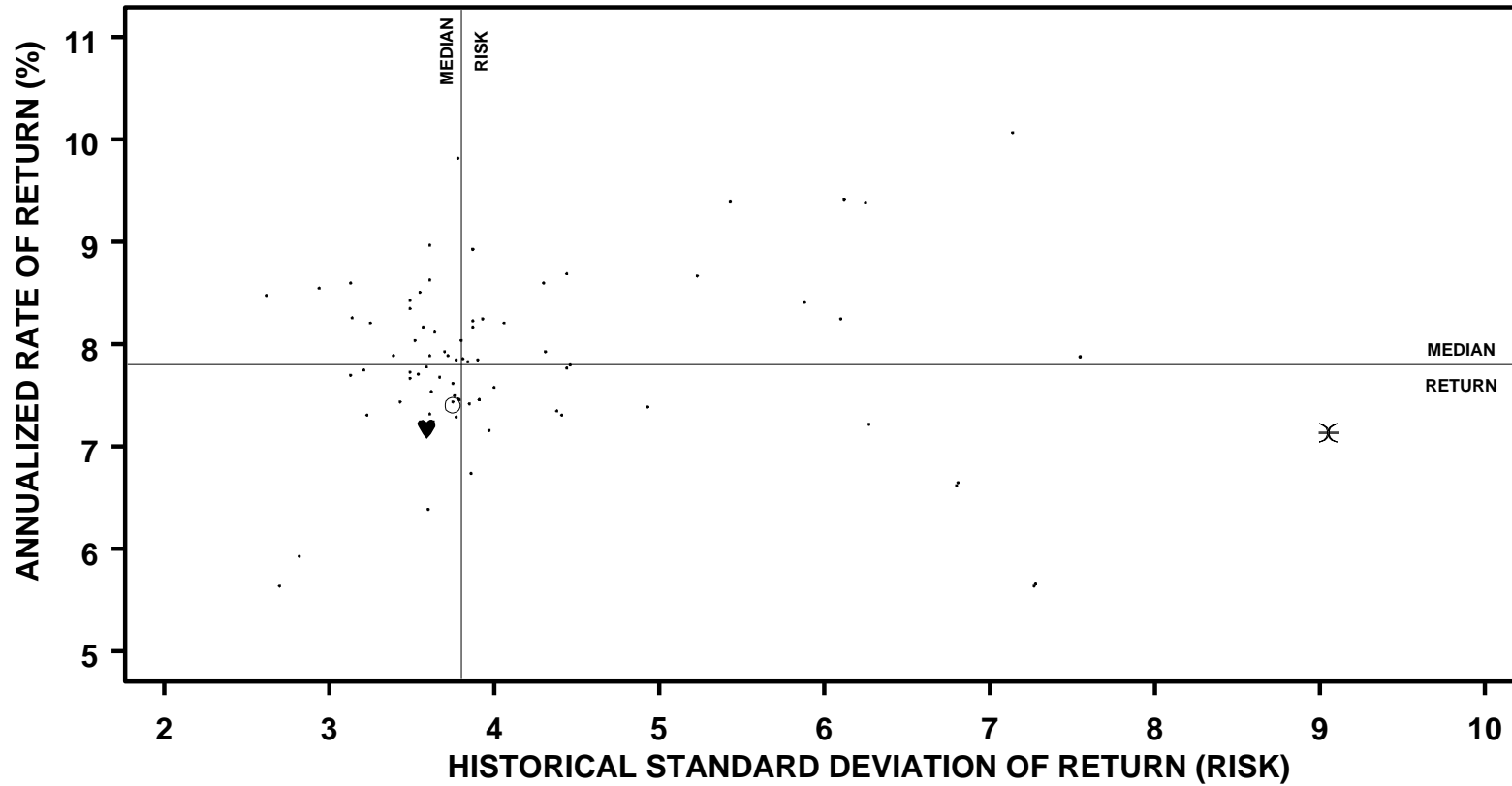

	ANNUALIZED RETURN		STANDARD DEVIATION		SHARPE RATIO	
	VALUE	RANK	VALUE	RANK	VALUE	RANK
♥ SEIX CORE	7.2	82	3.6	72	1.2	54
○ LB AGGREGATE	7.4	73	3.8	58	1.2	53
⌘ ML HIGH YLD II	7.1	83	9.1	2	0.5	92
MEDIAN	7.8		3.8		1.3	

VERMONT MUNICIPAL EMPLOYEES

BOND PUBLIC FUNDS - TOTAL RATES OF RETURN

PERIODS ENDING 6/05

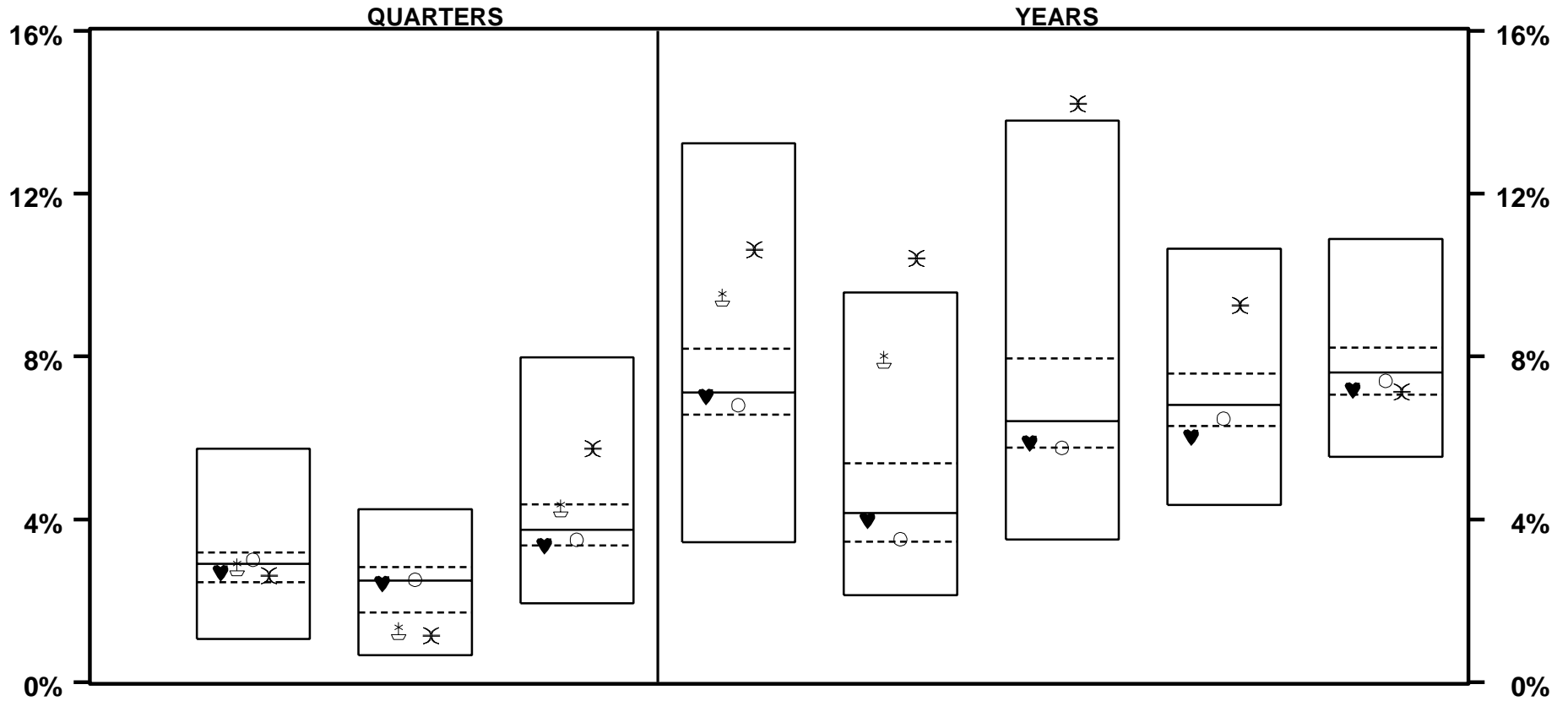

	LAST QTR		LAST 2 QTRS		LAST 3 QTRS		LAST YEAR		LAST 2 YEARS		LAST 3 YEARS		LAST 4 YEARS		LAST 5 YEARS	
♥ SEIX CORE	2.7	63	2.4	54	3.4	75	7.0	53	4.0	54	5.9	70	6.0	80	7.2	72
⊕ SEIX HIGH YIELD	2.8	55	1.3	83	4.3	27	9.5	12	7.9	14						
○ LB AGGREGATE	3.0	41	2.5	45	3.5	65	6.8	65	3.5	71	5.8	75	6.5	66	7.4	62
✖ ML HIGH YLD II	2.6	67	1.1	85	5.7	10	10.6	8	10.4	3	14.2	3	9.3	11	7.1	74
MEDIAN	2.9		2.5		3.7		7.1		4.2		6.4		6.8		7.6	

VERMONT MUNICIPAL EMPLOYEES

BOND PUBLIC FUNDS - TOTAL RATES OF RETURN

YEARS ENDING

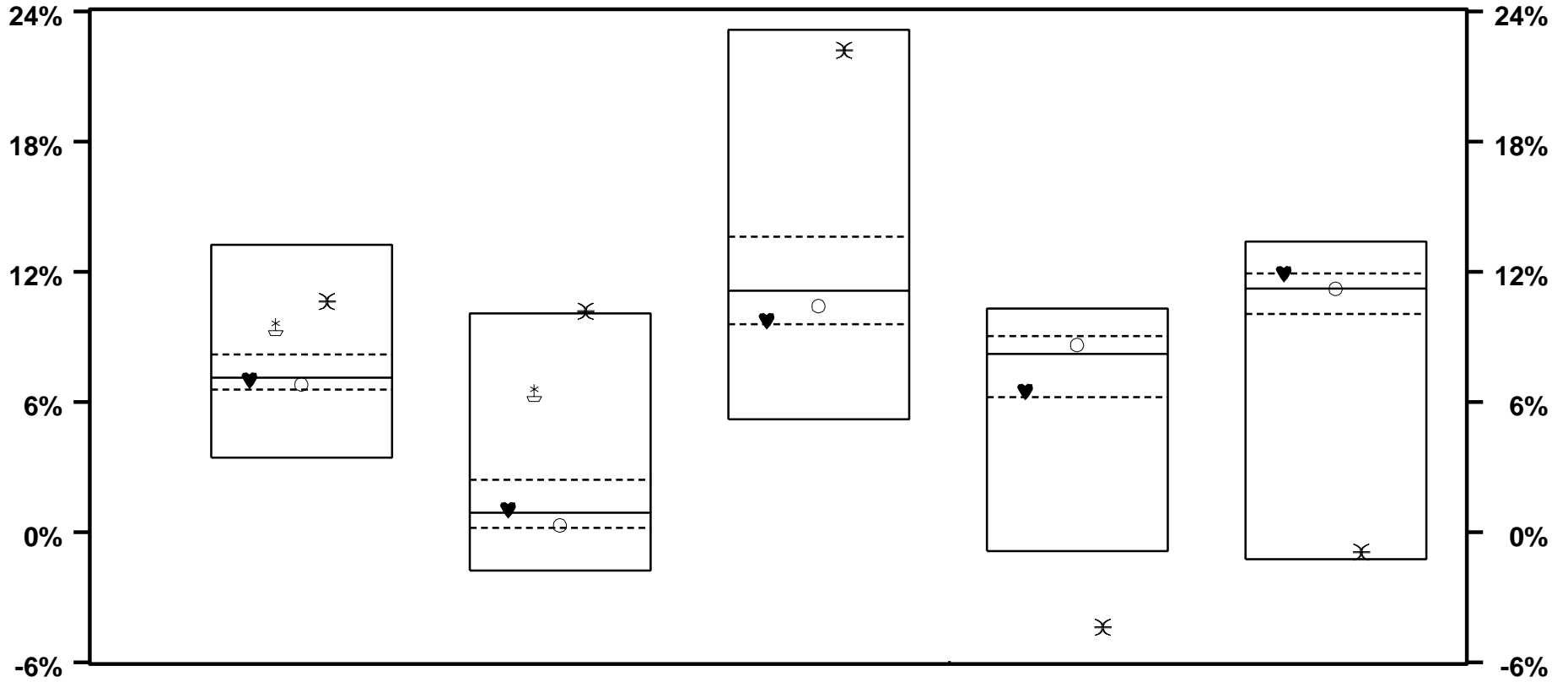

	6 / 05		6 / 04		6 / 03		6 / 02		6 / 01	
♥ SEIX CORE	7.0	53	1.0	47	9.8	73	6.5	73	11.9	25
♣ SEIX HIGH YIELD	9.5	12	6.4	14						
○ LB AGGREGATE	6.8	65	0.3	69	10.4	65	8.6	36	11.2	48
✕ ML HIGH YLD II	10.6	8	10.2	4	22.2	5	-4.4	97	-0.9	94
MEDIAN	7.1		0.9		11.1		8.2		11.2	

VERMONT MUNICIPAL EMPLOYEES

BOND PUBLIC FUNDS - TOTAL RETURN VS RISK

3 YEARS ENDING 6/05

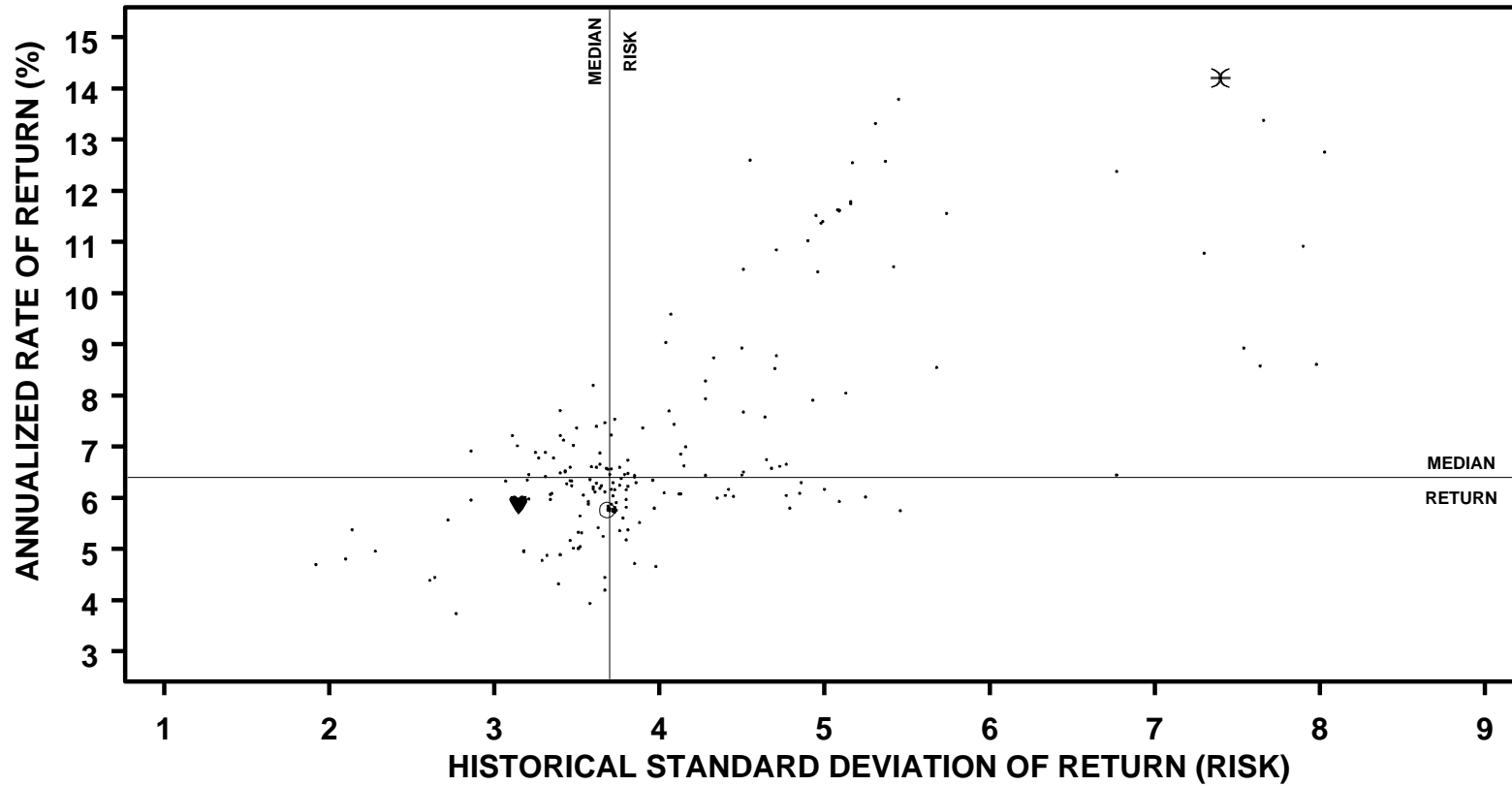

	ANNUALIZED RETURN		STANDARD DEVIATION		SHARPE RATIO	
	VALUE	RANK	VALUE	RANK	VALUE	RANK
♥ SEIX CORE	5.9	70	3.1	84	1.3	40
○ LB AGGREGATE	5.8	75	3.7	58	1.1	66
⌘ ML HIGH YLD II	14.2	3	7.4	10	1.7	17
MEDIAN	6.4		3.7		1.3	

VERMONT MUNICIPAL EMPLOYEES

BOND PUBLIC FUNDS - TOTAL RETURN VS RISK

5 YEARS ENDING 6/05

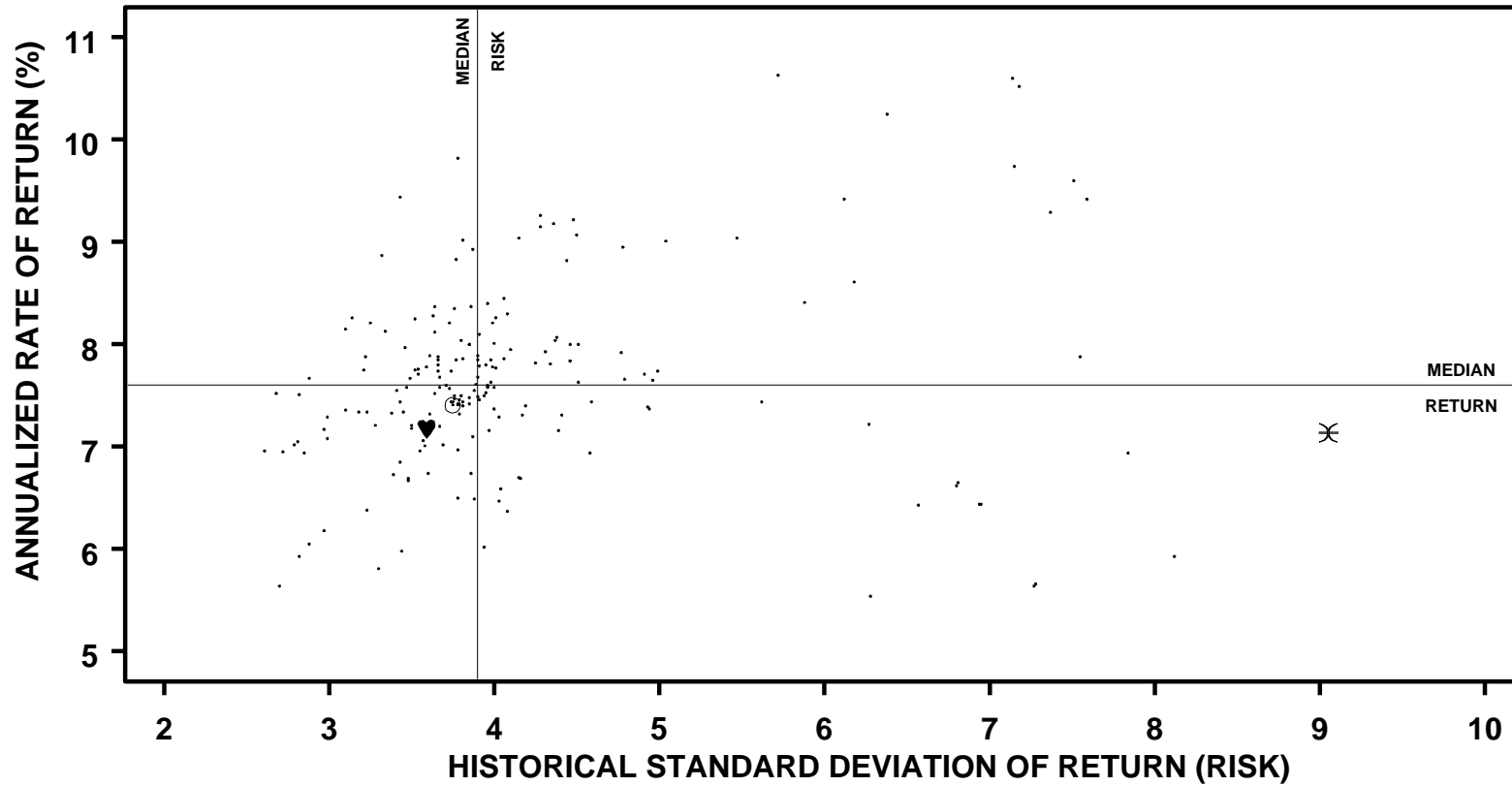

	ANNUALIZED RETURN		STANDARD DEVIATION		SHARPE RATIO	
	VALUE	RANK	VALUE	RANK	VALUE	RANK
♥ SEIX CORE	7.2	72	3.6	71	1.2	47
○ LB AGGREGATE	7.4	62	3.8	59	1.2	45
⊗ ML HIGH YLD II	7.1	74	9.1	3	0.5	94
MEDIAN	7.6		3.9		1.2	

VERMONT MUNICIPAL EMPLOYEES

BOND ONLY LARGE FUNDS - RATES OF RETURN

PERIODS ENDING 6/05

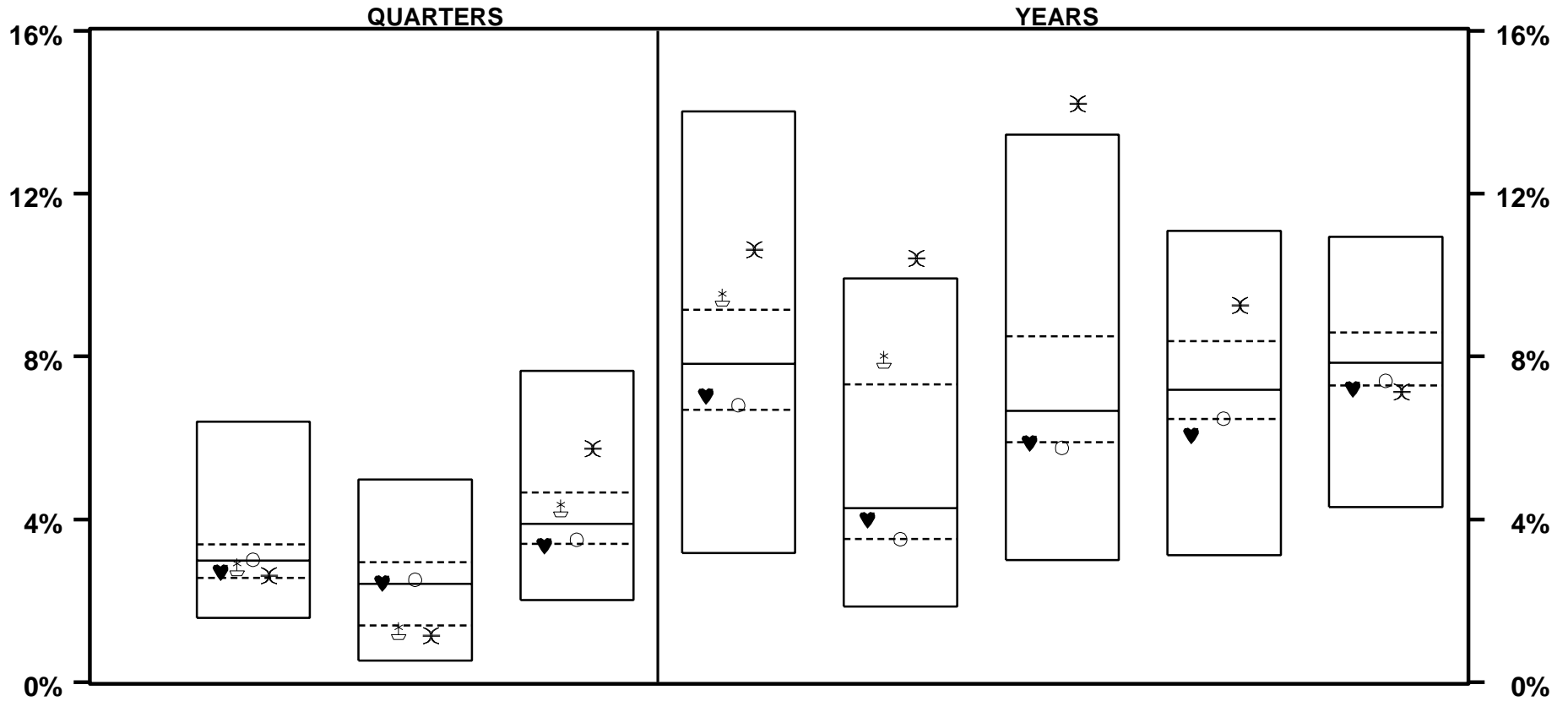

	LAST QTR		LAST 2 QTRS		LAST 3 QTRS		LAST YEAR		LAST 2 YEARS		LAST 3 YEARS		LAST 4 YEARS		LAST 5 YEARS	
♥ SEIX CORE	2.7	61	2.4	45	3.4	76	7.0	63	4.0	60	5.9	75	6.1	82	7.2	75
⊠ SEIX HIGH YIELD	2.8	56	1.3	78	4.3	34	9.5	16	7.9	21						
○ LB AGGREGATE	3.0	47	2.5	38	3.5	68	6.8	67	3.5	75	5.8	83	6.5	73	7.4	72
⊗ ML HIGH YLD II	2.6	74	1.1	80	5.7	13	10.6	9	10.4	3	14.2	2	9.3	16	7.1	75
MEDIAN	3.0		2.4		3.9		7.8		4.3		6.7		7.2		7.8	

VERMONT MUNICIPAL EMPLOYEES

BOND ONLY LARGE FUNDS - RATES OF RETURN

YEARS ENDING

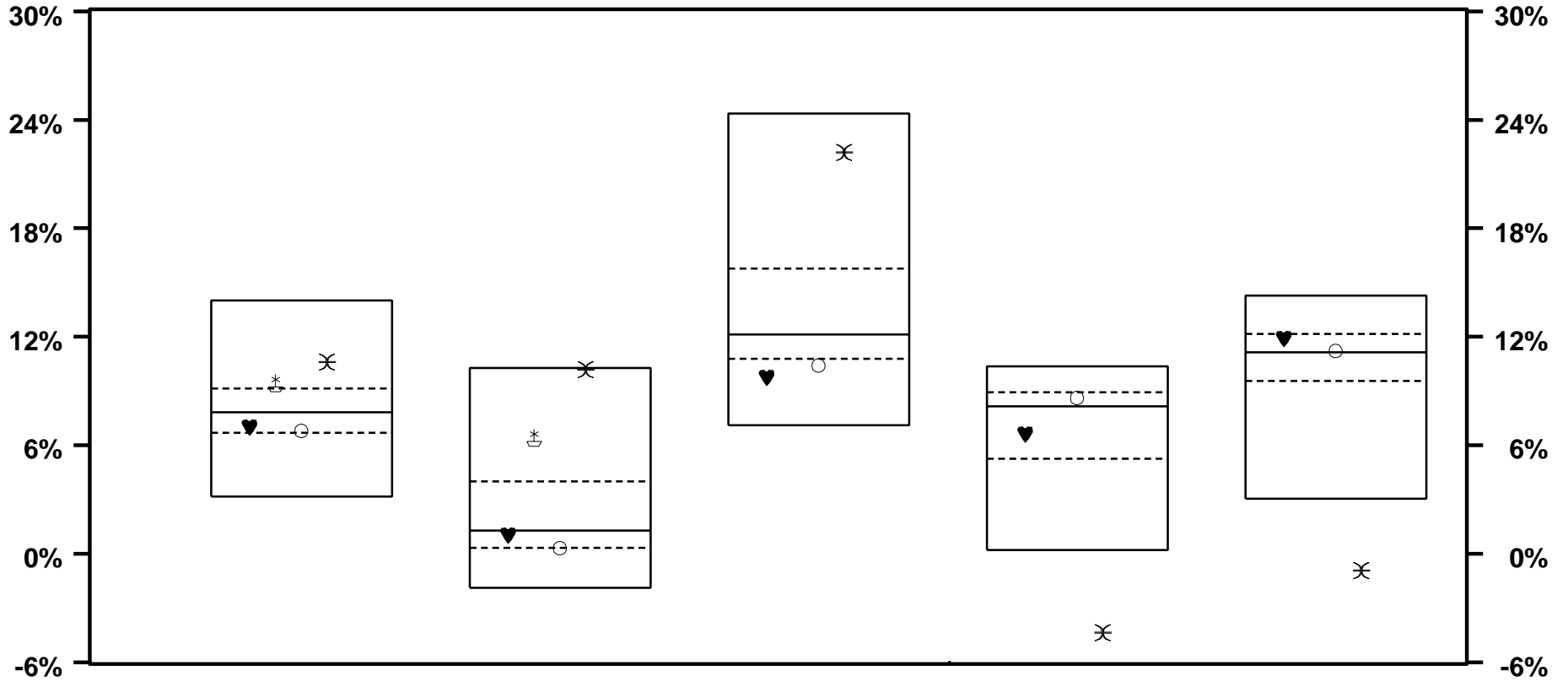

	6 / 05		6 / 04		6 / 03		6 / 02		6 / 01	
♥ SEIX CORE	7.0	63	1.0	53	9.8	87	6.6	63	11.9	29
⊕ SEIX HIGH YIELD	9.5	16	6.4	21						
○ LB AGGREGATE	6.8	67	0.3	73	10.4	84	8.6	35	11.2	45
⌘ ML HIGH YLD II	10.6	9	10.2	5	22.2	7	-4.4	98	-0.9	97
MEDIAN	7.8		1.3		12.1		8.2		11.1	

VERMONT MUNICIPAL EMPLOYEES

BOND ONLY LARGE FUNDS - RETURN VS RISK

3 YEARS ENDING 6/05

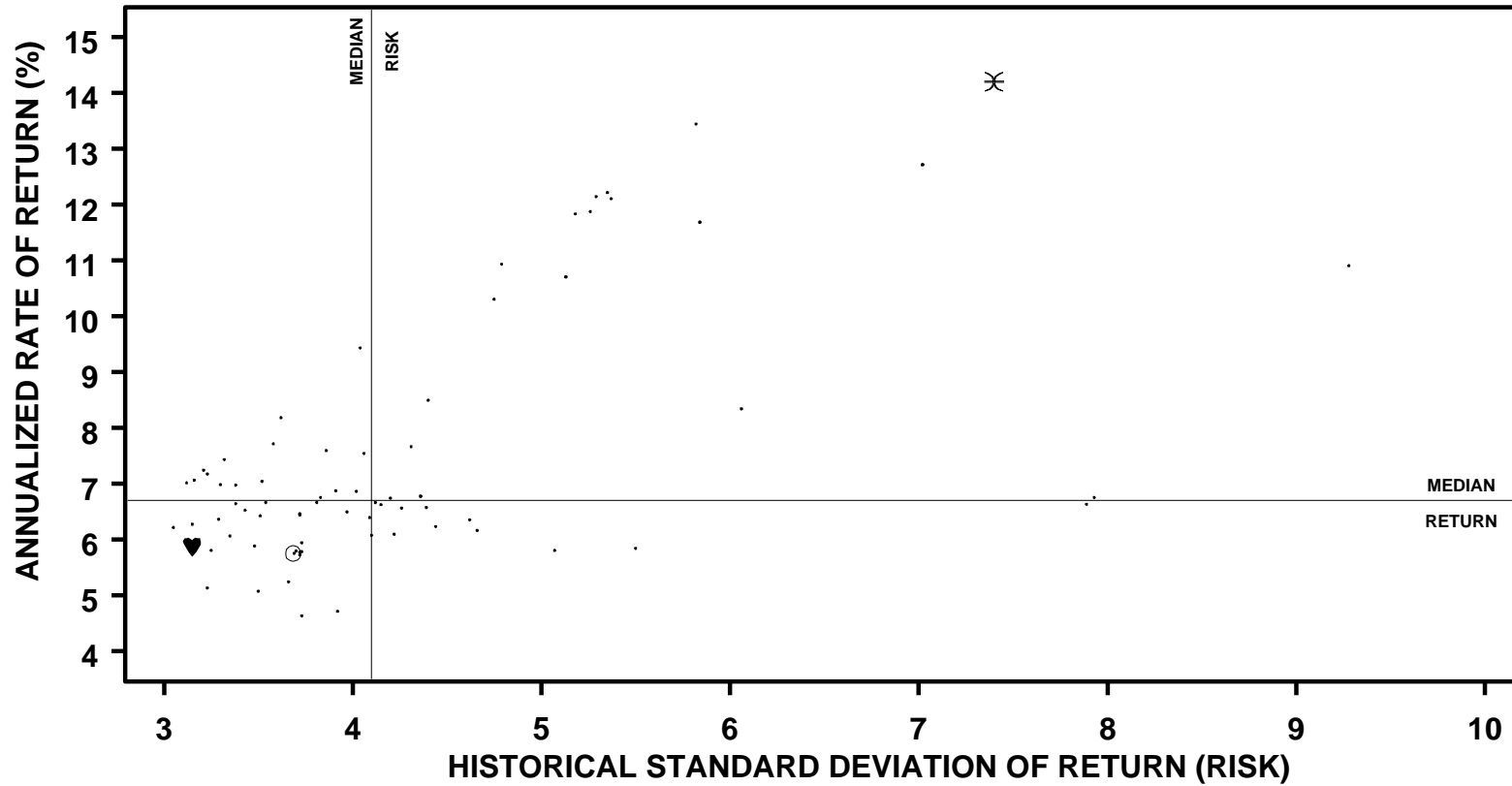

	ANNUALIZED RETURN		STANDARD DEVIATION		SHARPE RATIO	
	VALUE	RANK	VALUE	RANK	VALUE	RANK
♥ SEIX CORE	5.9	75	3.2	92	1.4	44
○ LB AGGREGATE	5.8	83	3.7	69	1.1	65
⊗ ML HIGH YLD II	14.2	2	7.4	11	1.7	24
MEDIAN	6.7		4.1		1.3	

VERMONT MUNICIPAL EMPLOYEES

BOND ONLY LARGE FUNDS - RETURN VS RISK

5 YEARS ENDING 6/05

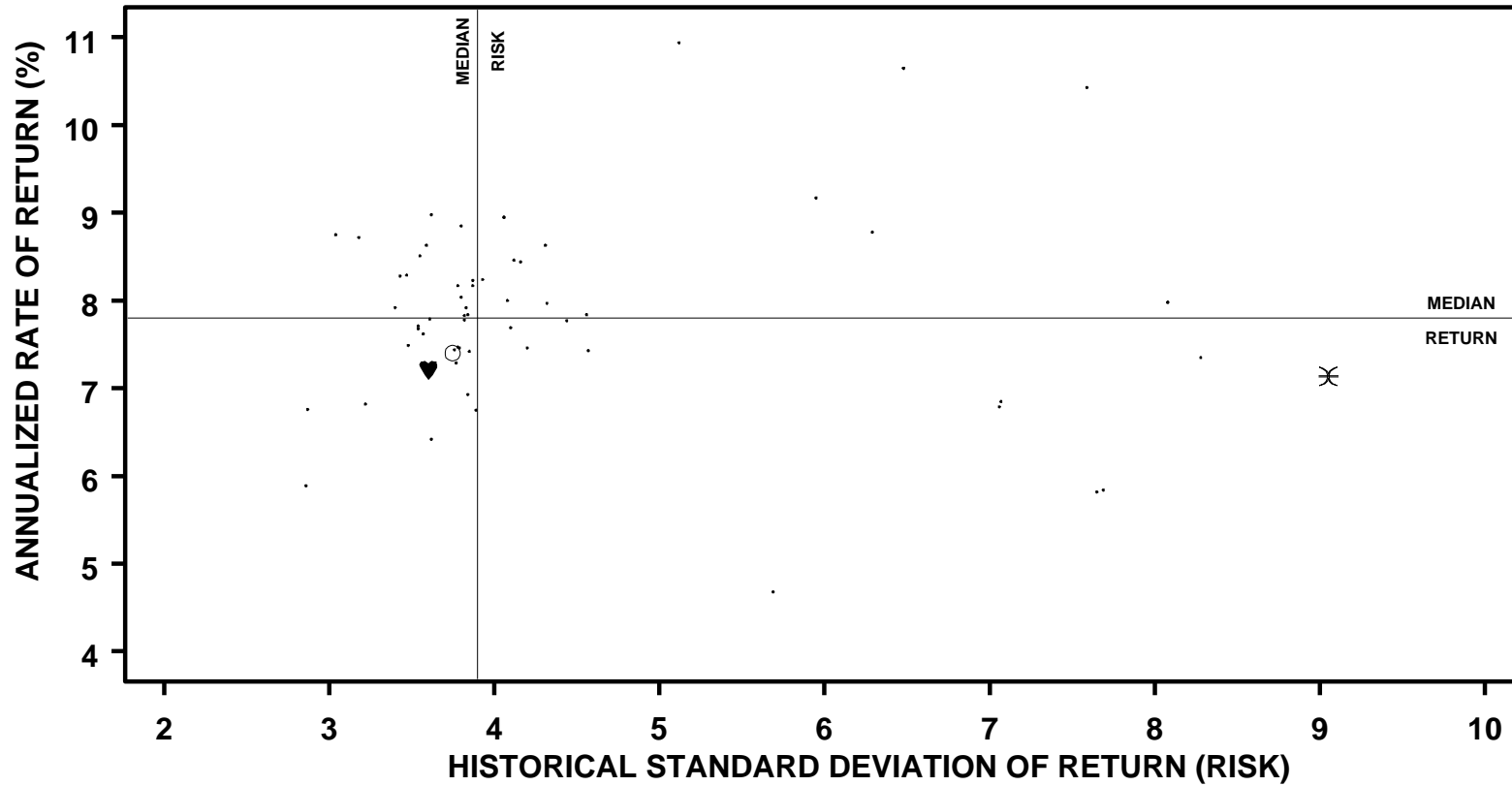

	ANNUALIZED RETURN		STANDARD DEVIATION		SHARPE RATIO	
	VALUE	RANK	VALUE	RANK	VALUE	RANK
♥ SEIX CORE	7.2	75	3.6	74	1.2	49
○ LB AGGREGATE	7.4	72	3.8	70	1.2	49
⊗ ML HIGH YLD II	7.1	75	9.1	3	0.5	89
MEDIAN	7.8		3.9		1.2	

VERMONT MUNICIPAL EMPLOYEES

BOND ONLY PUBLIC FUNDS - RATES OF RETURN

PERIODS ENDING 6/05

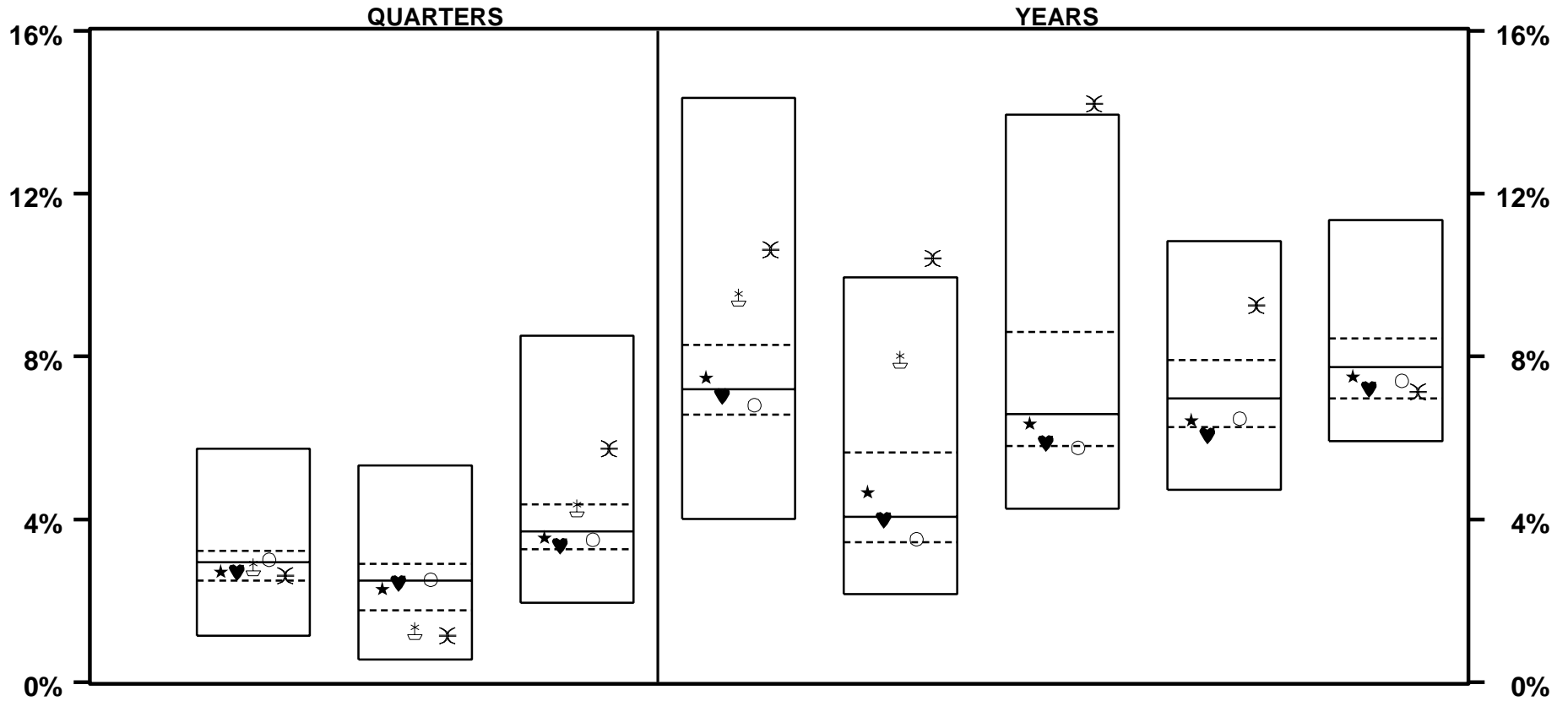

	LAST QTR		LAST 2 QTRS		LAST 3 QTRS		LAST YEAR		LAST 2 YEARS		LAST 3 YEARS		LAST 4 YEARS		LAST 5 YEARS	
★ MUNI COMPOSITE	2.7	63	2.3	60	3.5	58	7.5	42	4.7	36	6.4	58	6.4	70	7.5	57
♥ SEIX CORE	2.7	64	2.4	53	3.4	71	7.0	56	4.0	52	5.9	71	6.1	78	7.2	69
⊠ SEIX HIGH YIELD	2.8	56	1.3	84	4.3	27	9.5	16	7.9	15						
○ LB AGGREGATE	3.0	43	2.5	46	3.5	62	6.8	64	3.5	70	5.8	77	6.5	69	7.4	64
✕ ML HIGH YLD II	2.6	69	1.1	86	5.7	10	10.6	10	10.4	3	14.2	4	9.3	11	7.1	71
MEDIAN	2.9		2.5		3.7		7.2		4.1		6.6		7.0		7.7	

VERMONT MUNICIPAL EMPLOYEES

BOND ONLY PUBLIC FUNDS - RATES OF RETURN

PERIODS ENDING 6/05

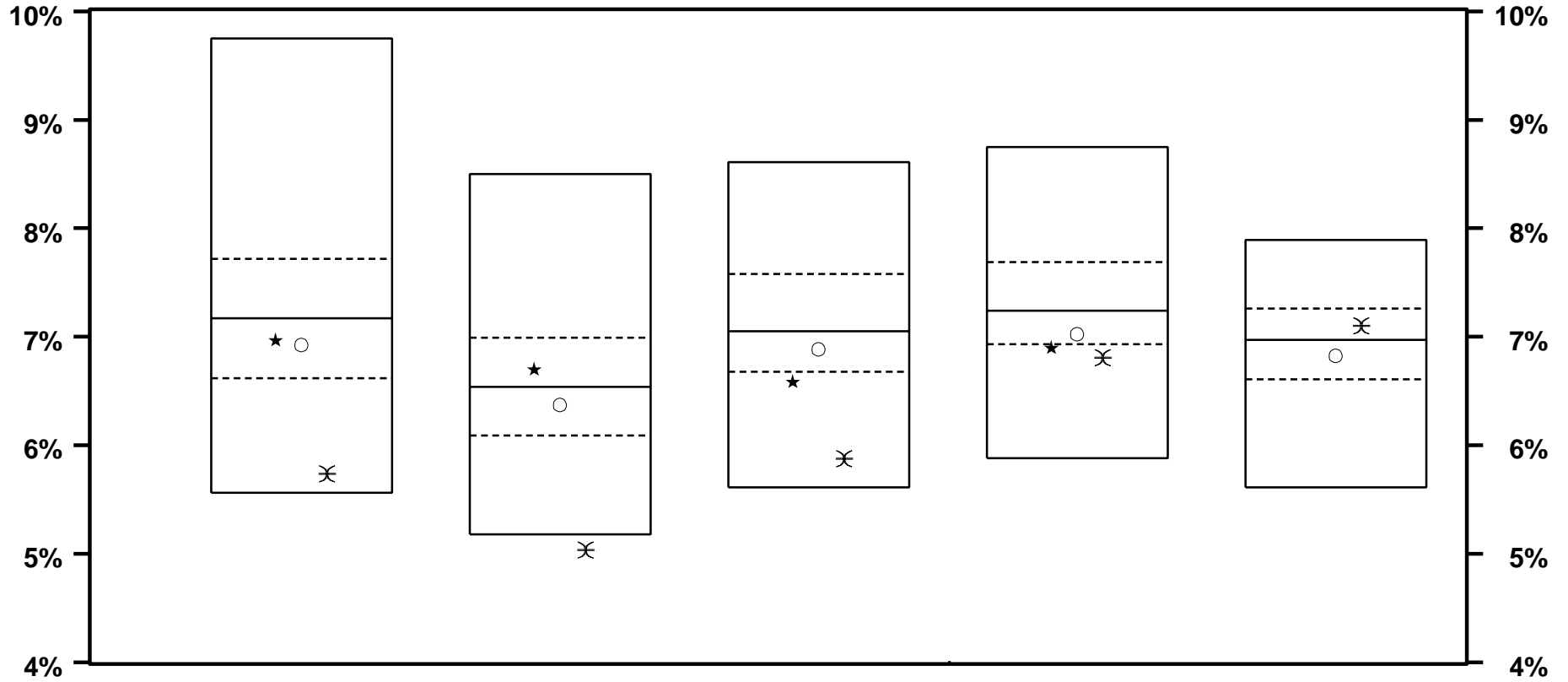

	LAST 6 YEARS		LAST 7 YEARS		LAST 8 YEARS		LAST 9 YEARS		LAST 10 YEARS	
★ MUNI COMPOSITE	7.0	62	6.7	40	6.6	78	6.9	76		
○ LB AGGREGATE	6.9	64	6.4	58	6.9	60	7.0	66	6.8	62
⌘ ML HIGH YLD II	5.7	92	5.0	96	5.9	92	6.8	77	7.1	39
MEDIAN	7.2		6.5		7.0		7.2		7.0	

VERMONT MUNICIPAL EMPLOYEES

BOND ONLY PUBLIC FUNDS - RATES OF RETURN

YEARS ENDING

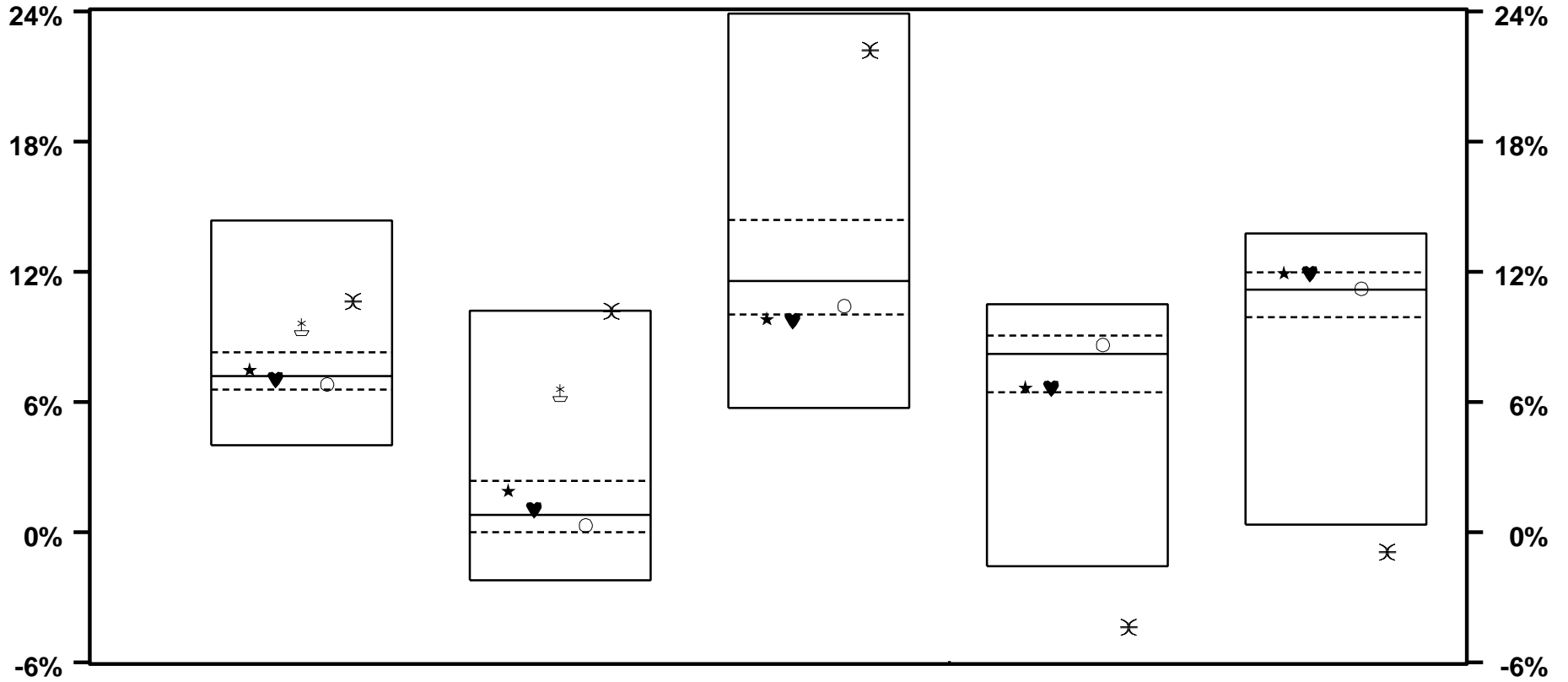

	6 / 05		6 / 04		6 / 03		6 / 02		6 / 01	
★ MUNI COMPOSITE	7.5	42	1.9	30	9.8	76	6.7	72	11.9	26
♥ SEIX CORE	7.0	56	1.0	45	9.8	77	6.6	72	11.9	27
⊠ SEIX HIGH YIELD	9.5	16	6.4	15						
○ LB AGGREGATE	6.8	64	0.3	64	10.4	70	8.6	37	11.2	47
* ML HIGH YLD II	10.6	10	10.2	4	22.2	6	-4.4	97	-0.9	96
MEDIAN	7.2		0.8		11.6		8.2		11.2	

VERMONT MUNICIPAL EMPLOYEES

BOND ONLY PUBLIC FUNDS - RATES OF RETURN

YEARS ENDING

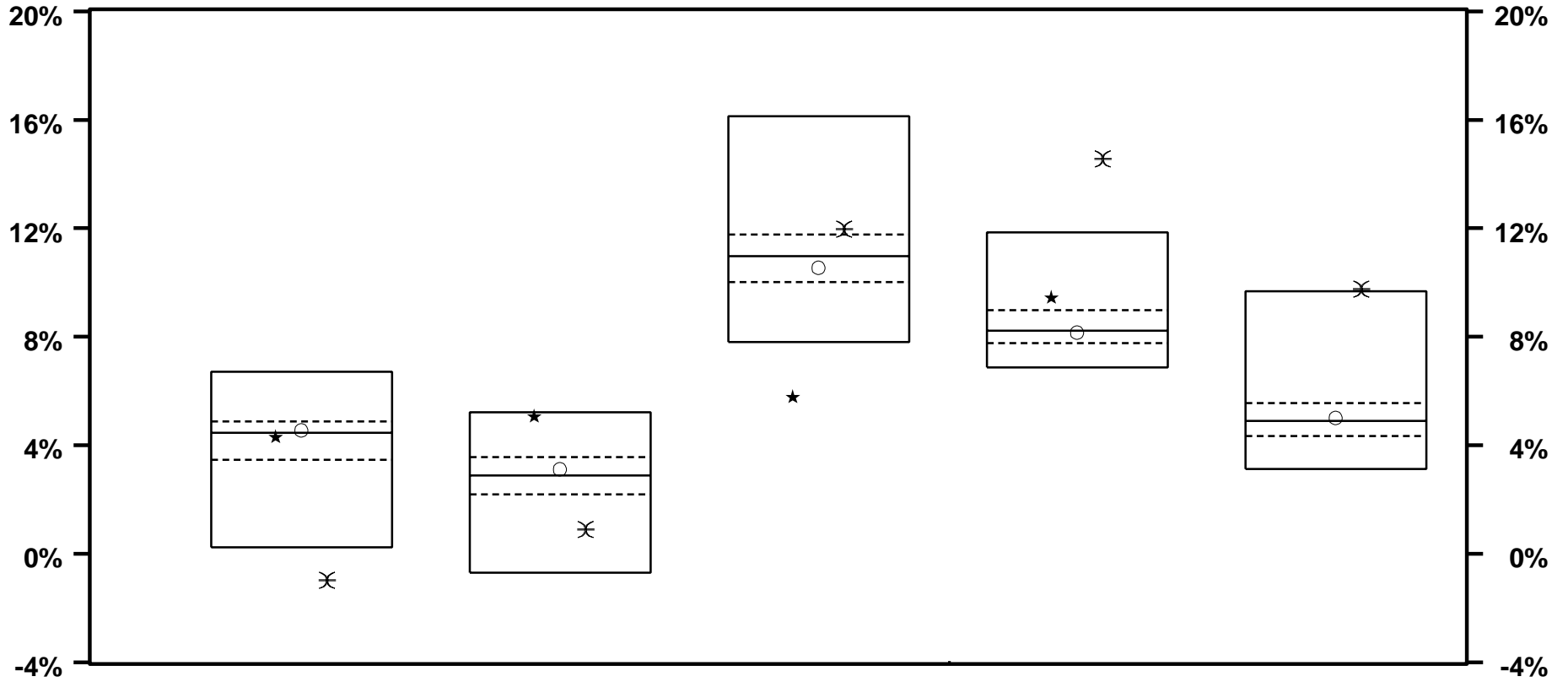

	6 / 00		6 / 99		6 / 98		6 / 97		6 / 96	
★ MUNI COMPOSITE	4.3	54	5.1	5	5.8	99	9.5	15		
○ LB AGGREGATE	4.6	43	3.1	40	10.5	64	8.2	53	5.0	44
✕ ML HIGH YLD II	-1.0	97	0.9	89	12.0	21	14.6	2	9.8	4
MEDIAN	4.5		2.9		11.0		8.2		4.9	

VERMONT MUNICIPAL EMPLOYEES

BOND ONLY PUBLIC FUNDS - RETURN VS RISK

3 YEARS ENDING 6/05

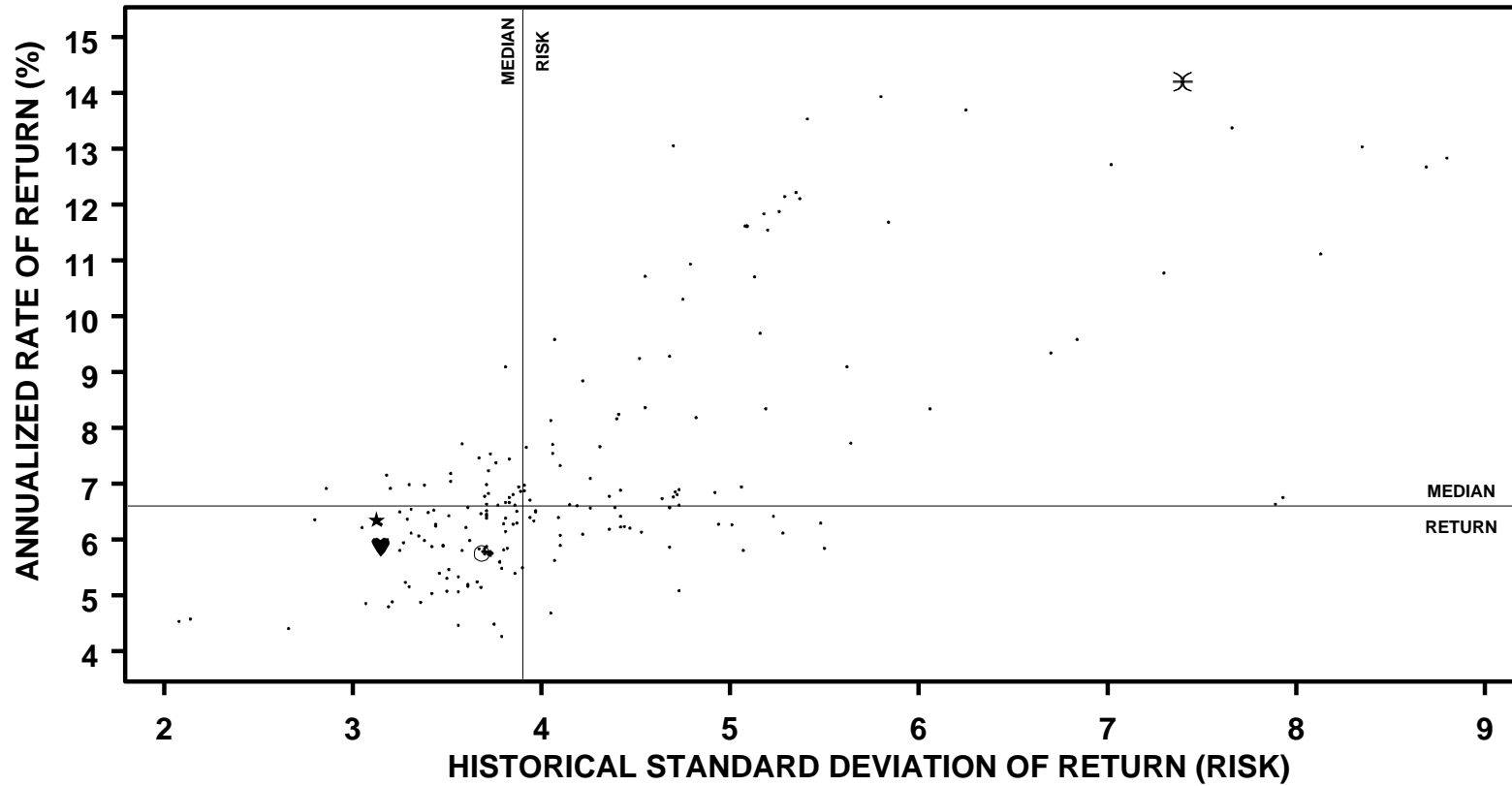

	ANNUALIZED RETURN		STANDARD DEVIATION		SHARPE RATIO	
	VALUE	RANK	VALUE	RANK	VALUE	RANK
★ MUNI COMPOSITE	6.4	58	3.1	88	1.5	24
♥ SEIX CORE	5.9	71	3.2	87	1.4	36
○ LB AGGREGATE	5.8	77	3.7	68	1.1	63
⌘ ML HIGH YLD II	14.2	4	7.4	10	1.7	16
MEDIAN	6.6		3.9		1.2	

VERMONT MUNICIPAL EMPLOYEES

BOND ONLY PUBLIC FUNDS - RETURN VS RISK

5 YEARS ENDING 6/05

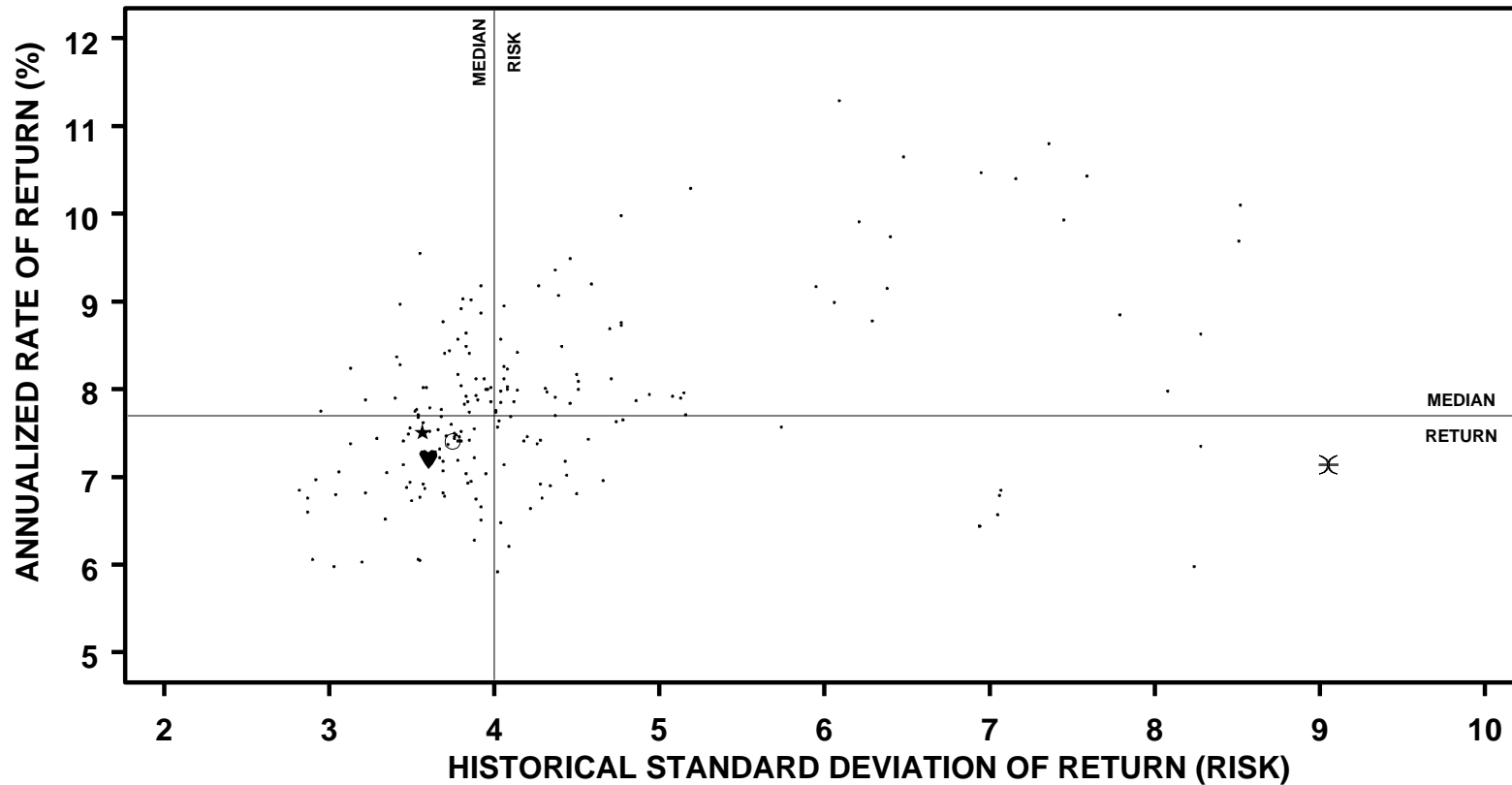

	ANNUALIZED RETURN		STANDARD DEVIATION		SHARPE RATIO	
	VALUE	RANK	VALUE	RANK	VALUE	RANK
★ MUNI COMPOSITE	7.5	57	3.6	78	1.3	29
♥ SEIX CORE	7.2	69	3.6	76	1.2	45
○ LB AGGREGATE	7.4	64	3.8	68	1.2	44
⌘ ML HIGH YLD II	7.1	71	9.1	4	0.5	94
MEDIAN	7.7		4.0		1.2	

VERMONT MUNICIPAL EMPLOYEES

PLAN ALLOCATION BY INVESTMENT MANDATE

AS OF 6/05

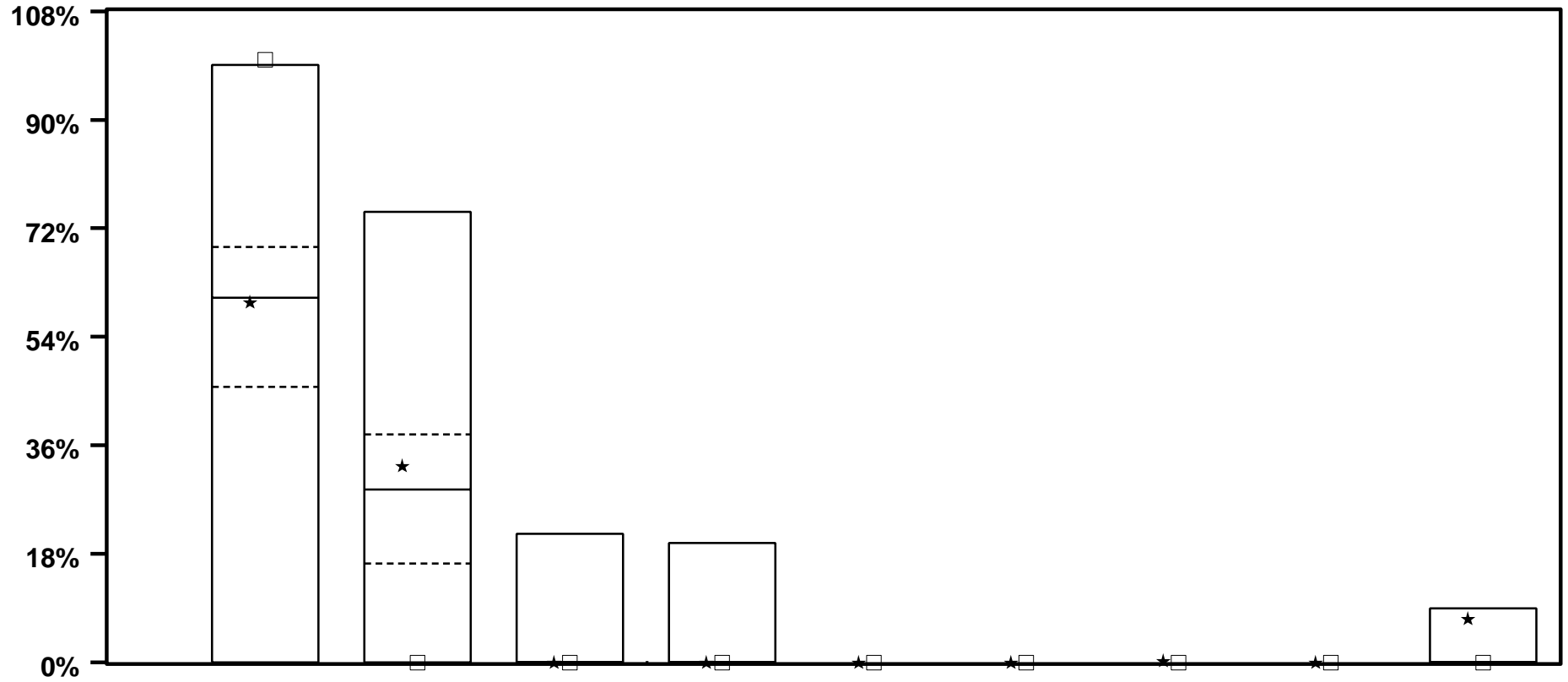

	EQUITY		BOND		BALANCED		HEDGE		VENTURE CAPITAL	PRIVATE DEBT	PRIVATE EQUITY	STABLE VALUE	REAL ESTATE	
★ MUNI COMPOSITE	59.8	51	32.6	37	0.0	12	0.0	25	0.0	0.0	0.3	0.0	7.2	7
□ EQTY COMPOSITE	100.0	1	0.0	86	0.0	12	0.0	25	0.0	0.0	0.0	0.0	0.0	20
MEDIAN	60.5		28.6		0.0		0.0						0.0	

VERMONT MUNICIPAL EMPLOYEES

PLAN ALLOCATION BY INVESTMENT MANDATE

AS OF 6/05

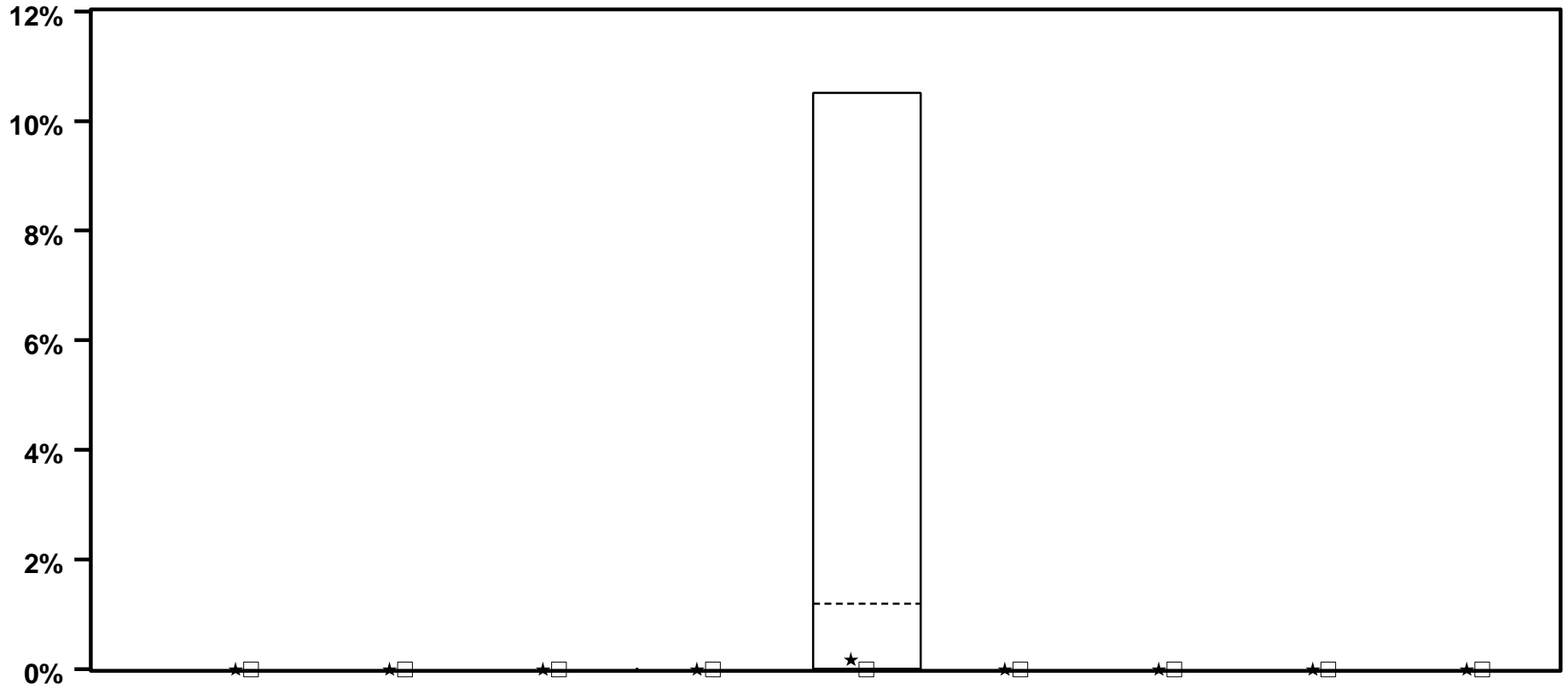

	TAAL	MORTGAGE	REIT	MISCE-LLANEOUS	TEMP INVEST	COMPANY STOCK	TAX-EXEMPT	IMMUNIZED	CONVERT-IBLE
★ MUNI COMPOSITE	0.0	0.0	0.0	0.0	0.2 41	0.0	0.0	0.0	0.0
□ EQTY COMPOSITE	0.0	0.0	0.0	0.0	0.0 50	0.0	0.0	0.0	0.0

MEDIAN

0.0

VERMONT MUNICIPAL EMPLOYEES

PLAN EQUITY ALLOCATION BY INVESTMENT MANDATE

AS OF 6/05

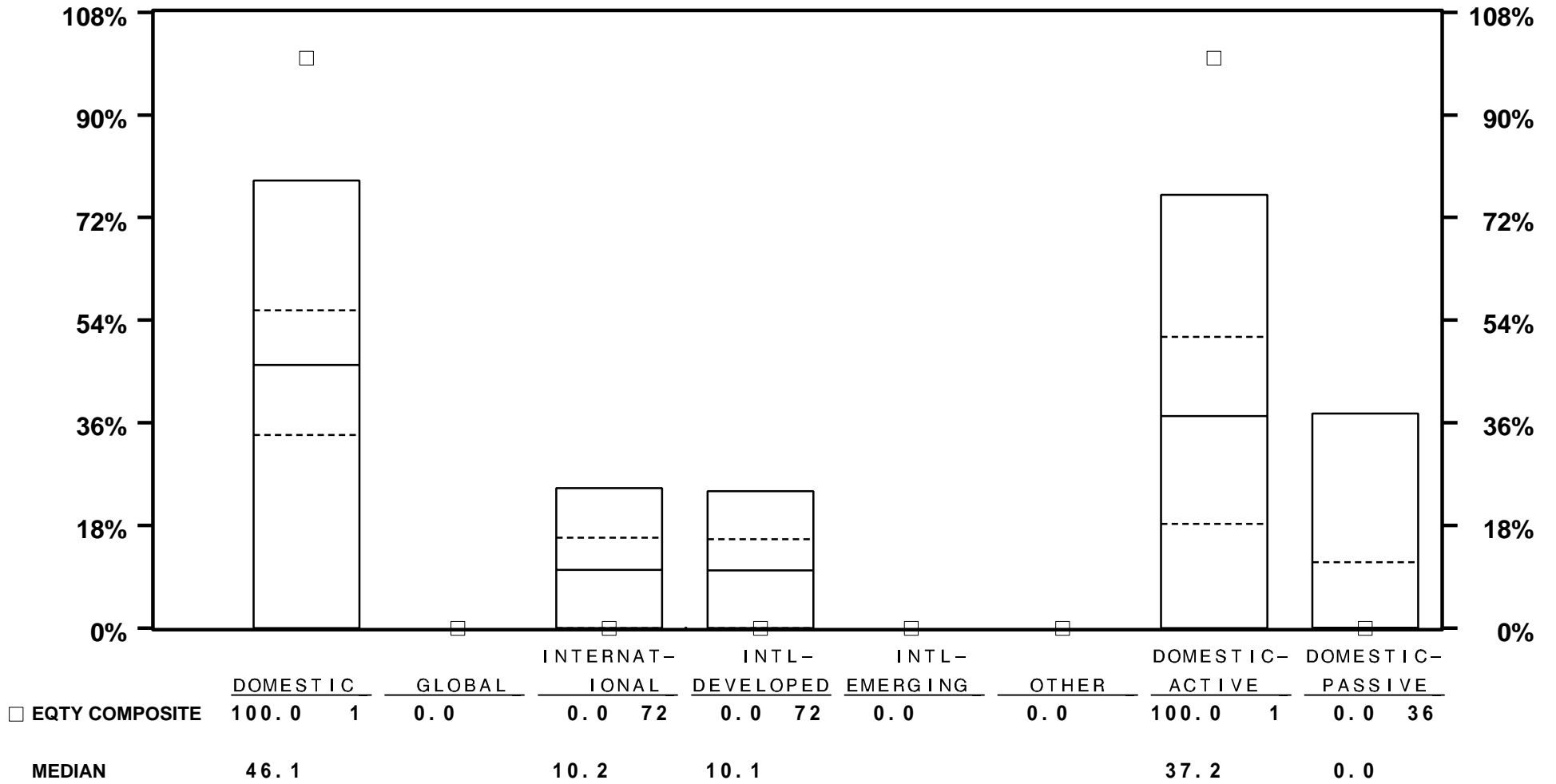

VERMONT MUNICIPAL EMPLOYEES

PLAN FIXED INCOME ALLOCATION BY INVESTMENT MANDATE

AS OF 6/05

